

National Studbook Bengal Tiger (*Panthera tigris tigris*) III Edition

Component of Central Zoo Authority sponsored project titled “Development and Maintenance of Studbooks for Selected Endangered Species in Indian Zoos” awarded to the Wildlife Institute of India vide sanction order: Central Zoo Authority letter no. 9-2/2012-CZA(NA)/418 dated 7th March 2012]

Published: March 2018



भारतीय वन्यजीव संस्थान
Wildlife Institute of India



केन्द्रीय चिड़ियाघर प्राधिकरण
Central Zoo Authority

National Studbook of Bengal Tiger **(*Panthera tigris tigris*) III Edition**

Published as a part of the Central Zoo Authority sponsored project titled
“Development and maintenance of studbooks for selected endangered species in Indian zoos”

PROJECT PERSONNEL

Research Assistant

Ms. Neema Sangmo Lama

Project Consultant

Anupam Srivastav, Ph.D.

Project Investigator

Dr. Parag Nigam

Copyright © WII, Dehradun, and CZA, New Delhi, 2018

Cover photo: Dr. Parag Nigam

This report may be quoted freely but the source must be acknowledged and cited as:

Wildlife Institute of India (2018) National Studbook of Bengal Tiger (*Panthera tigris tigris*) III Edition,
Wildlife Institute of India, Dehradun and Central Zoo Authority, New Delhi. TR.No. 2018/16 121 pages

For correspondence:

Project Investigator, Studbook Project,
Wildlife Institute of India,
PO Box 18, Dehradun, 248001
Uttarakhand, India

FOREWORD

Bengal tigers, the apex predators is a keystone species whose population has declined in recent past. Recent protection measures along with habitat management have resulted in significant recovery of the free ranging population however the threats that led to the decline in their population, remain operational.

Maintenance of viable *ex-situ* populations for ensuring their long-term persistence remains imperative. Effective *ex-situ* conservation of the species can be ensured by scientific management to ensure its long-term survival. This would require management interventions that ensure the maintenance of a genetically viable and demographically stable *ex-situ* population. Pedigree information contained in studbooks forms the basis for this management.

The Central Zoo Authority (CZA) in collaboration with zoos in India has initiated a conservation-breeding program for threatened species in Indian zoos. Bengal tiger is a part of the identified species under this initiative. As a part of this endeavour, a Memorandum of Understanding has been signed with the Wildlife Institute of India for compilation and update of studbooks of identified species in Indian zoos. As part of the project outcomes, the WII has compiled the National Studbook of Bengal tiger (*Panthera tigris tigris*) in Indian Zoos. The recommendations contained in the studbook would form the basis for the long-term management of the species in captivity.

It is hoped that all holding institutions will adopt the recommendations regarding pairing choices to be exercised to ensure retention of optimum genetic diversity in the captive population.

(Dr. D.N. Singh, I.F.S.)
Member Secretary
Central Zoo Authority

ACKNOWLEDGEMENTS

The studbook of Bengal tiger (*Panthera tigris tigris*) is a part of the assignment to the Wildlife Institute of India, Dehradun by the Central Zoo Authority, New Delhi for development and maintenance of studbooks of selected endangered species in Indian zoos.

The authors are thankful to the Central Zoo Authority for the financial support in carrying out the assignment. The guidance and support extended by Dr. D.N. Singh, IFS, Member Secretary, CZA is gratefully acknowledged. The authors also thank Dr. Brij Kishore Gupta, Evaluation and Monitoring Officer, Dr Devender Singh, Scientific Officer and the support staff of the Central Zoo Authority for facilitating this work.

The valuable advice and support provided by Dr. V.B. Mathur, Director, WII and Dr. G.S. Rawat, Dean Faculty of Wildlife Sciences, is duly acknowledged.

Authors sincerely acknowledge the support from the Directors, Veterinarians and other personnel from holding zoos (provided below) for providing pedigree information that led to the successful development of the studbook.

Alipore Zoological Garden, Kolkotta	Nahargarh Biological Park (Jaipur Zoo)
Arignar Anna Zoological Park, Chennai	Nandankanan Biological Park, Bhubneshwar
Assam State Zoo Cum Botanical Garden, Guwahati	Nandanvan Jungle Safari (Naya Raipur)
Aurangabad Municipal Zoo, Augangabad	National Zoological Park, Delhi
Bannerghatta Biological Park, Bengaluru	Nawab Wazid Ali Shah Zoological Garden, Lucknow
Bellary Zoo, Bellary	Nehru Zoological Park, Hyderabad
Bhagwan Birsa Biological Park, Ranchi	Padmaja Naidu Himalayan Zoological Park, Darjeeling
Biological Park, Itanagar	Pt. Govind Ballabh Pant High Altitude Zoo, Nainital
Bondla Zoo, Goa	Tiger & Lion Safari, Shimoga
Dr. K.Shivarma Karanth Piliikula Biological Park, Mangalore	Rajkot Municipal Zoo, Rajkot
Dr. Shyamaprasad Mukharjee Zoological Garden, , Surat	Sajjagarh Biological Park (Udaipur Zoo)
Gadag Zoo, Gadag	Sakkarbaug Zoo, Junagarh
Gandhi Zoological Park, Gwalior	Sanjay Gandhi Biological Park, Patna
Indira Gandhi Zoological Park, Vishakhapatnam	Sanjay Gandhi National Park and Zoo, Borivili
Maitri Baagh Zoo, Bhilai	Sayaji Baug Zoo, Vadodra
Jawaharlal Nehru Biological Park, Bokaro	Sepahijala Zoological Park, Agartala
Kamla Nehru Prani Sanghralhalaya Zoo, Indore	South Khairbari Rescue Centre, West Bengal
Kamla Nehru Zoological Garden, Ahmedabad	Sri Chamarajendra Zoological Gardens, Mysuru
Kanan Pandari Zoo, Raipur	Sri Venkateswara Zoological Park, Tirupati
Kanpur Zoological Park, Kanpur	State Museum & Zoo, Thrissur
Kota Zoo, Kota	Sundarban Wild Animal Park, Jharkali
Ludhiana Zoo, Ludhiana	Tata Steel Zoological Park, Jamdeshpur
Machia Biological Park (Jodhpur Zoo)	Thiruvananthapuram Zoo, Thiruvananthapuram
Maharaja Martand Singh Jedeo White Tiger Safari and Zoo, Rewa	Rajiv Gandhi Zoological Park and Wildlife Research Center, Pune
Maharajbag Zoo, Nagpur	Van Vihar National Park Zoo, Bhopal
Mahendra Chaudhury Zoological Park, Mohali	Veeramata Jijabai Bhosle Udyan & Zoo, Mumbai

Authors

CONTENTS

Species Biology: Bengal tiger (<i>Panthera tigris tigris</i>)	1
Status in Captivity	5
Methods	8
Scope of the Studbook	8
Analysis	10
Demographic Status	10
Genetic Status	11
Pairing Recommendations	12
Target for Population Management	14
Conclusions and Recommendations	15
References	16
Annexure I: Historical Population of Bengal Tiger (<i>Panthera tigris tigris</i>) in Indian Zoos	18
Annexure II: Bengal Tigers (<i>Panthera tigris tigris</i>) living in Indian Zoos	100
Annexure III: Location Glossary	121
Annexure IV: Pedigree Chart Report Bengal Tiger (<i>Panthera tigris tigris</i>)	(PDF in enclosed CD-Rom)

Species Biology: Bengal tiger (*Panthera tigris tigris*)

Tigers are members of the family felidae that inhabit varied habitat types in Asia and the Russian far-east. They are apex predators and act as both flagship and umbrella species. Thus, conservation of tigers ensures the protection of their habitats and the various components of biodiversity present along-with the maintenance of associated ecosystem services.

Kingdom:	Animalia
Phylum:	Chordata
Class:	Mammalia
Order:	Carnivora
Family:	Felidae
Sub-family:	Pantherinae
Genus:	<i>Panthera</i>
Species:	<i>tigris</i>
Sub-species:	<i>tigris</i>

Tigers are members of the mammalian order Carnivora with well developed olfactory lobes in the brain that is reciprocated by a cranial structure for keen olfactory sense. Further the highly developed carnassial that enable their predatory mode of life (Nowak and Nowak 2005). Similar to other felids they rely on their highly developed olfactory and auditory senses for their nocturnal predatory life. Their skull is round and short at the fore-end that allows them to deliver powerful bites that enable them to hunt large prey (Mazák 1981). Similar to other members of the sub-family Pantherinae the imperfectly ossified hyoid bone provides greater flexibility to the larynx thus enabling them to roar (Pocock 1917, Wozencraft 2005).

Eight subspecies of tiger (*Panthera tigris*), are traditionally recognized, of which three recently became extinct, are commonly recognized on the basis of geographic isolation and morphological characteristics (Mazák 1981). While Luo et al. (2004) suggested the segregation of extant tigers into six subspecies. A comparison of the traditionally recognized eight and the presently accepted six subspecies is presented below in table 1. The classification scheme at the sub-species level for tigers as proposed by Luo et al. (2004) has been accepted by the IUCN Redlist of threatened species (Goodrich et al. 2015) and the same is used here.

Table 1: Comparison of sub-species level classification and distribution of different tiger subspecies

Distribution range	Sub-species		Present status of populations
	Mazák 1981	Luo et al. 2004	
Indian sub-continent	<i>P. t. tigris</i>	<i>P. t. tigris</i>	Extant populations
Russian Far East and northeastern China	<i>P. t. altaica</i>	<i>P. t. altaica</i>	
South China	<i>P. t. amoyensis</i>	<i>P. t. amoyensis</i>	
Sumatra	<i>P. t. sumatrae</i>	<i>P. t. sumatrae</i>	
Indochina north of the Malayan Peninsula	<i>P. t. corbetti</i>	<i>P. t. corbetti</i> I	
Malayan peninsula	--	<i>P. t. corbetti</i> II (<i>P. t. jacksoni</i>)	
Bali	<i>P. t. balica</i>		Extinct populations (Nowell and Jackson 1996)
Eastern Anatolia, Iran, Caucasus region and Central Asia	<i>P. t. virgata</i>		
Java	<i>P. t. sondaica</i>		

Biology

General Characteristics/Morphology

The body structure of tigers is similar to other members of the family Felidae with well developed, powerful forequarters (Mazák 1981). The background colour of the pelage on the dorsal, lateral and head parts ranges from varying shades of orange interspersed with dark bands. The pelage on the ventral surface is white. Besides this three other pelage color variants: white, golden and stripeless snow white have also been reported (Xu 2017) and melanistic variants with varying degrees of black in their pelage (Swain and Behera 2013). The stripe pattern of each tiger is unique and used for individual animal identification (Hiby et al. 2009).

Table 2: Biological attributes of Bengal Tiger (Various sources)

Attributes	Males	Females
Body length	270-310 cm	240-265 cm
Body weight	175-260 kg	100-160 kg
Age at first reproduction (free ranging)	4.8 years (mean)	3.8 years (mean)
Age at first reproduction (in captivity)	2.5 years	2.5 years
Longevity	12-15 years in wild; 20 years or more in captivity	
Gestation period	106 -112 days	
Litter size	Ranging from 1 – 7 cubs (mostly 2-4)	

The species shows digitigrades locomotion with the forelimb having five digits and the hind limb having four. The pollex (thumb) in the forelimb is raised and does not touch the ground while the hallux (thumb) in the hind limb is altogether absent. All toes bear retractable claws that are used for aggression (Mazak 1981).

Habitat Ecology

The sub-species *Panthera tigris tigris* inhabits varied landscapes in the Indian subcontinent that range from the hot and dry thorn forests in Sariska and Ranthambore Tiger Reserves to the humid tidal mangroves in Sunderbans (Sunquist 2010). The Indian subcontinent has been divided into five landscapes based on bio-geographical considerations (Jhala et al. 2015). The landscapes and the major vegetation types present in each based on Champion and Seth (1968) is presented in table 3.

Table 3: Landscapes and vegetation types in Indian subcontinent inhabited by tigers

Landscape	Vegetation types
Shivalik Hills and Gangetic plains	Moist Shivalik Sal Forest, Dry Deciduous Scrub and grassland, Dry Plains Sal Forest, Northern Dry Mixed deciduous forest, West Gangetic Moist Deciduous Forest and Plantation
Central India and Eastern Ghats	Dry Teak Forest, Moist Peninsular Sal Forest, Dry Deciduous Scrub and Grassland, <i>Anogeissus pendula</i> and <i>Boswellia</i> Forest, Southern Dry Mixed Deciduous Forest, Northern Dry Mixed Deciduous Forest and Southern Moist Mixed Deciduous Forest
Western Ghats	Tropical Evergreen Forest, West Coast Semi Evergreen Forest, Moist Evergreen Forest, Slightly Moist Teak Forest, Moist Deciduous Forest, Dry Deciduous Scrub Forest, Dry Semi-Deciduous Forest and Grasslands
North Eastern Hills and Brahmaputra Flood Plains	East Himalayan Moist Mixed Deciduous Forest, East Himalayan Mixed Coniferous Forest and Assam Alluvial plains Semi-Evergreen Forest
Sundarbans	Mangrove forests

Source: Jhala et al. (2015)

The space use patterns of female tigers are regulated by availability of resources, while that of males are determined by female space use (Macdonald 1983). Home ranges of male Bengal tigers range from 25.7 km² in resource rich Nagarhole Tiger Reserve to 188.6 km² in Panna Tiger Reserve, while those of females range from 9.3 km² in Chitwan National Park, Nepal to a high of 202.4 km² in Sariska Tiger Reserve (Majumder et al. 2012).

They are opportunistic predators hunting on a diverse prey base that includes sambar (*Rusa unicolor*), chital (*Axis axis*), barasingha/swamp deer (*Rucervus duvaucelii*), wild boar (*Sus scrofa*), hog deer (*Axis porcinus*), barking deer (*Muntiacus muntjak*), nilgai/blue bull (*Boselaphus tragocamelus*), chousingha (*Tetracerus quadricornis*), chinkara (*Gazella bennettii*), black buck (*Antelope cervicapra*), gaur (*Bos gaurus*), wild buffalo (*Bubalus bubalis*) serow (*Naemorhedus sumatraensis*), porcupine (*Hystrix indica*), Hanuman langur (*Semnopithecus entellus*), rhesus macaque (*Macaca mulata*), bonnet macaque (*Macaca radiata*), peafowl (*Pavo cristatus*) and calves of rhinoceros (*Rhinoceros unicornis*) and elephant (*Elephas maximus*). They have also been reported to kill other carnivores like sloth bear (*Melurus ursinus*), crocodile (*Crocodylus* spp), scaly anteater (*Manis crassicaudata*) leopard (*Panthera pardus*) and dholes (*Cuon alpinus*). Apart from the wild prey, domestic cattle constitute a large part of their diet (Mazák 1981).

Behaviour

Though the tiger is a solitary and nocturnal predator; temporary association between a mating pair and comparatively prolonged association between mother and offspring are the only social phases of a

tiger's life (Schaller, 1967). They exhibit a variety of land tenure patterns, that include defended territories, shared overlapping ranges, animals without established ranges (dispersing and old animals) Schaller (1967). A variety of scent and visual signals are used to mark territories. These include spraying urine, leaving their scats in conspicuous piles, and scrape marks on tree trunks and the ground (Schaller, 1967).

Reproductive behaviour of tigers is similar to other large felids; the estrous female advertises her receptivity by auditory and olfactory cues to which nearby males respond. They copulate frequently during this temporary bond lasting 5 – 7 days after which the males move away. Parental care is provided entirely by the females and the cubs on reaching adulthood disperse (Mazák 1981).

Distribution

The subspecies is distributed across India, Nepal, Bhutan and Bangladesh (Chundawat et al. 2011). In Nepal tigers are present in areas bordering the Shivalik Hills and Gangetic plains on the Indian side. In Bhutan they are contiguous with Upper Bengal Douars, north-eastern hill region in the State of Assam and Arunachal Pradesh. While in Bangladesh they are present in the mangrove areas of the Sundarbans (Goodrich et al. 2015). In India they are present in 17 states with high density populations reported from Uttarakhand, Tamil Nadu, Maharashtra and Karnataka (Chundawat et al. 2011; Jhala et al. 2015).



Figure 1: Distribution of Panthera tigris tigris (Goodrich et al. 2015)

Table 4: Distribution of Bengal tigers in India

Landscape	Range States in India
Shivalik Hills and Gangetic plains	Uttarakhand, Uttar Pradesh, Nepal and Bihar
Central India and Eastern Ghats	Semi-arid zone of Rajasthan, central Indian plateau and includes parts of the Eastern Ghats. Parts of the Northern Western Ghats (Sahyadri) in Maharashtra
Western Ghats	Nagarhole-Bandipur-Mudumalai-Wayanad-BRTSatyamangalam complex in the states of Karnataka, Tamil Nadu and Kerala
North Eastern Hills and Brahmaputra Flood Plains	Upper Bengal Douars, the Brahmaputra flood plains and north-eastern hill region in the States of Assam, Arunachal Pradesh, Mizoram and northern part of West Bengal
Sundarbans	Estuarine phase of Ganges and Brahmaputra river system in the state of West Bengal

Threats

Tigers across their distribution range are threatened by extensive poaching, habitat destruction as a consequence of development of linear infrastructure. The development of linear infrastructure is also responsible for fragmentation of populations leading to reduced gene-flow between populations (Goodrich et al. 2015; Natesh et al. 2017).

Threats in captivity

In captivity, tigers are susceptible to infectious and non-infectious diseases. Records of disease outbreaks, mainly feline-panleucopenia, trypanosomiasis, babesiosis and non specific renal and hepatic disorder have been reported. Besides this, efforts to breed white tigers with high exhibit value but low genetic diversity also threaten the *ex-situ* conservation of tigers.

Conservation Status

The efforts for the conservation of tiger in India started with the Project Tiger in 1972. It is protected under the Schedule I, Part I of the Wildlife Protection Act, 1972, listed as endangered under IUCN Red data list (Chundawat et al. 2011; Goodrich et al. 2015), and is placed under Appendix I of CITES. Together these efforts have resulted in an increase in tiger population in India from an estimated 1411 in 2006 to 1706 as concluded in 2010 tiger census report. While the estimates for the period 2013 – 2014 indicate the presence of 2226 tigers with a range of 1945 to 2491 (Jhala et al. 2015) in an area of approximately 71027.10 km² spread across 50 tiger reserves.

Status in Captivity

The Central Zoo Authority inventory of animals records the presence of 371 (180.179.12) tigers in 51 Indian zoos; of these 120 (54.61.5) are white tigers held at 25 zoos. The Species360 website records the presence of 191(89.102.0) specimens at 25 Indian zoos. It also documents the presence of 352 (172.179.1) specimens at 75 institutions globally spread across 5 regions. The regional distribution of tigers in captive facilities globally, according to the ‘Species

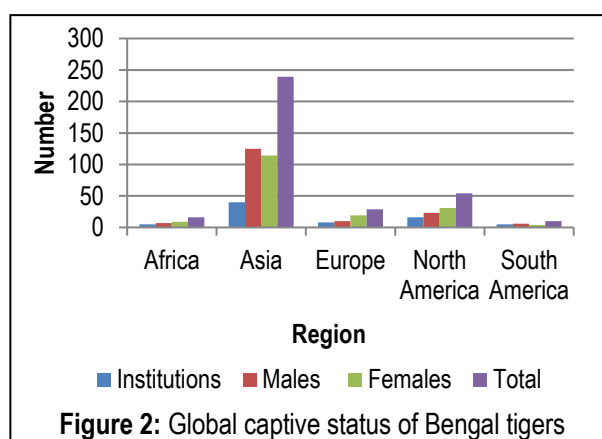

Figure 2: Global captive status of Bengal tigers

holding report of ZIMS’ is presented as figure 2. A comparison of the holding pattern in Indian zoos based on Species360 website, CZA Inventory (2016 – 2017) and data made available by holding institutions for the development of studbooks is summarized in table 5, while table 6 presents a comparison of the holding pattern of white tigers (Bengal) in Indian zoos based on CZA Inventory (2016 – 2017) and data made available by holding institutions for the development of studbooks

Table 5: Status of Bengal tigers in Indian zoos

Zoo Name	Species360				CZA Inventory (2016 – 2017)				Studbook			
	Male	Female	Unsexed	Total	Male	Female	Unsexed	Total	Male	Female	Unsexed	Total
Alipore Zoological Garden	--	--	--	--	1	4	0	5	4	8	0	12
Arignar Anna Zoological Park	7	14	0	21	5	10	0	15	8	15	0	23
Assam State Zoo Cum Botanical Garden	1	4	0	5	1	3	0	4	2	5	0	7

Zoo Name	Species360				CZA Inventory (2016 – 2017)				Studbook			
	Male	Female	Unsexed	Total	Male	Female	Unsexed	Total	Male	Female	Unsexed	Total
Aurangabad Municipal Zoo	--	--	--	--	3	4	0	7	7	6	0	13
Bannerghatta Biological Park	4	0	0	4	15	11	0	26	22	22	0	44
Bellary Zoo	--	--	--	--	--	--	--	--	1	0	0	1
Bhagwan Birsa Biological Park	3	2	0	5	2	1	0	3	2	1	0	3
Biological Park, Itanagar	4	5	0	6	4	3	0	7	4	2	0	6
Bondla Zoo	--	--	--	--	1	0	0	1	--	--	--	--
Dr. K.Shivarma Karanth Piiilkula Biological Park	9	1	0	10	9	2	0	11	12	4	0	16
Dr. Shyamaprasad Mukharjee Zoological Garden	1	1	0	2	2	1	0	3	1	2	0	3
Gadag Zoo	--	--	--	--	--	--	--	--	0	1	0	1
Gandhi Zoological Park	--	--	--	--	2	3	0	5	0	2	0	2
Indira Gandhi Zoological Park	--	--	--	--	0	2	0	2	6	10	0	16
Jawaharlal Nehru Biological Park	--	--	--	--	--	--	--	--	2	4	0	6
Kamla Nehru Prani Sanghralhalaya Zoo	3	1	0	4	3	1	0	4	9	3	0	12
Kamla Nehru Zoological Garden	1	1	0	1	1	1	0	2	1	1	0	2
Kanan Pandari Zoo	--	--	--	--	1	4	0	5	0	3	0	3
Kanpur Zoological Park	7	4	0	11	1	1	3	5	8	3	3	14
Kota Zoo	--	--	--	--	0	1	0	1	2	0	0	2
Ludhiana Zoo	--	--	--	--	2	0	0	2	2	3	0	5
Machia Biological Park (Jodhpur Zoo)	--	--	--	--	--	--	--	--	0	1	0	1
Maharaja Martand Singh Jedeo White Tiger Safari and Zoo	--	--	--	--	2	2	0	4	2	3	0	5
Maharajbag Zoo	--	--	--	--	0	3	0	3	--	--	--	--
Mahendra Chaudhury Zoological Park	7	5	0	12	3	2	0	5	10	4	0	14
Maitri Baagh Zoo	--	--	--	--	2	1	0	3	7	4	0	11
Nagaland Zoological Park, Rangapahar	--	--	--	--	1	1	0	2	--	--	--	--
Nahargarh Biological Park (Jaipur Zoo)	--	--	--	--	1	1	0	2	3	1	0	4
Nandankanan Biological Park	3	3	0	6	8	9	0	17	16	13	0	29
Nandanvan Jungle Safari (Naya Raipur)	--	--	--	--	2	3	0	5	2	2	0	4
National Zoological Park	5	7	0	12	3	2	0	5	9	8	0	17
Nawab Wazid Ali Shah Zoological Garden	6	4	0	10	4	3	0	7	7	5	0	12
Nehru Zoological Park	9	4	0	13	4	5	0	9	15	8	0	23
North Bengal Wild	--	--	--	--	1	1	0	2	--	--	--	--

Zoo Name	Species360				CZA Inventory (2016 – 2017)				Studbook			
	Male	Female	Unsexed	Total	Male	Female	Unsexed	Total	Male	Female	Unsexed	Total
Animals Park												
Padmaja Naidu Himalayan Zoological Park	1	0	0	1	1	2	0	3	1	0	0	1
Pt. Govind Ballabh Pant High Altitude Zoo	1	1	0	2	0	1	0	1	1	2	0	3
Rajiv Gandhi Zoological Park And Wildlife Research Center	2	2	0	4	2	2	0	4	2	3	0	5
Rajkot Municipal Zoo	2	9	0	11	1	2	0	3	2	9	0	11
Sajjangarh Biological Park (Udaipur Zoo)	--	--	--	--	1	1	0	2	1	3	0	4
Sakkarbaug Zoo	2	4	0	6	1	3	0	4	7	3	0	10
Sanjay Gandhi Biological Park	2	4	0	6	1	1	1	3	2	5	0	7
Sanjay Gandhi National Park And Zoo	--	--	--	--	3	3	0	6	5	7	0	12
Sayaji Baug Zoo	--	--	--	--	1	2	0	3	1	2	0	3
Sepahijala Zoological Park	1	0	0	1	1	0	0	1	--	--	--	--
South Khairbari Rescue Centre	--	--	--	--	1	0	0	1	--	--	--	--
Sri Chamarajendra Zoological Gardens	10	4	0	14	10	3	0	13	11	6	0	17
Sri Venkateswara Zoological Park	7	5	0	12	1	2	3	6	6	7	0	13
State Museum & Zoo	--	--	--	--	3	0	0	3	1	0	0	1
Sundarban Wild Animal Park, Jharkali	--	--	--	--	1	0	0	1	--	--	--	--
Tata Steel Zoological Park	--	--	--	--	1	3	0	4	3	4	0	7
Thiruvananthapuram Zoo	--	--	--	--	5	1	0	6	6	5	0	11
Tiger & Lion Safari	--	--	--	--	5	2	0	7	7	5	0	12
Van Vihar National Park Zoo	3	6	0	9	3	5	0	8	2	6	0	8
Veermata Jijabai Bhosle Udyan & Zoo	1	1	0	2	--	--	--	--	--	--	--	--
Total	102	89	0	191	126	118	7	251	218	215	3	436

Table 6: Status of White tigers in Indian Zoos (Part of 218.215.3 (436) tigers)

Zoo Name	CZA Inventory (2016 – 2017)			
	Male	Female	Unsexed	Total
Alipore Zoological Garden	2	2	0	4
Arignar Anna Zoological Park	4	7	0	11
Assam State Zoo Cum Botanical Garden	0	2	0	2
Aurangabad Municipal Zoo	2	0	0	2
Bannerghatta Biological Park	3	4	0	7
Indira Gandhi Zoological Park	2	3	0	5
Jawaharlal Nehru Biological Park	0	1	0	1
Kanan Pandari Zoo	4	3	0	7
Kanpur Zoological Park	1	1	0	2
Mahendra Chaudhury Zoological Park	1	1	0	2
Maitri Baagh Zoo	5	3	0	8
Nahargarh Biological Park (Jaipur Zoo)	1	1	0	2
Nandankanan Biological Park	4	5	0	9
National Zoological Park	2	5	0	7
Nawab Wazid Ali Shah Zoological Garden	3	1	0	4
Nehru Zoological Park	9	3	0	12
Rajiv Gandhi Zoological Park And Wildlife Research Center	2	1	0	3
Rajkot Municipal Zoo	1	7	0	8
Sakkarbaug Zoo	1	1	0	2
Sanjay Gandhi Biological Park	1	2	1	4
Sanjay Gandhi National Park And Zoo	1	0	0	1
Sri Chamarajendra Zoological Gardens	0	1	0	1
Sri Venkateswara Zoological Park	4	6	4	14
Tata Steel Zoological Park	1	0	0	1
Van Vihar National Park Zoo	0	1	0	1
Total	54	61	5	120

Methods

Data on individual history was collected by means of questionnaires, zoo visits and from the websites of CZA and Species360. Questionnaires were sent to the institutions housing Bengal tiger in India, requesting information for each captive specimen. Data was entered in the Single Population Analysis and Records Keeping System (SPARKS v 1.66) (ISIS 2004) and subsequently exported to population management programme PMx v 1.2 (Ballou et al., 2011) for further analysis. The specimens of normal coat colour and those carrying the white gene were segregated based on request of the Central Zoo Authority. Population management plans and breeding recommendations are provided separately for both.

Scope of the Studbook

- The CZA inventory (2016 – 2017) was used as a benchmark for population estimates and deviations from the same (Tables 5 and 6) are attributed to non-availability of required information from holding institutions though repeated requests for the same were made.
- The studbook includes all specimens present in Indian zoos for which records were available from holding institutions. Efforts were made to retrieve information on their holding from the taxon report of the species from the Species360 website for institutions from which records

were not received. The 40th Edition of the 'International Studbook of Tigers' (2015) compiled by Dr. Peter Muller was also used as a benchmark.

- The studbook numbers in the current edition of the studbook have been reassigned in a chronological order. The old studbook numbers used in the II Edition of the National Studbook of Bengal tigers are included in the remarks column. International studbook numbers as mentioned in the 'International Studbook of Tigers' (2015 edition) have also been included in a separate column as an additional identifier to minimize confusion.
- Specimens with a white phenotype and those carrying the white gene have been identified as white in the remarks column of the table providing details of the historical population as well as the living population (Annexures I and II respectively).
- Based on the request of the Central Zoo Authority the studbook segregates the breeding recommendations for specimens carrying the gene for normal coat colour and animals that are white or carry the white gene.
- Specimens for which information was not available from the various data sources accessed and reported as living, though of extended longevity in the II Edition of the National Studbook have been listed as 'lost to follow up' (LTF) based on the International Studbook of Bengal Tiger (2015).
- The mnemonics present in the SPARKS software were used as names for individual institutions; while for those institutions for which mnemonics were not present in the SPARKS Software, the same were assigned based on the states they were located in and the same are listed in the location glossary (Annexure IV).

Analysis

Overall Population

Demographic Status

Historical Population

The historical population Bengal tiger in Indian Zoos consists of 1697 (785.872.40) specimens. This includes 163(82.79.2) wild origin individuals. The first animal a wild origin white tiger male was housed at Rewa in 1950, subsequently a female was acquired in 1951. The census trends of the population (Figure 3) reveal that its growth has been largely due to captive births with 90% of the population born in zoos. The population also

includes 138 (63.72.3) animals whose fate could not be ascertained from the data made available by the holding institutions and the 'taxon report' of the animal obtained from Species360 website. These animals are considered as lost to follow up in the current addition of the studbook. Details on individual specimens are summarized in Annexure I (Historical population of Bengal tigers in Indian Zoos) and Annexure III (Pedigree charts reports). White tigers and animals carrying the white gene have white tiger listed against their name in Annexure I.

Living Population

The living population includes 436 (218.215.3) specimens housed at 50 zoos in the country. These include 40 (23.17.0) wild origin animals. The population

consist of approximately 90% of individuals born in zoos. Approximately 21% of the living population is reproductively active. The population additionally has an equitable sex ratio. Table 4 summarizes the status of the living population while Annexure II provides location wise listing of individual animals.

Population Vital Rates

The captive population has reached equilibrium and has a marginal rate of growth. The population has a generation time of 8.6 years that limits loss of

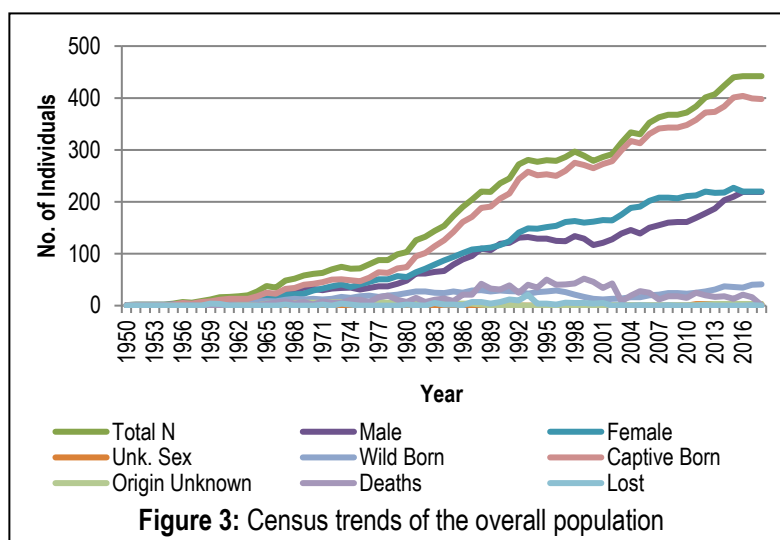

Table 7: Summary of the Historical Population

	Males	Females	Unknown	Total
Studbook size	785	872	40	1697
Acquisition from wild	82	79	2	163
Captive born	703	793	38	1534
Deaths	567	657	37	1251
Breeding individuals	181	199	0	380
Lost to follow up/ released	63	72	3	138

Table 8: Summary of living population

	Males	Females	Unknown	Total
Living	218	215	3	436
Wild-born	23	17	0	40
Captive-born	195	198	3	396
Breeding individuals	46	46	0	92

Table 9: Vital rates of the captive population

	Males	Females	Total
λ: Population growth rate	1.034	1.013	1.024
T: Generation time	8.6 years	8.1 years	8.4 years
N 20: Projected status after 20 years	208	206	414

genetic diversity with each subsequent generation. The population is projected to decline marginally over the next 20 years, with a decrease of 5 individuals in the population.

Age Distribution:

Age distribution of 436 (218.215.3) known age and sex living specimens indicates an equitable distribution of both sexes. The age distribution of the overall population (Figure 4) shows only a limited number of individuals that have reached reproductively senescence or are yet to become reproductively mature. The age distribution suggests that almost the entire population is in the reproductively active age classes; however, the population includes only 92 (46.46) animals that are proven breeders (Table 8). The presence of an equal number of animals across age classes suggest that population is demographically stable and capable of rapid growth if required.

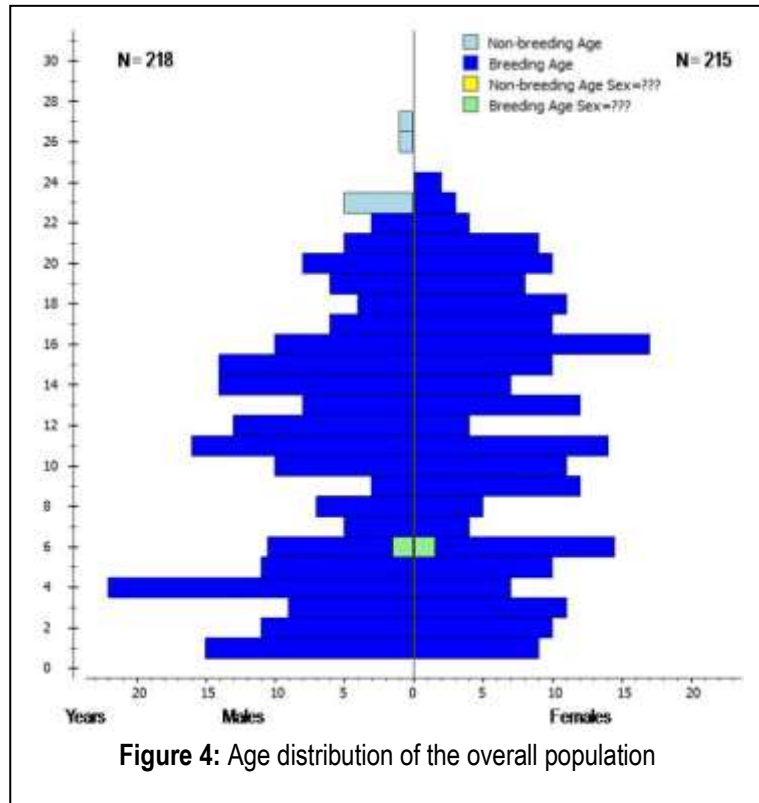

Figure 4: Age distribution of the overall population

Genetic Status

The living population of 436 (218.215.3) specimens can be traced to 40 founders. The population retains approximately 91% of the genetic diversity of these 40 founders. A cause for concern; however, are the high values of population mean kinship and mean inbreeding. These indicate that pairing choices have been inappropriately made and that individuals in the population range from being step-children to first cousins. The low value of founder genome equivalents indicates overrepresentation of a few lineages; a factor that is responsible for the high values of population mean kinship and mean Inbreeding. The presence of a significant proportion of specimens of unknown ancestries (20%); however, limits an accurate assessment of the genetic status of the population.

Table 10: Genetic status of the current population

Genetic parameters	Current
Founders	40
Living Animals	436
Percent Ancestry Known	80
Gene Diversity (GD)	91%
Population mean kinship (Mk)	0.0898
Mean Inbreeding	0.2018
Ne/N	0.2197
Founder genome equivalents	5.57

Pairing Recommendations

The pairing recommendations for Bengal tigers in Indian zoos have been segregated into two based on the request of Central Zoo Authority. The pairing recommendations presented here are based on a change in the genetic diversity (dGD) and inbreeding coefficient (F) of pairs identified for pairing. The pairing recommendations have been made for all specimens in the reproductively active age classes, these included all specimens of known sex below 12 years of age (reproductive activity shows a sharp decline in animals above 12 years).

Pairing Recommendations for Bengal tigers carrying the gene for normal coat colour

Living specimens having a normal coat colour phenotype and carrying the gene for normal coat colour were identified from the pedigree charts and descendant lists of individual specimens. Hypothetical pairings were carried out for all living specimens in reproductively active age classes using PMx. The matrix generated was then analyzed for selecting pairings that led to a maximum gain in genetic diversity due to increases in 'dGD' and lowest 'F'. An additional consideration used to decide on pairing choices was the distances the animals would need to be moved in implementing the pairing choices. Table 11 summarizes the pairing recommendations for animals carrying the gene for the normal coat colour. The pairing recommendations suggested will lead to a gain of approximately 1.6% in genetic diversity retained by the captive population.

Table 11: Pairing recommendations for Bengal tigers carrying the gene for normal coat colour

Dam	Dam Location	Sire	Sire Location	F	dGD
1383	RAIPUR	1623	AURANGABA	0	0.049
1416	CHATBIR Z	1607	KANPUR	0	0.0474
1417	DELHI	1618	INDORE	0	0.0486
1420	BANNERGHA	1650	BANNERGHA	0	0.0497
1432	NANDANKAN	1631	MANGALORE	0	0.0472
1435	ITANAGAR	1720	ASSAM	0	0.0506
1438	TRIVANDRU	1688	MYSORE	0	0.0476
1445	SHIMOGA	1520	MYSORE	0	0.0377
1450	MANGALORE	1578	BANNERGHA	0	0.0424
1451	MANGALORE	1615	MYSORE	0	0.0477
1452	NAINITAL	1569	LUCKNOW	0	0.0409
1456	VANVIHAR	1634	VANVIHAR	0	0.0466
1457	ASSAM	1594	ITANAGAR	0	0.0441
1474	TIRUPATI	1498	SHIMOGA	0	0.0362
1481	GADAG	1650	BANNERGHA	0	0.0499
1488	VANVIHAR	1643	INDORE	0	0.0484
1500	NAINITAL	1712	NAINITAL	0	0.0502
1506	PUNE	1649	PUNE	0	0.0491
1536	BHILAI	1703	AURANGABA	0	0.049
1565	TATA	1684	NANDANKAN	0	0.0471
1591	MYSORE	1642	MYSORE	0	0.0478
1593	ITANAGAR	1434	ITANAGAR	0	0.028

Dam	Dam Location	Sire	Sire Location	F	dGD
1596	LUCKNOW	1706	LUCKNOW	0	0.0496
1614	MADRAS	1680	MANGALORE	0	0.0489
1619	ASSAM	1433	ITANAGAR	0	0.0265
1622	REWA	1595	VANVIHAR	0	0.0459
1641	TATA	1537	DELHI	0	0.0411
1651	MYSORE	1679	MANGALORE	0	0.0498
1655	VANVIHAR	1519	RAIPUR	0	0.0373
1672	AURANGABA	1700	INDORE	0	0.0488
1673	AURANGABA	1681	MANGALORE	0	0.0477
1691	VANVIHAR	1621	REWA	0	0.049
1702	AURANGABA	1546	SURAT	0	0.0406
1704	LUCKNOW	1602	NANDANKAN	0	0.0473
1718	MYSORE	1629	MANGALORE	0	0.0483
1719	MYSORE	1682	MANGALORE	0	0.0466
Change in Genetic diversity					1.6326

Pairing recommendations for Bengal tigers carrying the gene for white coat colour

Pairing recommendations for animals that have a white phenotype or carry the gene for white coat colour were arrived at in a similar manner as described above for normal colour tigers for animals that had a white phenotype or carried the white coat colour gene. Table 12 summarizes pairing recommendations for animals that have a white phenotype or carry the gene for white coat colour. Since the expression of white colour is an outcome of the presence of recessive genes a loss of genetic diversity retained by the population is inevitable; however while making the recommendations efforts made to ensure that lowest possible, decrease in 'dGD' and increase in 'F' occurred as a result of the pairing choices suggested.

The pairing recommendations if implemented as suggested would lead to an increase in Mean Inbreeding by 0.0462 and loss of approximately 1.02% of the genetic diversity retained by the population. Pairing choices other than that suggested may lead to further erosion in genetic diversity of the population.

Table 12: Pairing recommendations for Bengal tigers carrying the gene for white coat colour

Dam	Dam Location	Sire	Sire Location	F	dGD
1349	LUCKNOW	1336	JUNAGADH	0.0608	-0.0095
1352	CHATBIR Z	1337	KANPUR	0.0599	-0.0198
1354	TIRUPATI	1715	KANPUR	0.0162	-0.02
1357	VISAKAPAT	1692	NANDANKAN	0.0139	-0.0162
1359	JUNAGADH	1714	KANPUR	0.0635	-0.0129
1362	KANPUR	1601	DELHI	0.0299	-0.0121
1375	CALCUTTA	1662	KANPUR	0.0301	-0.0114
1380	MADRAS	1600	MYSORE	0.0293	-0.0113
1392	JUNAGADH	1612	HYDERABAD	0.0469	-0.0112

1406	RAJKOT	1442	JAIPUR	0.0596	-0.0133
1407	VADODARA	1391	VADODARA	0.0572	-0.014
1408	VADODARA	1390	RAJKOT	0.0572	-0.0149
1422	BHILAI	1401	PATNA	0.0288	-0.0166
1428	HYDERABAD	1715	KANPUR	0.0162	-0.0172
1443	BILASPUR	1668	RAIPUR	0.0369	-0.0169
1444	DELHI	1529	DELHI	0.0293	-0.0169
1453	TRIVANDRU	1355	HYDERABAD	0.0266	-0.0172
1462	BANNERGHA	1427	TIRUPATI	0.0186	-0.0199
1469	NANDANKAN	1358	JUNAGADH	0.0599	-0.0205
1476	BORIVILLI	1657	DELHI	0.0465	-0.0199
1483	PATNA	1598	MYSORE	0.0583	-0.0227
1490	MADRAS	1425	HYDERABAD	0.0621	-0.0232
1491	MADRAS	1599	MYSORE	0.0316	-0.0246
1495	VISAKAPAT	1600	MYSORE	0.0494	-0.0244
1496	VISAKAPAT	1570	CHATBIR Z	0.0589	-0.0242
1501	NANDANKAN	1713	KANPUR	0.0516	-0.0252
1507	CHATBIR Z	1376	AHMEDABAD	0.0486	-0.0263
1510	TIRUPATI	1475	BORIVILLI	0.0372	-0.0261
1514	MADRAS	1580	HYDERABAD	0.0645	-0.0268
1522	VISAKAPAT	1636	NANDANKAN	0.0139	-0.0267
1545	RANCHI	1424	CALCUTTA	0.0612	-0.0306
1561	HYDERABAD	1685	HYDERABAD	0.0373	-0.0335
1562	NANDANKAN	1675	MADRAS	0.0569	-0.0327
1563	NANDANKAN	1613	HYDERABAD	0.0373	-0.0321
1571	RAIPUR	1597	RANCHI	0.0576	-0.0316
1584	MADRAS	1652	HYDERABAD	0.0645	-0.0316
1588	MADRAS	1321	BORIVILLI	0.0612	-0.0317
1611	HYDERABAD	1624	TRIVANDRU	0.0645	-0.032
1626	PATNA	1389	JUNAGADH	0.0544	-0.0325
1658	DELHI	1581	HYDERABAD	0.0645	-0.0318
1669	KANPUR	1677	MADRAS	0.0373	-0.0351
1678	MADRAS	1423	DARJEELIN	0.0587	-0.0347
1686	HYDERABAD	1582	MADRAS	0.0645	-0.0343
1716	KANPUR	1693	NANDANKAN	0.049	-0.0343
Change in Genetic diversity					-1.0204

Target for Population Management

The current captive population of Bengal tigers in Indian zoos includes 437 (218.216.3) individuals. It includes 40 (23.17) effective founders. The population is currently growing with a λ of 1.024 per annum. The population retains a significant proportion (91%) of the genetic diversity sampled from the large founder base. A significant proportion of the population; however, includes closely related individuals (Mean Inbreeding: 0.2018 and Population mean kinship: 0.898).

A simulation was run using PMx to assess the future fate of the current population. The variables used for the simulation were the current population demographic and genetic characteristics. The outcome indicates that the population in captivity is likely to retain the current demographic characteristics; it would however lose approximately 6% of its current genetic diversity over the next 100 years.

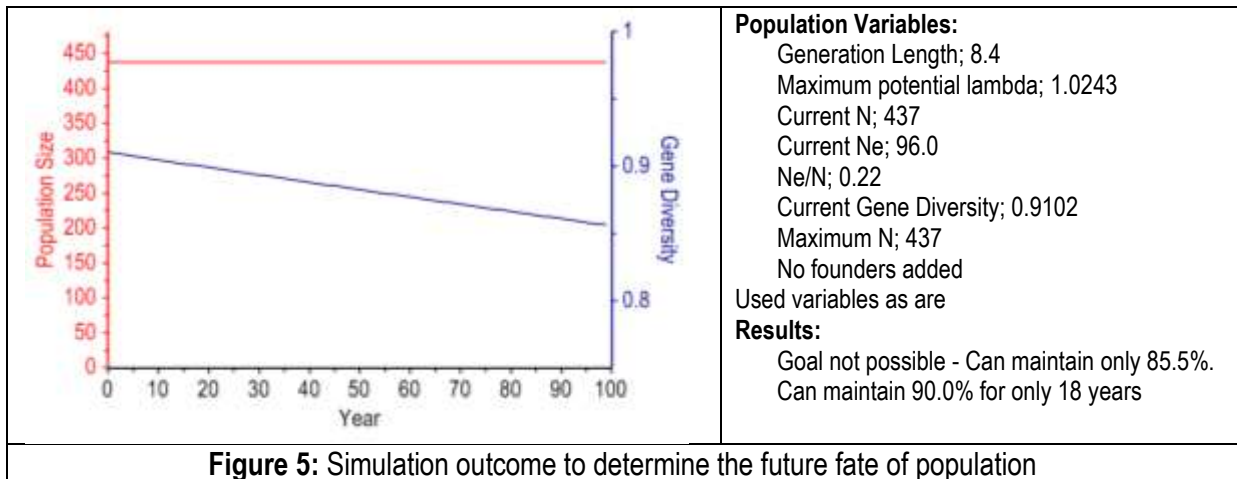

Figure 5: Simulation outcome to determine the future fate of population

The trends observed in the population since its inception indicate that the population has been receiving wild origin individuals by way of rescue and that a significant proportion of these individuals are effective founders. Additionally use of appropriate pairing choices as described in the pairing recommendations can ensure an increase in the current levels of genetic diversity in the population. The inclusion of additional founders with specified periodicity is therefore not proposed for the population; however wild origin animals as may be available on an occasional basis can be used further to complement the genetic diversity of the captive population.

Conclusions and Recommendations

Bengal tigers across their distribution range in the Indian subcontinent are threatened by extensive poaching and habitat destruction leading to its inclusion under Schedule I, Part I of the Wildlife Protection Act, 1972 and as endangered under IUCN Red data list. Tigers are charismatic animals that are a flagship species of the varied habitats they inhabit. Continued threats to tiger populations have necessitated intensive conservation efforts. Management of captive populations to ensure a genetically viable and demographically stable population is a part of these efforts.

The captive population of Bengal tigers (*Panthera tigris tigris*) is characterized by a large population size though a significant proportion of the population carries the recessive allele for white coat colour. Selective breeding of specimens to maximize production of specimens having the white coat colour has led to the increased relatedness in individuals in the captive population as is indicated by the high values of mean inbreeding coefficient (0.2018) and population mean kinship (0.0898) despite the use of a large founder population (40) to achieve the current population size. An additional cause of concern is the presence of 20% specimens of unknown ancestries in the population.

The analysis carried out to develop the breeding recommendations and determining the future fate of the current population lead to the conclusion that the current population is demographically stable and genetically viable.

Management interventions should be focussed on managing the genetic diversity that is present in the population. This can be achieved by using the pairing recommendations suggested to ensure retention of desired levels of genetic diversity in the current population.

The studbook also includes breeding recommendations for tigers having a white coat colour or carrying the gene for white coat colour based on the request of the Central Zoo Authority as these animals have high exhibit value. Pairings for white tiger should however be exclusively based on the pairing recommendations made in this regard as deviations could lead to significant loss of genetic diversity and a further increase in relatedness in the population.

References

Ballou, J.D., Lacy, R.C. and Pollak, J.P. (2011). PMx: software for demographic and genetic analysis and management of pedigreed populations (version 1.2). Chicago Zoological Society, Brookfield, IL, USA. Available from: <http://www.vortex10.org/PMx.html>

Champion, H. G. and Seth, S. K. (1968). A Revised Survey of Forest Types of India, Govt. of India Press, New Delhi, p. 404.

Chundawat, R.S., Khan, J.A. and Mallon, D.P. (2011). *Panthera tigris ssp. tigris*. The IUCN Red List of Threatened Species 2011: e.T136899A4348945. <http://dx.doi.org/10.2305/IUCN.UK.2011-2.RLTS.T136899A4348945.en>

Goodrich, J., Lynam, A., Miquelle, D., Wibisono, H., Kawanishi, K., Pattanavibool, A., Htun, S., Tempa, T., Karki, J., Jhala, Y. and Karanth, U. (2015). *Panthera tigris*. The IUCN Red List of Threatened Species 2015: e.T15955A50659951. <http://dx.doi.org/10.2305/IUCN.UK.20152.RLTS.T15955A50659951.en>

Hiby, L., Lovell, P., Patil, N., Kumar, N.S., Gopaldaswamy, A.M. and Karanth, K.U. (2009). A tiger cannot change its stripes: using a three-dimensional model to match images of living tigers and tiger skins. *Biology letters*, 5: 383–386

ISIS (International Species Information System) (2004). SPARKS 1.54: Single Population Analysis and Records Keeping System. Eagan, MN: International Species Information System. Available from: www.isis.org

Jhala Y. V., Qureshi Q., and Gopal R. (eds) (2015). The status of tigers, copredators & prey in India 2014. National Tiger Conservation Authority, New Delhi & Wildlife Institute of India, Dehradun. TR2015/021

Luo, S.J., Kim, J.H., Johnson, W.E., Van Der Walt, J., Martenson, J., Yuhki, N., Miquelle, D.G., Uphyrkina, O., Goodrich, J.M., Quigley, H., Tilson, R., Brady, G., Martelli, P., Subramaniam, V., McDougal, C., Hean, S., Huang, S.Q., Pan, W., Karanth, U.K., Sunquist, M., Smith, J.L.D. and O'Brien,

- S.J. (2004). Phylogeography and genetic ancestry of tigers (*Panthera tigris*). PLoS Biology 2: 2275-2293.
- Macdonald, D.W. (1983). The ecology of carnivore social behaviour. Nature 301: 379–384. DOI:10.1038/301379a0
- Majumder A, Basu S., Sankar K., Qureshi Q., Jhala Y.V., Nigam P. and Gopal R. (2012). Home ranges of the radio-collared Bengal tigers (*Panthera tigris tigris* L.) in Pench Tiger Reserve, Madhya Pradesh, Central India, Wildl. Biol. Pract., 8(1): 36-49.
- Mazák, V. (1981). *Panthera tigris* Mammalian Species, No. 152, pp. 1-8
- Natesh, N., Atla, G., Nigam, P., Jhala, Y.V., Zachariah, A., Borthakur, U. and Ramakrishnan, U. (2017). Conservation priorities for endangered Indian tigers through a genomic lens. Scientific Reports. 7: 9614 | DOI:10.1038/s41598-017-09748-3
- Nowak, R. M. and Nowak, R. M. (2005). Walker's carnivores of the world. Baltimore: Johns Hopkins University Press.
- Nowell, K. and Jackson, P. (1996). Wild cats: Status survey and conservation action plan. Gland, Switzerland: IUCN-World Conservation Union. 406 p.
- Pocock, R. I. (1917). The Classification of existing Felidae. The Annals and Magazine of Natural History. Series 8, Volume XX: 329–350.
- Schaller, G. B. (1967). The deer and the tiger. A study of wild- life in India. Univ. Chicago Press, Chicago, 370 pp.
- Sunquist, M. (2010). What Is a Tiger? Ecology and Behavior. In Tigers of the world (2nd ed.). Tilson R. and Nyhus P. J. (Eds). Academic Press, London, pp 19-33
- Swain, D. and Behura, B.K. (2013). Melanistic tigers of Similipal Tiger Reserve, India: bane or boon? Tigerpaper: Vol. 40: No. 1, 1-4
- Wozencraft, W. C. (2005). "Order Carnivora". In Wilson, D. E.; Reeder, D. M. Mammal Species of the World (3rd ed.). Johns Hopkins University Press. pp. 545–548. ISBN 978-0-8018-8221-0. OCLC 62265494.
- Xu, X., Dong, G., Schmidt-Küntzel, A., Zhang, X., Zhuang, Y., Fang, R., Sun, X., Hu, X., Zhang, T., Yang, H., Zhang, D., Marker, L., Jiang, Z., Li, R. and Luo, S. (2017). The genetics of tiger pelage color variations. Letter to the Editor. Cell Research:1-4.

Historical Population of Bengal Tigers (*Panthera tigris tigris*) in Indian Zoos

National Stud# House Name LocalID Transponder	Int. Std. #	Sex	Birth Date	Sire	Dam	Location	Date	Event	Old NSB # Remarks
1 MOHAN	1	M	~ 1950	WILD	WILD	INDIA REWA	~ 1950 ~ 1950 19-Dec-69	Capture Transfer Death	W1 White-coat colour
2 BEGUM	2	F	~ 1951	WILD	WILD	INDIA REWA AHMEDABAD	~ 1951 ~ 1951 13-Jun-57 03-Sep-69	Capture Transfer Transfer Death	2 Normal- coat colour
3 RADHA	7	F	10-Apr-55	1	2	REWA DELHI	10-Apr-55 26-Jun-64 02-May-74	Birth Transfer Death	3 White-coat colour
4	6	M	10-Apr-55	1	2	REWA AHMEDABAD	10-Apr-55 13-Mar-57 ~ 1959 ????	Birth Transfer Transfer Death	4 White-coat colour
5 NARBADA	10	F	10-Jul-56	1	2	REWA DELHI	10-Jul-56 14-Apr-57 14-Sep-57	Birth Transfer Death	5 White-coat colour
6 VINDHYA	12	F	10-Jul-56	1	2	REWA DELHI	10-Jul-56 14-Apr-57 30-Aug-74	Birth Transfer Death	6 White-coat colour
7 SULTAN	9	M	10-Jul-56	1	2	REWA AHMEDABAD	10-Jul-56 13-Jun-57 04-Aug-69	Birth Transfer Death	7 White-coat colour
8	13	M	08-May-58	4	2	AHMEDABAD	08-May-58 ????	Birth Death	8 White-coat colour
9	14	F	08-May-58	4	2	AHMEDABAD	08-May-58 ????	Birth Death	9 White-coat colour
10	15	F	08-May-58	4	2	AHMEDABAD	08-May-58 ????	Birth Death	10 White-coat colour
11 RANI	18	F	30-Oct-58	1	3	REWA DELHI	30-Oct-58 26-Jun-63 26-Oct-77	Birth Transfer Death	W 13 White-coat colour
12 RAJA	16	M	30-Oct-58	1	3	REWA DELHI	30-Oct-58 26-Jun-64 19-Aug-77	Birth Transfer Death	W 11 White-coat colour
13 SUKESHI	17	F	30-Oct-58	1	3	REWA DELHI	30-Oct-58 21-Apr-73 02-Feb-75	Birth Transfer Death	W12 White-coat colour
14 CHANDU	521	M	????	WILD	WILD	INDIA ASSAM	~ 1959 05-Feb-59 29-Dec-61	Capture Transfer Transfer Death	14 Normal- coat colour
15 SHIVA	563	M	07-Jun-59	12	3	REWA DELHI JUNAGADH	07-Jun-59 26-Jun-64 21-May-69 11-Sep-78	Birth Transfer Transfer Death	15 White-coat colour
16 MAYA	562	F	07-Jun-59	12	3	REWA DELHI JUNAGADH	07-Jun-59 26-Apr-64 21-May-69 06-Mar-89	Birth Transfer Transfer Death	16 White-coat colour
17 BHOLA	522	M	~ 1946	WILD	WILD	INDIA ASSAM	~ 1959 03-Aug-59 16-Oct-71	Capture Transfer Death	17 Normal- coat colour

National Stud# House Name LocalID Transponder	Int. Std. #	Sex	Birth Date	Sire	Dam	Location	Date	Event	Old NSB # Remarks
18	20	M	28-Sep-59	7	2	AHMEDABAD	28-Sep-59	Birth Itf	18 White-coat colour
19	21	F	28-Sep-59	7	2	AHMEDABAD	28-Sep-59	Birth Itf	W 19 White-coat colour
20	22	F	28-Sep-59	7	2	AHMEDABAD	28-Sep-59	Birth Itf	20 White-coat colour
21		F	28-Sep-59	7	2	AHMEDABAD	28-Sep-59	Birth Itf	White-coat colour
22	24	M	12-Mar-60	7	2	AHMEDABAD	12-Mar-60	Birth Itf	White-coat colour
23	25	F	12-Mar-60	7	2	AHMEDABAD	12-Mar-60	Birth Itf	21 White-coat colour
24	26	F	12-Mar-60	7	2	AHMEDABAD	12-Mar-60	Birth Itf	24 White-coat colour
25 MALINI REWA17	29	F	18-Jun-60	1	3	REWA CALCUTTA	18-Jun-60 25-Aug-63 18-Sep-80	Birth Transfer Death	27 White-coat colour
26 SIKHA 1050	247	F	~ 1957	WILD	WILD	INDIA DEALER CALCUTTA NANDANKAN	~ 1960 26-Aug-60 01-Sep-60 02-Jan-64 18-Nov-74	Capture Transfer Transfer Transfer Death	47 Normal-coat colour
27 HIMADARI	27	M	18-Jun-60	1	3	REWA CALCUTTA	18-Jun-60 09-Aug-63 03-Nov-75	Birth Transfer Death	W 25 White-coat colour
28 NEELADARI	28	M	18-Jun-60	1	3	REWA CALCUTTA	18-Jun-60 09-Aug-63 03-Jun-78	Birth Transfer Death	W 26 White-coat colour
29	31	F	05-Mar-61	7	2	AHMEDABAD	05-Mar-61 25-Oct-66	Birth Death	27 White-coat colour
30	30	M	05-Mar-61	7	2	AHMEDABAD	05-Mar-61 20-Aug-69	Birth Death	29 White-coat colour
31	1275	M	????	UNK	UNK	UNKNOWN NAGPUR TRIVANDRU TRICHUR	???? ???? 26-May-62 22-May-71 06-Apr-81	Birth Transfer Transfer Transfer Death	U 7 Normal-coat colour
32 RAMSINGH 1 BT0001	526	M	~ 1959	WILD	WILD	INDIA HYDERABAD	~ 1963 02-Oct-63 28-Jul-66	Capture Transfer Death	31 Normal-coat colour
33 RANI I BT0002	525	F	30-Jun-57	WILD	WILD	INDIA HYDERABAD	~ 1963 02-Oct-63 27-Jul-77	Capture Transfer Death	32 Normal-coat colour
34 PRADEEP 1049	246	M	~ 1957	WILD	WILD	INDIA BRAHAMCHA NANDANKAN	~ 1964 01-May-64 11-Jan-65 23-Nov-73	Capture Transfer Transfer Death	48 Normal-coat colour
35	42	M	03-May-64	12	11	DELHI	03-May-64 31-Jul-79	Birth Death	W 33 White-coat colour
36 RUKKO	43	M	03-May-64	12	11	DELHI	03-May-64 06-Nov-64	Birth Death	W 34 White-coat colour

National Stud# House Name LocalID Transponder	Int. Std. #	Sex	Birth Date	Sire	Dam	Location	Date	Event	Old NSB # Remarks
37 CHANDA	38	F	~ 1964	WILD	WILD	INDIA TRIVANDRU	~ 1964 02-Jun-64 01-Mar-84	Capture Transfer Death	725 Normal- coat colour
38 RAMESH	44	M	20-Aug-64	1	3	DELHI	20-Aug-64 28-Jan-86	Birth Death	35 White-coat colour
39 RAMU	45	M	20-Aug-64	1	3	DELHI	20-Aug-64 25-May-66	Birth Death	W 36 White-coat colour
40 RATNA	46	F	20-Aug-64	1	3	DELHI	20-Aug-64 15-Jul-83	Birth Death	37 White-coat colour
41 GOVIND 49	47	M	22-Nov-64	1	13	REWA DELHI HYDERABAD	22-Nov-64 20-Apr-66 26-Sep-71 29-Jun-72	Birth Transfer Transfer Death	W 38 White-coat colour
42 RAM	50	M	23-Apr-65	45	6	DELHI TRICHUR TRIVANDRU	23-Apr-65 21-Sep-70 24-Aug-73 12-Sep-83	Birth Transfer Transfer Death	40 White-coat colour
43	52	F	23-Apr-65	45	6	DELHI	23-Apr-65 11-May-65	Birth Death	42 White-coat colour
44 LAXMAN	51	M	23-Apr-65	45	6	DELHI	23-Apr-65 26-Jun-66	Birth Death	W 41 White-coat colour
45 SURAJ	49	M	~ 1962	WILD	WILD	INDIA DELHI SHIMLA DELHI	~ 1965 23-Apr-65 ???? 18-Jan-75 19-Apr-75	Capture Transfer Transfer Transfer Death	39 Normal- coat colour
46 RAVI CAL2	53	M	24-Jul-65	28	25	CALCUTTA	24-Jul-65 29-Jun-84	Birth Death	43 White-coat colour
47 RADHA	1278	F	~ 1965	UNK	UNK	UNKNOWN CIRCUS MYSORE	~ 1965 ~ 1965 ~ 1968 08-Apr-89	Birth Transfer Transfer Death	U 4 Normal- coat colour
48 KRISHNA	248	M	~ 1965	UNK	UNK	UNKNOWN CIRCUS MYSORE	~ 1965 ~ 1965 ~ 1968 03-Sep-84	Birth Transfer Transfer Death	U 5 Normal- coat colour
49 SHOBA	1279	F	~ 1965	UNK	UNK	UNKNOWN TRIVANDRU TRICHUR	~ 1965 09-Mar-71 25-Aug-73 04-Sep-80	Birth Transfer Transfer Death	U 6 Normal- coat colour
50	55	M	11-Jul-65	12	11	DELHI	11-Jul-65 11-Aug-65	Birth Death	W 45 White-coat colour
51	54	F	11-Jul-65	12	11	DELHI	11-Jul-65 12-Aug-65	Birth Death	W 44 White-coat colour
52 CHANDNI CAL1		F	24-Jul-65	28	25	CALCUTTA	24-Jul-65 09-Sep-84	Birth Death	White-coat colour
53 DALIP	57	M	19-Dec-65	12	11	DELHI	19-Dec-65 08-Jul-79	Birth Death	W 49 White-coat colour
54 RAVI	58	M	19-Dec-65	12	11	DELHI	19-Dec-65 17-Apr-67	Birth Death	W 50 White-coat colour

National Stud# House Name LocalID Transponder	Int. Std. #	Sex	Birth Date	Sire	Dam	Location	Date	Event	Old NSB # Remarks
55 RAJKUMARI	59	F	19-Dec-65	12	11	DELHI	19-Dec-65 17-Apr-67	Birth Death	W 51 White-coat colour
56	527	?	????	WILD	WILD	INDIA AHMEDABAD INDIA	~ 1966 03-Jun-66 25-Nov-66	Capture Transfer Death	53 Normal- coat colour
57	528	?	????	WILD	WILD	INDIA AHMEDABAD	~ 1966 03-Sep-66 02-Dec-66	Capture Transfer Death	54 Normal- coat colour
58 GAUTAM REWA26	62	M	26-Mar-66	1	13	REWA DELHI	26-Mar-66 08-Dec-66 16-Aug-71	Birth Transfer Death	W 52 White-coat colour
59	64	M	22-Mar-67	45	6	DELHI	22-Mar-67 23-Mar-67	Birth Death	55 White-coat colour
60	65	F	22-Mar-67	45	6	DELHI SWITZRLND	22-Mar-67 15-Nov-67	Birth lft	White-coat colour
61	66	F	22-Mar-67	45	6	DELHI SWITZRLND	22-Mar-67 15-Dec-67	Birth lft	56 White-coat colour
62 VIMLA	68	F	22-Mar-67	45	6	DELHI JAIPUR	22-Mar-67 29-Mar-74 28-Jun-85	Birth Transfer Death	58 White-coat colour
63 RAM SINGH J RBT0003	530	M	????	WILD	WILD	INDIA HYDERABAD	~ 1967 ~ 1967 22-Oct-80	Capture Transfer Death	59 Normal- coat colour
64 MOTI RBT0004	529	F	????	WILD	WILD	INDIA HYDERABAD	~ 1967 29-Mar-67 22-Nov-69	Capture Transfer Death	60 Normal- coat colour
65 CAL3	69	M	29-Apr-67	28	25	CALCUTTA	29-Apr-67 09-Jun-67	Birth Death	61 White-coat colour
66		F	????	UNK	UNK	UNKNOWN VEERMATA AHMEDABAD	???? ???? 30-Jun-67 25-Feb-78	Birth Transfer Transfer Death	Normal- coat colour
67	77	F	10-Jul-67	12	3	DELHI	10-Jul-67 15-Jul-67	Birth Death	65 White-coat colour
68	78	F	10-Jul-67	12	3	DELHI	10-Jul-67 22-Jul-67	Birth Death	66 White-coat colour
69	76	M	10-Jul-67	12	3	DELHI	10-Jul-67 17-Jan-68	Birth Death	W 64 White-coat colour
70	75	M	10-Jul-67	12	3	DELHI	10-Jul-67 17-Sep-67	Birth Death	W 63 White-coat colour
71		M	10-Jul-67	12	3	DELHI	10-Jul-67 20-Jan-68	Birth Death	White-coat colour
72 DEEPAK 1001	252	M	31-Jul-67	34	26	NANDANKAN	31-Jul-67 10-Feb-86	Birth Death	68 Normal- coat colour
73	81	M	31-Aug-67	12	11	DELHI	31-Aug-67 25-Jan-68	Birth Death	70 White-coat colour
74	80	M	31-Aug-67	12	11	DELHI	31-Aug-67 31-Aug-67	Birth Death	W 69 White-coat colour

National Stud# House Name LocalID Transponder	Int. Std. #	Sex	Birth Date	Sire	Dam	Location	Date	Event	Old NSB # Remarks
75 BHADUR	82	M	31-Aug-67	12	11	DELHI REWA VADODARA	31-Aug-67 05-Apr-68 09-Oct-73 29-Jun-75	Birth Transfer Transfer Death	W 71 White-coat colour
76 ROMA	83	F	31-Aug-67	12	11	DELHI	31-Aug-67 17-Apr-80	Birth Death	W 72 White-coat colour
77 RANI 1002	253	F	~ 1967	WILD	WILD	INDIA NANDANKAN	~ 1967 02-Nov-67 23-Sep-83	Capture Transfer Death	77 Normal- coat colour
78 CHAMELI	84	F	06-Sep-67	1	13	REWA DELHI	06-Sep-67 26-Jul-76 05-Mar-84	Birth Transfer Death	W 74 White-coat colour
79 HOMA	85	F	06-Sep-67	1	13	REWA DELHI	06-Sep-67 06-Apr-68 20-Jan-86	Birth Transfer Death	W 75 White-coat colour
80 CAL5	86	M	08-Sep-67	28	25	CALCUTTA	08-Sep-67 24-Jun-71	Birth Death	W 75 White-coat colour
81 SASHI CAL4	87	F	08-Sep-67	28	25	CALCUTTA	08-Sep-67 ~ Feb 1986	Birth Death	W 76 White-coat colour
82 MOTI	170	M	~ Feb 1968	WILD	WILD	INDIA DELHI INDIA	~ 1968 ~ 1968 13-Feb-86	Capture Transfer Death	117 Normal- coat colour
83 JHAGRU	88	M	03-May-68	12	11	DELHI	03-May-68 05-Apr-75	Birth Death	W 81 White-coat colour
84 RAKESH	89	M	03-May-68	12	11	DELHI LUCKNOW DELHI	03-May-68 ~ Oct 1971 24-Nov-87	Birth Transfer Death	W 82 White-coat colour
85 HARI	90	M	03-May-68	12	11	DELHI	03-May-68 02-Aug-70	Birth Death	W 83 White-coat colour
86 JIM	133	M	06-Mar-67	WILD	WILD	INDIA DELHI	~ 1968 03-Nov-68 18-Jun-79	Capture Transfer Death	84 Normal- coat colour
87 SHERKHAN	95	M	12-Nov-68	45	6	DELHI	12-Nov-68 ????	Birth Death	85 White-coat colour
88 TIPPU	96	M	12-Nov-68	45	6	DELHI LUCKNOW	12-Nov-68 28-Aug-70 ????	Birth Transfer Death	86 White-coat colour
89 ZAIL	97	M	12-Nov-68	45	6	DELHI AHMEDABAD	12-Nov-68 13-Jun-69 18-Apr-82	Birth Transfer Death	87 White-coat colour
90	98	F	12-Nov-68	45	6	DELHI	12-Nov-68 12-Nov-68	Birth Death	88 White-coat colour
91 VITTHAL	1280	M	????	UNK	UNK	UNKNOWN DEALER VADODARA UNKNOWN	???? ???? 13-Jan-69 23-Mar-88	Birth Transfer Transfer Death	U 261 Normal- coat colour
92 RANJIT	524	M	~ 1948	WILD	WILD	INDIA ASSAM INDIA	~ 1969 14-Feb-69 10-Jan-77	Capture Transfer Death	30 Normal- coat colour
93 PHATHIK	531	M	~ 1968	WILD	WILD	INDIA ASSAM	~ 1969 13-Apr-69 03-Feb-78	Capture Transfer Death	89 Normal- coat colour
94 TIPU BT0005	564	M	27-Apr-69	63	33	HYDERABAD	27-Apr-69 24-Jul-89	Birth Death	90 Normal- coat colour

National Stud# House Name LocalID Transponder	Int. Std. #	Sex	Birth Date	Sire	Dam	Location	Date	Event	Old NSB # Remarks
95 RANI JUNIOR BT0006	565	F	27-Apr-69	63	33	HYDERABAD	27-Apr-69 07-Apr-91	Birth Death	91 Normal- coat colour
97 ARUN CAL6	107	M	18-May-69	28	25	CALCUTTA	18-May-69 15-Jun-81	Birth Death	W 78 White-coat colour
98 BARUN CAL7	108	M	18-May-69	28	25	CALCUTTA	18-May-69 22-Apr-88	Birth Death	W 79 White-coat colour
99 KIRANMALA CAL11	110	F	18-May-69	28	25	CALCUTTA	18-May-69 25-Oct-75	Birth Death	W 80 White-coat colour
100	103	M	07-Jun-69	12	3	DELHI	07-Jun-69 10-Jun-69	Birth Death	W 92 White-coat colour
101 ROOP	104	M	07-Jun-69	12	3	DELHI BRISTOL	07-Jun-69 27-Oct-72 05-Mar-84	Birth Transfer Death	W 93 White-coat colour
102	105	F	07-Jun-69	12	3	DELHI	07-Jun-69 10-Jun-69	Birth Death	94 White-coat colour
103 SWARNNA	106	F	07-Jun-69	12	3	DELHI LUCKNOW	07-Jun-69 25-Oct-78 ????	Birth Transfer Death	95 White-coat colour
104 SHAYMALI	532	F	~ 1960	WILD	WILD	INDIA ASSAM	~ 1970 10-Feb-70 10-Jan-74	Capture Transfer Death	96 Normal- coat colour
105 ASHIMA 840008	116	F	11-Apr-70	12	11	DELHI MYSORE	11-Apr-70 05-Feb-85 02-Jul-88	Birth Transfer Death	W 97 White-coat colour
106	117	F	11-Apr-70	12	11	DELHI	11-Apr-70 28-Jan-71	Birth Death	W 98 White-coat colour
107	1281	F	????	UNK	UNK	DELHI TRICHUR	???? 21-Sep-70 25-Dec-72	Birth Transfer Death	U 245 Normal- coat colour
108 RUPA CAL16	123	F	25-Sep-70	28	25	CALCUTTA	25-Sep-70 ~ Feb 1979	Birth Death	W 99 White-coat colour
109 SONA CAL17	124	F	25-Sep-70	28	25	CALCUTTA	25-Sep-70 18-Nov-83	Birth Death	W 100 White-coat colour
110 8	254	F	10-Apr-71	34	26	NANDANKAN	10-Apr-71 15-May-71	Birth Death	101 Normal- coat colour
111 9	255	F	10-Apr-71	34	26	NANDANKAN CIRCUS	10-Apr-71 13-Nov-71	Birth If	102 Normal- coat colour
112 10	256	M	10-Apr-71	34	26	NANDANKAN CIRCUS	10-Apr-71 13-Nov-71	Birth If	103 Normal- coat colour
113 JYOTHI	125	F	09-Jul-71	58	79	DELHI	09-Jul-71 11-Jun-73	Birth Death	W 104 White-coat colour
114	126	M	09-Jul-71	58	79	DELHI	09-Jul-71 12-Jul-71	Birth Death	W 105 White-coat colour
115 GULAB BT0052	127	M	27-Aug-71	12	11	DELHI HYDERABAD	27-Aug-71 14-Apr-73 26-Jul-73	Birth Transfer Death	W 106 White-coat colour

National Stud# House Name LocalID Transponder	Int. Std. #	Sex	Birth Date	Sire	Dam	Location	Date	Event	Old NSB # Remarks
116 NANDINI II 53	128	F	27-Aug-71	12	11	DELHI HYDERABAD	27-Aug-71 14-Apr-73 26-Jul-79	Birth Transfer Death	W 107 White-coat colour
117	129	F	27-Aug-71	12	11	DELHI	27-Aug-71 15-Feb-72	Birth Death	W 108 White-coat colour
118	130	?	27-Aug-71	12	11	DELHI	27-Aug-71 27-Aug-71	Birth Death	W 109 White-coat colour
119	257	F	02-Nov-71	72	77	NANDANKAN	02-Nov-71 18-Dec-71	Birth Death	110 Normal- coat colour
120	131	F	08-Dec-71	45	6	DELHI DEALER	08-Dec-71 05-Feb-73	Birth lft	111 White-coat colour
121	132	F	08-Dec-71	45	6	DELHI DEALER	08-Dec-71 05-Feb-73	Birth lft	112 White-coat colour
122 RAJA BT0007	533	M	~ 1972	WILD	WILD	INDIA HYDERABAD	~ 1972 25-Feb-72 03-Dec-86	Capture Transfer Death	113 Normal- coat colour
123 THARA 12	258	F	02-Apr-72	72	77	NANDANKAN MYSORE	02-Apr-72 04-Dec-72 16-Jun-90	Birth Transfer Death	114 Normal- coat colour
124 13	259	F	02-Apr-72	72	77	NANDANKAN DEALER	02-Apr-72 01-Jun-73	Birth lft	115 Normal- coat colour
125 14	256	M	02-Apr-72	72	77	NANDANKAN DEALER	02-Apr-72 01-Jun-73	Birth lft	103 Normal- coat colour
126	134	M	16-Jun-72	82	40	DELHI	16-Jun-72 30-Jun-72	Birth Death	118 White-coat colour
127	136	F	16-Jun-72	82	40	DELHI	16-Jun-72 18-Jun-72	Birth Death	119 White-coat colour
128 15	261	F	14-Jul-72	34	26	NANDANKAN DEALER	14-Jul-72 19-Feb-74	Birth lft	121 White-coat colour
129 16	262	F	14-Jul-72	34	26	NANDANKAN DEALER	14-Jul-72 19-Feb-74	Birth lft	122 White-coat colour
130 REKHA 1003	263	F	14-Jul-72	34	26	NANDANKAN	14-Jul-72 15-Jun-92	Birth Death	123 White-coat colour
131	135	M	16-Jun-72	82	40	DELHI	16-Jun-72 22-Oct-72	Birth Death	727 White-coat colour
132 MINI	1282	F	03-Sep-72	UNK	37	TRIVANDRU	03-Sep-72 13-Aug-76	Birth Death	U 8 Normal- coat colour
133	1283	M	03-Sep-72	UNK	37	TRIVANDRU	03-Sep-72 16-Aug-73	Birth Death	U 9 Normal- coat colour
134 BHANU 3	268	M	????	UNK	UNK	UNKNOWN RANGOON CALCUTTA	???? ???? 13-Sep-72 23-Dec-88	Birth Transfer Transfer Death	U 246 Normal- coat colour
135 PANDYA	1180	M	~ 1971	WILD	WILD	INDIA VEERMATA	~ 9 Jan 1973 09-Jan-73 07-Aug-91	Capture Transfer Death	Normal- coat colour

National Stud# House Name LocalID Transponder	Int. Std. #	Sex	Birth Date	Sire	Dam	Location	Date	Event	Old NSB # Remarks
136 RANI	1181	F	~ 1971	WILD	WILD	INDIA VEERMATA	~ 9 Jan 1973 09-Jan-73 14-Aug-91	Capture Transfer Death	Normal- coat colour
137 KANCHAN CAL24	74	F	27-Mar-73	28	25	CALCUTTA	27-Mar-73 09-Jul-74	Birth Death	62 White-coat colour
138 SUBASH CAL23	221	M	27-Mar-73	28	25	CALCUTTA ASSAM	27-Mar-73 07-Mar-74 10-May-74	Birth Transfer Death	W 728 White-coat colour
139	143	F	30-May-73	35	79	DELHI	30-May-73 08-Jun-73	Birth Death	W 124 White-coat colour
140	144	F	30-May-73	35	79	DELHI	30-May-73 13-Jun-73	Birth Death	W 125 White-coat colour
141 PARIJAT CAL28	145	M	19-Jun-73	27	52	CALCUTTA	19-Jun-73 02-Feb-74	Birth Death	W 126 White-coat colour
142 CHAMPA CAL25	146	F	19-Jun-73	27	52	CALCUTTA	19-Jun-73 09-Jul-74	Birth Death	W 127 White-coat colour
143 CHAMELI -II CAL26	147	F	19-Jun-73	27	52	CALCUTTA	19-Jun-73 30-Mar-74	Birth Death	W 128 White-coat colour
144 SEPHALI CAL27	147	F	19-Jun-73	27	52	CALCUTTA ASSAM	19-Jun-73 07-Mar-74 15-Oct-91	Birth Transfer Death	W 128 White-coat colour
145 ORIYA/ORMA 18	264	F	22-Jun-73	72	77	NANDANKAN HYDERABAD	22-Jun-73 24-Feb-74 04-Apr-91	Birth Transfer Death	130 Normal- coat colour
146 ROBIN 1004	265	M	22-Jun-73	72	77	NANDANKAN	22-Jun-73 06-Jun-84	Birth Death	131 Normal- coat colour
147 RANI	489	F	~ 1973	WILDG1	WILDG2	INDIA ASSAM	~ Sep 1973 07-Sep-73 28-Feb-82	Capture Transfer Death	132 Normal- coat colour
148 RAJA	484	M	~ 1973	WILDG1	WILDG2	INDIA ASSAM	~ Sep 1973 07-Sep-73 07-Jan-83	Capture Transfer Death	133 Normal- coat colour
149 DISOI/FAUZI	333	F	~ 1969	WILD	WILD	INDIA ASSAM PATNA	~ 1973 06-Nov-73 25-Sep-80 18-May-85	Capture Transfer Transfer Death	134 Normal- coat colour
150	148	M	15-May-74	35	79	DELHI	15-May-74 28-May-74	Birth Death	W 149 White-coat colour
151	149	F	15-May-74	35	79	DELHI	15-May-74 20-May-74	Birth Death	W 135 White-coat colour
152 TOMY	155	M	09-Jul-74	87	40	DELHI PATNA	09-Jul-74 12-Oct-75 05-Mar-90	Birth Transfer Death	137 White-coat colour
153 TIMMI	156	F	09-Jul-74	87	40	DELHI	09-Jul-74 22-Apr-75	Birth Death	138 White-coat colour
154 RAJA	157	M	03-Oct-74	42	37	TRIVANDRU	03-Oct-74 02-Jun-88	Birth Death	U 15 White-coat colour
155 LAKSHMI	158	F	03-Oct-74	42	37	TRIVANDRU	03-Oct-74 26-Dec-84	Birth Death	U 16 White-coat colour

National Stud# House Name LocalID Transponder	Int. Std. #	Sex	Birth Date	Sire	Dam	Location	Date	Event	Old NSB # Remarks
156 MENAKA	159	F	03-Oct-74	42	37	TRIVANDRU	03-Oct-74 24-Sep-82	Birth Death	U 17 White-coat colour
157 RANI/SEETA 348	1288	F	24-Oct-74	48	47	MYSORE BANNERGHA	24-Oct-74 29-Jul-86	Birth Itf	U 20 Normal- coat colour
158 RAJA	1289	M	28-Oct-74	48	47	MYSORE COIMBATOR	28-Oct-74 05-Feb-88 08-Dec-89	Birth Transfer Death	U 19 Normal- coat colour
159 CHANDRAPURI	535	F	~ 1958	WILD	WILD	INDIA ASSAM	~ 1975 03-Feb-75 01-Feb-77	Capture Transfer Death	139 Normal- coat colour
160 SINGRI	536	F	~ 1955	WILD	WILD	INDIA ASSAM	~ 1975 12-Feb-75 05-Sep-76	Capture Transfer Death	140 Normal- coat colour
161 SITA/GEETA	485	F	~ 1974	WILD	WILD	INDIA ASSAM CHATBIR Z DELHI CHATBIR Z	~ 1975 20-Feb-75 03-Nov-78 27-Oct-79 06-Nov-80 21-Jan-90	Capture Transfer Transfer Transfer Death	141 Normal- coat colour
162	537	M	~ Jan 1975	WILD	WILD	INDIA ASSAM	~ 1975 20-Feb-75 01-May-75	Capture Transfer Death	142 Normal- coat colour
163 20	266	F	09-Mar-75	72	77	NANDANKAN	09-Mar-75 17-Sep-75	Birth Death	143 Normal- coat colour
164 GANGA 1005	267	F	09-Mar-75	72	77	NANDANKAN	09-Mar-75 02-Jan-86	Birth Death	144 Normal- coat colour
165 LAKHIMI	538	F	~ Feb 1975	WILD	WILD	INDIA ASSAM	~ 1975 08-Apr-75 21-Nov-76	Capture Transfer Death	145 Normal- coat colour
166	163	M	12-Jun-75	86	105	DELHI	12-Jun-75 12-Jun-75	Birth Death	W 146 White-coat colour
167	164	M	28-Jul-75	27	52	CALCUTTA	28-Jul-75 25-Nov-75	Birth Death	W 147 White-coat colour
168 HIMADRI JR	165	F	28-Jul-75	27	52	CALCUTTA	28-Jul-75 05-Jan-95	Birth Death	W 147 White-coat colour
169 JAMBAVI	1290	F	20-Oct-75	48	47	MYSORE AHMEDABAD	20-Oct-75 19-Dec-81 07-Dec-91	Birth Transfer Death	U 56 Normal- coat colour
170 SATYABHAMA	1291	F	21-Oct-75	48	47	MYSORE	21-Oct-75 11-Dec-94	Birth Death	U 22 Normal- coat colour
171 SHANKAR	495	M	????	WILD	WILD	REWA BHILAI	~ 1976 14-Jan-76 28-Feb-94	Capture Transfer Death	149 Normal- coat colour
172 PAVOI	486	F	~ 1975	WILD	WILD	INDIA ASSAM CIRCUS	~ 1976 30-Mar-76 23-May-98	Capture Transfer Itf	150 Normal- coat colour
173	171	M	20-May-76	82	79	DELHI	20-May-76 20-May-76	Birth Death	151 White-coat colour
174 GEETA/MUKTA	173	F	20-May-76	82	79	DELHI KANPUR	20-May-76 29-Aug-76 16-Jan-81	Birth Transfer Death	152 White-coat colour

National Stud# House Name LocalID Transponder	Int. Std. #	Sex	Birth Date	Sire	Dam	Location	Date	Event	Old NSB # Remarks
175	172	F	20-May-76	82	79	DELHI	20-May-76 21-May-76	Birth Death	153 White-coat colour
176 SARITA	174	F	20-May-76	82	79	DELHI	20-May-76 23-Feb-77	Birth Death	154 White-coat colour
177	175	F	22-May-76	86	40	DELHI	22-May-76 26-Feb-77	Birth Death	155 White-coat colour
178	176	F	22-May-76	86	40	DELHI	22-May-76 03-Feb-77	Birth Death	156 White-coat colour
179 IDUMBI	269	F	05-Jun-76	48	123	MYSORE	05-Jun-76 19-Aug-78	Birth Death	U 26 Normal- coat colour
180 THATIKI	270	F	05-Jun-76	48	123	MYSORE	05-Jun-76 22-Aug-78	Birth Death	U 27 Normal- coat colour
181 SURPNEKA	271	F	05-Jun-76	48	123	MYSORE	05-Jun-76 28-Oct-76	Birth Death	U 28 Normal- coat colour
182 RAJU1	179	M	06-Oct-76	82	76	DELHI	06-Oct-76 09-Feb-77	Birth Death	157 White-coat colour
183	180	F	06-Oct-76	82	76	DELHI	06-Oct-76 06-Oct-76	Birth Death	158 White-coat colour
184 RATTAN	566	M	09-Oct-76	15	16	JUNAGADH	09-Oct-76 22-Sep-83	Birth Death	159 White-coat colour
185 DUFLANG	539	F	~ Jan 1976	WILD	WILD	INDIA ASSAM	~ 1976 23-Nov-76 17-Dec-80	Capture Transfer Death	160 Normal- coat colour
186 BADAL 906	181	M	01-Apr-77	82	79	DELHI KANPUR LUCKNOW	01-Apr-77 28-Aug-79 04-Jan-86 05-Sep-86	Birth Transfer Transfer Death	161 White-coat colour
187 BIJALEE	182	F	01-Apr-77	82	79	DELHI	01-Apr-77 04-Nov-80	Birth Death	162 White-coat colour
188	183	F	01-Apr-77	82	79	DELHI	01-Apr-77 04-Apr-77	Birth Death	163 White-coat colour
189	273	?	05-Apr-77	48	123	MYSORE	05-Apr-77 10-Apr-77	Birth Death	U 29 Normal- coat colour
190 LIPSA 1007	274	F	22-Apr-77	146	130	NANDANKAN	22-Apr-77 11-Feb-91	Birth Death	164 Normal- coat colour
191 23	275	?	22-Apr-77	146	130	NANDANKAN	22-Apr-77 23-Apr-77	Birth Death	165 Normal- coat colour
192 24	276	?	22-Apr-77	146	130	NANDANKAN	22-Apr-77 24-Apr-77	Birth Death	166 Normal- coat colour
193 25	280	M	22-Apr-77	146	130	NANDANKAN	22-Apr-77 17-Aug-77	Birth Death	167 Normal- coat colour
194 SAKTI 50/5	279	F	09-May-77	134	52	CALCUTTA	09-May-77 11-Aug-85	Birth Death	U 247 White-coat colour

National Stud# House Name LocalID Transponder	Int. Std. #	Sex	Birth Date	Sire	Dam	Location	Date	Event	Old NSB # Remarks
195 PURBASA CAL49	278	F	09-May-77	134	52	CALCUTTA	09-May-77 21-Feb-79	Birth Death	U 248 White-coat colour
196 NABARUN CAL48	277	M	09-May-77	134	52	CALCUTTA	09-May-77 20-Apr-79	Birth Death	U 249 White-coat colour
197 ANAND 1008	281	M	22-May-77	72	77	NANDANKAN	22-May-77 17-Sep-92	Birth Death	168 Normal- coat colour
198 RAJU II	184	M	01-Jun-77	82	76	DELHI DACCA	01-Jun-77 ????	Birth lf	169 White-coat colour
199	185	F	01-Jun-77	82	76	DELHI	01-Jun-77 19-Jun-77	Birth Death	170 White-coat colour
200 THIANA BT0035	187	F	06-Jun-77	86	105	DELHI HYDERABAD	06-Jun-77 08-Apr-80 26-May-94	Birth Transfer Death	W 172 White-coat colour
201 DIANA 1006	186	F	06-Jun-77	86	105	DELHI NANDANKAN	06-Jun-77 28-Dec-79 28-Feb-99	Birth Transfer Death	W 173 White-coat colour
202 MUNNA BT0025	190	M	01-Aug-77	94	116	HYDERABAD	01-Aug-77 30-Nov-92	Birth Death	174 White-coat colour
203 ARUN	282	M	01-Aug-77	48	123	MYSORE	01-Aug-77 20-Jan-96	Birth Death	U 30 Normal- coat colour
204 ANITHA	283	F	01-Aug-77	48	123	MYSORE	01-Aug-77 16-Aug-86	Birth Death	U 31 Normal- coat colour
205 ABHILASH	284	F	01-Aug-77	48	123	MYSORE	01-Aug-77 31-Aug-78	Birth Death	U 32 Normal- coat colour
206 ABIYANTHAR	285	F	01-Aug-77	48	123	MYSORE	01-Aug-77 30-Aug-78	Birth Death	U 33 Normal- coat colour
207 SANKAR	487	M	~ Jan 1977	WILD	WILD	INDIA ASSAM	~ 1977 29-Oct-77 07-Sep-85	Capture Transfer Death	175 Normal- coat colour
208	192	F	22-Nov-77	86	105	DELHI	22-Nov-77 22-Nov-77	Birth Death	W 176 White-coat colour
209 GEETA/SEEMA 908	193	F	22-Nov-77	86	105	DELHI KANPUR	22-Nov-77 29-Aug-79 16-Dec-88	Birth Transfer Death	W 177 White-coat colour
210 NEEMA	194	F	22-Nov-77	86	105	DELHI	22-Nov-77 02-Jul-90	Birth Death	W 178 White-coat colour
211	195	M	03-Jan-78	82	79	DELHI	03-Jan-78 04-Jan-78	Birth Death	179 White-coat colour
212	196	F	03-Jan-78	82	79	DELHI	03-Jan-78 04-Jan-78	Birth Death	180 White-coat colour
213	197	F	03-Jan-78	82	79	DELHI	03-Jan-78 09-Jan-78	Birth Death	181 White-coat colour
214 BINA	567	F	28-Jan-78	15	16	JUNAGADH	28-Jan-78 05-Aug-87	Birth Death	184 White-coat colour

National Stud# House Name LocalID Transponder	Int. Std. #	Sex	Birth Date	Sire	Dam	Location	Date	Event	Old NSB # Remarks
215 BALMARANI	491	F	~ 1963	WILD	WILD	INDIA ASSAM PATNA	~ 1978 20-Jan-78 25-Sep-80 ~ 1984	Capture Transfer Transfer If	182 Normal- coat colour
216 CHATAIRANI	540	F	~ 1965	WILD	WILD	INDIA ASSAM	~ 1978 20-Jan-78 02-Jan-89	Capture Transfer Death	183 Normal- coat colour
217 VISHNU	1294	M	18-Mar-78	48	47	MYSORE AHMEDABAD	18-Mar-78 11-Mar-82 11-Oct-95	Birth Transfer Death	U 57 Normal- coat colour
218 RAMU	570	M	16-Apr-78	94	145	HYDERABAD JUNAGADH	16-Apr-78 27-Jan-87 23-Jan-98	Birth Transfer Death	185 Normal- coat colour
219 SITHA	568	F	16-Apr-78	94	145	HYDERABAD	16-Apr-78 28-Feb-00	Birth Death	186 Normal- coat colour
220 SUJATHA BT0011	569	F	16-Apr-78	94	145	HYDERABAD	16-Apr-78 31-May-97	Birth Death	187 Normal- coat colour
221	198	M	07-May-78	82	79	DELHI	07-May-78 10-May-78	Birth Death	188 White-coat colour
222	199	M	07-May-78	82	79	DELHI	07-May-78 16-May-78	Birth Death	189 White-coat colour
223	200	F	07-May-78	82	79	DELHI	07-May-78 07-May-78	Birth Death	190 White-coat colour
224 AMAR	201	M	14-May-78	86	40	DELHI INDORE	14-May-78 31-Oct-82 ????	Birth Transfer Death	191 White-coat colour
225	202	F	14-May-78	86	40	DELHI	14-May-78 17-May-78	Birth Death	192 White-coat colour
226	203	F	14-May-78	86	40	DELHI	14-May-78 20-May-78	Birth Death	193 White-coat colour
227 SONAI RANI	541	F	~ 1968	WILD	WILD	INDIA ASSAM	~ 1978 04-Jul-78 26-Feb-89	Capture Transfer Death	194 Normal- coat colour
228	204	M	09-Oct-78	82	79	DELHI	09-Oct-78 09-Oct-78	Birth Death	195 White-coat colour
229	205	M	09-Oct-78	82	79	DELHI	09-Oct-78 11-Oct-78	Birth Death	196 White-coat colour
230	206	F	09-Oct-78	82	79	DELHI	09-Oct-78 09-Oct-78	Birth Death	197 White-coat colour
231 VIJAY	207	M	05-May-79	86	79	DELHI CHATBIR Z	05-May-79 22-Jun-87	Birth If	W 198 White-coat colour
232 SHORAB	208	M	05-May-79	86	79	DELHI	05-May-79 01-Mar-91	Birth Death	W 199 White-coat colour
233	209	F	05-May-79	86	79	DELHI	05-May-79 05-May-79	Birth Death	W 200 White-coat colour
234 28	287	F	12-May-79	146	130	NANDANKAN	12-May-79 09-Mar-80	Birth Death	201 White-coat colour

National Stud# House Name LocalID Transponder	Int. Std. #	Sex	Birth Date	Sire	Dam	Location	Date	Event	Old NSB # Remarks
235 BASANTHI 29	288	F	12-May-79	146	130	NANDANKAN DELHI	12-May-79 13-Mar-80 17-Mar-96	Birth Transfer Death	202 Normal- coat colour
236 BASANT 30	289	M	12-May-79	146	130	NANDANKAN DELHI ROHTAK	12-May-79 30-Mar-80 23-Sep-92	Birth Transfer Itf	203 Normal- coat colour
237 RUPARANI		F	~ 1967	WILD	WILD	INDIA ASSAM	~ 1979 18-Jun-79 25-Aug-88	Capture Transfer Death	Normal- coat colour
238 MAJBOTIAN	542	M	~ 1963	WILD	WILD	INDIA ASSAM	~ 1979 28-Jun-79 12-Jul-79	Capture Transfer Death	205 Normal- coat colour
239	291	M	22-Jul-79	72	164	NANDANKAN	22-Jul-79 27-Jul-79	Birth Death	206 Normal- coat colour
240	290	F	22-Jul-79	72	164	NANDANKAN	22-Jul-79 23-Jul-79	Birth Death	207 Normal- coat colour
241 SANJAI	543	M	~ 1975	WILD	WILD	INDIA ASSAM	~ 1979 16-Aug-79 16-Aug-87	Capture Transfer Death	208 Normal- coat colour
242 RAMA	1297	M	12-Sep-79	158	157	MYSORE BANNERGHA	12-Sep-79 29-Jul-86 12-Aug-95	Birth Transfer Death	U 20A White-coat colour
243 LAXMAN	1298	M	12-Sep-79	158	157	MYSORE BANNERGHA	12-Sep-79 29-Jul-86 28-Aug-91	Birth Transfer Death	U 20B White-coat colour
244 DEEPA	293	F	20-Oct-79	48	123	MYSORE CIRCUS	20-Oct-79 25-Jun-80	Birth Itf	U 38 White-coat colour
245 PRADEPA	292	F	20-Oct-79	48	123	MYSORE	20-Oct-79 23-Jul-81	Birth Death	U 39 White-coat colour
246 SANDEEPA	294	F	20-Oct-79	48	123	MYSORE CIRCUS	20-Oct-79 25-Jun-80	Birth Itf	U 40 White-coat colour
247 SONA BT0012	544	F	~ 1979	WILD	WILD	INDIA HYDERABAD VISAKAPAT	~ 1979 15-Nov-79 20-Jun-81 15-Jun-00	Capture Transfer Transfer Death	209 Normal- coat colour
248 SHAM BT0018	574	M	15-Nov-79	94	145	HYDERABAD MADRAS	15-Nov-79 08-Jul-90 06-Mar-99	Birth Transfer Death	210 White-coat colour
249 SHYAM BT0019	573	M	15-Nov-79	94	145	HYDERABAD JODHPUR	15-Nov-79 28-Sep-83	Birth Itf	211 White-coat colour
250 RAMU BT0020	571	M	15-Nov-79	94	145	HYDERABAD VISAKAPAT	15-Nov-79 20-Jun-81 21-Apr-99	Birth Transfer Death	212 White-coat colour
251 SONY/Rani BT0021	572	F	15-Nov-79	94	145	HYDERABAD VISAKAPAT	15-Nov-79 20-Jun-81 04-Oct-86	Birth Transfer Death	213 White-coat colour
252 NANDA	1296	F	~ 1979	UNK	UNK	MYSORE AHMEDABAD	~ 1979 19-Dec-81 03-Dec-93	Birth Transfer Death	U 55 White-coat colour
253 ALAKA 1009	296	F	08-Jan-80	72	164	NANDANKAN	08-Jan-80 28-Feb-95	Birth Death	W 214 White-coat colour
254 NANDA 1010	297	F	08-Jan-80	72	164	NANDANKAN	08-Jan-80 01-Aug-91	Birth Death	W 215 White-coat colour

National Stud# House Name LocalID Transponder	Int. Std. #	Sex	Birth Date	Sire	Dam	Location	Date	Event	Old NSB # Remarks
255 DEBABRATA 1011	298	M	08-Jan-80	72	164	NANDANKAN	08-Jan-80 14-Jul-90	Birth Death	W 216 White-coat colour
256 RAJKUMARI	545	F	~ 1976	WILD	WILD	INDIA ASSAM	~ 1980 14-Jun-80 05-May-89	Capture Transfer Death	218 Normal- coat colour
257 RAJKUMAR	490	M	~ Jan 1980	WILD	WILD	INDIA ASSAM	~ 1980 14-Jun-80 05-Apr-93	Capture Transfer Death	217 Normal- coat colour
258 RANI/LAKHI	546	F	~ 1980	WILD	WILD	INDIA ASSAM	~ 1980 23-Jun-80 23-Nov-88	Capture Transfer Death	219 Normal- coat colour
259 TIPPU	1299	M	04-Jul-80	48	47	MYSORE DEALER	04-Jul-80 ????	Birth lft	U 41 Normal- coat colour
260 MUMTAJ	1300	F	04-Jul-80	48	47	MYSORE	04-Jul-80 16-Jul-92	Birth Death	U 42 Normal- coat colour
261 SAFDAR	1301	M	04-Jul-80	48	47	MYSORE	04-Jul-80 ????	Birth Death	U 43 Normal- coat colour
262 GUMNAJ	1302	M	04-Jul-80	48	47	MYSORE	04-Jul-80 ????	Birth Death	U 44 Normal- coat colour
263 RAJU/RAJA	577	M	19-Jul-80	82	161	DELHI CHATBIR Z	19-Jul-80 06-Nov-80 17-Apr-93	Birth Transfer Death	221 Normal- coat colour
264	575	M	19-Jul-80	82	161	DELHI	19-Jul-80 01-Mar-91	Birth Death	222 Normal- coat colour
265 RUPA	576	F	19-Jul-80	82	161	DELHI CHATBIR Z	19-Jul-80 06-Nov-80 ~ 1987	Birth Transfer lft	223 Normal- coat colour
266 AJOY	295	M	????	WILD	WILD	INDIA CALCUTTA	~ 1980 22-Aug-80 05-Dec-91	Capture Transfer Death	220 Normal- coat colour
267 BALRAM	547	M	????	UNK	UNK	MYSORE CHATBIR Z	???? 25-Dec-80 31-May-94	Birth Transfer Death	U 268 Normal- coat colour
268 SANJAY BT0014	494	M	~ 1980	WILDH1	WILDH2	INDIA HYDERABAD SHIMOGA BANNERGHA	~ Dec 1980 01-Jan-81 06-Mar-90 31-Oct-91 02-Oct-99	Capture Transfer Transfer Death	226 Normal- coat colour
269 ARJUN BT0013	492	M	~ 1980	WILDH1	WILDH2	INDIA HYDERABAD	~ 1981 02-Jan-81 21-Jan-95	Capture Transfer Death	225 Normal- coat colour
270 SHEELA BT0015	493	F	~ 1980	WILDH1	WILDH1	INDIA HYDERABAD	~ 1981 02-Jan-81 17-Oct-97	Capture Transfer Death	227 Normal- coat colour
271 MADHU 17	302	M	29-Jan-81	48	123	MYSORE VADODARA	29-Jan-81 24-Sep-82 20-Jan-99	Birth Transfer Death	U 45 Normal- coat colour
272 MANU M00194	304	M	29-Jan-81	48	123	MYSORE	29-Jan-81 17-Mar-00	Birth Death	U 46 Normal- coat colour
273 MANOJ	303	M	29-Jan-81	48	123	MYSORE JAIPUR	29-Jan-81 24-Apr-83 18-Jul-99	Birth Transfer Death	U 47 Normal- coat colour
274 AMAR	305	M	29-Jan-81	203	204	MYSORE PESHWE	29-Jan-81 01-Dec-81 07-Feb-96	Birth Transfer Death	U 48 Normal- coat colour

National Stud# House Name LocalID Transponder	Int. Std. #	Sex	Birth Date	Sire	Dam	Location	Date	Event	Old NSB # Remarks
275 AKBAR	306	M	29-Jan-81	203	204	MYSORE PESHWE	29-Jan-81 01-Dec-81 13-Mar-96	Birth Transfer Death	U 49 Normal- coat colour
276 ANTHONY	307	M	29-Jan-81	203	204	MYSORE PESHWE	29-Jan-81 01-Dec-81 09-Dec-91	Birth Transfer Death	U 50 Normal- coat colour
277	309	F	10-Apr-81	82	79	DELHI	10-Apr-81 10-Apr-81	Birth Death	228 White-coat colour
278 SUNDER	310	M	10-Apr-81	82	79	DELHI	10-Apr-81	Birth ltf	230 White-coat colour
279	308	M	10-Apr-81	82	79	DELHI	10-Apr-81 10-Apr-81	Birth Death	231 White-coat colour
280 SUNDARI 915	311	F	10-Apr-81	82	79	DELHI KANPUR	10-Apr-81 03-Apr-85 25-Oct-88	Birth Transfer Death	W 229 White-coat colour
281 LATA BT0016	578	F	26-Apr-81	94	145	HYDERABAD SHIMOGA	26-Apr-81 06-Mar-90 26-Aug-99	Birth Transfer Death	236 Normal- coat colour
282 HEMA BT0017	579	F	26-Apr-81	94	145	HYDERABAD JUNAGADH	26-Apr-81 26-Jan-87 27-Dec-89	Birth Transfer Death	237 Normal- coat colour
283 39	312	M	29-Apr-81	146	130	NANDANKAN	29-Apr-81 03-May-81	Birth Death	232 Normal- coat colour
284 40	313	M	29-Apr-81	146	130	NANDANKAN	29-Apr-81 11-May-81	Birth Death	233 Normal- coat colour
285 41	314	F	29-Apr-81	146	130	NANDANKAN	29-Apr-81 02-May-81	Birth Death	234 Normal- coat colour
286 42	315	F	29-Apr-81	146	130	NANDANKAN	29-Apr-81 07-May-81	Birth Death	235 Normal- coat colour
287 43	316	F	12-May-81	72	164	NANDANKAN	12-May-81 12-May-81	Birth Death	238 Normal- coat colour
288 44	317	F	12-May-81	72	164	NANDANKAN	12-May-81 13-May-81	Birth Death	239 Normal- coat colour
289 45	318	?	21-May-81	197	190	NANDANKAN	21-May-81 28-May-81	Birth Death	240 Normal- coat colour
290 46	319	?	21-May-81	197	190	NANDANKAN	21-May-81 29-May-81	Birth Death	241 Normal- coat colour
291 47	320	?	21-May-81	197	190	NANDANKAN	21-May-81 31-May-81	Birth Death	242 Normal- coat colour
292 DEEPA BT0022	580	F	21-Jun-81	218	219	HYDERABAD JODHPUR	21-Jun-81 28-Sep-83	Birth ltf	243 White-coat colour
293 ARUN BT0023	581	M	21-Jun-81	218	219	HYDERABAD	21-Jun-81 27-Jan-83	Birth Death	244 White-coat colour
294 PAVAK 1048	322	M	13-Oct-81	197	190	NANDANKAN NAGPUR	13-Oct-81 07-Jan-88 05-Feb-96	Birth Transfer Death	245 Normal- coat colour

National Stud# House Name LocalID Transponder	Int. Std. #	Sex	Birth Date	Sire	Dam	Location	Date	Event	Old NSB # Remarks
295 PRITAM 1013	323	M	13-Oct-81	197	190	NANDANKAN	13-Oct-81 03-May-95	Birth Death	246 Normal- coat colour
296 48	321	M	13-Oct-81	197	190	NANDANKAN	13-Oct-81 24-Aug-82	Birth Death	729 Normal- coat colour
297 BISAKHA 1012	324	F	20-Oct-81	72	201	NANDANKAN	20-Oct-81 05-Jul-01	Birth Death	248 White-coat colour
298 ASWINI 1015	325	M	20-Oct-81	72	201	NANDANKAN	20-Oct-81 12-Aug-89	Birth Death	W 247 White-coat colour
299 ASHOK 53	326	M	27-Oct-81	146	130	NANDANKAN MADRAS	27-Oct-81 15-Oct-85 14-Feb-91	Birth Transfer Death	249 Normal- coat colour
300 ANURADHA 1014	327	F	27-Oct-81	146	130	NANDANKAN	27-Oct-81 11-Apr-98	Birth Death	250 Normal- coat colour
301 BHARAT M6 36		M	20-Nov-81	UNK	UNK	MYSORE VEERMATA BANNERGHA	20-Nov-81 26-Jul-83 21-Feb-99 15-Mar-00	Birth Transfer Transfer Death	Normal- coat colour
302 SUNITA/LATA M7	329	F	21-Nov-81	203	204	MYSORE VEERMATA	21-Nov-81 26-Jul-83 31-Jan-00	Birth Transfer Death	U 51 Normal- coat colour
303 BHARAT	328	M	21-Nov-81	203	204	MYSORE VEERMATA BANNERGHA	21-Nov-81 26-Jul-83 22-Feb-99	Birth Transfer If	U 52 Normal- coat colour
304 SUJATA	330	F	21-Nov-81	203	204	MYSORE JAIPUR	21-Nov-81 24-Apr-83 08-Oct-98	Birth Transfer Death	U 54 Normal- coat colour
305 REJIA	548	F	????	WILD	WILD	INDIA ASSAM	~ 1981 21-Nov-81 07-Mar-82	Capture Transfer Death	251 Normal- coat colour
306 PINAKI 1017	332	M	08-Dec-81	72	164	NANDANKAN	08-Dec-81 27-Sep-99	Birth Death	W 252 Normal- coat colour
307 JAMUNA 1016	331	F	08-Dec-81	72	164	NANDANKAN	08-Dec-81 02-Nov-96	Birth Death	W 253 Normal- coat colour
308 SWAPNA BT0038	583	F	18-Dec-82	94	200	HYDERABAD MADRAS	18-Dec-82 27-Aug-92 21-Jun-00	Birth Transfer Death	254 White-coat colour
309 NARAYANA BT0036	589	M	18-Dec-82	94	200	HYDERABAD	18-Dec-82 09-Feb-02	Birth Death	259 White-coat colour
310 SWARNA BT0037	588	F	18-Dec-82	94	200	HYDERABAD	18-Dec-82 06-Oct-04	Birth Death	260 White-coat colour
311 SUNDARI 19	496	F	~ 1980	WILD	WILD	INDIA CALCUTTA	~ 1982 08-Jan-82 01-Jul-00	Capture Transfer Death	541 Normal- coat colour
312 SASWATHI	1295	F	????	UNK	UNK	MYSORE AHMEDABAD	???? 11-Mar-82 12-Feb-91	Birth Transfer Death	U 58 Normal- coat colour
313	584	F	26-May-82	267	161	CHATBIR Z	26-May-82 28-May-82	Birth Death	U 269 Normal- coat colour
314	585	F	26-May-82	267	161	CHATBIR Z	26-May-82 29-May-82	Birth Death	U 270 Normal- coat colour

National Stud# House Name LocalID Transponder	Int. Std. #	Sex	Birth Date	Sire	Dam	Location	Date	Event	Old NSB # Remarks
315 CHIKU	634	M	~ May 1982	WILD	WILD	INDIA VANVIHAR	~ 1982 ~ Jul 1982 07-May-84	Capture Transfer Death	730 Normal- coat colour
316 RUKIMINI	1302	F	09-Jul-82	UNK	UNK	MYSORE PESHWE	09-Jul-82 24-Oct-84 18-Jun-88	Birth Transfer Death	U 44 Normal- coat colour
317 LAXMI	1305	F	27-Jul-82	UNK	UNK	MYSORE PESHWE	27-Jul-82 24-Oct-84 10-May-99	Birth Transfer Death	U 343 Normal- coat colour
318 GANGA	1303	F	05-Aug-82	48	123	MYSORE PESHWE MYSORE	05-Aug-82 24-Oct-84 06-Jun-97	Birth Transfer Death	U 341 Normal- coat colour
319 SHIVA 15	338	M	05-Aug-82	48	123	MYSORE CALCUTTA	05-Aug-82 04-Apr-83 08-Jan-00	Birth Transfer Death	U 59 Normal- coat colour
320 LEENA/GANGA 16	339	F	05-Aug-82	48	123	MYSORE CALCUTTA	05-Aug-82 04-Apr-83 26-Mar-93	Birth Transfer Death	U 60 Normal- coat colour
321 LATA/PARVATI	340	F	05-Aug-82	48	123	MYSORE VANVIHAR	05-Aug-82 09-Sep-83 10-Jun-90	Birth Transfer Death	U 61 Normal- coat colour
322 LAKSHMI 18	1277	F	????	UNK	UNK	UNKNOWN MYSORE VADODARA	???? ???? 28-Sep-82 06-Oct-93	Birth Transfer Transfer Death	263 Normal- coat colour
323 GEETA	272	F	01-Jan-83	152	215	PATNA RANCHI	01-Jan-83 12-Mar-93 02-Nov-96	Birth Transfer Death	261 White-coat colour
324 JOGESH	590	M	02-Jan-83	267	161	CHATBIR Z LUDHIANA	02-Jan-83 11-Feb-93 18-Aug-00	Birth Transfer Death	U 271 White-coat colour
325 UMESH	591	M	02-Jan-83	267	161	CHATBIR Z LUDHIANA	02-Jan-83 11-Feb-93	Birth Itf	U 273 White-coat colour
326 ROCKY 3	344	F	16-Jun-83	152	149	PATNA RANCHI	16-Jun-83 12-Mar-93 25-Mar-94	Birth Transfer Death	265 White-coat colour
327 MONA	346	M	16-Jun-83	152	149	PATNA	16-Jun-83 22-Mar-91	Birth Death	266 White-coat colour
328 JACKIE	345	F	16-Jun-83	152	149	PATNA	16-Jun-83 26-Dec-96	Birth Death	267 White-coat colour
329 SMITHA	349	F	18-Jun-83	158	157	MYSORE TRICHUR	18-Jun-83 27-May-84 14-Jul-93	Birth Transfer Death	U 65 Normal- coat colour
330 LAXMAN	347	M	18-Jun-83	158	157	MYSORE TRICHUR	18-Jun-83 27-May-84 06-Jan-98	Birth Transfer Death	U 66 Normal- coat colour
331 ROHITAA	348	M	18-Jun-83	158	157	MYSORE TRIVANDRU	18-Jun-83 25-May-84 12-Aug-95	Birth Transfer Death	U 67 Normal- coat colour
332 CHANUKYA	350	M	21-Jun-83	48	123	MYSORE	21-Jun-83	Birth Itf	U 68 Normal- coat colour
333 RAMAYA	351	M	21-Jun-83	48	123	MYSORE	21-Jun-83	Birth Itf	U 69 Normal- coat colour
334 SONIA	352	F	21-Jun-83	48	123	MYSORE TRIVANDRU	21-Jun-83 25-May-84 23-Apr-06	Birth Transfer Death	U 70 Normal- coat colour

National Stud# House Name LocalID Transponder	Int. Std. #	Sex	Birth Date	Sire	Dam	Location	Date	Event	Old NSB # Remarks
335 KARUNA	549	F	????	WILD	WILD	INDIA ASSAM	~ 1983 31-Jul-83 01-Dec-83	Capture Transfer Death	268 Normal- coat colour
336	594	F	22-Aug-83	267	161	CHATBIR Z	22-Aug-83 22-Aug-83	Birth Death	U 274 Normal- coat colour
337	595	M	22-Aug-83	267	161	CHATBIR Z	22-Aug-83 25-Aug-83	Birth Death	U 275 Normal- coat colour
338	593	M	22-Aug-83	267	161	CHATBIR Z	22-Aug-83 26-Aug-83	Birth Death	U 276 Normal- coat colour
339 RAVINDRA 69	599	M	20-Nov-83	250	247	VISAKAPAT HYDERABAD	20-Nov-83 27-Sep-00 29-Apr-01	Birth Transfer Death	272 White-coat colour
340 GAURI	598	F	20-Nov-83	250	247	VISAKAPAT	20-Nov-83	Birth Itf	273 Normal- coat colour
341	597	F	20-Nov-83	250	247	VISAKAPAT	20-Nov-83 23-May-87	Birth Death	274 White-coat colour
342 JANHABI 1020	356	F	11-Dec-83	72	164	NANDANKAN	11-Dec-83 14-Jan-04	Birth Death	275 Normal- coat colour
343 KAVERI 1019	357	F	11-Dec-83	72	164	NANDANKAN SHOLAPUR	11-Dec-83 19-Aug-89 06-Nov-02	Birth Transfer Death	276 Normal- coat colour
344 ROHINI 1018	358	F	11-Dec-83	72	164	NANDANKAN	11-Dec-83 03-Sep-95	Birth Death	277 Normal- coat colour
345 SWETA 1023 190114	362	F	29-Dec-83	255	201	NANDANKAN TEXAS CINCINNAT	29-Dec-83 29-Dec-88 21-May-90 15-Jan-98	Birth Transfer Transfer Death	W 278 White-coat colour
346 SANGRAM 1024	363	M	29-Dec-83	255	201	NANDANKAN	29-Dec-83 06-Feb-97	Birth Death	W 279 White-coat colour
347 SWAPNA 1021	359	F	29-Dec-83	255	201	NANDANKAN JAIPUR	29-Dec-83 10-Jul-88 ~ 2001	Birth Transfer Death	W 280 White-coat colour
348 SIPRA 1022 189158	360	F	29-Dec-83	255	201	NANDANKAN TEXAS CINCINNAT	29-Dec-83 29-Dec-88 18-Oct-89 09-Apr-97	Birth Transfer Transfer Death	W 281 White-coat colour
349 62	361	M	29-Dec-83	255	201	NANDANKAN	29-Dec-83 05-Jan-84	Birth Death	W 282 White-coat colour
350 SIELADEVI	550	F	~ 1964	WILD	WILD	INDIA ASSAM	~ 1984 19-Jan-84 02-Oct-88	Capture Transfer Death	283 Normal- coat colour
351 SHEROO 914	240	M	????	WILD	WILD	UTTARANCH KANPUR	~ 1984 02-Mar-84 08-Apr-89	Capture Transfer Death	284 Normal- coat colour
352 BANANI 65	364	F	08-Mar-84	146	130	NANDANKAN VADODARA	08-Mar-84 29-Apr-88 13-Jan-95	Birth Transfer Death	285 Normal- coat colour
353 SIBAN 66	365	F	08-Mar-84	146	130	NANDANKAN NAGPUR	08-Mar-84 09-Jan-88 26-Aug-97	Birth Transfer Death	286 Normal- coat colour

National Stud# House Name LocalID Transponder	Int. Std. #	Sex	Birth Date	Sire	Dam	Location	Date	Event	Old NSB # Remarks
354 CHANDA 67	366	F	08-Mar-84	146	130	NANDANKAN MADRAS	08-Mar-84 15-Oct-85 22-Nov-92	Birth Transfer Death	287 Normal- coat colour
355 PARVATI 69	371	F	08-May-84	146	164	NANDANKAN BHILAI	08-May-84 12-Mar-85 30-Jun-05	Birth Transfer Death	293 Normal- coat colour
356 68	367	M	08-Mar-84	146	130	NANDANKAN	08-Mar-84 25-Jan-85	Birth Death	731 Normal- coat colour
357 DORA 19		F	08-Mar-84	UNK	UNK	NANDANKAN VADODARA	08-Mar-84 29-Apr-88 13-Jan-95	Birth Transfer Death	Normal- coat colour
358 DORA	370	M	19-Apr-84	48	123	MYSORE AURANGABA	19-Apr-84 06-Sep-84 01-May-86	Birth Transfer Death	U 72 Normal- coat colour
359 MEERA	368	F	19-Apr-84	48	123	MYSORE TRIVANDRU	19-Apr-84 07-Dec-84 10-Jan-88	Birth Transfer Death	U 73 Normal- coat colour
360 HEERA	369	F	19-Apr-84	48	123	MYSORE TRIVANDRU	19-Apr-84 07-Dec-84 14-Feb-89	Birth Transfer Death	U 74 Normal- coat colour
361 JALALO	602	F	02-May-84	267	161	CHATBIR Z	02-May-84 ????	Birth Death	U 278 Normal- coat colour
362 SAROJ	603	F	02-May-84	267	161	CHATBIR Z	02-May-84 28-Mar-94	Birth Death	U 279 Normal- coat colour
363	600	M	02-May-84	267	161	CHATBIR Z	02-May-84 16-May-84	Birth Death	U 280 Normal- coat colour
364	604	M	02-May-84	267	161	CHATBIR Z	02-May-84 02-Aug-84	Birth Death	U 281 Normal- coat colour
365 NEERAJ	601	M	02-May-84	267	161	CHATBIR Z LUDHIANA CHATBIR Z	02-May-84 09-Feb-93 ????	Birth Transfer Death	U 277 Normal- coat colour
366 70	372	M	08-May-84	146	164	NANDANKAN	08-May-84 14-Aug-84	Birth Death	294 Normal- coat colour
367 CHITRA 71	373	M	08-May-84	146	164	NANDANKAN	08-May-84 25-Dec-86	Birth Death	295 Normal- coat colour
368 NEENA	1307	F	09-Jul-84	158	157	MYSORE TRIVANDRU	09-Jul-84 08-Dec-84 07-Nov-00	Birth Transfer Death	U 75 Normal- coat colour
369 MEENA	1308	F	09-Jul-84	158	157	MYSORE COIMBATOR	09-Jul-84 13-Dec-84	Birth Itf	U 76 Normal- coat colour
370 REENA M00187	1309	F	09-Jul-84	158	157	MYSORE	09-Jul-84 22-Jun-00	Birth Death	U 77 Normal- coat colour
371 DARSHAN M00081	375	M	28-Sep-84	203	204	MYSORE	28-Sep-84 28-Aug-96	Birth Death	U 78 Normal- coat colour
372 PRIYADARSHI M00082	374	F	28-Sep-84	203	204	MYSORE	28-Sep-84 28-Mar-95	Birth Death	U 79 Normal- coat colour
373 ABHISEK	379	M	05-Oct-84	266	194	CALCUTTA	05-Oct-84 20-Feb-05	Birth Death	U 250 White-coat colour

National Stud# House Name LocalID Transponder	Int. Std. #	Sex	Birth Date	Sire	Dam	Location	Date	Event	Old NSB # Remarks
374 SOUMIK CAL53	378	M	05-Oct-84	266	194	CALCUTTA	05-Oct-84 24-Feb-90	Birth Death	U 251 White-coat colour
375 CAL52	377	F	05-Oct-84	266	194	CALCUTTA	05-Oct-84 09-Feb-85	Birth Death	U 252 White-coat colour
376 CAL51	376	?	05-Oct-84	266	194	CALCUTTA	05-Oct-84 05-Oct-84	Birth Death	U 253 White-coat colour
377 ATMARAM BT0045	499	M	~ 1981	WILD	WILD	INDIA HYDERABAD	~ 1985 01-Apr-85 03-Dec-92	Capture Transfer Death	299 Normal- coat colour
378 SHANKAR II	498	M	~ 1982	WILD	WILD	ASSAM	~ 1985 19-Apr-85 05-Aug-93	Capture Transfer Death	300 Normal- coat colour
379 KRISHNA 1026	384	M	21-Apr-85	72	164	NANDANKAN SHOLAPUR	21-Apr-85 19-Aug-89 02-Aug-05	Birth Transfer Death	301 Normal- coat colour
380 RADHA I 1025	385	F	21-Apr-85	72	164	NANDANKAN ASSAM	21-Apr-85 20-Mar-89 08-Feb-98	Birth Transfer Death	302 Normal- coat colour
381 BHARAT BT0031	683	M	23-Apr-85	94	220	HYDERABAD	23-Apr-85 24-Aug-97	Birth Death	443 Normal- coat colour
382 LAXSMAN BT0032	684	M	23-Apr-85	94	220	HYDERABAD MADRAS	23-Apr-85 23-Mar-91	Birth lft	444 Normal- coat colour
383 SHOBA	592	F	24-Apr-85	267	161	CHATBIR Z LUDHIANA	24-Apr-85 13-May-90 12-Jun-90	Birth Transfer Death	U 272 Normal- coat colour
384 SALU	608	F	24-Apr-85	267	265	CHATBIR Z LUDHIANA	24-Apr-85 11-Feb-93	Birth lft	U 282 Normal- coat colour
385 SAPALU	609	F	24-Apr-85	267	265	CHATBIR Z	24-Apr-85	Birth lft	U 283 Normal- coat colour
386 BHARATH	610	M	31-May-85	249	292	JODHPUR UDAIPUR	31-May-85 30-Dec-86 24-Aug-97	Birth Transfer Death	305 Normal- coat colour
387 SHERALI	612	M	31-May-85	249	292	JODHPUR JAIPUR UDAIPUR KOTA	31-May-85 15-Feb-88 19-Aug-88 20-Jul-89 14-Oct-95	Birth Transfer Transfer Transfer Death	306 Normal- coat colour
388 PRIYA	611	F	31-May-85	249	292	JODHPUR BIKANER	31-May-85 18-Sep-88 24-May-99	Birth Transfer Death	307 Normal- coat colour
389 AJAY	1310	M	16-Jul-85	158	157	MYSORE	16-Jul-85 10-Jun-86	Birth Death	U 83 Normal- coat colour
390 ABHAY	1311	M	16-Jul-85	158	157	MYSORE	16-Jul-85 20-Dec-85	Birth Death	U 84 Normal- coat colour
391	389	M	15-Aug-85	273	304	JAIPUR	15-Aug-85 15-Aug-85	Birth Death	U 85 Normal- coat colour
392	390	M	15-Aug-85	273	304	JAIPUR	15-Aug-85 16-Aug-85	Birth Death	U 86 Normal- coat colour
393 REENA	1312	F	????	48	47	MYSORE AURANGABA	???? 24-Aug-85 11-Sep-96	Birth Transfer Death	U 87 Normal- coat colour

National Stud# House Name LocalID Transponder	Int. Std. #	Sex	Birth Date	Sire	Dam	Location	Date	Event	Old NSB # Remarks
394 RUHI	1313	F	????	48	47	MYSORE AURANGABA	???? 24-Aug-85	Birth lft	U 88 Normal- coat colour
395 KAIKEI/DEVI 1030	393	F	02-Sep-85	197	190	NANDANKAN PESHWE	02-Sep-85 05-Nov-90 13-Oct-95	Birth Transfer Death	308 Normal- coat colour
396 KAUSALYA 1029	392	F	02-Sep-85	197	190	NANDANKAN	02-Sep-85 19-Apr-94	Birth Death	309 Normal- coat colour
397 SUMITRA 1031	391	F	02-Sep-85	197	190	NANDANKAN	02-Sep-85 29-Oct-91	Birth Death	310 Normal- coat colour
398 SHYAMU	613	M	????	UNK	UNK	HYDERABAD VANVIHAR	???? 18-Sep-85 13-Feb-05	Birth Transfer Death	312 Normal- coat colour
399 JOY 237	242	M	????	WILD	WILD	INDIA DARJEELIN NANDANKAN	~ 1985 01-Oct-85 13-Nov-94 04-Jun-01	Capture Transfer Transfer Death	327 Normal- coat colour
400 SUHELI	506	F	~ 1982	WILD	WILD	INDIA LUCKNOW DELHI	~ 1985 20-Oct-85 22-Sep-88 10-Dec-00	Capture Transfer Transfer Death	311 Normal- coat colour
401 KASHYAP 1028	394	M	26-Oct-85	255	201	NANDANKAN ASSAM	26-Oct-85 24-Mar-89 26-Jun-03	Birth Transfer Death	W 313 White-coat colour
402 KRUTIKA 1027	395	F	26-Oct-85	255	201	NANDANKAN	26-Oct-85 10-Sep-99	Birth Death	W 314 White-coat colour
403 SHIVA BT0026	614	M	01-Nov-85	248	219	HYDERABAD	01-Nov-85 21-Oct-95	Birth Death	315 Normal- coat colour
404 GANGA BT0027	615	M	01-Nov-85	248	219	HYDERABAD	01-Nov-85 29-May-99	Birth Death	316 Normal- coat colour
405 JAMUNA BT0028	616	F	01-Nov-85	248	219	HYDERABAD	01-Nov-85 21-Feb-98	Birth Death	317 Normal- coat colour
406 DHITTOO 916	241	M	~ 1974	WILD	WILD	UTTARANCH LUCKNOW KANPUR	~ 1985 02-Dec-85 18-Dec-85 21-Oct-90	Capture Transfer Transfer Death	318 Normal- coat colour
407	396	M	09-Jan-86	273	304	JAIPUR	09-Jan-86 11-Jan-96	Birth Death	U 93 White-coat colour
408	397	M	09-Jan-86	273	304	JAIPUR	09-Jan-86 15-Jan-86	Birth Death	U 94 White-coat colour
409 RUPAK 8	399	M	01-Feb-86	266	168	CALCUTTA	01-Feb-86 20-Apr-02	Birth Death	319 White-coat colour
410 UDAY 9	398	M	01-Feb-86	266	168	CALCUTTA	01-Feb-86 14-Sep-05	Birth Death	320 White-coat colour
411 KAUSHIK	400	M	01-Feb-86	266	168	CALCUTTA	01-Feb-86 04-Jan-03	Birth Death	321 White-coat colour
412 AJAY	617	M	11-Apr-86	267	265	CHATBIR Z	11-Apr-86 15-Feb-00	Birth Death	U 284 Normal- coat colour

National Stud# House Name LocalID Transponder	Int. Std. #	Sex	Birth Date	Sire	Dam	Location	Date	Event	Old NSB # Remarks
413 SHANKAR	619	M	11-Apr-86	267	265	CHATBIR Z DELHI	11-Apr-86 21-Feb-91 12-Nov-96	Birth Transfer Death	U 285 Normal- coat colour
414 RUKIMINI	618	F	11-Apr-86	267	265	CHATBIR Z DELHI GWALIOR	11-Apr-86 21-Mar-91 09-Jun-92	Birth Transfer Itf	U 286 Normal- coat colour
415 PADMINI	622	F	11-Apr-86	267	265	CHATBIR Z DELHI	11-Apr-86 18-Feb-93 20-Jun-93	Birth Transfer Death	U 287 Normal- coat colour
416 SHEELA	620	F	11-Apr-86	267	265	CHATBIR Z	11-Apr-86 18-Jun-88	Birth Death	U 288 Normal- coat colour
417 82	405	F	08-May-86	298	307	NANDANKAN	08-May-86 08-May-86	Birth Death	W 328 White-coat colour
418 81	404	F	08-May-86	298	307	NANDANKAN	08-May-86 11-May-86	Birth Death	W 329 White-coat colour
419 79	402	M	08-May-86	298	307	NANDANKAN	08-May-86 11-May-86	Birth Death	W 330 White-coat colour
420 80	403	M	08-May-86	298	307	NANDANKAN	08-May-86 12-May-86	Birth Death	W 331 White-coat colour
421 83	406	F	12-May-86	298	254	NANDANKAN	12-May-86 11-Jun-86	Birth Death	W 332 White-coat colour
422 84	407	M	12-May-86	298	254	NANDANKAN	12-May-86 17-May-87	Birth Death	W 333 White-coat colour
423 MAHESH 1032	408	M	12-May-86	298	254	NANDANKAN AHMEDABAD	12-May-86 22-Jan-94 04-May-04	Birth Transfer Death	W 334 White-coat colour
424 DORA-1 86	409	M	18-Jun-86	295	130	NANDANKAN BRAHAMCHA	18-Jun-86 20-Aug-87	Birth Itf	344 Normal- coat colour
425 DORA-II 20	410	M	18-Jun-86	295	130	NANDANKAN VADODARA	18-Jun-86 29-Apr-88 13-Jan-95	Birth Transfer Death	345 Normal- coat colour
426 SRINU	627	M	02-Jul-86	250	247	VISAKAPAT	02-Jul-86 11-Nov-99	Birth Death	338 Normal- coat colour
427	628	F	02-Jul-86	250	247	VISAKAPAT	02-Jul-86 28-Jul-88	Birth Death	339 Normal- coat colour
428	626	F	02-Jul-86	250	247	VISAKAPAT	02-Jul-86 18-May-87	Birth Death	340 Normal- coat colour
429 JAUHAR 917	243	M	10-Aug-86	351	209	KANPUR	10-Aug-86 27-May-97	Birth Death	341 White-coat colour
430 SANJEEV 918	244	M	10-Aug-86	351	209	KANPUR	10-Aug-86 06-Jun-97	Birth Death	342 White-coat colour
431 SHAM/UTTAM 919	245	M	10-Aug-86	351	209	KANPUR CHATBIR Z	10-Aug-86 13-Jan-88	Birth Itf	343 White-coat colour
432 MAYA/MANNAV	413	F	14-Aug-86	273	304	JAIPUR UDAIPUR KOTA	14-Aug-86 18-Aug-86 20-Jul-89 19-Sep-02	Birth Transfer Transfer Death	U 95 Normal- coat colour

National Stud# House Name LocalID Transponder	Int. Std. #	Sex	Birth Date	Sire	Dam	Location	Date	Event	Old NSB # Remarks
433	411	M	14-Aug-86	273	304	JAIPUR	14-Aug-86 18-Aug-86	Birth Death	U 96 Normal- coat colour
434 LAXMI	412	F	14-Aug-86	273	304	JAIPUR UDAIPUR	14-Aug-86 16-Dec-87	Birth lft	U 97 Normal- coat colour
435 DURGA 1034	414	F	31-Aug-86	298	253	NANDANKAN	31-Aug-86 05-Jul-00	Birth Death	W 346 White-coat colour
436 TARINI 1035	416	F	31-Aug-86	298	253	NANDANKAN	31-Aug-86 03-Jun-94	Birth Death	W 347 White-coat colour
437 89	415	F	31-Aug-86	298	253	NANDANKAN	31-Aug-86 18-Mar-87	Birth Death	W 348 White-coat colour
438 JAYANT 920	417	M	10-Sep-86	406	280	KANPUR GWALIOR	10-Sep-86 07-Apr-89	Birth lft	349 White-coat colour
439 JYOTI 921	482	F	10-Sep-86	406	280	KANPUR	10-Sep-86 13-Sep-00	Birth Death	W 350 White-coat colour
440 TINA BT0039	629	F	25-Nov-86	309	308	HYDERABAD	25-Nov-86 13-Dec-06	Birth Death	351 White-coat colour
441 RANA	630	M	25-Nov-86	309	308	HYDERABAD	25-Nov-86 09-Jan-92	Birth Death	352 White-coat colour
442 VISWAMITRA 1037	426	M	29-Nov-86	298	307	NANDANKAN	29-Nov-86 07-Dec-98	Birth Death	W 353 White-coat colour
443 VINITA 1038	425	F	29-Nov-86	298	307	NANDANKAN VANVIHAR	29-Nov-86 06-Nov-88 18-Jun-91	Birth Transfer Death	W 354 White-coat colour
444 VASISTHA 1036	427	M	29-Nov-86	298	307	NANDANKAN	29-Nov-86 23-Mar-90	Birth Death	W 355 White-coat colour
445 94	428	M	29-Nov-86	298	307	NANDANKAN	29-Nov-86 29-Nov-86	Birth Death	W 356 White-coat colour
446 MOTI	505	M	~ 1987	WILD	WILD	INDIA VANVIHAR	~ 1987 03-Jan-87 27-Oct-90	Capture Transfer Death	362 Normal- coat colour
447 TARA	501	F	~ 1987	WILD	WILD	INDIA VANVIHAR SHIVPURI LUCKNOW	~ 1987 03-Jan-87 ???? 24-Jul-98 ~ 2008	Capture Transfer Transfer Transfer Death	363 Normal- coat colour
448 VIKRAM RBT1	551	M	????	WILD	WILD	INDIA ITANAGAR	~ 1987 23-Jan-87 01-Nov-93	Capture Transfer Death	360 Normal- coat colour
449 SHERU	552	M	~ 1986	WILD	WILD	INDIA AURANGABA	~ 1987 26-Feb-87	Capture lft	361 Normal- coat colour
450 SAGAR	503	M	~ 1980	WILD	WILD	INDIA VANVIHAR INDORE	~ 1987 07-May-87 03-Jan-92 21-Jul-98	Capture Transfer Transfer Death	374 Normal- coat colour
451 TILAK 7	432	M	11-Mar-87	266	168	CALCUTTA	11-Mar-87 26-Aug-06	Birth Death	364 White-coat colour

National Stud# House Name LocalID Transponder	Int. Std. #	Sex	Birth Date	Sire	Dam	Location	Date	Event	Old NSB # Remarks
452 CHOTU	1318	M	22-Mar-87	398	321	VANVIHAR	22-Mar-87 26-Jun-07	Birth Death	U 105 White-coat colour
453 MALTI	1319	F	22-Mar-87	398	321	VANVIHAR	22-Mar-87 22-Dec-06	Birth Death	U 106 White-coat colour
454 PETU	500	M	22-Mar-87	398	321	VANVIHAR SHIVPURI NANDANKAN	22-Mar-87 ???? 13-Aug-98 05-Jul-00	Birth Transfer Death	U 104 White-coat colour
455 RAMOO	502	M	~ 1987	WILD	WILD	INDIA LUCKNOW	~ 1987 16-Apr-87 24-Jan-95	Capture Transfer Death	367 Normal- coat colour
456 SONI	637	F	19-Apr-87	327	326	PATNA	19-Apr-87 28-Jun-01	Birth Death	372 White-coat colour
457 SONU	638	M	19-Apr-87	327	326	PATNA	19-Apr-87 19-Nov-97	Birth Death	373 White-coat colour
458 SHANTI 0006B71522	435	F	19-Apr-87	232	210	DELHI	19-Apr-87 10-Jul-01	Birth Death	W 369 White-coat colour
459 RUSTAM	436	M	19-Apr-87	232	210	DELHI VANVIHAR	19-Apr-87 18-Sep-88 21-Jun-04	Birth Transfer Death	W 370 White-coat colour
460	433	F	19-Apr-87	232	210	DELHI	19-Apr-87 20-Apr-87	Birth Death	W 371 White-coat colour
461 REJU 17	438	M	21-May-87	319	320	CALCUTTA	21-May-87 22-Dec-99	Birth Death	U 107 Normal- coat colour
462 BRGUM 18	439	F	21-May-87	319	320	CALCUTTA	21-May-87 18-May-94	Birth Death	U 108 Normal- coat colour
463 95	440	M	28-May-87	295	300	NANDANKAN	28-May-87 28-May-87	Birth Death	375 Normal- coat colour
464 96	441	M	28-May-87	295	300	NANDANKAN	28-May-87 28-May-87	Birth Death	376 Normal- coat colour
465 97	442	F	28-May-87	295	300	NANDANKAN	28-May-87 28-May-87	Birth Death	377 Normal- coat colour
466 RINKI	444	F	26-Jun-87	327	328	PATNA	26-Jun-87 01-Nov-99	Birth Death	W 368 White-coat colour
467 SATYABAN 1039	445	M	25-Jul-87	197	190	NANDANKAN	25-Jul-87 02-Jun-89	Birth Death	378 Normal- coat colour
468 DORA-III 99	446	M	25-Jul-87	197	190	NANDANKAN PRIVATE	25-Jul-87 15-Oct-87	Birth If	379 Normal- coat colour
469 SABITRI 1040	447	F	25-Jul-87	197	190	NANDANKAN VOC PKZOO	25-Jul-87 11-Jul-89	Birth If	380 Normal- coat colour
470 VIJAYA	639	M	10-Aug-87	218	282	JUNAGADH AHMEDABAD	10-Aug-87 24-Feb-89 21-Nov-97	Birth Transfer Death	381 Normal- coat colour
471 SANGITA	642	F	10-Aug-87	218	282	JUNAGADH AHMEDABAD	10-Aug-87 24-Feb-89 16-Jan-06	Birth Transfer Death	382 Normal- coat colour

National Stud# House Name LocalID Transponder	Int. Std. #	Sex	Birth Date	Sire	Dam	Location	Date	Event	Old NSB # Remarks
472	641	F	10-Aug-87	218	282	JUNAGADH	10-Aug-87 18-Jan-88	Birth Death	383 Normal- coat colour
473 DAKSHA	640	F	10-Aug-87	218	282	JUNAGADH	10-Aug-87 11-May-98	Birth Death	384 Normal- coat colour
474 RAJU	657	M	10-Aug-87	218	282	JUNAGADH	10-Aug-87	Birth ltf	414 Normal- coat colour
475 SHYAM 1042	449	M	23-Aug-87	255	201	NANDANKAN	23-Aug-87 06-Jul-00	Birth Death	W 365 White-coat colour
476 SRIYA 1041	448	F	23-Aug-87	255	201	NANDANKAN	23-Aug-87 25-Mar-07	Birth Death	W 366 White-coat colour
477	450	M	25-Sep-87	UNK	UNK	TRIVANDRU	25-Sep-87 25-Sep-87	Birth Death	U 89 Normal- coat colour
478	451	M	25-Sep-87	UNK	UNK	TRIVANDRU	25-Sep-87 25-Sep-87	Birth Death	WU 90 Normal- coat colour
479	452	F	25-Sep-87	UNK	UNK	TRIVANDRU	25-Sep-87 25-Sep-87	Birth Death	U 91 Normal- coat colour
480 DIVYA	1320	F	16-Oct-87	158	170	MYSORE	16-Oct-87 16-Dec-92	Birth Death	U 109 Normal- coat colour
481 BHAVVA	1321	F	16-Oct-87	158	170	MYSORE	16-Oct-87 09-Feb-91	Birth Death	U 110 Normal- coat colour
482 103	453	F	27-Oct-87	346	342	NANDANKAN	27-Oct-87 06-Nov-87	Birth Death	385 White-coat colour
483 104	454	M	27-Oct-87	346	342	NANDANKAN	27-Oct-87 10-Nov-87	Birth Death	386 White-coat colour
484 105	455	M	27-Oct-87	346	342	NANDANKAN	27-Oct-87 18-Nov-87	Birth Death	387 White-coat colour
485 106	456	M	20-Nov-87	295	300	NANDANKAN	20-Nov-87 22-Nov-87	Birth Death	390 Normal- coat colour
486 107	457	F	20-Nov-87	295	297	NANDANKAN	20-Nov-87 22-Nov-87	Birth Death	391 White-coat colour
487 108	458	F	20-Nov-87	295	297	NANDANKAN	20-Nov-87 06-Dec-87	Birth Death	392 White-coat colour
488 MANAS	553	M	????	WILD	WILD	INDIA ASSAM	~ 1987 23-Nov-87 27-Dec-87	Capture Transfer Death	393 Normal- coat colour
489 SANJAY	1182	M	~ 1965	WILD	WILD	INDIA DELHI CHATBIR Z	???? ???? 13-Jan-88	Capture Transfer ltf	Normal- coat colour
490 BALU	459	M	28-Jan-88	331	UNK	TRIVANDRU	28-Jan-88 12-Feb-88	Birth Death	U 111 Normal- coat colour
491 SARAAWATHI	460	F	28-Jan-88	331	UNK	TRIVANDRU	28-Jan-88 12-Feb-88	Birth Death	U 112 Normal- coat colour

National Stud# House Name LocalID Transponder	Int. Std. #	Sex	Birth Date	Sire	Dam	Location	Date	Event	Old NSB # Remarks
492 MALA	461	F	28-Jan-88	331	UNK	TRIVANDRU	28-Jan-88 09-Feb-88	Birth Death	U 242 Normal- coat colour
493 LILY	645	F	06-Feb-88	325	361	CHATBIR Z	06-Feb-88 ????	Birth Death	U 289 Normal- coat colour
494 PUPPY	646	M	06-Feb-88	325	361	CHATBIR Z	06-Feb-88	Birth ltf	U 290 Normal- coat colour
495 VAISHALI	648	F	06-Mar-88	457	328	PATNA	06-Mar-88 17-Mar-97	Birth Death	W 637 White-coat colour
496 RAJKUMAR	554	M	~ 1978	WILD	WILD	INDIA ASSAM SEPAHIJAL	~ 1988 22-Feb-88 15-Feb-89 17-Mar-02	Capture Transfer Transfer Death	396 Normal- coat colour
497	1322	M	23-Mar-88	UNK	UNK	TRICHUR	23-Mar-88 23-Mar-88	Birth Death	U 113 Normal- coat colour
498 RAMA BT0030	651	M	31-Mar-88	248	219	HYDERABAD	31-Mar-88 29-May-97	Birth Death	397 Normal- coat colour
499 GEETHA BT0029	650	F	31-Mar-88	248	219	HYDERABAD MADRAS	31-Mar-88 23-Mar-91 12-Dec-91	Birth Transfer Death	398 Normal- coat colour
500 DINESH 1044	462	M	03-Apr-88	295	300	NANDANKAN	03-Apr-88 11-Apr-88	Birth Death	436 Normal- coat colour
501 PRITAM-II 110	463	M	03-Apr-88	295	300	NANDANKAN	03-Apr-88 06-Jan-89	Birth Death	437 Normal- coat colour
502 SUBRATA 1043	464	M	03-Apr-88	295	300	NANDANKAN	03-Apr-88 21-Mar-02	Birth Death	633 Normal- coat colour
503	467	F	19-Apr-88	273	304	JAIPUR	19-Apr-88 13-May-88	Birth Death	U 114 Normal- coat colour
504 ROHINI	470	F	19-Apr-88	273	304	JAIPUR SEPAHIJAL	19-Apr-88 26-Apr-90 02-May-00	Birth Transfer Death	U 115 Normal- coat colour
505 MOHAN	468	M	19-Apr-88	273	304	JAIPUR	19-Apr-88 14-Nov-96	Birth Death	U 116 Normal- coat colour
506 SOHAN	469	M	19-Apr-88	273	304	JAIPUR JODHPUR	19-Apr-88 20-Jul-90	Birth ltf	U 117 Normal- coat colour
507	555	M	????	WILD	WILD	INDIA VISAKAPAT	~ 1988 27-Apr-88 09-May-88	Capture Transfer Death	399 Normal- coat colour
508	557	M	????	WILD	WILD	INDIA VISAKAPAT	~ 1988 27-Apr-88 13-May-88	Capture Transfer Death	400 Normal- coat colour
509	556	F	????	WILD	WILD	INDIA VISAKAPAT	~ 1988 27-Apr-88 14-May-88	Capture Transfer Death	401 Normal- coat colour
510 RUDRAMUDU BT0046	508	M	~ 1984	WILD	WILD	INDIA HYDERABAD	~ 1988 01-Apr-88 ~ Jun 2006	Capture Transfer Death	424 Normal- coat colour
511 DEBASHIS 1045	472	M	04-May-88	306	297	NANDANKAN	04-May-88 23-Jul-00	Birth Death	403 White-coat colour

National Stud# House Name LocalID Transponder	Int. Std. #	Sex	Birth Date	Sire	Dam	Location	Date	Event	Old NSB # Remarks
512 SUPRIYA 1046	473	F	04-May-88	306	297	NANDANKAN BOKARO	04-May-88 12-Jul-90	Birth lft	404 White-coat colour
513 SUKANTA 1047	471	M	04-May-88	306	297	NANDANKAN	04-May-88 29-Jul-00	Birth Death	W 402 White-coat colour
514 PARAMA 12	475	F	28-May-88	373	168	CALCUTTA	28-May-88	Birth lft	U 254 White-coat colour
515 SWETA 13	474	F	28-May-88	373	168	CALCUTTA	28-May-88	Birth lft	U 255 White-coat colour
516 922	654	F	05-Jun-88	406	280	KANPUR	05-Jun-88 05-Jun-88	Birth Death	407 White-coat colour
517 KURU 923	483	F	05-Jun-88	406	280	KANPUR	05-Jun-88 27-Jan-95	Birth Death	408 White-coat colour
518 BHASKAR	478	M	11-Jun-88	UNK	UNK	TRIVANDRU	11-Jun-88 15-Feb-89	Birth Death	U 118 Normal- coat colour
519 SANKAR	479	M	11-Jun-88	UNK	UNK	TRIVANDRU	11-Jun-88 14-Nov-89	Birth Death	U 119 Normal- coat colour
520 ASWATHI	477	F	11-Jun-88	UNK	UNK	TRIVANDRU	11-Jun-88 25-May-89	Birth Death	U 120 Normal- coat colour
521 RAJ 924	480	M	13-Jun-88	406	280	KANPUR	13-Jun-88 03-Nov-89	Birth Death	409 White-coat colour
522 KISHORE 925	481	M	13-Jun-88	406	280	KANPUR GWALIOR	13-Jun-88 07-Apr-89	Birth lft	410 White-coat colour
523 MANU	1323	M	01-Jul-88	UNK	UNK	TRIVANDRU	01-Jul-88 05-Jul-88	Birth Death	U 121 Normal- coat colour
524 MOHAN	1324	M	01-Jul-88	UNK	UNK	TRIVANDRU	01-Jul-88 30-Jul-88	Birth Death	U 122 Normal- coat colour
525 HARI	1325	M	01-Jul-88	UNK	UNK	TRIVANDRU	01-Jul-88 03-Feb-91	Birth Death	U 123 Normal- coat colour
526 RANI RBT2	497	F	~ 1983	WILD	WILD	INDIA ITANAGAR	~ 1988 19-Jul-88 11-Oct-03	Capture Transfer Death	412 Normal- coat colour
527 116	653	F	04-Aug-88	346	342	NANDANKAN	04-Aug-88 08-Aug-88	Birth Death	405 White-coat colour
528 115	652	F	04-Aug-88	346	342	NANDANKAN	04-Aug-88 06-Aug-88	Birth Death	406 White-coat colour
529 MOHINI	507	F	~ Feb 1988	WILD	WILD	INDIA VANVIHAR	~ 1988 16-Aug-88 14-Dec-96	Capture Transfer Death	413 Normal- coat colour
530 ROHIT/UDAY 12	656	M	21-Aug-88	218	282	JUNAGADH RAJKOT	21-Aug-88 21-Aug-92 30-Dec-08	Birth Transfer Death	415 Normal- coat colour
531 PADMA 13	658	F	21-Aug-88	218	282	JUNAGADH RAJKOT	21-Aug-88 21-Jan-92 05-Aug-95	Birth Transfer Death	416 Normal- coat colour

National Stud# House Name LocalID Transponder	Int. Std. #	Sex	Birth Date	Sire	Dam	Location	Date	Event	Old NSB # Remarks
532	659	F	27-Aug-88	250	247	VISAKAPAT	27-Aug-88 18-May-89	Birth Death	417 Normal-coat colour
533	662	F	27-Aug-88	250	247	VISAKAPAT	27-Aug-88 03-Dec-88	Birth Death	418 Normal-coat colour
534	660	M	27-Aug-88	250	247	VISAKAPAT	27-Aug-88 23-May-89	Birth Death	419 Normal-coat colour
535 MEENA	661	F	27-Aug-88	250	247	VISAKAPAT	27-Aug-88	Birth Itf	420 Normal-coat colour
536	1326	F	25-Sep-88	UNK	UNK	TRICHUR	25-Sep-88 01-Mar-89	Birth Death	U 124 Normal-coat colour
537	1327	F	25-Sep-88	UNK	UNK	TRICHUR	25-Sep-88 25-Feb-89	Birth Death	U 125 Normal-coat colour
538 RAJA	1328	M	25-Sep-88	UNK	UNK	TRICHUR TRIVANDRU	25-Sep-88 19-Jul-91 26-Mar-06	Birth Transfer Death	U 126 Normal-coat colour
539 118	661	M	01-Oct-88	197	254	NANDANKAN	01-Oct-88 27-Oct-88	Birth Death	420 White-coat colour
540 117	664	M	01-Oct-88	197	254	NANDANKAN	01-Oct-88 19-Dec-88	Birth Death	W 422 White-coat colour
541 120	643	F	09-Nov-88	298	253	NANDANKAN	09-Nov-88 09-Nov-88	Birth Death	W 388 White-coat colour
542 119	644	M	09-Nov-88	298	253	NANDANKAN	09-Nov-88 29-Nov-88	Birth Death	W 389 White-coat colour
543 MONU	667	M	12-Nov-88	327	326	PATNA RANCHI	12-Nov-88 01-Mar-93 12-Nov-94	Birth Transfer Death	425 White-coat colour
544 121	670	M	20-Nov-88	298	307	NANDANKAN	20-Nov-88 21-Nov-88	Birth Death	W 426 White-coat colour
545 122	668	M	20-Nov-88	298	307	NANDANKAN	20-Nov-88 22-Nov-88	Birth Death	W 427 White-coat colour
546 123	669	F	20-Nov-88	298	307	NANDANKAN	20-Nov-88 21-Nov-88	Birth Death	W 428 White-coat colour
547 124	671	F	20-Nov-88	298	307	NANDANKAN	20-Nov-88 23-Nov-88	Birth Death	W 429 White-coat colour
548 BISWARUP 1051	637	M	29-Nov-88	346	344	NANDANKAN BOKARO	29-Nov-88 12-Jul-90 ~ 1995	Birth Transfer Death	372 White-coat colour
549 126	638	F	29-Nov-88	346	344	NANDANKAN	29-Nov-88 19-Dec-88	Birth Death	373 White-coat colour
550 SASWATI 1052	639	F	29-Nov-88	346	344	NANDANKAN	29-Nov-88 01-Sep-89	Birth Death	381 White-coat colour
551 128	674	F	16-Dec-88	346	342	NANDANKAN	16-Dec-88 21-Dec-88	Birth Death	430 White-coat colour

National Stud# House Name LocalID Transponder	Int. Std. #	Sex	Birth Date	Sire	Dam	Location	Date	Event	Old NSB # Remarks
552 129	672	F	16-Dec-88	346	342	NANDANKAN	16-Dec-88 22-Dec-88	Birth Death	431 White-coat colour
553 130	673	F	16-Dec-88	346	342	NANDANKAN	16-Dec-88 25-Dec-88	Birth Death	432 White-coat colour
554 MANASI	509	F	~ 1989	WILD	WILD	INDIA ASSAM	~ 1989 19-Jan-89 28-Jul-99	Capture Transfer Death	433 Normal- coat colour
555 MITHILA	649	F	06-Mar-89	457	328	PATNA RANCHI	06-Mar-89 21-Jan-94 19-Sep-96	Birth Transfer Death	W 434 White-coat colour
556 SURESH 1054	686	M	06-Mar-89	298	253	NANDANKAN PESHWE PUNE	06-Mar-89 05-Nov-90 ???? 18-Aug-09	Birth Transfer Transfer Death	W 445 White-coat colour
557 SUGYANI 1053	687	F	06-Mar-89	298	253	NANDANKAN	06-Mar-89 27-Feb-90	Birth Death	W 446 White-coat colour
558 MANJIT 142	699	M	28-Mar-89	298	307	NANDANKAN	28-Mar-89 19-Feb-90	Birth Death	W 457 White-coat colour
559 MANDAKINI 1061	701	F	28-Mar-89	298	307	NANDANKAN	28-Mar-89 08-Jul-89	Birth Death	W 458 White-coat colour
560 SAUDAMINI 1062	700	F	28-Mar-89	298	307	NANDANKAN	28-Mar-89 14-Oct-89	Birth Death	W 459 White-coat colour
561 DINESH 1060		M	28-Mar-89	298	307	NANDANKAN	28-Mar-89 14-Jan-91	Birth Death	White-coat colour
562 PUSHPA		F	06-Apr-89	325	383	CHATBIR Z	06-Apr-89 09-Feb-93	Birth Death	Normal- coat colour
563 LADDI	719	M	06-Apr-89	263	383	CHATBIR Z	06-Apr-89 12-Apr-93	Birth Death	U 291 Normal- coat colour
564 TONY	720	M	06-Apr-89	263	383	CHATBIR Z	06-Apr-89 ~ 1989	Birth Death	U 292 Normal- coat colour
565 RINKU/SURAJ	722	M	06-Apr-89	263	383	CHATBIR Z DELHI	06-Apr-89 18-Mar-93 20-Jun-93	Birth Transfer Death	U 293 Normal- coat colour
566 MERRY	721	F	06-Apr-89	263	383	CHATBIR Z LUCKNOW	06-Apr-89 04-Apr-95 26-Dec-97	Birth Transfer Death	U 294 Normal- coat colour
567 KARUNA BT0040	682	F	11-Apr-89	202	308	HYDERABAD	11-Apr-89 09-Oct-11	Birth Death	442 White-coat colour
568 MOINAK 14	685	M	03-May-89	373	168	CALCUTTA	03-May-89 15-Nov-96	Birth Death	WU 256 White-coat colour
569 MONALI	688	F	12-May-89	294	353	NAGPUR	12-May-89 30-Aug-98	Birth Death	447 Normal- coat colour
570 SONALI	689	F	12-May-89	294	353	NAGPUR	12-May-89 27-Nov-95	Birth Death	448 Normal- coat colour
571 133	694	M	01-Jun-89	346	342	NANDANKAN	01-Jun-89 03-Jun-89	Birth Death	451 White-coat colour

National Stud# House Name LocalID Transponder	Int. Std. #	Sex	Birth Date	Sire	Dam	Location	Date	Event	Old NSB # Remarks
572 134	692	M	01-Jun-89	346	342	NANDANKAN	01-Jun-89 21-Sep-89	Birth Death	452 White-coat colour
573 DEVI 135	693	F	01-Jun-89	346	342	NANDANKAN	01-Jun-89 16-May-06	Birth Death	453 White-coat colour
574 137	697	F	02-Jun-89	197	254	NANDANKAN	02-Jun-89 20-Aug-89	Birth Death	W 454 Normal- coat colour
575 RAMESH 136	696	M	02-Jun-89	197	254	NANDANKAN	02-Jun-89 23-Sep-89	Birth Death	W 455 Normal- coat colour
576 KIRAN	1333	F	16-Aug-89	387	432	UDAIPUR	16-Aug-89 ????	Birth Death	U 134 Normal- coat colour
577 SURAJ	1334	M	16-Aug-89	387	432	UDAIPUR BIKANER	16-Aug-89 24-Apr-91	Birth Itf	U 135 Normal- coat colour
578	1335	M	16-Aug-89	387	432	KOTA	16-Aug-89 18-Aug-89	Birth Death	U 367 Normal- coat colour
579 RAJA	702	M	26-Oct-89	448	526	ITANAGAR	26-Oct-89	Birth Itf	460 Normal- coat colour
580 MIRA	703	F	26-Oct-89	448	526	ITANAGAR	26-Oct-89 28-Aug-90	Birth Death	461 Normal- coat colour
582 NEENA RBT-5	704	F	26-Oct-89	448	526	ITANAGAR	26-Oct-89 13-Sep-90	Birth Death	462 Normal- coat colour
583 MEENA RBT-4		F	26-Oct-89	448	526	ITANAGAR	26-Oct-89 28-Aug-90	Birth Death	Normal- coat colour
584 CHANDA	1375	M	02-Nov-89	387	432	KOTA JODHPUR	02-Nov-89 18-Jun-00	Birth Itf	U 370 Normal- coat colour
585 CHANDNI	1376	F	02-Nov-89	387	432	KOTA	02-Nov-89 09-Jul-09	Birth Death	U 371 Normal- coat colour
586	1336	F	28-Nov-89	371	372	MYSORE	28-Nov-89 ????	Birth Death	U 1331 Normal- coat colour
587	1337	F	28-Nov-89	371	372	MYSORE	28-Nov-89 ????	Birth Death	U 132 Normal- coat colour
588	1338	F	28-Nov-89	371	372	MYSORE	28-Nov-89 ????	Birth Death	WU 133 Normal- coat colour
589 SAURAV 1063	706	M	22-Dec-89	306	297	NANDANKAN	22-Dec-89 22-Dec-89	Birth Death	463 White-coat colour
590 MADHABI 1065	705	F	22-Dec-89	306	297	NANDANKAN	22-Dec-89 24-Dec-89	Birth Death	464 White-coat colour
591 KUNTI 1064	707	F	22-Dec-89	306	297	NANDANKAN	22-Dec-89 22-Dec-89	Birth Death	465 White-coat colour
592 SURAJ	1339	M	22-Dec-89	387	432	KOTA	22-Dec-89 03-Sep-00	Birth Death	U 368 Normal- coat colour

National Stud# House Name LocalID Transponder	Int. Std. #	Sex	Birth Date	Sire	Dam	Location	Date	Event	Old NSB # Remarks
593 KIRAN	1340	F	22-Dec-89	387	432	KOTA	22-Dec-89 04-Aug-00	Birth Death	U 369 Normal- coat colour
594 RITA 20	510	F	????	WILD	WILD	INDIA CALCUTTA	~ 1990 17-Jan-90 13-Sep-94	Capture Transfer Death	466 Normal- coat colour
595 BHADRA M00190	1341	F	20-Jan-90	242	157	BANNERGHA MYSORE	20-Jan-90 10-Jul-96 01-May-05	Birth Transfer Death	U 365 Normal- coat colour
596 KUSHA	1342	M	23-Jan-90	243	UNK	BANNERGHA SHIMOGA	23-Jan-90 23-Jan-90 05-Jul-94	Birth Transfer Death	U 136 Normal- coat colour
597 LAVA	1343	M	23-Jan-90	243	UNK	BANNERGHA BELLARY	23-Jan-90 18-Oct-93	Birth Itf	U 437 Normal- coat colour
598 THUNGA	1344	F	23-Jan-90	243	UNK	BANNERGHA BELLARY MYSORE	23-Jan-90 ???? 19-Oct-93 04-Mar-95	Birth Transfer Transfer Death	U 138 Normal- coat colour
599 BHADNA	1345	F	23-Jan-90	243	UNK	BANNERGHA	23-Jan-90	Birth Itf	U 139 Normal- coat colour
600	1348	M	28-Feb-90	UNK	UNK	TRICHUR	28-Feb-90 02-Mar-90	Birth Death	U 142 Normal- coat colour
601	1349	M	28-Feb-90	UNK	UNK	TRICHUR	28-Feb-90 17-Sep-94	Birth Death	U 143 Normal- coat colour
602 RANI	1350	F	28-Feb-90	UNK	UNK	TRICHUR TRIVANDRU	28-Feb-90 19-Jul-91 08-Dec-09	Birth Transfer Death	U 144 Normal- coat colour
603 MOHINI	512	F	~ 1990	WILD	WILD	INDIA PATNA	~ 1990 08-Mar-90 22-Nov-97	Capture Transfer Death	512 Normal- coat colour
604 MYNA BT0047	511	F	~ 1979	WILD	WILD	INDIA HYDERABAD	~ 1990 19-Mar-90 04-Feb-98	Capture Transfer Death	467 Normal- coat colour
605 MAHESH BT0041	709	M	03-Apr-90	202	310	HYDERABAD JUNAGADH	03-Apr-90 02-Mar-01	Birth Itf	468 White-coat colour
606 MURUGAN BT0042	708	M	03-Apr-90	202	310	HYDERABAD	03-Apr-90 16-Jul-98	Birth Death	W469 White-coat colour
607 MINI 1067	710	F	08-Apr-90	295	300	NANDANKAN TATA	08-Apr-90 17-Feb-94 21-Jul-95	Birth Transfer Death	470 Normal- coat colour
608 JAYA/VIJAYA 000-6B71-CEB M00075	712	F	08-Apr-90	295	300	NANDANKAN MYSORE	08-Apr-90 10-Oct-93 31-Mar-10	Birth Transfer Death	471 Normal- coat colour
609 KADAMBINI 1068	711	F	08-Apr-90	295	300	NANDANKAN	08-Apr-90 26-Apr-95	Birth Death	472 Normal- coat colour
610	715	M	10-Apr-90	378	380	ASSAM	10-Apr-90 12-Apr-90	Birth Death	473 Normal- coat colour
611	714	M	10-Apr-90	378	380	ASSAM	10-Apr-90 13-Apr-90	Birth Death	474 Normal- coat colour
612	713	F	10-Apr-90	378	380	ASSAM	10-Apr-90 23-Apr-90	Birth Death	475 Normal- coat colour

National Stud# House Name LocalID Transponder	Int. Std. #	Sex	Birth Date	Sire	Dam	Location	Date	Event	Old NSB # Remarks
613 GAYATRI 1071	718	F	24-Apr-90	255	201	NANDANKAN CALCUTTA	24-Apr-90 10-Aug-91 01-Mar-02	Birth Transfer Death	W 476 White-coat colour
614 GAURAB 1069	717	M	24-Apr-90	255	201	NANDANKAN	24-Apr-90 21-Jun-02	Birth Death	W 477 White-coat colour
615 URMILA 1070	716	F	24-Apr-90	255	201	NANDANKAN MADRAS	24-Apr-90 09-Oct-93 21-Jun-94	Birth Transfer Death	W 478 White-coat colour
616 RAHUL	681	M	13-May-90	263	384	CHATBIR Z LUDHIANA	13-May-90 09-Feb-93	Birth Itf	U 295 Normal- coat colour
617 VIKRAM	680	M	13-May-90	263	384	CHATBIR Z LUCKNOW	13-May-90 09-Feb-93 31-Jan-96	Birth Transfer Death	U 296 Normal- coat colour
618 RAMMAN	678	F	13-May-90	263	384	CHATBIR Z LUDHIANA	13-May-90 09-Feb-93	Birth Itf	U 297 Normal- coat colour
619 PUSHPA	679	F	13-May-90	263	384	CHATBIR Z LUDHIANA	13-May-90 09-Feb-93	Birth Itf	U 298 Normal- coat colour
620 SHYAM/SURAJ	1351	M	13-May-90	263	383	CHATBIR Z DELHI	13-May-90 18-Mar-93 13-Nov-00	Birth Transfer Death	U 364 Normal- coat colour
621	635	F	~ May 1990	WILD	WILD	UTTARANCH KANPUR	09-Jun-90 10-Jun-90 24-Jun-90	Capture Transfer Death	736 Normal- coat colour
622 SHANKAR 1073	724	M	11-Jun-90	197	402	NANDANKAN	11-Jun-90 27-Sep-99	Birth Death	W 483 White-coat colour
623 SUMAN 1074	725	M	11-Jun-90	197	402	NANDANKAN BANNERGHA	11-Jun-90 07-Sep-01 18-May-04	Birth Transfer Death	W 484 White-coat colour
624 RAKESH 1072	723	M	11-Jun-90	197	402	NANDANKAN	11-Jun-90 24-Oct-03	Birth Death	W 485 White-coat colour
625 RAJENDRA 1076	728	M	15-Jun-90	197	254	NANDANKAN HYDERABAD	15-Jun-90 22-Sep-00	Birth Transfer	W 486 Normal- coat colour
626 JAWAHAR 1077	726	M	15-Jun-90	197	254	NANDANKAN	15-Jun-90 24-May-05	Birth Death	W 487 Normal- coat colour
627 PREM 1075	727	M	15-Jun-90	197	254	NANDANKAN	15-Jun-90 16-Jun-90	Birth Death	W 488 Normal- coat colour
628 158	730	M	14-Jul-90	442	397	NANDANKAN	14-Jul-90 28-Jul-90	Birth Death	489 White-coat colour
629 159	729	F	14-Jul-90	442	397	NANDANKAN	14-Jul-90 14-Jul-90	Birth Death	490 White-coat colour
630 160	731	F	14-Jul-90	442	397	NANDANKAN	14-Jul-90 17-Jul-90	Birth Death	491 White-coat colour
631	732	F	23-Jul-90	250	247	VISAKAPAT	23-Jul-90 04-Nov-91	Birth Death	492 Normal- coat colour
632	734	F	23-Jul-90	250	247	VISAKAPAT	23-Jul-90 23-Jul-90	Birth Death	493 Normal- coat colour

National Stud# House Name LocalID Transponder	Int. Std. #	Sex	Birth Date	Sire	Dam	Location	Date	Event	Old NSB # Remarks
633 GAUTAM	733	M	23-Jul-90	250	247	VISAKAPAT	23-Jul-90 20-Jun-93	Birth Death	494 Normal- coat colour
634 MANAS 161	735	F	10-Aug-90	197	190	NANDANKAN	10-Aug-90 23-Aug-90	Birth Death	495 Normal- coat colour
635 MANASI 167	738	M	10-Aug-90	197	190	NANDANKAN	10-Aug-90 25-Feb-93	Birth Death	W 498 Normal- coat colour
636 ARJUN 162 M00186	736	M	10-Aug-90	197	190	NANDANKAN MYSORE	10-Aug-90 10-Oct-93 07-Mar-97	Birth Transfer Death	497 Normal- coat colour
638 MANINI 164	904	F	10-Aug-90	197	190	NANDANKAN	10-Aug-90 18-Oct-96	Birth Death	737 Normal- coat colour
639 RAMA 165	739	M	26-Aug-90	306	297	NANDANKAN	26-Aug-90	Birth Itf	499 White-coat colour
640 RINI 166	738	F	27-Aug-90	306	297	NANDANKAN VANVIHAR	27-Aug-90 27-Feb-95 05-Sep-08	Birth Transfer Death	W 498 White-coat colour
641 BIKKY	740	M	22-Oct-90	263	361	CHATBIR Z LUDHIANA	22-Oct-90 12-Apr-94	Birth Itf	U 299 Normal- coat colour
642 RUBBY	741	M	22-Oct-90	263	361	CHATBIR Z	22-Oct-90 22-Oct-90	Birth Death	U 300 Normal- coat colour
643 RANI	742	F	22-Oct-90	263	361	CHATBIR Z	22-Oct-90 23-Oct-90	Birth Death	U 301 Normal- coat colour
644 SUNNY	675	M	12-Dec-90	UNK	395	PESHWE VEERMATA	12-Dec-90 27-Oct-94 21-Jan-05	Birth Transfer Death	503 Normal- coat colour
645 CHETAK	676	M	12-Dec-90	UNK	395	PESHWE	12-Dec-90	Birth Itf	504 Normal- coat colour
646 LEGEND	677	F	12-Dec-90	UNK	395	PESHWE	12-Dec-90	Birth Itf	505 Normal- coat colour
647 RAKTA	514	M	????	WILD	WILD	INDIA PATNA RANCHI	~ 1990 01-Dec-90 21-Jan-94 28-Nov-96	Capture Transfer Transfer Death	638 Normal- coat colour
648	1355	F	28-Dec-90	371	372	MYSORE	28-Dec-90 30-Dec-90	Birth Death	WU 150 Normal- coat colour
649 RAJKUMARI I	559	F	~ 1989	WILD	WILD	INDIA ASSAM	~ 1991 03-Jan-91 30-May-92	Capture Transfer Death	506 Normal- coat colour
650 GANESH	743	M	24-Jan-91	171	355	BHILAI	24-Jan-91 31-Jul-08	Birth Death	642 Normal- coat colour
651 LAXMI	744	F	24-Jan-91	171	355	BHILAI	24-Jan-91 20-Nov-01	Birth Death	643 Normal- coat colour
652	746	M	09-Mar-91	378	380	ASSAM	09-Mar-91 23-Apr-91	Birth Death	507 Normal- coat colour
653	745	F	09-Mar-91	378	380	ASSAM	09-Mar-91 13-Mar-91	Birth Death	508 Normal- coat colour

National Stud# House Name LocalID Transponder	Int. Std. #	Sex	Birth Date	Sire	Dam	Location	Date	Event	Old NSB # Remarks
654	747	F	09-Mar-91	378	380	ASSAM	09-Mar-91 13-Apr-91	Birth Death	509 Normal- coat colour
655	1356	M	10-Mar-91	273	304	JAIPUR	10-Mar-91 14-Mar-91	Birth Death	U 151 Normal- coat colour
656 SHERU	1357	M	10-Mar-91	273	304	JAIPUR	10-Mar-91 23-Dec-03	Birth Death	U 152 Normal- coat colour
657 RESHMA	1358	F	10-Mar-91	273	304	JAIPUR	10-Mar-91	Birth Itf	WU 153 Normal- coat colour
658 MAYA DEVI	515	F	????	WILD	WILD	INDIA INDORE	~ 1991 01-Apr-91	Capture Itf	510 Normal- coat colour
659 CHANDU	748	M	06-Apr-91	294	353	NAGPUR	06-Apr-91	Birth Itf	511 Normal- coat colour
660 170	750	F	10-Apr-91	423	436	NANDANKAN	10-Apr-91 10-Apr-91	Birth Death	W 513 White-coat colour
661 171	751	F	10-Apr-91	423	436	NANDANKAN	10-Apr-91 11-Apr-91	Birth Death	W 514 White-coat colour
662 172	749	F	10-Apr-91	423	436	NANDANKAN	10-Apr-91 19-Apr-91	Birth Death	W 515 White-coat colour
663 GORA	1359	M	21-Apr-91	386	432	UDAIPUR	21-Apr-91	Birth Itf	U 154 Normal- coat colour
664 BADAL	1360	M	22-Apr-91	386	432	UDAIPUR	22-Apr-91	Birth Itf	U 155 Normal- coat colour
665 SHAVITRI	1361	F	21-Apr-91	386	432	UDAIPUR	21-Apr-91 07-Jul-91	Birth Death	U 156 Normal- coat colour
666 14	691	M	18-May-91	218	473	JUNAGADH	18-May-91 19-May-91	Birth Death	449 Normal- coat colour
667 15	690	F	18-May-91	218	473	JUNAGADH	18-May-91 19-May-91	Birth Death	450 Normal- coat colour
668 AMAN	754	M	18-May-91	278	458	DELHI	18-May-91 14-Aug-96	Birth Death	516 White-coat colour
669 SWARAJ	755	M	18-May-91	278	458	DELHI	18-May-91	Birth Itf	W 517 White-coat colour
670 SHRUTHI	905	F	30-Jun-91	WILD	WILD	INDIA MADRAS	30-Jun-91 15-Sep-96 25-Jun-98	Capture Transfer Death	738 Normal- coat colour
671	1362	F	03-Jul-91	371	372	MYSORE	03-Jul-91 30-Apr-94	Birth Death	WU 157 Normal- coat colour
672	1363	F	03-Jul-91	371	372	MYSORE	03-Jul-91 12-Jul-91	Birth Death	WU 158 Normal- coat colour
673	1364	F	03-Jul-91	371	372	MYSORE	03-Jul-91 31-Mar-92	Birth Death	WU 159 Normal- coat colour

National Stud# House Name LocalID Transponder	Int. Std. #	Sex	Birth Date	Sire	Dam	Location	Date	Event	Old NSB # Remarks
674	1365	F	03-Jul-91	371	372	MYSORE	03-Jul-91 30-Apr-94	Birth Death	WU 160 Normal-coat colour
675 SHYAMAL	756	M	30-Jul-91	401	554	ASSAM	30-Jul-91 28-Dec-06	Birth Death	518 White-coat colour
676 SHYAMALI	757	F	30-Jul-91	401	554	ASSAM	30-Jul-91 08-May-02	Birth Death	519 White-coat colour
677 SHRUTHI	1367	F	04-Aug-91	243	777	BANNERGHA	04-Aug-91	Birth ltf	U211 Normal-coat colour
678 SNEHA	1368	F	04-Aug-91	243	777	BANNERGHA	04-Aug-91 ~ 2016	Birth Death	U 212 Normal-coat colour
679 SUNITHA	1369	F	04-Aug-91	243	777	BANNERGHA BELLARY	04-Aug-91 18-Oct-93	Birth ltf	U 213 Normal-coat colour
680 MALESHANKAR	758	M	13-Aug-91	268	281	SHIMOGA	13-Aug-91	Birth ltf	520 Normal-coat colour
681 SHARAVATHI 9.81098E+12	759	F	13-Aug-91	268	281	SHIMOGA MANGALORE	13-Aug-91 25-Nov-03 03-May-13	Birth Transfer Death	521 Normal-coat colour
682 LAXMIKANTA 174	763	M	14-Aug-91	197	402	NANDANKAN MADRAS	14-Aug-91 04-Apr-98 28-Jan-02	Birth Transfer Death	523 White-coat colour
683 AJAY 173		M	14-Aug-91	197	402	NANDANKAN INDONESIA	14-Aug-91 31-Jan-93	Birth ltf	White-coat colour
684 PRAMOD 175	762	M	14-Aug-91	197	402	NANDANKAN AURANGABA	14-Aug-91 10-Apr-95 02-Jul-04	Birth Transfer Death	W 524 White-coat colour
685 SHIVANI 10008		F	21-Aug-91	454	447	VANVIHAR	21-Aug-91 21-Jan-12	Birth Death	Normal-coat colour
686 MITA 22	1371	F	05-Sep-91	319	320	CALCUTTA	05-Sep-91 17-Jul-97	Birth Death	U 164 Normal-coat colour
687 BOB 23	1372	M	05-Sep-91	319	320	CALCUTTA	05-Sep-91 15-Aug-05	Birth Death	U 165 Normal-coat colour
688 176	764	F	07-Sep-91	346	342	NANDANKAN	07-Sep-91 12-Sep-91	Birth Death	525 White-coat colour
689 177	765	F	07-Sep-91	346	342	NANDANKAN	07-Sep-91 15-Sep-91	Birth Death	526 White-coat colour
690 178	766	F	07-Sep-91	346	342	NANDANKAN	07-Sep-91 25-Sep-91	Birth Death	739 White-coat colour
691 MUKTA	1373	F	12-Sep-91	276	317	PESHWE PUNE	12-Sep-91 12-Sep-91 08-Mar-11	Birth Transfer Death	WU 344 Normal-coat colour
692 SHANTI	1374	F	26-Oct-91	UNK	UNK	CHATBIR Z UNKNOWN	26-Oct-91 28-May-08	Birth ltf	Normal-coat colour
693 SITA	771	F	26-Oct-91	UNK	361	CHATBIR Z LUDHIANA	26-Oct-91 27-Jan-95	Birth ltf	U 302 Normal-coat colour
694 BAGGA	772	M	26-Oct-91	UNK	361	CHATBIR Z LUDHIANA	26-Oct-91 29-Jun-94	Birth ltf	U 303 Normal-coat colour

National Stud# House Name LocalID Transponder	Int. Std. #	Sex	Birth Date	Sire	Dam	Location	Date	Event	Old NSB # Remarks
695 MINO	773	F	26-Oct-91	UNK	361	CHATBIR Z	26-Oct-91 21-Aug-10	Birth Death	U 304 Normal- coat colour
696 179	767	F	31-Oct-91	295	300	NANDANKAN	31-Oct-91 05-Nov-91	Birth Death	528 Normal- coat colour
697 180	768	F	31-Oct-91	295	300	NANDANKAN	31-Oct-91 05-Nov-91	Birth Death	529 Normal- coat colour
698 CHANDNI	770	F	08-Oct-91	457	328	PATNA RANCHI	08-Oct-91 21-Jan-94 29-Oct-01	Birth Transfer Death	530 White-coat colour
699 BIJLEE	769	F	08-Oct-91	457	328	PATNA	08-Oct-91 01-Mar-96	Birth Death	531 White-coat colour
700 SAGAR 181	777	M	20-Nov-91	511	307	NANDANKAN	20-Nov-91 05-Jul-00	Birth Death	535 White-coat colour
701 SANGAM 182	774	M	20-Nov-91	511	307	NANDANKAN TATA	20-Nov-91 16-Feb-94 11-Aug-97	Birth Transfer Death	536 White-coat colour
702 SAROJ 183	776	M	20-Nov-91	511	307	NANDANKAN	20-Nov-91 17-Feb-96	Birth Death	537 White-coat colour
703 SAGAR 184	775	F	20-Nov-91	511	307	NANDANKAN	20-Nov-91 02-Mar-92	Birth Death	W 538 White-coat colour
704 SUHAS 5	1377	M	28-Nov-91	242	157	BANNERGHA	28-Nov-91	Birth Itf	U 168 Normal- coat colour
705 NEETHU 6	1378	F	28-Nov-91	242	157	BANNERGHA	28-Nov-91 18-Oct-99	Birth Death	U 169 Normal- coat colour
706 MEGHA	1379	F	28-Nov-91	242	157	BANNERGHA	28-Nov-91	Birth Itf	U 170 Normal- coat colour
707 KRISHNA BT0034 0006B74601	778	M	11-Dec-91	381	220	HYDERABAD VISAKAPAT	11-Dec-91 21-Aug-00	Birth Itf	539 Normal- coat colour
708 VASU BT0033	779	M	11-Dec-91	381	220	HYDERABAD	11-Dec-91 20-Aug-93	Birth Death	540 Normal- coat colour
709 TARA	782	F	12-Jan-92	448	526	ITANAGAR	12-Jan-92 18-Mar-96	Birth Death	542 Normal- coat colour
710 ROBY	781	M	12-Jan-92	448	526	ITANAGAR	12-Jan-92 21-Dec-01	Birth Death	543 Normal- coat colour
711 RUBY	780	F	12-Jan-92	448	526	ITANAGAR	12-Jan-92 13-Oct-98	Birth Death	544 Normal- coat colour
715 192	800	M	14-Feb-92	346	342	NANDANKAN	14-Feb-92 17-Apr-92	Birth Death	560 White-coat colour
716 193	798	M	14-Feb-92	346	342	NANDANKAN	14-Feb-92 21-Apr-92	Birth Death	561 White-coat colour
717 194	799	M	14-Feb-92	346	342	NANDANKAN	14-Feb-92 30-Apr-92	Birth Death	562 White-coat colour

National Stud# House Name LocalID Transponder	Int. Std. #	Sex	Birth Date	Sire	Dam	Location	Date	Event	Old NSB # Remarks
718 195	797	M	14-Feb-92	346	342	NANDANKAN	14-Feb-92 17-Apr-92	Birth Death	563 White-coat colour
719 RAMANA BT0044 0006B71426 M00073	783	M	21-Feb-92	202	310	HYDERABAD MYSORE	21-Feb-92 04-Mar-95 23-Mar-09	Birth Transfer Death	545 White-coat colour
720 SUGUNA BT0043	784	F	21-Feb-92	202	310	HYDERABAD	21-Feb-92 12-Mar-93	Birth Death	546 White-coat colour
721 MALLIKA BT0049	561	F	~ 1992	WILD	WILD	INDIA HYDERABAD	~ 1992 16-Mar-92 28-Dec-93	Capture Transfer Death	547 Normal- coat colour
722 KHANNA BT0051	785	M	01-Apr-92	202	308	HYDERABAD	01-Apr-92 26-Mar-96	Birth Death	548 White-coat colour
723 HENA BT0050	786	F	01-Apr-92	202	308	HYDERABAD	01-Apr-92 03-Jun-99	Birth Death	549 White-coat colour
724 17	787	M	06-Apr-92	218	473	JUNAGADH	06-Apr-92 28-Apr-92	Birth Death	550 Normal- coat colour
725 18	789	F	06-Apr-92	218	473	JUNAGADH	06-Apr-92 29-Apr-92	Birth Death	551 Normal- coat colour
726 DIVYA 19	788	F	06-Apr-92	218	473	JUNAGADH	06-Apr-92 01-Dec-98	Birth Death	552 Normal- coat colour
727 NURUL/MUKUL 185	792	M	08-Apr-92	442	344	NANDANKAN	08-Apr-92 22-Jan-93	Birth Death	553 White-coat colour
728 186	790	F	08-Apr-92	442	344	NANDANKAN	08-Apr-92 09-Apr-92	Birth Death	554 White-coat colour
729 LAXMIPRIYA 187	791	F	08-Apr-92	442	344	NANDANKAN	08-Apr-92 06-Jul-99	Birth Death	555 White-coat colour
730 RADHA II 188 6832100	796	F	09-Apr-92	306	297	NANDANKAN RAJKOT	09-Apr-92 22-Feb-95 30-Dec-09	Birth Transfer Death	556 White-coat colour
731 TAPAN 189	794	M	09-Apr-92	306	297	NANDANKAN PATNA	09-Apr-92 06-Mar-01 26-Mar-05	Birth Transfer Death	W 557 White-coat colour
732 MALATI 190	795	F	09-Apr-92	306	297	NANDANKAN INDONESIA	09-Apr-92 31-Jan-93	Birth Itf	W 558 White-coat colour
733 BHANUPRIYA 191	793	F	09-Apr-92	306	297	NANDANKAN AURANGABA	09-Apr-92 07-Apr-95 21-Nov-12	Birth Transfer Death	W 559 White-coat colour
734 GABBAR	801	M	03-May-92	425	352	VADODARA	03-May-92	Birth Itf	564 Normal- coat colour
735 FULAN	802	F	03-May-92	425	352	VADODARA	03-May-92 08-Dec-98	Birth Death	565 Normal- coat colour
736	1380	F	03-May-92	UNK	UNK	TRICHUR	03-May-92 30-Jan-98	Birth Death	U 171 Normal- coat colour

National Stud# House Name LocalID Transponder	Int. Std. #	Sex	Birth Date	Sire	Dam	Location	Date	Event	Old NSB # Remarks
737	1381	M	03-May-92	UNK	UNK	TRICHUR	03-May-92 06-Jan-98	Birth Death	U 172 Normal- coat colour
738 SOHAN	1382	M	19-May-92	577	388	BIKANER	19-May-92	Birth ltf	U 173 Normal- coat colour
739 RUKMA	1383	F	19-May-92	577	388	BIKANER	19-May-92	Birth ltf	U 174 Normal- coat colour
740 CHANDA	1384	F	19-May-92	577	388	BIKANER	19-May-92	Birth ltf	U 175 Normal- coat colour
741	1385	F	19-May-92	577	388	BIKANER	19-May-92	Birth ltf	U 372 Normal- coat colour
742 RAJ	803	M	09-Jun-92	278	458	DELHI	09-Jun-92 19-Feb-95	Birth Death	567 White-coat colour
743 BASANTI	906	F	09-Jun-92	278	458	DELHI	09-Jun-92 17-Mar-96	Birth Death	740 White-coat colour
744 KIKO	804	F	09-Jun-92	278	458	DELHI VANVIHAR	09-Jun-92 21-Nov-05 30-Jun-08	Birth Transfer Death	W 568 White-coat colour
745 MAIKO	907	M	09-Jun-92	278	458	DELHI	09-Jun-92 05-Jan-94	Birth Death	W 741 White-coat colour
746 JAVED	805	M	09-Jul-92	457	328	PATNA	09-Jul-92 19-Nov-99	Birth Death	569 White-coat colour
747 CHANDANI	806	F	09-Jul-92	457	328	PATNA RANCHI	09-Jul-92 21-Jan-94 29-Oct-01	Birth Transfer Death	570 White-coat colour
748	808	?	28-Jul-92	250	247	VISAKAPAT	28-Jul-92 01-Aug-92	Birth Death	571 Normal- coat colour
749	810	?	28-Jul-92	250	247	VISAKAPAT	28-Jul-92 28-Jul-92	Birth Death	572 Normal- coat colour
750	809	?	28-Jul-92	250	247	VISAKAPAT	28-Jul-92 ????	Birth Death	573 Normal- coat colour
751	811	?	28-Jul-92	250	247	VISAKAPAT	28-Jul-92 ????	Birth Death	574 Normal- coat colour
752 ANUPAMA 196	812	F	31-Jul-92	295	297	NANDANKAN AHMEDABAD	31-Jul-92 05-Apr-98 02-Apr-06	Birth Transfer Death	575 White-coat colour
753 197	813	F	31-Jul-92	295	297	NANDANKAN	31-Jul-92 02-Oct-92	Birth Death	576 White-coat colour
754 198	814	F	31-Jul-92	295	297	NANDANKAN	31-Jul-92 04-Aug-92	Birth Death	577 White-coat colour
755 SARASWATI	807	F	26-Jul-92	171	355	BHILAI	26-Jul-92 24-May-12	Birth Death	578 Normal- coat colour
756 RAKHI	1386	F	13-Aug-92	273	304	JAIPUR	13-Aug-92 13-Nov-92	Birth Death	U 176 Normal- coat colour

National Stud# House Name LocalID Transponder	Int. Std. #	Sex	Birth Date	Sire	Dam	Location	Date	Event	Old NSB # Remarks
757 ROHIT 98102055368	816	M	21-Aug-92	346	342	NANDANKAN	21-Aug-92 03-Aug-09	Birth Death	579 White-coat colour
758 200	817	F	21-Aug-92	346	342	NANDANKAN	21-Aug-92 15-Apr-94	Birth Death	580 White-coat colour
759 RINKY 201	818	F	21-Aug-92	346	342	NANDANKAN	21-Aug-92 10-Apr-14	Birth Death	581 White-coat colour
760 ARUN 202	848	M	29-Aug-92	475	436	NANDANKAN	29-Aug-92 05-Jul-00	Birth Death	W 609 White-coat colour White-coat colour
761 TARUN 203	845	M	29-Aug-92	475	436	NANDANKAN BHILAI	29-Aug-92 12-Jan-96 11-Jun-05	Birth Transfer Death	W 610 White-coat colour
762 205	846	F	29-Aug-92	475	436	NANDANKAN	29-Aug-92 02-Sep-92	Birth Death	W 611 White-coat colour
763 204	847	F	29-Aug-92	475	436	NANDANKAN	29-Aug-92 29-Aug-92	Birth Death	W 612 White-coat colour
764 RAMOO	519	M	30-Aug-92	450	658	INDORE DELHI	30-Aug-92 17-Aug-99 27-May-13	Birth Transfer Death	582 Normal- coat colour
765 SHYAMOO 006B81316	520	M	30-Aug-92	450	658	INDORE	30-Aug-92	Birth Itf	583 Normal- coat colour
766 SULTAN	819	M	17-Sep-92	398	529	VANVIHAR	17-Sep-92 07-Jan-02	Birth Death	584 Normal- coat colour
767 SHYAMLI 0006B74B7C	820	F	17-Sep-92	398	529	VANVIHAR BILASPUR TATA	17-Sep-92 10-Nov-95 14-Mar-96 17-Feb-11	Birth Transfer Transfer Death	585 Normal- coat colour
768 BIRAWALI	822	F	19-Sep-92	548	512	BOKARO	19-Sep-92 23-Dec-98	Birth Death	587 White-coat colour
769 BIRJU	821	M	19-Sep-92	548	512	BOKARO	19-Sep-92	Birth Itf	W 586 White-coat colour
770 BALI	908	M	19-Sep-92	548	512	BOKARO	19-Sep-92 19-Mar-93	Birth Death	W 742 White-coat colour
771 SULTAN 000-6435-26E	1387	M	05-Oct-92	274	395	PESHWE PUNE	05-Oct-92 ???? 13-Nov-09	Birth Transfer Death	U 345 Normal- coat colour
772 SUPRIYA	1388	F	05-Oct-92	274	395	PESHWE VEERMATA	05-Oct-92 27-Oct-94 26-Dec-05	Birth Transfer Death	U 346 Normal- coat colour
773	1389	F	05-Oct-92	274	395	PESHWE	05-Oct-92 23-Jun-94	Birth Death	U 347 Normal- coat colour
774	824	F	16-Nov-92	250	247	VISAKAPAT	16-Nov-92	Birth Itf	588 Normal- coat colour
775 209	825	F	09-Dec-92	513	435	NANDANKAN	09-Dec-92 31-Oct-93	Birth Death	W 589 White-coat colour

National Stud# House Name LocalID Transponder	Int. Std. #	Sex	Birth Date	Sire	Dam	Location	Date	Event	Old NSB # Remarks
776 TAPSI 210	826	F	09-Dec-92	513	435	NANDANKAN BHILAI	09-Dec-92 12-Jan-96	Birth Itf	W 590 White-coat colour
777 POOJA I	1366	F	????	UNK	UNK	UNKNOWN BANNERGHA	???? ???? 12-Feb-93	Birth Transfer Death	U 210 Normal- coat colour
778	827	M	22-Mar-93	382	308	MADRAS	22-Mar-93 22-Mar-93	Birth Death	591 White-coat colour
779	829	M	22-Mar-93	382	308	MADRAS	22-Mar-93 22-Mar-93	Birth Death	592 White-coat colour
780	828	F	22-Mar-93	382	308	MADRAS	22-Mar-93 22-Mar-93	Birth Death	593 White-coat colour
781	909	F	~ Feb 1993	WILD	WILD	INDIA ASSAM	~ 1993 23-Mar-93 23-Apr-93	Capture Transfer Death	743 Normal- coat colour
782 KARTHIK	831	M	27-Mar-93	401	554	ASSAM	27-Mar-93 17-Feb-04	Birth Death	594 White-coat colour
783 KAMAL	830	M	27-Mar-93	401	554	ASSAM	27-Mar-93 06-Sep-97	Birth Death	595 White-coat colour
784 ASHIMI	832	F	27-Mar-93	401	554	ASSAM	27-Mar-93 27-Dec-93	Birth Death	596 White-coat colour
785	1396	M	12-Apr-93	274	317	PESHWE	12-Apr-93 28-Mar-94	Birth Death	U 348 Normal- coat colour
786	1397	M	28-Apr-93	273	304	JAIPUR	28-Apr-93	Birth Itf	U 181 Normal- coat colour
787	1398	M	28-Apr-93	273	304	JAIPUR	28-Apr-93	Birth Itf	U 182 Normal- coat colour
788	1399	F	28-Apr-93	273	304	JAIPUR	28-Apr-93	Birth Itf	U 183 Normal- coat colour
789 SARASWATI	1400	F	28-Apr-93	454	447	SHIVPURI PATNA SHIVPURI	28-Apr-93 22-Apr-99 29-Oct-01	Birth Transfer Death	U 375 Normal- coat colour
790 TRIVANI	1401	F	28-Apr-93	454	447	SHIVPURI PATNA SHIVPURI	28-Apr-93 22-Apr-99 12-Nov-01	Birth Transfer Death	U 376 Normal- coat colour
791 211	834	M	02-May-93	513	435	NANDANKAN	02-May-93 24-May-93	Birth Death	W 597 White-coat colour
792 212	833	M	02-May-93	513	435	NANDANKAN	02-May-93 02-Jun-93	Birth Death	W 598 White-coat colour
793 213	835	M	02-May-93	513	435	NANDANKAN	02-May-93 04-Jun-93	Birth Death	W 599 White-coat colour
794 JEEVAN	838	M	03-May-93	548	512	BOKARO	03-May-93 ????	Birth Death	600 White-coat colour
795 JACKY	837	M	03-May-93	548	512	BOKARO	03-May-93 ????	Birth Death	601 White-coat colour

National Stud# House Name LocalID Transponder	Int. Std. #	Sex	Birth Date	Sire	Dam	Location	Date	Event	Old NSB # Remarks
796 JAWAHAR	910	M	03-May-93	548	512	BOKARO	03-May-93 06-Apr-94	Birth Death	744 White-coat colour
797 JOHNY	836	M	03-May-93	548	512	BOKARO	03-May-93 01-May-02	Birth Death	W 602 White-coat colour
798 PRABHAT	1402	M	12-May-93	386	432	UDAIPUR	12-May-93	Birth ltf	U 185 Normal- coat colour
799 GAURAV	1403	M	12-May-93	386	432	UDAIPUR	12-May-93	Birth ltf	U 186 Normal- coat colour
800 MINI	839	M	23-May-93	263	361	CHATBIR Z	23-May-93 23-May-93	Birth Death	U 305 Normal- coat colour
801 TINNI	840	F	23-May-93	263	361	CHATBIR Z	23-May-93 11-Aug-93	Birth Death	U 306 Normal- coat colour
802 REKHA	1404	F	25-May-93	452	453	VANVIHAR	25-May-93 27-Nov-96	Birth Death	U 187 Normal- coat colour
803 BEN	1405	M	25-May-93	452	453	VANVIHAR BILASPUR TATA	25-May-93 10-Nov-95 14-Mar-96	Birth Transfer Transfer ltf	U 188 Normal- coat colour
804	1406	M	25-May-93	452	453	VANVIHAR	25-May-93 02-Nov-93	Birth Death	U 189 Normal- coat colour
805 SALMA 10006	1407	F	25-May-93	452	453	VANVIHAR	25-May-93 13-Aug-12	Birth Death	U 190 Normal- coat colour
806	1408	M	30-May-93	UNK	UNK	TRIVANDRU	30-May-93 05-Jun-93	Birth Death	U 243 Normal- coat colour
807	1409	F	30-May-93	UNK	UNK	TRIVANDRU	30-May-93 03-Jul-93	Birth Death	U 244 Normal- coat colour
808 KUNTI	1390	F	~ 1993	UNK	UNK	CHATBIR Z DELHI	~ 1993 30-Mar-01	Birth ltf	U 373 Normal- coat colour
809 PRIYA	1391	F	~ 1993	UNK	UNK	CHATBIR Z DELHI	~ 1993 ~ Mar 2001	Birth ltf	U 374 Normal- coat colour
810 20	843	M	16-Jun-93	218	473	JUNAGADH	16-Jun-93 18-Jun-93	Birth Death	605 Normal- coat colour
811 21	842	M	16-Jun-93	218	473	JUNAGADH	16-Jun-93 19-Jun-93	Birth Death	606 Normal- coat colour
812 22	841	F	16-Jun-93	218	473	JUNAGADH	16-Jun-93 01-Apr-94	Birth Death	607 Normal- coat colour
813 23	844	F	16-Jun-93	218	473	JUNAGADH	16-Jun-93 26-Jun-98	Birth Death	608 Normal- coat colour
814	1410	F	27-Jun-93	592	593	KOTA	27-Jun-93 27-Jun-93	Birth Death	U 377 Normal- coat colour
815	1411	M	27-Jun-93	592	593	KOTA	27-Jun-93 27-Jun-93	Birth Death	U 378 Normal- coat colour

National Stud# House Name LocalID Transponder	Int. Std. #	Sex	Birth Date	Sire	Dam	Location	Date	Event	Old NSB # Remarks
816 215	911	F	29-Aug-93	511	307	NANDANKAN	29-Aug-93 15-Nov-93	Birth Death	745 White-coat colour
817 CHANDAN 214	912	M	29-Aug-93	511	307	NANDANKAN	29-Aug-93 05-Jul-00	Birth Death	W 746 White-coat colour
818 RUPA	1412	F	08-Sep-93	494	UNK	CHATBIR Z	08-Sep-93	Birth ltf	Normal- coat colour
819 BABBI	849	F	18-Sep-93	494	385	CHATBIR Z PIPLI	18-Sep-93 18-Apr-95	Birth ltf	U 307 Normal- coat colour
820 SANTI	851	F	18-Sep-93	494	385	CHATBIR Z	18-Sep-93	Birth ltf	U 308 Normal- coat colour
821 MITTO	850	F	18-Sep-93	494	385	CHATBIR Z	18-Sep-93	Birth ltf	U 309 Normal- coat colour
822 217	852	M	19-Sep-93	423	402	NANDANKAN	19-Sep-93 10-Feb-94	Birth Death	W 616 White-coat colour
823 216	913	F	19-Sep-93	423	402	NANDANKAN	19-Sep-93 06-Feb-94	Birth Death	W 747 White-coat colour
824 218	914	M	19-Sep-93	423	402	NANDANKAN	19-Sep-93 06-Feb-94	Birth Death	W 748 White-coat colour
825 SMEETHA M00074	1413	F	27-Sep-93	371	372	MYSORE	27-Sep-93 11-Oct-05	Birth Death	WU 193 Normal- coat colour
826 PREETHA M00188	1414	F	27-Sep-93	371	372	MYSORE BANNERGHA	27-Sep-93 11-Apr-05	Birth ltf	WU 194 Normal- coat colour
827 REETHA M00083 0006B73E54	1415	F	27-Sep-93	371	372	MYSORE	27-Sep-93	Birth ltf	WU 195 Normal- coat colour
828 MILI	853	M	19-Oct-93	457	328	PATNA	19-Oct-93 03-May-97	Birth Death	617 White-coat colour
829 SARFARAZ	854	M	19-Oct-93	457	328	PATNA	19-Oct-93 16-Mar-96	Birth Death	618 White-coat colour
830 222	855	F	23-Oct-93	513	435	NANDANKAN	23-Oct-93 07-Feb-95	Birth Death	W 619 White-coat colour
831 RAJAN M00195	856	M	23-Oct-93	513	435	NANDANKAN MYSORE	23-Oct-93 06-Dec-96 19-Jun-06	Birth Transfer Death	W 620 White-coat colour
832 220	857	M	23-Oct-93	513	435	NANDANKAN	23-Oct-93 28-Sep-94	Birth Death	W 621 White-coat colour
833 221	858	M	23-Oct-93	513	435	NANDANKAN	23-Oct-93 27-Jan-95	Birth Death	W 622 White-coat colour
834 MOOKANBIKA	1417	F	25-Oct-93	596	281	SHIMOGA	25-Oct-93 05-Jul-94	Birth Death	U 202 Normal- coat colour
835 CHAMUNDI	1418	F	25-Oct-93	596	281	SHIMOGA	25-Oct-93	Birth ltf	U 358 Normal- coat colour

National Stud# House Name LocalID Transponder	Int. Std. #	Sex	Birth Date	Sire	Dam	Location	Date	Event	Old NSB # Remarks
836 SURESH	859	M	28-Oct-93	382	308	MADRAS	28-Oct-93 05-Jun-94	Birth Death	623 White-coat colour
837 THAMBU	863	M	28-Oct-93	382	308	MADRAS	28-Oct-93 01-Jun-00	Birth Death	624 White-coat colour
838 BATHMA	860	F	28-Oct-93	382	308	MADRAS	28-Oct-93 17-Jan-16	Birth Death	625 White-coat colour
839 VALLI 00061163 ED	861	F	28-Oct-93	382	308	MADRAS	28-Oct-93	Birth ltf	626 White-coat colour
840 CHELLAM	862	F	28-Oct-93	382	308	MADRAS	28-Oct-93 08-Sep-95	Birth Death	627 White-coat colour
841 LEELA	1419	F	20-Nov-93	242	157	BANNERGHA	20-Nov-93 14-Dec-05	Birth Death	U 197 Normal- coat colour
842 PUSHPA	1420	F	20-Nov-93	242	157	BANNERGHA BORIVILLI	20-Nov-93 17-Oct-98 01-Feb-01	Birth Transfer Death	U 198 Normal- coat colour
843	1421	M	21-Nov-93	387	432	KOTA	21-Nov-93 21-Nov-93	Birth Death	U 379 Normal- coat colour
844 RADHA	1422	F	21-Nov-93	387	432	KOTA UDAIPUR	21-Nov-93 11-Jul-00	Birth Transfer	U 380 Normal- coat colour
845 RUKMANI	1423	F	21-Nov-93	387	432	KOTA UDAIPUR	21-Nov-93 11-Jul-00	Birth Transfer	U 381 Normal- coat colour
846 RAJA 225	915	M	02-Dec-93	442	344	NANDANKAN AHMEDABAD	02-Dec-93 05-Apr-98 13-Apr-09	Birth Transfer Death	657 White-coat colour
847 SHAILAJA 223	916	F	02-Dec-93	442	344	NANDANKAN	02-Dec-93	Birth ltf	749 White-coat colour
848 TANUJA 224	917	F	02-Dec-93	442	344	NANDANKAN	02-Dec-93 17-Nov-11	Birth Death	750 White-coat colour
849	1426	F	13-Jan-94	274	395	PESHWE	13-Jan-94 09-Apr-99	Birth Death	U 351 White-coat colour
850	1424	M	13-Jan-94	274	395	PESHWE	13-Jan-94 29-Jan-95	Birth Death	U 349 Normal- coat colour
851 MASTANI 000-63B7-A3E	1425	F	13-Jan-94	274	395	PESHWE PUNE	13-Jan-94 ???? 28-Sep-09	Birth Transfer Death	U 350 Normal- coat colour
852 SHANKRI	1183	F	~ 1988	WILD	WILD	INDIA RAIPUR	~14 Jan 1994 14-Jan-94 18-Nov-10	Capture Transfer Death	Normal- coat colour
853	865	?	20-Jan-94	339	247	VISAKAPAT	20-Jan-94 20-Jan-94	Birth Death	628 Normal- coat colour
854	864	?	20-Jan-94	339	247	VISAKAPAT	20-Jan-94 20-Jan-94	Birth Death	629 Normal- coat colour
855	866	?	20-Jan-94	339	247	VISAKAPAT	20-Jan-94 20-Jan-94	Birth Death	630 Normal- coat colour

National Stud# House Name LocalID Transponder	Int. Std. #	Sex	Birth Date	Sire	Dam	Location	Date	Event	Old NSB # Remarks
856 LACHI	1427	F	04-Jun-94	494	566	CHATBIR Z	04-Jun-94	Birth Itf	U 310 Normal-coat colour
857 GALORI	1428	F	04-Jun-94	494	566	CHATBIR Z	04-Jun-94	Birth Itf	U 311 Normal-coat colour
858 RUKMINI 227	923	F	06-Jun-94	346	342	NANDANKAN	06-Jun-94 18-Sep-96	Birth Death	753 White-coat colour
859 ASHOK-II 226	922	M	06-Jun-94	346	342	NANDANKAN	06-Jun-94 20-Aug-11	Birth Death	752 White-coat colour
860 MUNNI BT0055	869	F	07-Jun-94	606	567	HYDERABAD	07-Jun-94 05-Sep-16	Birth Death	658 White-coat colour
861 MURALI BT0054	868	M	07-Jun-94	606	567	HYDERABAD	07-Jun-94 16-Dec-96	Birth Death	W 659 White-coat colour
862 MUKESH BT0053	867	F	07-Jun-94	606	567	HYDERABAD	07-Jun-94 18-Sep-95	Birth Death	W 754 White-coat colour
863 BALRAM	1184	M	~ Sep 1993	WILD	WILD	INDIA VANVIHAR	~12 Jun 1994 12-Jun-94 11-Feb-98	Capture Transfer Death	Normal-coat colour
864 RAM	920	M	~ Jan 1994	WILDB1	WILDB2	INDIA VANVIHAR	~ 1994 12-Jun-94 15-Jun-06	Capture Transfer Death	721 Normal-coat colour
865 SEETA	921	F	~ Jan 1994	WILDB1	WILDB2	INDIA VANVIHAR	~ 1994 12-Jun-94 31-May-14	Capture Transfer Death	722 Normal-coat colour
866 GEETA	919	F	~ Jan 1994	WILDB1	WILDB2	INDIA VANVIHAR DELHI	~ 1994 12-Jun-94 11-Feb-98 20-May-00	Capture Transfer Transfer Death	751 Normal-coat colour
867		M	14-Jul-94	401	380	ASSAM	14-Jul-94 14-Jul-94	Birth Death	White-coat colour
868		F	14-Jul-94	401	380	ASSAM	14-Jul-94 14-Jul-94	Birth Death	White-coat colour
869 AMAR 230	924	M	26-Jul-94	306	297	NANDANKAN	26-Jul-94 31-Aug-95	Birth Death	755 White-coat colour
870 AJIT 228	925	M	26-Jul-94	306	297	NANDANKAN	26-Jul-94 05-Dec-95	Birth Death	W 756 White-coat colour
871 NUTAN 229	926	F	26-Jul-94	306	297	NANDANKAN	26-Jul-94 12-Feb-99	Birth Death	W 757 White-coat colour
872 REENA	1429	F	30-Jul-94	452	529	VANVIHAR	30-Jul-94 25-Apr-13	Birth Death	U 204 Normal-coat colour
873	1430	F	30-Jul-94	452	529	VANVIHAR	30-Jul-94 17-Mar-95	Birth Death	U 205 Normal-coat colour
874	1431	M	30-Jul-94	452	529	VANVIHAR	30-Jul-94 12-Jul-95	Birth Death	U 206 Normal-coat colour
875	1432	M	30-Jul-94	452	529	VANVIHAR	30-Jul-94 11-Oct-95	Birth Death	U 207 Normal-coat colour
876 231	927	M	23-Sep-94	295	300	NANDANKAN	23-Sep-94 23-Sep-94	Birth Death	758 Normal-coat colour

National Stud# House Name LocalID Transponder	Int. Std. #	Sex	Birth Date	Sire	Dam	Location	Date	Event	Old NSB # Remarks
877 232	928	F	23-Sep-94	295	300	NANDANKAN	23-Sep-94 24-Sep-94	Birth Death	759 Normal- coat colour
878 TANYA 233	929	F	01-Nov-94	625	402	NANDANKAN	01-Nov-94 06-Jul-97	Birth Death	W 760 White-coat colour
879 JANAKI 234	930	F	01-Nov-94	625	402	NANDANKAN	01-Nov-94 10-Feb-98	Birth Death	W 761 White-coat colour
880 235	931	F	01-Nov-94	625	402	NANDANKAN	01-Nov-94 09-Feb-95	Birth Death	W 762 White-coat colour
881 JANAK 236	932	M	01-Nov-94	625	402	NANDANKAN	01-Nov-94 05-Jul-00	Birth Death	W 763 White-coat colour
882	1079	F	14-Nov-94	339	340	VISAKAPAT	14-Nov-94 11-Jun-02	Birth Death	887 Normal- coat colour
883 RAHUL BT0056	870	M	08-Dec-94	510	604	HYDERABAD	08-Dec-94 12-Dec-05	Birth Death	661 Normal- coat colour
884 RAMYA BT0057	871	F	08-Dec-94	510	604	HYDERABAD	08-Dec-94 31-Dec-02	Birth Death	662 Normal- coat colour
885 240	933	F	09-Jan-95	511	307	NANDANKAN	09-Jan-95 06-Feb-95	Birth Death	764 White-coat colour
886 LAXMAN	934	M	09-Jan-95	511	307	NANDANKAN DELHI	09-Jan-95 18-Jul-99	Birth Transfer	W 663 White-coat colour
887 SHOBAN	935	M	09-Jan-95	511	307	NANDANKAN	09-Jan-95 14-Jul-98	Birth Death	W 765 White-coat colour
888	1433	F	15-Feb-95	274	317	PESHWE	15-Feb-95 05-May-99	Birth Death	U 352 Normal- coat colour
889 BAJIRAO	1434	M	15-Feb-95	274	317	PESHWE PUNE	15-Feb-95 ???? 08-Jun-06	Birth Transfer Death	U 353 Normal- coat colour
890 CHILKA	918	F	????	WILD	WILD	INDIA LUCKNOW	???? ???? 21-Feb-95	Capture Transfer Death	883 Normal- coat colour
891 GUDDU 401	1157	M	01-Mar-95	412	385	CHATBIR Z KANPUR LUCKNOW	01-Mar-95 12-Jul-00 04-Apr-01 01-Jan-14	Birth Transfer Transfer Death	Normal- coat colour
892 GYANO	1436	M	01-Mar-95	412	385	CHATBIR Z	01-Mar-95	Birth	U 313 Normal- coat colour
893 DEEPA	1437	F	01-Mar-95	412	385	CHATBIR Z	01-Mar-95 20-Mar-04	Birth Death	U 314 Normal- coat colour
894 RANI 0006B75070	1080	F	19-Mar-95	250	247	VISAKAPAT	19-Mar-95	Birth	888 Normal- coat colour
895 LALOO 0006B823BF	881	M	06-Apr-95	450	658	INDORE	06-Apr-95	Birth	766 Normal- coat colour
896 BIHARI 0006B817DF	880	M	06-Apr-95	450	658	INDORE	06-Apr-95	Birth	767 Normal- coat colour

National Stud# House Name LocalID Transponder	Int. Std. #	Sex	Birth Date	Sire	Dam	Location	Date	Event	Old NSB # Remarks
897 LUCKY	879	M	06-Apr-95	450	658	INDORE	06-Apr-95	Birth	768 Normal-coat colour
898 DEVI	874	F	08-Apr-95	382	308	MADRAS	08-Apr-95 16-Oct-13	Birth Death	664 White-coat colour
899 DEVAN	872	M	08-Apr-95	382	308	MADRAS	08-Apr-95 15-Sep-97	Birth Death	665 White-coat colour
900 KUMARI	873	F	08-Apr-95	382	308	MADRAS	08-Apr-95 11-Jan-97	Birth Death	666 White-coat colour
901	1438	M	13-Apr-95	656	657	JAIPUR	13-Apr-95 16-Apr-95	Birth Death	U 265 Normal-coat colour
902	1439	M	13-Apr-95	656	657	JAIPUR	13-Apr-95 14-Jun-95	Birth Death	U 266 Normal-coat colour
903 MAHAVEER	1440	M	13-Apr-95	656	657	JAIPUR	13-Apr-95 ~ 2000	Birth Death	U 267 Normal-coat colour
904	1441	M	13-Apr-95	656	657	JAIPUR	13-Apr-95 14-Apr-95	Birth Death	WU 264 Normal-coat colour
905 GAURAV 3KAN6 00-001E-FDBF 24	875	M	23-Apr-95	430	439	KANPUR JUNAGADH GANDHINAG	23-Apr-95 11-Nov-98 19-Sep-09 25-Aug-13	Birth Transfer Transfer Death	699 White-coat colour
906 MONA 3KAN5	876	F	23-Apr-95	430	439	KANPUR GWALIOR	23-Apr-95 27-Sep-98	Birth Transfer	769 White-coat colour
907 SONA 3KAN4	877	F	23-Apr-95	430	439	KANPUR LUCKNOW	23-Apr-95 21-Jul-03 08-Aug-15	Birth Transfer Death	W 770 White-coat colour
908	1442	F	03-May-95	274	395	PESHWE	03-May-95 10-Jun-98	Birth Death	U 354 Normal-coat colour
909	1443	M	03-May-95	274	395	PESHWE	03-May-95 24-Jan-96	Birth Death	U 355 Normal-coat colour
910 BADAL 0006B744C3	936	M	09-Jun-95	639	476	NANDANKAN VISAKAPAT TIRUPATI	09-Jun-95 22-Sep-00 17-Dec-00	Birth Transfer Transfer	771 White-coat colour
911 SURYA/Rudra	937	M	09-Jun-95	639	476	NANDANKAN VISAKAPAT	09-Jun-95 22-Sep-00	Birth Transfer	W 772 White-coat colour
912 242	938	F	09-Jun-95	639	476	NANDANKAN	09-Jun-95 09-Jul-96	Birth Death	W 773 White-coat colour
913 BHADRA	939	F	12-Jun-95	680	281	SHIMOGA	12-Jun-95 04-Nov-99	Birth Death	667 Normal-coat colour
914 TUNGA	940	F	12-Jun-95	680	281	SHIMOGA	12-Jun-95 29-Sep-96	Birth Death	774 Normal-coat colour
915 RAJA	941	M	21-Jun-95	548	512	BOKARO	21-Jun-95 01-Jun-96	Birth Death	775 White-coat colour
916 SITA	942	F	21-Jun-95	548	512	BOKARO	21-Jun-95 07-Feb-96	Birth Death	776 White-coat colour

National Stud# House Name LocalID Transponder	Int. Std. #	Sex	Birth Date	Sire	Dam	Location	Date	Event	Old NSB # Remarks
917 GITA	943	F	21-Jun-95	548	512	BOKARO	21-Jun-95 26-Dec-95	Birth Death	777 White-coat colour
918	882	M	30-Jun-95	700	607	TATA	30-Jun-95 21-Aug-95	Birth Death	644 White-coat colour
919	883	M	30-Jun-95	700	607	TATA	30-Jun-95 28-Aug-95	Birth Death	645 White-coat colour
920	884	F	30-Jun-95	700	607	TATA	30-Jun-95 30-Aug-95	Birth Death	646 White-coat colour
921	885	F	30-Jun-95	700	607	TATA	30-Jun-95 01-Sep-95	Birth Death	647 White-coat colour
922	1444	F	08-Jul-95	UNK	821	CHATBIR Z	08-Jul-95	Birth Itf	U 315 Normal- coat colour
923	1445	F	08-Jul-95	UNK	821	CHATBIR Z	08-Jul-95	Birth Itf	U 316 Normal- coat colour
924 244	944	?	23-Jul-95	513	435	NANDANKAN	23-Jul-95 23-Jul-95	Birth Death	W 779 White-coat colour
925 245	945	?	23-Jul-95	513	435	NANDANKAN	23-Jul-95 23-Jul-95	Birth Death	W 780 White-coat colour
926 246	946	M	23-Jul-95	513	435	NANDANKAN	23-Jul-95 28-Jul-95	Birth Death	W 781 White-coat colour
927 KANHA	887	M	30-Jun-91	WILD1	WILD2	MUKKI LUCKNOW	~ 1995 27-Sep-95	Capture Transfer	639 Normal- coat colour
928 LAJWANTI	888	F	~ 1991	WILD1	WILD2	MUKKI LUCKNOW	~ 1995 27-Sep-95 03-Nov-98	Capture Transfer Death	640 Normal- coat colour
929 SAMRAHI	889	F	~ 1991	WILD1	WILD2	MUKKI LUCKNOW	~ 1995 27-Sep-95 20-Dec-97	Capture Transfer Death	641 Normal- coat colour
930 KUMADVATHI	947	F	29-Jul-95	680	681	SHIMOGA	29-Jul-95 01-Sep-00	Birth Death	668 Normal- coat colour
931 MADHUKESHWA R000-6B74-3D3 M00079	948	M	29-Jul-95	680	681	SHIMOGA MYSORE	29-Jul-95 14-Feb-02 20-Aug-13	Birth Transfer Death	669 Normal- coat colour
932 247	949	F	07-Aug-95	295	300	NANDANKAN	07-Aug-95 14-Aug-95	Birth Death	782 Normal- coat colour
933 ANUSUYA 98102058015	950	F	07-Aug-95	295	300	NANDANKAN	07-Aug-95 10-Nov-10	Birth Death	783 Normal- coat colour
934 SEPHALI	1446	F	18-Oct-95	617	566	LUCKNOW	18-Oct-95 07-Dec-01	Birth Death	U 338 Normal- coat colour
935 DEEPALI	1447	F	18-Oct-95	617	566	LUCKNOW BORIVILLI	18-Oct-95 18-Mar-98	Birth Transfer	U 339 Normal- coat colour
936 RUPALI	1448	F	18-Oct-95	617	566	LUCKNOW BORIVILLI	18-Oct-95 18-Mar-98 26-Dec-98	Birth Transfer Death	U 340 Normal- coat colour

National Stud# House Name LocalID Transponder	Int. Std. #	Sex	Birth Date	Sire	Dam	Location	Date	Event	Old NSB # Remarks
937 RAM	1449	M	20-Nov-95	454	447	SHIVPURI PATNA	20-Nov-95 22-Apr-99 10-May-11	Birth Transfer Death	U 382 Normal- coat colour
938 SITA	1450	F	20-Nov-95	454	447	SHIVPURI PATNA	20-Nov-95 22-Apr-99 30-Dec-14	Birth Transfer Death	U 383 Normal- coat colour
939 SEEMA 250	951	F	19-Dec-95	511	307	NANDANKAN AHMEDABAD	19-Dec-95 05-Apr-98 11-Jul-11	Birth Transfer Death	670 White-coat colour
940 RIMA 249	952	F	19-Dec-95	511	307	NANDANKAN LUCKNOW	19-Dec-95 25-Nov-97 26-Jul-02	Birth Transfer Death	784 White-coat colour
941 251	953	F	19-Dec-95	511	307	NANDANKAN	19-Dec-95 25-Dec-95	Birth Death	W 785 White-coat colour
942 SUSHMA	954	F	19-Dec-95	511	307	NANDANKAN	19-Dec-95 03-Jul-16	Birth Death	786 White-coat colour
943 JWALA	1081	F	~ 1994	WILDB3	WILDB4	INDIA BILASPUR	08-Jan-96 14-Mar-96	Capture Transfer	884 Normal- coat colour
944 LAWA	1082	F	~ 1994	WILDB3	WILDB4	INDIA BILASPUR	08-Jan-96 14-Mar-96	Capture Transfer	886 Normal- coat colour
945 BHAVANI	1451	F	30-Jan-96	268	677	BANNERGHA	30-Jan-96	Birth	U 214 Normal- coat colour
946 YASHODA	1452	F	30-Jan-96	268	677	BANNERGHA	30-Jan-96	Birth	U 215 Normal- coat colour
947 KIRAN	1453	M	30-Jan-96	268	677	BANNERGHA BORIVILLI	30-Jan-96 17-Oct-98 04-Feb-02	Birth Transfer Death	U 216 Normal- coat colour
948 SABINA	956	M	26-Feb-96	346	342	NANDANKAN VISAKAPAT	26-Feb-96 22-Sep-00	Birth Itf	787 White-coat colour
949 NISHAN 254	957	M	26-Feb-96	346	342	NANDANKAN	26-Feb-96 06-Aug-14	Birth Death	788 White-coat colour
950 SUMITHRA BT0061	958	F	18-Mar-96	309	310	HYDERABAD	18-Mar-96 21-Feb-11	Birth Death	W 673 White-coat colour
951 RUPESH 255	959	M	18-Mar-96	513	435	NANDANKAN LUCKNOW	18-Mar-96 26-Nov-97 05-Oct-13	Birth Transfer Death	W 789 White-coat colour
952 ASHISH	960	M	18-Mar-96	513	435	NANDANKAN MALAYSIA	18-Mar-96 08-Mar-98	Birth Itf	W 790 White-coat colour
953 257	961	F	18-Mar-96	513	435	NANDANKAN	18-Mar-96 11-Feb-97	Birth Death	W 791 White-coat colour
954 NANDINI 258	962	F	18-Mar-96	513	435	NANDANKAN MALAYSIA	18-Mar-96 08-Mar-98	Birth Itf	W 792 White-coat colour
955 MADHURI M00193	1454	F	22-Mar-96	268	595	BANNERGHA MYSORE	22-Mar-96 10-Jul-96 01-Sep-97	Birth Transfer Death	U 366 Normal- coat colour
956 SUNIL M00191	1455	M	22-Mar-96	268	595	BANNERGHA MYSORE CALCUTTA	22-Mar-96 10-Jul-96 23-Apr-05	Birth Transfer Transfer	U 385 Normal- coat colour

National Stud# House Name LocalID Transponder	Int. Std. #	Sex	Birth Date	Sire	Dam	Location	Date	Event	Old NSB # Remarks
957 ANIL M00192	1456	M	22-Mar-96	268	595	BANNERGHA MYSORE	22-Mar-96 10-Jul-96 05-Sep-97	Birth Transfer Death	U 386 Normal- coat colour
958 BANTOO	963	M	03-Apr-96	650	355	BHILAI	03-Apr-96 19-Jan-02	Birth Death	793 Normal- coat colour
959 BANTI	964	F	03-Apr-96	650	355	BHILAI	03-Apr-96 25-Feb-02	Birth Death	794 Normal- coat colour
960 259	965	M	16-Apr-96	700	729	NANDANKAN	16-Apr-96 16-Apr-96	Birth Death	795 White-coat colour
961 260	966	F	16-Apr-96	700	729	NANDANKAN	16-Apr-96 18-Apr-96	Birth Death	796 White-coat colour
962	1457	M	24-Apr-96	592	432	KOTA	24-Apr-96 25-Dec-96	Birth Death	Normal- coat colour
963 RANI 0006CBEA63	967	F	06-Jun-96	684	733	AURANGABA	06-Jun-96	Birth	W 797 White-coat colour
964	968	M	06-Jun-96	684	733	AURANGABA	06-Jun-96 17-Oct-96	Birth Death	W 798 White-coat colour
965 SIDDHARTH	978	M	06-Jun-96	684	733	AURANGABA BORIVILLI	06-Jun-96 25-Aug-98	Birth Transfer	W 805 White-coat colour
966 PUSHPA	955	F	~ 1993	WILD	WILD	INDIA	~ 1996 29-Dec-99	Capture Death	723 Normal- coat colour
967		M	23-Jun-96	401	380	ASSAM	23-Jun-96 23-Jun-96	Birth Death	White-coat colour
968		F	23-Jun-96	401	380	ASSAM	23-Jun-96 23-Jun-96	Birth Death	White-coat colour
969 RAMU	970	M	26-Jun-96	650	755	BHILAI	26-Jun-96 27-Mar-05	Birth Death	800 Normal- coat colour
970 GEETA	971	F	26-Jun-96	650	755	BHILAI	26-Jun-96 13-Jul-99	Birth Death	801 Normal- coat colour
971 MAHESHWARA	1458	M	26-Jul-96	268	706	BANNERGHA	26-Jul-96 07-Jan-98	Birth Death	U 217 Normal- coat colour
972 GURU	1459	M	26-Jul-96	268	706	BANNERGHA	26-Jul-96	Birth	U 218 Normal- coat colour
973 BRAHMA	1460	F	26-Jul-96	268	706	BANNERGHA	26-Jul-96	Birth	U 219 Normal- coat colour
974 LAXHMI	1461	F	26-Jul-96	268	706	BANNERGHA	26-Jul-96	Birth	U 220 Normal- coat colour
975 PUSPA	1185	F	~ Jan 1994	WILD	WILD	INDIA VANVIHAR	~27 Jul 1996 27-Jul-96 28-Dec-99	Capture Transfer Death	Normal- coat colour
976 MONGHI	899	F	26-Sep-96	530	730	RAJKOT SURAT	26-Sep-96 14-Apr-02	Birth Transfer	677 White-coat colour
977 MOHAN	898	M	26-Sep-96	530	730	RAJKOT	26-Sep-96 24-Oct-98	Birth Death	678 White-coat colour

National Stud# House Name LocalID Transponder	Int. Std. #	Sex	Birth Date	Sire	Dam	Location	Date	Event	Old NSB # Remarks
978 TOHIMA 3KAN7	972	F	30-Oct-96	430	439	KANPUR JUNAGADH	30-Oct-96 11-Nov-98	Birth Transfer	682 White-coat colour
979 SUNNY 3KAN9	973	M	30-Oct-96	430	439	KANPUR	30-Oct-96	Birth	802 White-coat colour
980 AISHWARYA 3KAN8	974	F	30-Oct-96	430	439	KANPUR JUNAGADH	30-Oct-96 11-Nov-98	Birth Transfer	W 683 White-coat colour
981 SHERU	1462	M	30-Nov-96	412	695	CHATBIR Z UNKNOWN	30-Nov-96 17-Jul-97	Birth Itf	Normal- coat colour
982 CHANDU	1463	F	30-Nov-96	412	695	CHATBIR Z PIPLI	30-Nov-96 17-Jul-97 ????	Birth Transfer Death	Normal- coat colour
983 CHANDANI	1464	F	30-Nov-96	412	821	CHATBIR Z PIPLI	30-Nov-96 17-Feb-97 ????	Birth Transfer Death	U 318 Normal- coat colour
984 ARJUN	1466	M	~ Jan 1997	UNK	UNK	DARJEELIN	~ Jan 1997 27-Nov-07	Birth Death	Normal- coat colour
985 BHADURII	969	M	21-Jan-97	684	733	AURANGABA	21-Jan-97 25-Dec-98	Birth Death	W 799 White-coat colour
986 RABICA 006CBC6CC	977	F	21-Jan-97	684	733	AURANGABA BORIVILLI	21-Jan-97 02-Dec-10	Birth Transfer	W 804 White-coat colour
987 RENUKA	979	F	21-Jan-97	684	733	AURANGABA BORIVILLI	21-Jan-97 25-Aug-98	Birth Transfer	W 806 White-coat colour
988 261	976	F	21-Jan-97	700	729	NANDANKAN	21-Jan-97 22-Jan-97	Birth Death	803 White-coat colour
989 THUNGA	1467	F	28-Jan-97	680	835	SHIMOGA	28-Jan-97	Birth	Normal- coat colour
990 RAJA 9.81098E+1232	1468	M	28-Jan-97	680	835	SHIMOGA MANGALORE	28-Jan-97 25-Nov-03	Birth Transfer	U 359 Normal- coat colour
991 SWATHI	1469	F	28-Jan-97	680	835	SHIMOGA ASSAM	28-Jan-97 19-Feb-05 16-Jul-17	Birth Transfer Death	U 360 Normal- coat colour
992 KRUTHIKA	1470	F	28-Jan-97	680	835	SHIMOGA	28-Jan-97	Birth	U 361 Normal- coat colour
993 RAZIA 000-6A29-63E	1471	F	03-Feb-97	645	317	PESHWE PUNE	03-Feb-97 ???? 12-Jan-15	Birth Transfer Death	U 357 Normal- coat colour
994 GYPSY 000-6A28-CFE	1472	F	03-Feb-97	645	317	PESHWE PUNE	03-Feb-97 03-Feb-97 07-Dec-12	Birth Transfer Death	WU 356 Normal- coat colour
995	1473	?	17-Feb-97	UNK	UNK	CHATBIR Z	17-Feb-97	Birth Itf	U 319 Normal- coat colour
996	1474	?	17-Feb-97	UNK	UNK	CHATBIR Z	17-Feb-97	Birth Itf	U 320 Normal- coat colour
997 ANIRBAN(W)	1475	M	28-Mar-97	373	613	CALCUTTA	28-Mar-97	Birth	WU 257 White-coat colour
998 SANDHYA	1465	F	????	UNK	UNK	UDAIPUR JODHPUR	???? 21-Apr-97	Birth Transfer	Normal- coat colour
999 SHANTHALA M00185	980	F	23-Apr-97	680	681	SHIMOGA MYSORE	23-Apr-97 14-Feb-02 08-Jun-02	Birth Transfer Death	688 Normal- coat colour

National Stud# House Name LocalID Transponder	Int. Std. #	Sex	Birth Date	Sire	Dam	Location	Date	Event	Old NSB # Remarks
1000 BHARAT M00196	1476	M	09-May-97	272	608	MYSORE TRIVANDRU TRICHUR	09-May-97 11-Dec-01 01-Jun-04 16-May-10	Birth Transfer Transfer Death	U 208 Normal- coat colour
1001 KARISHMA M00197	1477	F	09-May-97	272	608	MYSORE TRIVANDRU	09-May-97 11-Dec-01	Birth Transfer	U 209 Normal- coat colour
1002	975	F	????	WILD	WILD	INDIA JAIPUR	~ 1997 16-May-97 18-May-97	Capture Transfer Death	882 Normal- coat colour
1003	982	M	16-May-97	639	476	NANDANKAN	16-May-97 09-Jun-97	Birth Death	W 808 White-coat colour
1004	981	M	16-May-97	639	476	NANDANKAN	16-May-97 24-May-97	Birth Death	807 White-coat colour
1005 JAWALA	1478	F	31-May-97	412	821	CHATBIR Z PIPLI	31-May-97 17-Jul-97 29-Mar-02	Birth Transfer Death	U 317 Normal- coat colour
1006 BALI	1479	M	31-May-97	489	695	CHATBIR Z	31-May-97 17-Jul-97	Birth Death	U 321 Normal- coat colour
1007 SHIAMI	1480	F	31-May-97	489	818	CHATBIR Z	31-May-97 14-Sep-08	Birth Death	U 322 Normal- coat colour
1008 JIMMY	1481	M	31-May-97	489	818	CHATBIR Z	31-May-97	Birth	U 323 Normal- coat colour
1009 KUNTI	1482	F	31-May-97	489	695	CHATBIR Z DELHI	31-May-97 17-Apr-01	Birth Transfer	U 324 Normal- coat colour
1010	1483	?	31-May-97	UNK	UNK	CHATBIR Z	31-May-97	Birth Itf	U 325 Normal- coat colour
1011	1484	M	26-Jun-97	584	585	KOTA	26-Jun-97 26-Jun-97	Birth Death	U 387 Normal- coat colour
1012 KRISHNA	1485	M	26-Jun-97	584	585	KOTA PIPLI	26-Jun-97 13-Nov-03	Birth Itf	U 388 Normal- coat colour
1013 GEETA	1486	F	26-Jun-97	584	585	KOTA	26-Jun-97 31-Mar-07	Birth Death	U 389 Normal- coat colour
1014 SITA	1487	F	26-Jun-97	584	585	KOTA JAIPUR	26-Jun-97 24-Jan-04	Birth Transfer	U 390 Normal- coat colour
1015 VANITHA	984	F	30-Jun-97	606	567	HYDERABAD JUNAGADH	30-Jun-97 02-Mar-00 01-Dec-00	Birth Transfer Death	692 White-coat colour
1016 KAVITHA	983	F	30-Jun-97	606	567	HYDERABAD	30-Jun-97	Birth	W 691 White-coat colour
1017	1488	M	02-Jul-97	592	593	KOTA	02-Jul-97 02-Jul-97	Birth Death	U 391 Normal- coat colour
1018 BHARAT	1489	M	02-Jul-97	592	593	KOTA JAIPUR	02-Jul-97 24-Jan-04	Birth Transfer	U 392 Normal- coat colour
1019 SHATRUGAN	1490	M	02-Jul-97	592	593	KOTA	02-Jul-97	Birth	U 393 Normal- coat colour

National Stud# House Name LocalID Transponder	Int. Std. #	Sex	Birth Date	Sire	Dam	Location	Date	Event	Old NSB # Remarks
1020	985	F	15-Jul-97	700	729	NANDANKAN	15-Jul-97 18-Jul-97	Birth Death	809 White-coat colour
1021 SUKANTI	986	F	15-Jul-97	700	729	NANDANKAN	15-Jul-97 26-May-07	Birth Death	810 White-coat colour
1022 KUNTI	987	F	15-Jul-97	700	729	NANDANKAN	15-Jul-97 13-Sep-15	Birth Death	W 811 White-coat colour
1023 RENU	1491	F	05-Aug-97	489	695	CHATBIR Z	05-Aug-97 13-Oct-06	Birth Death	U 326 Normal- coat colour
1024 KAMLESH 0006CD0B18	1492	F	05-Aug-97	489	695	CHATBIR Z AURANGABA INDORE	05-Aug-97 07-Dec-05 10-Aug-11	Birth Transfer Transfer	U 327 Normal- coat colour
1025 GAGAN	1493	F	05-Aug-97	489	695	CHATBIR Z	05-Aug-97 31-Aug-05	Birth Death	U328 Normal- coat colour
1026 FATTU	1494	M	05-Aug-97	489	695	CHATBIR Z	05-Aug-97	Birth ltf	U 329 Normal- coat colour
1027	1495	M	05-Aug-97	UNK	UNK	CHATBIR Z	05-Aug-97	Birth ltf	U 330 Normal- coat colour
1028 ABINASH	988	M	04-Oct-97	626	402	NANDANKAN	04-Oct-97 07-Jul-00	Birth Death	W 812 White-coat colour
1029 ANEESH	989	M	04-Oct-97	626	402	NANDANKAN	04-Oct-97 05-Jul-00	Birth Death	W 813 White-coat colour
1030 269	990	M	04-Oct-97	626	402	NANDANKAN	04-Oct-97 16-Oct-97	Birth Death	W 814 White-coat colour
1031 ANANYA	1496	F	16-Oct-97	373	613	CALCUTTA	16-Oct-97	Birth	WU 258 White-coat colour
1032 MALAYA	991	M	19-Oct-97	639	476	NANDANKAN MALAYSIA	19-Oct-97 02-Mar-99	Birth ltf	815 White-coat colour
1033 PRATIBHA	992	F	19-Oct-97	639	476	NANDANKAN	19-Oct-97 22-Nov-98	Birth Death	816 White-coat colour
1034 273	994	?	19-Oct-97	442	759	NANDANKAN	19-Oct-97 01-Nov-97	Birth Death	817 White-coat colour
1035 274	995	?	19-Oct-97	442	759	NANDANKAN	19-Oct-97 01-Nov-97	Birth Death	818 White-coat colour
1036	996	?	19-Oct-97	442	759	NANDANKAN	19-Oct-97 08-Feb-98	Birth Death	819 White-coat colour
1037 SURYA	993	M	19-Oct-97	639	476	NANDANKAN	19-Oct-97 12-Jul-00	Birth Death	W 820 White-coat colour
1038	997	?	19-Oct-97	442	759	NANDANKAN	19-Oct-97 30-Oct-97	Birth Death	W 821 White-coat colour
1039	998	?	19-Oct-97	442	759	NANDANKAN	19-Oct-97 26-Nov-97	Birth Death	W 822 White-coat colour

National Stud# House Name LocalID Transponder	Int. Std. #	Sex	Birth Date	Sire	Dam	Location	Date	Event	Old NSB # Remarks
1040	1497	M	04-Nov-97	592	432	KOTA	04-Nov-97 20-Dec-99	Birth Death	U 394 Normal-coat colour
1041 RAMU		M	15-Jan-98	684	733	AURANGABA	15-Jan-98	Birth	White-coat colour
1042 SHAMMU	1000	M	15-Jan-98	684	733	AURANGABA INDORE	15-Jan-98 05-May-08	Birth Transfer	W 823 White-coat colour
1043 GEETA 0006CC0F62	1001	F	15-Jan-98	684	733	AURANGABA	15-Jan-98 24-Jun-16	Birth Death	W 824 White-coat colour
1044 SEETA	1002	F	15-Jan-98	684	733	AURANGABA INDORE	15-Jan-98 05-May-08	Birth Transfer	W 825 White-coat colour
1045 REETA 0006CC3D21	1003	F	15-Jan-98	684	733	AURANGABA TATA	15-Jan-98 09-Dec-10	Birth Transfer	W 826 White-coat colour
1046 NAINA	1005	F	29-Jan-98	606	567	HYDERABAD	29-Jan-98 25-Jan-00	Birth Death	695 White-coat colour
1047 VINAY	1004	M	29-Jan-98	606	567	HYDERABAD	29-Jan-98	Birth	W 694 White-coat colour
1048 HARISHCHAND	1498	M	24-Mar-98	268	705	BANNERGHA	24-Mar-98	Birth	U 221 Normal-coat colour
1049 RAJESHWARI	1499	F	24-Mar-98	268	705	BANNERGHA	24-Mar-98	Birth	U 222 Normal-coat colour
1050 TEJASWANI	1500	F	24-Mar-98	268	705	BANNERGHA	24-Mar-98	Birth	U 223 Normal-coat colour
1051 GAURI	1006	F	14-Apr-98	442	759	NANDANKAN MALAYSIA	14-Apr-98 02-Mar-99	Birth lf	827 White-coat colour
1052 UMA	1007	F	14-Apr-98	442	759	NANDANKAN	14-Apr-98 07-Apr-99	Birth Death	W 828 White-coat colour
1053 JAGDISH 98102058100	1008	M	14-Apr-98	442	759	NANDANKAN	14-Apr-98 06-Mar-10	Birth Death	W 829 White-coat colour
1054 PRAKASH	1009	M	14-Apr-98	442	759	NANDANKAN RANCHI	14-Apr-98 29-Nov-04 17-Jul-06	Birth Transfer Death	W 830 White-coat colour
1055 AARATHI 0006873A07	1010	F	21-Apr-98	859	848	NANDANKAN VISAKAPAT TIRUPATI	21-Apr-98 22-Sep-00 17-Dec-00 18-Aug-11	Birth Transfer Transfer Death	831 White-coat colour
1056 PRANATI	1011	F	21-Apr-98	859	848	NANDANKAN VISAKAPAT TIRUPATI	21-Apr-98 20-Sep-00 17-Dec-00 02-Dec-11	Birth Transfer Transfer Death	832 White-coat colour
1057	1012	F	21-Apr-98	859	848	NANDANKAN	21-Apr-98 06-May-98	Birth Death	833 White-coat colour
1058 SANTOSH	1013	M	21-Apr-98	859	848	NANDANKAN	21-Apr-98 11-Apr-99	Birth Death	W 834 White-coat colour
1059 RAJU-2	1501	M	30-Jun-98	UNK	UNK	CHATBIR Z LIBYA	30-Jun-98 22-Apr-01	Birth lf	U 331 Normal-coat colour

National Stud# House Name LocalID Transponder	Int. Std. #	Sex	Birth Date	Sire	Dam	Location	Date	Event	Old NSB # Remarks
1060	1502	M	30-Jun-98	UNK	UNK	CHATBIR Z	30-Jun-98	Birth Itf	U 332 Normal-coat colour
1061 PRIYA	1503	F	30-Jun-98	UNK	UNK	CHATBIR Z DELHI	30-Jun-98 17-Mar-01	Birth Transfer	U 333 Normal-coat colour
1062	1504	F	30-Jun-98	UNK	UNK	CHATBIR Z	30-Jun-98	Birth Itf	U 334 Normal-coat colour
1063 KRISHNA	1505	M	22-Jul-98	268	841	BANNERGHA	22-Jul-98	Birth	U 224 Normal-coat colour
1064 RADHA	1506	F	22-Jul-98	268	841	BANNERGHA	22-Jul-98 28-Jan-01	Birth Death	U 225 Normal-coat colour
1065 22	1507	?	22-Jul-98	268	841	BANNERGHA	22-Jul-98 22-Jul-98	Birth Death	U 226 Normal-coat colour
1066 23	1508	?	22-Jul-98	268	841	BANNERGHA	22-Jul-98 22-Jul-98	Birth Death	U 227 Normal-coat colour
1067	1509	?	22-Jul-98	268	841	BANNERGHA	22-Jul-98 22-Jul-98	Birth Death	U 228 Normal-coat colour
1068 RAJA	1014	M	26-Jul-98	761	776	BHILAI	26-Jul-98 05-May-11	Birth Death	W 835 White-coat colour
1069 RAJKUMAR	1015	M	26-Jul-98	761	776	BHILAI BOKARO	26-Jul-98 20-Jan-12	Birth Transfer	W 836 White-coat colour
1070 RANI	1016	F	26-Jul-98	761	776	BHILAI	26-Jul-98 09-May-09	Birth Death	W 837 White-coat colour
1071 RAJKUMARI	1017	F	26-Jul-98	761	776	BHILAI	26-Jul-98 23-Jul-12	Birth Death	W 838 White-coat colour
1072 25	1510	F	05-Aug-98	268	842	BANNERGHA	05-Aug-98 10-Sep-98	Birth Death	U 229 Normal-coat colour
1073 26	1511	F	05-Aug-98	268	842	BANNERGHA	05-Aug-98 14-Sep-98	Birth Death	U 230 Normal-coat colour
1074 27	1512	?	05-Aug-98	268	842	BANNERGHA	05-Aug-98 06-Aug-98	Birth Death	U 231 Normal-coat colour
1075 NARESH	999	M	~ 1991	WILD	WILD	INDIA VANVIHAR DELHI	~ 1998 09-Aug-98 24-Dec-05 12-Feb-12	Capture Transfer Transfer Death	724 Normal-coat colour
1076 BANDHABI	513	F	~ Aug 1990	WILD	WILD	INDIA NANDANKAN	~ 1990 13-Aug-98 05-Jul-00	Capture Transfer Death	631 Normal-coat colour
1077 BHEEMA	1513	M	26-Aug-98	597	679	BELLARY	26-Aug-98	Birth	U 241 Normal-coat colour
1078 28	1514	?	31-Aug-98	268	678	BANNERGHA	31-Aug-98 14-Sep-98	Birth Death	U 232 Normal-coat colour
1079 LAVA	1515	M	31-Aug-98	268	678	BANNERGHA	31-Aug-98	Birth	U 233 Normal-coat colour

National Stud# House Name LocalID Transponder	Int. Std. #	Sex	Birth Date	Sire	Dam	Location	Date	Event	Old NSB # Remarks
1080 KUSHA	1516	M	31-Aug-98	268	678	BANNERGHA	31-Aug-98 20-Nov-01	Birth Death	U 234 Normal- coat colour
1081 GANGA	1517	F	31-Aug-98	268	678	BANNERGHA	31-Aug-98	Birth	U 235 Normal- coat colour
1082 GONA/GAURI	1518	F	31-Aug-98	268	678	BANNERGHA	31-Aug-98	Birth	U 236 Normal- coat colour
1083 JAGAT	1019	M	15-Sep-98	513	435	NANDANKAN	15-Sep-98	Birth	W 840 White-coat colour
1084 SWAGAT	1020	M	15-Sep-98	513	435	NANDANKAN	15-Sep-98 08-Sep-03	Birth Death	W 841 White-coat colour
1087 MOHAN	1021	M	22-Sep-98	710	526	ITANAGAR	22-Sep-98 24-Sep-98	Birth Death	706 Normal- coat colour
1088 MOHINI	1022	F	22-Sep-98	710	526	ITANAGAR	22-Sep-98 18-Jan-99	Birth Death	707 Normal- coat colour
1090 GAURI	1023	F	22-Sep-98	710	526	ITANAGAR	22-Sep-98 11-May-17	Birth Death	708 Normal- coat colour
1091	1519	F	11-Oct-98	373	613	CALCUTTA	11-Oct-98 03-Mar-02	Birth Death	U 260 White-coat colour
1092 BADSHA	1520	M	11-Oct-98	373	613	CALCUTTA	11-Oct-98 12-Nov-05	Birth Death	WU 259 White-coat colour
1093	1024	M	18-Oct-98	757	847	NANDANKAN	18-Oct-98 29-Nov-98	Birth Death	842 White-coat colour
1094	1025	F	18-Oct-98	757	847	NANDANKAN	18-Oct-98 18-Oct-98	Birth Death	843 White-coat colour
1095	1026	M	18-Oct-98	757	847	NANDANKAN	18-Oct-98 02-Sep-99	Birth Death	844 White-coat colour
1096 PRIYA 0007150B59	1580	F	10-Nov-98	UNK	UNK	INDIA VANVIHAR	10-Nov-98 18-May-06	Birth Transfer	Normal- coat colour
1097 SUMITRA	1027	F	17-Nov-98	700	729	NANDANKAN VISAKAPAT	17-Nov-98 20-Sep-00	Birth lft	845 White-coat colour
1098	1028	F	17-Nov-98	700	729	NANDANKAN	17-Nov-98 08-Jul-99	Birth Death	846 White-coat colour
1099 SAUBHAGAYA	1029	M	17-Nov-98	700	729	NANDANKAN	17-Nov-98 02-Feb-00	Birth Death	W 847 White-coat colour
1100 SANDHYA	1030	F	24-Nov-98	680	913	SHIMOGA	24-Nov-98 24-Aug-99	Birth Death	848 Normal- coat colour
1101 SURYA	1031	M	24-Nov-98	680	913	SHIMOGA	24-Nov-98 19-May-04	Birth Death	849 Normal- coat colour
1102	1032	F	24-Nov-98	680	913	SHIMOGA	24-Nov-98	Birth	850 Normal- coat colour
1103 SHYAM	1186	M	~ 1980	WILD	WILD	MADHYA PR GWALIOR	~ 1999 ~ 1999	Capture lft	Normal- coat colour

National Stud# House Name LocalID Transponder	Int. Std. #	Sex	Birth Date	Sire	Dam	Location	Date	Event	Old NSB # Remarks
1104 GANGA	1187	F	~ 1980	WILD	WILD	MADHYA PR GWALIOR	~ 1999 ~ 1999	Capture lft	Normal- coat colour
1105	1523	F	27-Feb-99	268	706	BANNERGHA	27-Feb-99	Birth	U 237 Normal- coat colour
1106 POOJA	1524	F	27-Feb-99	268	706	BANNERGHA	27-Feb-99	Birth	U 238 Normal- coat colour
1107 RAJA	1525	M	27-Feb-99	268	706	BANNERGHA	27-Feb-99	Birth	U 239 Normal- coat colour
1108	1033	M	28-Feb-99	846	752	AHMEDABAD	28-Feb-99 31-Aug-99	Birth Death	714 White-coat colour
1109	1034	M	28-Feb-99	846	752	AHMEDABAD	28-Feb-99 31-Aug-99	Birth Death	715 White-coat colour
1110	1035	F	28-Feb-99	846	752	AHMEDABAD	28-Feb-99 18-Dec-99	Birth Death	716 White-coat colour
1111	903	M	14-Mar-99	530	730	RAJKOT	14-Mar-99 04-Feb-08	Birth Death	717 White-coat colour
1112 RIDHI	900	F	14-Mar-99	530	730	RAJKOT SURAT	14-Mar-99 10-Apr-02	Birth Transfer	718 White-coat colour
1113 SIDDHI 0006CC-186-B	901	F	14-Mar-99	530	730	RAJKOT VADODARA RAJKOT	14-Mar-99 15-Nov-02 18-Jul-10 13-Dec-11	Birth Transfer Transfer Death	719 White-coat colour
1114 NIDHI 00-01BD-3C18	902	F	14-Mar-99	530	730	RAJKOT JUNAGADH GANDHINAG	14-Mar-99 05-Dec-03 ~ 2009 10-Jul-16	Birth Transfer Transfer Death	720 White-coat colour
1115 RUPA-2	1526	F	05-Apr-99	412	820	CHATBIR Z LIBYA	05-Apr-99 22-Apr-01	Birth lft	Normal- coat colour
1116 GIDDU 000DE430	1527	M	05-Apr-99	412	UNK	CHATBIR Z AURANGABA	05-Apr-99 04-Dec-05 19-Jan-16	Birth Transfer Death	Normal- coat colour
1117	1036	?	09-May-99	423	939	AHMEDABAD	09-May-99 09-May-99	Birth Death	851 White-coat colour
1118	1037	?	09-May-99	423	939	AHMEDABAD	09-May-99 19-May-99	Birth Death	852 White-coat colour
1119	1038	?	09-May-99	423	939	AHMEDABAD	09-May-99 21-May-99	Birth Death	853 White-coat colour
1120 ROJA	1039	F	28-May-99	707	884	HYDERABAD	28-May-99	Birth	854 Normal- coat colour
1121 RANI 0006B8AE23	1040	F	28-May-99	707	884	HYDERABAD	28-May-99 24-Jan-08	Birth Death	855 Normal- coat colour
1122 RAJU	1041	M	28-May-99	707	884	HYDERABAD	28-May-99 15-Nov-99	Birth Death	856 Normal- coat colour
1123 PINTU	1521	M	????	UNK	UNK	LUDHIANA	????	Birth	Normal- coat colour
1124 RITA	1522	F	????	UNK	UNK	LUDHIANA	????	Birth	Normal- coat colour

National Stud# House Name LocalID Transponder	Int. Std. #	Sex	Birth Date	Sire	Dam	Location	Date	Event	Old NSB # Remarks
1126	1205	M	03-Jul-99	757	847	NANDANKAN	03-Jul-99 02-Sep-99	Birth Death	890 White-coat colour
1127 REBATI	1206	F	03-Jul-99	757	847	NANDANKAN	03-Jul-99	Birth	891 White-coat colour
1128 VISHNU	1042	M	05-Jul-99	650	755	BHILAI BOKARO	05-Jul-99 25-Aug-05	Birth Transfer	857 Normal- coat colour
1129 DURGA	1043	F	05-Jul-99	650	755	BHILAI	05-Jul-99 29-Dec-14	Birth Death	858 Normal- coat colour
1130 KRISHNA	1044	M	05-Jul-99	650	755	BHILAI	05-Jul-99 11-Dec-12	Birth Death	859 Normal- coat colour
1131	1045	F	28-Jul-99	401	554	ASSAM	28-Jul-99 28-Jul-99	Birth Death	860 White-coat colour
1132	1046	F	28-Jul-99	401	554	ASSAM	28-Jul-99 28-Jul-99	Birth Death	861 White-coat colour
1133	1047	M	28-Jul-99	401	554	ASSAM	28-Jul-99 28-Jul-99	Birth Death	862 White-coat colour
1134	1048	M	28-Jul-99	401	554	ASSAM	28-Jul-99 28-Jul-99	Birth Death	863 White-coat colour
1135 NIKHIL 10023	1050	M	08-Sep-99	510	567	HYDERABAD	08-Sep-99 23-Feb-17	Birth Death	892 White-coat colour
1136 VIKAS	1049	M	15-Sep-99	650	355	BHILAI	15-Sep-99 08-Sep-13	Birth Death	864 Normal- coat colour
1137 BHAGAT 98102058489	1018	M	15-Sep-99	513	435	NANDANKAN VANVIHAR	15-Sep-99 22-Apr-09 29-Mar-11	Birth Transfer Death	W 839 White-coat colour
1138 SAKI	1051	F	08-Oct-99	510	567	HYDERABAD	08-Oct-99 05-Oct-00	Birth Death	865 White-coat colour
1139 RAM	1052	M	08-Oct-99	761	776	BHILAI BOKARO	08-Oct-99 25-Aug-05 02-May-10	Birth Transfer Death	W 866 White-coat colour
1140 SHYAM	1053	M	08-Oct-99	761	776	BHILAI	08-Oct-99 10-Mar-00	Birth Death	W 867 White-coat colour
1141	1528	F	13-Nov-99	965	842	BORIVILLI	13-Nov-99 13-Nov-99	Birth Death	U 395 White-coat colour
1142	1529	M	13-Nov-99	965	842	BORIVILLI	13-Nov-99 13-Nov-99	Birth Death	U 396 White-coat colour
1143	1530	M	13-Nov-99	965	842	BORIVILLI	13-Nov-99 13-Nov-99	Birth Death	U 397 White-coat colour
1144	1531	F	13-Nov-99	965	842	BORIVILLI	13-Nov-99 13-Nov-99	Birth Death	U 398 White-coat colour
1145	1532	F	13-Nov-99	965	842	BORIVILLI	13-Nov-99 13-Nov-99	Birth Death	U 399 White-coat colour
1146 GOPAL		M	~ 1999	WILD	WILD	INDIA BANNERGHA	???? 18-Nov-14	Capture Transfer	Normal- coat colour

National Stud# House Name LocalID Transponder	Int. Std. #	Sex	Birth Date	Sire	Dam	Location	Date	Event	Old NSB # Remarks
1147 SHANTI 0006B71522	1533	F	22-Dec-99	803	767	TATA	22-Dec-99	Birth	U 335 Normal-coat colour
1148 BASANTI	1534	F	22-Dec-99	803	767	TATA RANCHI	22-Dec-99 11-Feb-03 12-Jul-06	Birth Transfer Death	U 336 Normal-coat colour
1149 RANI	1054	F	23-Dec-99	794	512	BOKARO	23-Dec-99	Birth	868 White-coat colour
1150 PINKI	1055	F	23-Dec-99	794	512	BOKARO	23-Dec-99	Birth	869 White-coat colour
1151 MOHINI	1056	F	23-Dec-99	794	512	BOKARO	23-Dec-99	Birth	870 White-coat colour
1152 JYOTI	1057	F	28-Dec-99	639	476	NANDANKAN	28-Dec-99 31-Oct-07	Birth Death	871 White-coat colour
1153 JYOTSHANA	1058	F	28-Dec-99	639	476	NANDANKAN RANCHI	28-Dec-99 15-Apr-02 09-Aug-06	Birth Transfer Death	872 White-coat colour
1154 KUSUM	1059	F	28-Dec-99	639	476	NANDANKAN	28-Dec-99 12-Aug-17	Birth Death	W 873 White-coat colour
1155 KISSAN 300	1060	M	28-Dec-99	639	476	NANDANKAN	28-Dec-99	Birth	W 874 White-coat colour
1156 SIDDHI		F	06-Mar-00	1116	1388	AURANGABA	06-Mar-00 26-Sep-11	Birth Death	Normal-coat colour
1157 SAMRUDDHI 00750151E		F	06-Mar-00	1116	1388	AURANGABA	06-Mar-00	Birth	Normal-coat colour
1158 SIDDHARTH 0074D5B17		M	06-Mar-00	1116	1388	AURANGABA	06-Mar-00	Birth	Normal-coat colour
1159 SHAMSHER 303	1061	M	25-Mar-00	859	848	NANDANKAN RANCHI	25-Mar-00 15-Apr-02 09-Jul-06	Birth Transfer Death	875 White-coat colour
1160 PRIYANKA	1062	F	25-Mar-00	859	848	NANDANKAN	25-Mar-00	Birth	876 White-coat colour
1161 LALITA 98102055586	1063	F	25-Mar-00	859	848	NANDANKAN VANVIHAR	25-Mar-00 19-Apr-09 19-Dec-13	Birth Transfer Death	W 877 White-coat colour
1162 LARA 302	1064	F	25-Mar-00	859	848	NANDANKAN	25-Mar-00 05-Jan-04	Birth Death	W 878 White-coat colour
1163 KRISHNA 28	1083	F	28-Mar-00	451	613	CALCUTTA	28-Mar-00	Birth	893 White-coat colour
1164 MEGHNA 29	1084	F	28-Mar-00	UNK	613	CALCUTTA	28-Mar-00	Birth	W 894 White-coat colour
1165	1535	F	29-Apr-00	927	934	LUCKNOW	29-Apr-00 03-May-00	Birth Death	880 Normal-coat colour
1166	1536	F	29-Apr-00	927	934	LUCKNOW	29-Apr-00 03-May-00	Birth Death	881 Normal-coat colour
1167	1537	F	29-Apr-00	927	934	LUCKNOW	29-Apr-00 09-Jun-00	Birth Death	Normal-coat colour

National Stud# House Name LocalID Transponder	Int. Std. #	Sex	Birth Date	Sire	Dam	Location	Date	Event	Old NSB # Remarks
1168 TULA 0006595F78	1538	M	30-May-00	UNK	UNK	CHATBIR Z RAJKOT	30-May-00 27-Mar-05 18-Jun-14	Birth Transfer Death	Normal- coat colour
1169 SHAMMI	1539	M	30-May-00	1026	1007	CHATBIR Z	30-May-00 02-May-07	Birth Death	Normal- coat colour
1170 PUMMY	1540	F	30-May-00	1026	1007	CHATBIR Z	30-May-00 20-Feb-11	Birth Death	Normal- coat colour
1171 GHANTI	1541	M	30-May-00	1026	1007	CHATBIR Z AURANGABA	30-May-00 04-Dec-05	Birth Transfer	Normal- coat colour
1172	1085	F	28-Jul-00	WILD	WILD	INDIA BORIVILLI	28-Jul-00 24-Oct-02	Capture Transfer	Normal- coat colour
1173 MANCHANDAN	1542	M	31-Jul-00	592	432	KOTA	31-Jul-00	Birth	U 400 Normal- coat colour
1174 RANA	1086	M	03-Aug-00	339	894	VISAKAPAT	03-Aug-00	Birth	896 Normal- coat colour
1175 SATHYA	1087	F	03-Aug-00	339	894	VISAKAPAT	03-Aug-00	Birth	897 Normal- coat colour
1176 RAMYA 0006B75070	1088	F	03-Aug-00	339	894	VISAKAPAT TIRUPATI	03-Aug-00 21-Dec-12	Birth Transfer	898 Normal- coat colour
1177	1543	F	03-Sep-00	965	842	BORIVILLI	03-Sep-00 03-Sep-00	Birth Death	U 401 White-coat colour
1178	1544	F	03-Sep-00	965	842	BORIVILLI	03-Sep-00 03-Sep-00	Birth Death	U 402 White-coat colour
1179	1545	F	03-Sep-00	965	842	BORIVILLI	03-Sep-00 03-Sep-00	Birth Death	U 403 White-coat colour
1180 SONY 10019	1067	F	07-Sep-00	883	860	HYDERABAD	07-Sep-00 17-Oct-16	Birth Death	899 White-coat colour
1181 ROGER 10020	1065	M	07-Sep-00	883	860	HYDERABAD	07-Sep-00 19-Oct-16	Birth Death	900 White-coat colour
1182 NOEL	1066	M	07-Sep-00	883	860	HYDERABAD	07-Sep-00 08-Apr-02	Birth Death	901 White-coat colour
1183 KARTHIK	1546	M	04-Oct-00	972	841	BANNERGHA	04-Oct-00	Birth	Normal- coat colour
1184 MANASA	1547	F	04-Oct-00	972	841	BANNERGHA	04-Oct-00	Birth	Normal- coat colour
1185 MISHU	1548	F	15-Nov-00	1008	1024	CHATBIR Z LUDHIANA	15-Nov-00 20-Jan-05	Birth Transfer	Normal- coat colour
1186 PRERNA	1549	F	15-Nov-00	1008	1024	CHATBIR Z	15-Nov-00 18-Sep-06	Birth Death	Normal- coat colour
1187 ELACHI	1550	F	15-Nov-00	1008	1024	CHATBIR Z LUDHIANA CHATBIR Z LUDHIANA	15-Nov-00 20-Jan-05 30-Jan-07 28-May-08	Birth Transfer Transfer Transfer	Normal- coat colour
1188 HIMANSHU	1551	M	15-Nov-00	1008	1024	CHATBIR Z	15-Nov-00 26-Aug-05	Birth Death	Normal- coat colour
1190 JAGIR 00-0643-5CEQ	1089	M	26-Nov-00	965	987	BORIVILLI PUNE	26-Nov-00 20-Dec-06 08-Apr-17	Birth Transfer Death	W 902 White-coat colour
1191 Priyadarshi 000-63D-E55E	1090	F	26-Nov-00	965	987	BORIVILLI PUNE	26-Nov-00 20-Dec-06	Birth Transfer	W 903 White-coat colour

National Stud# House Name LocalID Transponder	Int. Std. #	Sex	Birth Date	Sire	Dam	Location	Date	Event	Old NSB # Remarks
1192 RAJIYA	1091	F	26-Nov-00	965	987	BORIVILLI	26-Nov-00	Birth	W 904 White-coat colour
1193 DYNA	1092	F	26-Nov-00	965	987	BORIVILLI	26-Nov-00 11-Sep-01	Birth Death	W 905 White-coat colour
1194 SARALA	1552	F	13-Dec-00	990	991	SHIMOGA	13-Dec-00 13-Aug-08	Birth Death	U 362 Normal- coat colour
1195 GOVARDHANA	1553	M	13-Dec-00	990	991	SHIMOGA ASSAM	13-Dec-00 19-Feb-05 04-Jan-09	Birth Transfer Death	U 363 Normal- coat colour
1196	1556	F	03-Jan-01	965	842	BORIVILLI	03-Jan-01 10-Jan-01	Birth Death	U 406 White-coat colour
1197	1557	F	03-Jan-01	965	842	BORIVILLI	03-Jan-01 22-Jan-01	Birth Death	U 407 White-coat colour
1198	1558	F	03-Jan-01	965	842	BORIVILLI	03-Jan-01 29-Jan-01	Birth Death	U 408 White-coat colour
1199	1554	M	03-Jan-01	965	842	BORIVILLI	03-Jan-01 07-Feb-01	Birth Death	WU 404 White-coat colour
1200	1555	F	03-Jan-01	965	842	BORIVILLI	03-Jan-01 06-Jan-01	Birth Death	WU 405 White-coat colour
1201 SOBHA	1093	F	11-Feb-01	761	776	BHILAI	11-Feb-01 17-Feb-02	Birth Death	W 928 White-coat colour
1202 SUNDER	1094	M	11-Feb-01	761	776	BHILAI	11-Feb-01 02-Aug-16	Birth Death	W 929 White-coat colour
1203 KAMLA	1095	F	11-Feb-01	761	776	BHILAI	11-Feb-01 10-Apr-16	Birth Death	W 930 White-coat colour
1204 VIMLA	1096	F	11-Feb-01	761	776	BHILAI BOKARO	11-Feb-01 20-Jan-12	Birth Transfer	W 931 White-coat colour
1205	1097	F	31-Mar-01	382	839	MADRAS	31-Mar-01 31-Mar-01	Birth Death	906 White-coat colour
1206	1098	F	31-Mar-01	382	839	MADRAS	31-Mar-01 31-Mar-01	Birth Death	907 White-coat colour
1207	1099	F	31-Mar-01	382	839	MADRAS	31-Mar-01 31-Mar-01	Birth Death	908 White-coat colour
1208	1559	M	25-May-01	UNK	808	DELHI	25-May-01	Birth	Normal- coat colour
1209 KARAN	1560	M	25-May-01	UNK	808	DELHI	25-May-01 05-Aug-04	Birth Death	U 409 Normal- coat colour
1210 ARJUN	1561	M	25-May-01	UNK	808	DELHI	25-May-01 30-May-01	Birth Death	U 410 Normal- coat colour
1211	1562	F	25-May-01	UNK	808	DELHI	25-May-01 25-May-01	Birth Death	U 411 Normal- coat colour
1212 TEESTA 30	1100	F	18-Jun-01	451	613	CALCUTTA	18-Jun-01	Birth	909 White-coat colour

National Stud# House Name LocalID Transponder	Int. Std. #	Sex	Birth Date	Sire	Dam	Location	Date	Event	Old NSB # Remarks
1213 SHIRISH 0006B72939	1101	M	19-Jun-01	911	950	HYDERABAD VISAKAPAT	19-Jun-01 10-Jul-02	Birth Transfer	910 White-coat colour
1214 MEGHNA	1102	F	19-Jun-01	911	950	HYDERABAD	19-Jun-01 18-Nov-01	Birth Death	911 White-coat colour
1215	1103	F	22-Jun-01	910	1055	TIRUPATI	22-Jun-01 25-Jun-01	Birth Death	912 White-coat colour
1216	1104	M	22-Jun-01	910	1055	TIRUPATI	22-Jun-01 02-Jul-01	Birth Death	913 White-coat colour
1217 ARYAN	1105	M	03-Jul-01	951	940	LUCKNOW	03-Jul-01 24-Nov-17	Birth Death	W 914 White-coat colour
1218 SWETA	1106	F	03-Jul-01	951	940	LUCKNOW	03-Jul-01	Birth	W 915 White-coat colour
1219 JAMUNA 260021	1107	F	05-Aug-01	886	744	DELHI GWALIOR	05-Aug-01 08-Feb-11	Birth Transfer	W 917 White-coat colour
1220 SARASWATI	1108	F	05-Aug-01	886	744	DELHI PATNA	05-Aug-01 23-Mar-05	Birth Transfer	W 918 White-coat colour
1221 TRIVENI	1109	F	05-Aug-01	886	744	DELHI PATNA	05-Aug-01 26-Mar-05 01-Jul-11	Birth Transfer Death	W 919 White-coat colour
1222 GANGA	1110	F	05-Aug-01	886	744	DELHI JUNAGADH	05-Aug-01 21-Sep-04	Birth Transfer	W 996 White-coat colour
1223	1111	M	18-Sep-01	382	839	MADRAS	18-Sep-01 25-Sep-01	Birth Death	920 White-coat colour
1224	1112	M	18-Sep-01	382	839	MADRAS	18-Sep-01 29-Sep-01	Birth Death	921 White-coat colour
1225	1113	F	18-Sep-01	382	839	MADRAS	18-Sep-01 25-Sep-01	Birth Death	922 White-coat colour
1226 YAMUNA 10058		F	26-Sep-01	UNK	UNK	DELHI JUNAGADH	26-Sep-01 26-Sep-04	Birth Transfer	Normal- coat colour
1227 SHREYA	1563	F	08-Oct-01	UNK	992	SHIMOGA	08-Oct-01	Birth	U 411 Normal- coat colour
1228 JANAKI 0006B75E36	1114	F	02-Nov-01	UNK	882	VISAKAPAT	02-Nov-01	Birth	923 Normal- coat colour
1229 RAJANI	1115	F	02-Nov-01	UNK	882	VISAKAPAT	02-Nov-01	Birth	924 Normal- coat colour
1230 SEETHA 0006B76960	1564	F	02-Nov-01	UNK	882	VISAKAPAT	02-Nov-01	Birth	U 412 Normal- coat colour
1231	1116	M	21-Nov-01	910	1055	TIRUPATI	21-Nov-01 20-Jun-02	Birth Death	925 White-coat colour
1232	1117	F	21-Nov-01	910	1055	TIRUPATI	21-Nov-01 09-Jul-02	Birth Death	926 White-coat colour

National Stud# House Name LocalID Transponder	Int. Std. #	Sex	Birth Date	Sire	Dam	Location	Date	Event	Old NSB # Remarks
1233	1118	F	21-Nov-01	910	1055	TIRUPATI	21-Nov-01 19-Jul-02	Birth Death	927 White-coat colour
1234 315	1068	M	09-Dec-01	757	847	NANDANKAN	09-Dec-01 08-Mar-02	Birth Death	935 White-coat colour
1235 316	1069	M	09-Dec-01	757	847	NANDANKAN	09-Dec-01 08-Jun-02	Birth Death	936 White-coat colour
1236 AJIT 317	1070	M	09-Dec-01	757	847	NANDANKAN	09-Dec-01 16-Nov-02	Birth Death	937 White-coat colour
1237 ALOK 318	1071	M	09-Dec-01	757	847	NANDANKAN	09-Dec-01 06-Feb-03	Birth Death	938 White-coat colour
1238	1072	?	09-Dec-01	757	847	NANDANKAN	09-Dec-01 09-Dec-01	Birth Death	939 White-coat colour
1239 DIANA	1119	F	13-Dec-01	625	567	HYDERABAD	13-Dec-01 16-Aug-02	Birth Death	932 White-coat colour
1240 APARNA 10021	1120	F	13-Dec-01	625	567	HYDERABAD	13-Dec-01	Birth	934 White-coat colour
1241 HASINA 0006B72ED6 M19W02	1121	F	13-Dec-01	625	567	HYDERABAD TIRUPATI	13-Dec-01 06-Mar-05	Birth Transfer	W 934 White-coat colour
1242	1566	F	05-Jan-02	719	825	MYSORE	05-Jan-02	Birth	U 413 White-coat colour
1243	1567	M	05-Jan-02	719	825	MYSORE	05-Jan-02	Birth	U 414 White-coat colour
1244 MOHANA	1568	M	08-Jan-02	972	677	BANNERGHA	08-Jan-02	Birth	Normal- coat colour
1245 SINDHU	1569	F	08-Jan-02	972	677	BANNERGHA	08-Jan-02	Birth	Normal- coat colour
1246 MENAKA	1570	F	08-Jan-02	972	677	BANNERGHA	08-Jan-02	Birth	Normal- coat colour
1247	1571	F	08-Jan-02	972	677	BANNERGHA	08-Jan-02	Birth	Normal- coat colour
1248 APPAIAH	1572	M	08-Jan-02	972	677	BANNERGHA CHATBIR Z	08-Jan-02 16-Mar-11	Birth Transfer	Normal- coat colour
1249 LAVA	1573	M	19-Feb-02	990	835	SHIMOGA	19-Feb-02	Birth	U 415 Normal- coat colour
1250 KUSHA	1574	M	19-Feb-02	990	835	SHIMOGA	19-Feb-02	Birth	U 416 Normal- coat colour
1251 DIVYA	1575	F	19-Feb-02	990	835	SHIMOGA ASSAM	19-Feb-02 19-Feb-05 02-Jul-14	Birth Transfer Death	U 417 Normal- coat colour
1252	1576	M	19-Feb-02	UNK	835	SHIMOGA	19-Feb-02 22-Jun-02	Birth Death	U 418 Normal- coat colour
1253	1577	F	19-Feb-02	UNK	835	SHIMOGA	19-Feb-02 26-Apr-02	Birth Death	U 419 Normal- coat colour
1254 PULAKESHI	1188	M	20-Feb-02	680	681	SHIMOGA MANGALORE	20-Feb-02 23-Nov-06	Birth Transfer	Normal- coat colour

National Stud# House Name LocalID Transponder	Int. Std. #	Sex	Birth Date	Sire	Dam	Location	Date	Event	Old NSB # Remarks
1255 HOYSALA	1189	M	20-Feb-02	680	681	SHIMOGA	20-Feb-02 26-Apr-05	Birth Death	Normal- coat colour
1256 VIKRAM 9.81098E+1205 100001	1190	M	20-Feb-02	680	681	SHIMOGA MANGALORE	20-Feb-02 25-Nov-03	Birth Transfer	Normal- coat colour
1257 VANAMALA	1191	F	20-Feb-02	680	681	SHIMOGA MANGALORE	20-Feb-02 23-Nov-06	Birth Transfer	Normal- coat colour
1258	1582	F	20-Feb-02	UNK	681	SHIMOGA	20-Feb-02 23-Apr-02	Birth Death	U 424 Normal- coat colour
1259	1122	M	26-Mar-02	979	907	KANPUR	26-Mar-02 02-Apr-02	Birth Death	940 White-coat colour
1260 NAMRATHA	1583	M	18-Apr-02	597	946	BANNERGHA	18-Apr-02	Birth	Normal- coat colour
1261 RASHMI	1584	F	18-Apr-02	597	946	BANNERGHA	18-Apr-02	Birth	Normal- coat colour
1262 ROOPA	1585	F	18-Apr-02	597	946	BANNERGHA	18-Apr-02	Birth	Normal- coat colour
1263 TIPPU	1586	M	18-Apr-02	597	946	BANNERGHA	18-Apr-02	Birth	Normal- coat colour
1264 DRAVID	1587	M	19-Apr-02	623	706	BANNERGHA	19-Apr-02	Birth	White-coat colour
1265 BRADIS	1588	M	19-Apr-02	623	706	BANNERGHA	19-Apr-02	Birth	White-coat colour
1266 TANU	1589	F	19-Apr-02	623	706	BANNERGHA	19-Apr-02	Birth	White-coat colour
1267 GHANCI RANI	1590	F	19-Apr-02	623	706	BANNERGHA	19-Apr-02	Birth	White-coat colour
1268 MASTI M00184	1123	M	~ 1997	WILD	WILD	KARNATAKA MYSORE BANNERGHA	~ Jun 2002 07-Jun-02 11-Apr-05	Capture Transfer Transfer	889 Normal- coat colour
1269 PARAS	1591	M	23-Jun-02	1123	1124	LUDHIANA CHATBIR Z	23-Jun-02 28-May-08	Birth Transfer	Normal- coat colour
1270 KALPANA CHAWLA	1592	F	24-Jul-02	623	706	BANNERGHA	24-Jul-02	Birth	White-coat colour
1271 TENDULKAR	1593	M	24-Jul-02	623	706	BANNERGHA	24-Jul-02	Birth	White-coat colour
1272	1594	M	02-Aug-02	831	826	MYSORE	02-Aug-02 02-Aug-02	Birth Death	U 425 White-coat colour
1273 AGASTHYA M00084 0006B757FB	1595	M	06-Aug-02	719	825	MYSORE	06-Aug-02	Birth	U 426 White-coat colour
1274 ANANYA M00182 0006B71710	1596	F	06-Aug-02	719	825	MYSORE AHMEDABAD	06-Aug-02 12-Aug-08	Birth Transfer	U 427 White-coat colour
1275 AMULYA M00077 0006B7E207	1597	M	06-Aug-02	719	825	MYSORE	06-Aug-02	Birth	U 428 White-coat colour
1276 ROSHAN 98102058095	1125	M	05-Sep-02	639	476	NANDANKAN	05-Sep-02	Birth	943 White-coat colour
1277 RAKHI 98102057244	1126	F	05-Sep-02	639	476	NANDANKAN	05-Sep-02 14-Oct-13	Birth Death	944 White-coat colour

National Stud# House Name LocalID Transponder	Int. Std. #	Sex	Birth Date	Sire	Dam	Location	Date	Event	Old NSB # Remarks
1278 320	1124	M	05-Sep-02	639	476	NANDANKAN	05-Sep-02 24-Apr-03	Birth Death	W 942 White-coat colour
1279	1598	M	16-Sep-02	UNK	991	SHIMOGA	16-Sep-02 11-Nov-02	Birth Death	U 429 Normal- coat colour
1280 VEERBHADRA	1599	M	16-Sep-02	UNK	991	SHIMOGA	16-Sep-02 08-Dec-05	Birth Death	U 430 Normal- coat colour
1281 VARADHA 9.81098E+1206	1600	F	16-Sep-02	680	991	SHIMOGA MANGALORE	16-Sep-02 23-Nov-03	Birth Transfer	U 431 Normal- coat colour
1282 DODA 00 061F 5B12	1073	M	~ Jul 2002	WILD	WILD	INDIA PUNE	~ Sep 2002 25-Sep-02 30-Dec-07	Capture Transfer Death	941 Normal- coat colour
1283	1127	M	16-Oct-02	979	907	KANPUR	16-Oct-02 16-Oct-02	Birth Death	945 White-coat colour
1284	1128	F	16-Oct-02	979	907	KANPUR	16-Oct-02 16-Oct-02	Birth Death	946 White-coat colour
1285	1129	F	16-Oct-02	979	907	KANPUR	16-Oct-02 16-Oct-02	Birth Death	947 White-coat colour
1286	1130	F	16-Oct-02	979	907	KANPUR	16-Oct-02 16-Oct-02	Birth Death	948 White-coat colour
1287	1131	M	29-Oct-02	965	987	BORIVILLI	29-Oct-02 29-Oct-02	Birth Death	949 White-coat colour
1288	1132	M	29-Oct-02	965	987	BORIVILLI	29-Oct-02 29-Oct-02	Birth Death	950 White-coat colour
1289	1133	F	29-Oct-02	965	987	BORIVILLI	29-Oct-02 31-Oct-02	Birth Death	951 White-coat colour
1290 RANDEER 0006B73B65 M19W01	1134	M	19-Nov-02	911	950	HYDERABAD TIRUPATI	19-Nov-02 06-Mar-05	Birth Transfer	W 952 White-coat colour
1291 BASANI 10007	1158	F	~ Oct 2002	WILD	WILD	MADHYA PR VANVIHAR BORIVILLI	~30 Jan 2003 30-Jan-03 07-Apr-06 17-Apr-16	Capture Transfer Transfer Death	Normal- coat colour
1292 GUTAM	1159	M	~ Oct 2002	WILD	WILD	MADHYA PR VANVIHAR	~30 Jan 2003 31-Jan-03 06-Dec-07	Capture Transfer Death	Normal- coat colour
1293 CHANDU	1135	F	01-Feb-03	707	894	VISAKAPAT	01-Feb-03	Birth	953 Normal- coat colour
1294 VIJAY 100163	1136	M	01-Feb-03	707	894	VISAKAPAT MADRAS	01-Feb-03 10-Aug-07	Birth Transfer	954 Normal- coat colour
1295 RAMBO	1137	M	01-Feb-03	707	894	VISAKAPAT	01-Feb-03	Birth	955 Normal- coat colour
1296 BALU 0006B785A1	1192	M	01-Feb-03	707	894	VISAKAPAT	01-Feb-03	Birth	Normal- coat colour

National Stud# House Name LocalID Transponder	Int. Std. #	Sex	Birth Date	Sire	Dam	Location	Date	Event	Old NSB # Remarks
1297 SUGREEVA	1601	M	16-Feb-03	680	992	SHIMOGA RANCHI	16-Feb-03 21-Jul-09 27-Nov-15	Birth Transfer Death	Normal- coat colour
1298 DURGA	1602	F	16-Feb-03	680	992	SHIMOGA RANCHI	16-Feb-03 21-Jul-09 14-Dec-14	Birth Transfer Death	Normal- coat colour
1299 VALI	1603	M	16-Feb-03	680	992	SHIMOGA	16-Feb-03	Birth	Normal- coat colour
1300 HANUMAN	1604	F	16-Feb-03	680	992	SHIMOGA	16-Feb-03	Birth	Normal- coat colour
1301 CHILLI	1605	F	11-Apr-03	UNK	UNK	CHATBIR Z SEPAHIJAL	11-Apr-03 25-Dec-06 05-May-16	Birth Transfer Death	Normal- coat colour
1302 CHORNI	1606	F	11-Apr-03	1169	1185	CHATBIR Z LUDHIANA CHATBIR Z	11-Apr-03 20-Jan-05 28-May-08	Birth Transfer Transfer	Normal- coat colour
1303 14	1607	M	11-May-03	538	1001	TRIVANDRU TRICHUR	11-May-03 21-Jun-09	Birth Transfer	Normal- coat colour
1304 RAVI	1608	M	11-May-03	538	1001	TRIVANDRU	11-May-03	Birth	U 432 Normal- coat colour
1305 RAHUL	1609	M	11-May-03	538	1001	TRIVANDRU	11-May-03	Birth	U 433 Normal- coat colour
1306 RESMY	1610	F	11-May-03	538	1001	TRIVANDRU	11-May-03	Birth	U 434 Normal- coat colour
1307 CHOTA	1611	M	17-May-03	1169	1186	CHATBIR Z	17-May-03 17-Nov-04	Birth Death	Normal- coat colour
1308 CHOTI	1612	F	17-May-03	1169	1186	CHATBIR Z	17-May-03 27-Jul-04	Birth Death	Normal- coat colour
1309 CHOTU 0006CC3AID	1613	M	17-May-03	1169	1186	CHATBIR Z AURANGABA INDORE	17-May-03 04-Dec-05 07-Dec-05 24-Aug-11	Birth Transfer Transfer Death	Normal- coat colour
1310 DEEPU	1614	M	30-May-03	UNK	UNK	CHATBIR Z SEPAHIJAL	30-May-03 25-Dec-06 04-May-16	Birth Transfer Death	Normal- coat colour
1311 DARA	1615	M	30-May-03	1026	818	CHATBIR Z	30-May-03	Birth	Normal- coat colour
1312 DAMAN	1616	F	30-May-03	1026	818	CHATBIR Z	30-May-03 29-Jun-04	Birth Death	Normal- coat colour
1313 DEEYA	1617	F	30-May-03	1026	1024	CHATBIR Z	30-May-03 20-Sep-06	Birth Death	Normal- coat colour
1314 DIDAR	1618	M	30-May-03	1026	818	CHATBIR Z	30-May-03 09-Dec-04	Birth Death	Normal- coat colour
1315 DEEPAK	1619	M	30-May-03	1026	1024	CHATBIR Z LUDHIANA	30-May-03 18-Jan-05	Birth Transfer	Normal- coat colour
1316 DIKSHAK	1621	M	30-May-03	1026	818	CHATBIR Z	30-May-03 13-Sep-04	Birth Death	Normal- coat colour
1317 BAJIRAO	1207	M	20-Aug-03	965	987	BORIVILLI	20-Aug-03	Birth	White-coat colour
1318 ARYA	1208	M	20-Aug-03	965	987	BORIVILLI	20-Aug-03	Birth	White-coat colour
1319 MASTANI	1209	F	20-Aug-03	965	987	BORIVILLI	20-Aug-03	Birth	White-coat colour
1320 SHWETA	1160	F	20-Sep-03	864	640	VANVIHAR	20-Sep-03 21-Jun-10	Birth Death	White-coat colour
1321 PALASH	1210	M	20-Sep-03	864	640	VANVIHAR BORIVILLI	20-Sep-03 07-Apr-06	Birth Transfer	White-coat colour

National Stud# House Name LocalID Transponder	Int. Std. #	Sex	Birth Date	Sire	Dam	Location	Date	Event	Old NSB # Remarks
1322 POLO RBT-14	1076	M	01-Jan-04	UNK	1090	ITANAGAR	01-Jan-04 10-Mar-10	Birth Death	Normal- coat colour
1323 TAKAR RBT12	1074	M	01-Jan-04	UNK	1090	ITANAGAR	01-Jan-04	Birth	Normal- coat colour
1324 DONYI RBT-13	1075	M	01-Jan-04	UNK	1090	ITANAGAR	01-Jan-04 20-Feb-06	Birth Death	Normal- coat colour
1325 SAURABHA		M	18-Jan-04	1042	1044	AURANGABA CHATBIR Z	18-Jan-04 07-Dec-05	Birth Transfer	White-coat colour
1326 KAIF 0006CD2040		M	18-Jan-04	1042	1044	AURANGABA PUNE	18-Jan-04 11-Apr-15 09-Jun-17	Birth Transfer Death	White-coat colour
1327 SACHIN		M	18-Jan-04	1042	1044	AURANGABA	18-Jan-04	Birth	White-coat colour
1328 MANDIRA		F	18-Jan-04	1042	1044	AURANGABA	18-Jan-04	Birth	White-coat colour
1332 TANAJI 000-6A27-D63	1622	M	01-Feb-04	771	993	PUNE	01-Feb-04	Birth	Normal- coat colour
1333 NANDINI 000-6A2A-2E2	1623	F	01-Feb-04	771	993	PUNE	01-Feb-04	Birth	Normal- coat colour
1334 DAMINI 000-6A2A-D56	1624	F	01-Feb-04	771	993	PUNE UDAIPUR	01-Feb-04 07-Feb-15	Birth Transfer	Normal- coat colour
1335 ANIRUDHA	1161	M	~ 1996	WILD	WILD	INDIA ASSAM	~ 7 Mar 2004 07-Mar-04 22-Nov-10	Capture Transfer Death	Normal- coat colour
1336 MOGALI 00-01BD-4039	1138	M	28-Mar-04	474	978	JUNAGADH	28-Mar-04	Birth	White-coat colour
1337 ABHAY 00-01BD-4039	1139	M	28-Mar-04	474	978	JUNAGADH KANPUR	28-Mar-04 02-Jan-10	Birth Transfer	White-coat colour
1338 SRUSHTI 00-01BC-8AD3	1140	F	28-Mar-04	474	978	JUNAGADH	28-Mar-04	Birth	White-coat colour
1339 KALPANA 10022		F	11-Apr-04	625	567	HYDERABAD	11-Apr-04	Birth	White-coat colour
1340	1212	M	24-Apr-04	859	848	NANDANKAN	24-Apr-04 14-Aug-05	Birth Death	White-coat colour
1341 SISIRA	1213	M	24-Apr-04	859	848	NANDANKAN LUCKNOW	24-Apr-04 03-Oct-07	Birth Transfer	White-coat colour
1342 SONIA	1214	F	24-Apr-04	859	848	NANDANKAN	24-Apr-04 03-Apr-08	Birth Death	White-coat colour
1343	1215	F	24-Apr-04	859	848	NANDANKAN	24-Apr-04 13-May-04	Birth Death	White-coat colour
1344 RANI	1163	F	~ 1999	WILD	WILD	UTTARANCH NAINITAL DELHI	~27 Apr 2004 27-Apr-04 15-Mar-05	Capture Transfer Transfer	Normal- coat colour
1345 KIRAN	1625	M	12-Jul-04	538	1001	TRIVANDRU	12-Jul-04	Birth	Normal- coat colour
1346 KARTHIKA	1626	F	12-Jul-04	538	1001	TRIVANDRU	12-Jul-04	Birth	Normal- coat colour
1347 ANU	1627	F	23-Jul-04	704	1184	BANNERGHA	23-Jul-04	Birth	Normal- coat colour
1348	1628	F	23-Jul-04	704	1184	BANNERGHA	23-Jul-04 18-Oct-04	Birth Death	Normal- coat colour

National Stud# House Name LocalID Transponder	Int. Std. #	Sex	Birth Date	Sire	Dam	Location	Date	Event	Old NSB # Remarks
1349 IPSITA	1216	F	24-Jul-04	626	759	NANDANKAN LUCKNOW	24-Jul-04 03-Oct-07	Birth Transfer	White-coat colour
1350 RISHI	1217	M	01-Aug-04	757	847	NANDANKAN CALCUTTA	01-Aug-04 19-Feb-16	Birth Transfer	White-coat colour
1351 SITESH	1218	M	01-Aug-04	757	847	NANDANKAN ASSAM	01-Aug-04 25-Aug-11 21-Sep-15	Birth Transfer Death	White-coat colour
1352 PRACHI	1219	F	01-Aug-04	757	847	NANDANKAN CHATBIR Z	01-Aug-04 11-Mar-12	Birth Transfer	White-coat colour
1353 ISHU	1220	F	13-Aug-04	886	744	DELHI VANVIHAR	13-Aug-04 21-Nov-05 12-Oct-07	Birth Transfer Death	White-coat colour
1354 KEERTHI 230026 M20W15	1629	F	26-Aug-04	510	950	HYDERABAD TIRUPATI	26-Aug-04 08-Aug-11	Birth Transfer	White-coat colour
1355 KUNAL	1630	M	26-Aug-04	510	950	HYDERABAD	26-Aug-04	Birth	White-coat colour
1356 GAURI 7154446	1581	F	28-Aug-04	UNK	UNK	JAIPUR VANVIHAR	28-Aug-04 21-Mar-13	Birth Transfer	Normal- coat colour
1357 KUMARI	1631	F	28-Aug-04	510	950	HYDERABAD VISAKAPAT	28-Aug-04 23-Sep-07	Birth Transfer	White-coat colour
1358 AMAR 00-0026-8EBF	1141	M	04-Oct-04	474	980	JUNAGADH	04-Oct-04	Birth	White-coat colour
1359 PRAKRUTI 00-01BD-8932	1142	F	04-Oct-04	474	980	JUNAGADH	04-Oct-04	Birth	White-coat colour
1360 MAHASHWETA 00-01BC-91AD	1143	F	12-Dec-04	905	1114	JUNAGADH	12-Dec-04 23-Jul-14	Birth Death	White-coat colour
1361 SWETA 00-01BD-35BB	1144	F	12-Dec-04	905	1114	JUNAGADH	12-Dec-04 23-Jul-14	Birth Death	White-coat colour
1362 TRUSHA 00-01BD-48F8	1145	F	12-Dec-04	905	1114	JUNAGADH KANPUR	12-Dec-04 02-Jan-10	Birth Transfer	White-coat colour
1363	1146	F	12-Dec-04	905	1114	JUNAGADH	12-Dec-04 13-Dec-04	Birth Death	White-coat colour
1364 XING XING	1632	F	16-Jan-05	764	809	DELHI	16-Jan-05 26-Apr-14	Birth Death	Normal- coat colour
1365	1633	M	16-Jan-05	764	809	DELHI	16-Jan-05 18-Jan-05	Birth Death	Normal- coat colour
1366	1634	M	16-Jan-05	764	809	DELHI	16-Jan-05 18-Jan-05	Birth Death	Normal- coat colour
1367	1638	M	16-Jan-05	764	809	DELHI	16-Jan-05 16-Jan-05	Birth Death	Normal- coat colour
1368	1635	M	16-Jan-05	764	809	DELHI	16-Jan-05 16-Jan-05	Birth Death	Normal- coat colour
1369	1636	M	16-Jan-05	764	809	DELHI	16-Jan-05 16-Jan-05	Birth Death	Normal- coat colour
1370	1637	M	16-Jan-05	764	809	DELHI	16-Jan-05 16-Jan-05	Birth Death	Normal- coat colour
1371 BHISMA 100181	1221	M	14-Feb-05	886	1219	DELHI MADRAS	14-Feb-05 30-Sep-06	Birth Transfer	White-coat colour
1372 SITA 260025	1222	F	14-Feb-05	886	1219	DELHI CHATBIR Z	14-Feb-05 12-May-12	Birth lf	White-coat colour

National Stud# House Name LocalID Transponder	Int. Std. #	Sex	Birth Date	Sire	Dam	Location	Date	Event	Old NSB # Remarks
1374 RASHMI	1224	F	01-Mar-05	965	1192	BORIVILLI VANVIHAR	01-Mar-05 11-Apr-06 14-Mar-08	Birth Transfer Death	White-coat colour
1375	1640	F	04-Mar-05	997	1163	CALCUTTA	04-Mar-05	Birth	White-coat colour
1376 PRATHAP M00181	1461	M	10-Apr-05	719	825	MYSORE AHMEDABAD	10-Apr-05 12-Aug-08	Birth Transfer	White-coat colour
1377 PRASHANTH M00183		M	10-Apr-05	719	825	MYSORE	10-Apr-05 26-Feb-06	Birth Death	White-coat colour
1378 MANYA M00076 000-6B74-A9D	1643	F	10-Apr-05	719	825	MYSORE	10-Apr-05	Birth	White-coat colour
1379 KARAN	1225	M	21-Apr-05	965	1191	BORIVILLI VANVIHAR	21-Apr-05 11-Apr-06 15-Oct-06	Birth Transfer Death	White-coat colour
1380 ANU 260027 100182	1162	F	20-Jun-05	669	1221	DELHI MADRAS	20-Jun-05 30-Sep-06	Birth Transfer	White-coat colour
1381 KHUSHI	1226	F	26-Jun-05	669	1221	DELHI	26-Jun-05 13-Jun-13	Birth Death	White-coat colour
1382 RAGHAB 0006B7640F	1646	M	05-Nov-05	1335	991	ASSAM TATA	05-Nov-05 24-Mar-10	Birth Transfer	Normal- coat colour
1383 RAGINI 0006B75236	1647	F	05-Nov-05	1335	991	ASSAM RAIPUR	05-Nov-05 01-Sep-12	Birth Transfer	Normal- coat colour
1384 BIPIN	1648	M	05-Nov-05	1335	991	ASSAM	05-Nov-05	Birth	Normal- coat colour
1385 LAXAMANA	1649	M	23-Nov-05	680	835	SHIMOGA	23-Nov-05 05-Jul-08	Birth Death	Normal- coat colour
1386 RAM	1650	M	23-Nov-05	680	835	SHIMOGA	23-Nov-05	Birth	Normal- coat colour
1387 BHARATHA	1651	M	23-Nov-05	680	835	SHIMOGA	23-Nov-05	Birth	Normal- coat colour
1388 DEEPTI	1620	F	????	1026	1024	CHATBIR Z AURANGABA	???? 04-Dec-05 26-May-16	Birth Transfer Death	Normal- coat colour
1389 SWET	1147	M	28-Feb-06	905	1222	JUNAGADH	28-Feb-06	Birth	White-coat colour
1390 DHAVAL 0001CDDA9F	1148	M	28-Feb-06	905	1222	JUNAGADH RAJKOT	28-Feb-06 25-Jun-15	Birth Transfer	White-coat colour
1391 PREET 00-0-202-8105	1149	M	28-Feb-06	905	1222	JUNAGADH VADODARA	28-Feb-06 06-Mar-10	Birth Transfer	White-coat colour
1392 HEER 000-01CE-C499	1150	F	28-Feb-06	905	1222	JUNAGADH	28-Feb-06	Birth	White-coat colour
1395 BADRI 0006B71BCD		M	01-Apr-06	1290	1241	TIRUPATI HYDERABAD	01-Apr-06 05-Aug-11	Birth Transfer	White-coat colour
1396 MOHAN 0006B72D55	1227	M	01-Apr-06	1290	1241	TIRUPATI	01-Apr-06	Birth	White-coat colour
1397 BADRI 0006B71BCD	1228	M	01-Apr-06	1290	1241	TIRUPATI HYDERABAD	01-Apr-06 05-Aug-11	Birth Transfer	White-coat colour

National Stud# House Name LocalID Transponder	Int. Std. #	Sex	Birth Date	Sire	Dam	Location	Date	Event	Old NSB # Remarks
1398 GANGA 0006B71A7A	1229	F	01-Apr-06	1290	1241	TIRUPATI	01-Apr-06	Birth	White-coat colour
1399 HIMA	1230	F	14-Apr-06	1135	860	HYDERABAD MANGALORE	14-Apr-06 05-Mar-14 13-Oct-14	Birth Transfer Death	White-coat colour
1400 BUNTY	1231	F	14-Apr-06	1135	860	HYDERABAD MANGALORE	14-Apr-06 05-Mar-14 13-Oct-14	Birth Transfer Death	White-coat colour
1401 BHEEMA 10025 TPAT28	1232	M	14-Apr-06	1135	860	HYDERABAD PATNA	14-Apr-06 12-Aug-11	Birth Transfer	White-coat colour
1402 KAVERI 9.56E+12	1194	F	~ 1998	WILD	WILD	INDIA KHAIRBARI DARJEELIN	~May 2006±1m ~May 2006±1m 19-Oct-06 10-Nov-17	Capture Transfer Transfer Death	Normal-coat colour
1403 MUKTI 142	1193	F	~ 2000	WILD	WILD	INDIA KHAIRBARI DARJEELIN	~May 2006±1m ~May 2006±1m 19-Oct-06 21-Aug-17	Capture Transfer Transfer Death	Normal-coat colour
1404	1195	M	????	WILD	WILD	TAMILNADU MADRAS	~ 9 May 2006 09-May-06 19-May-06	Capture Transfer Death	Normal-coat colour
1405 SAGAR	1579	M	????	UNK	UNK	INDIA VANVIHAR	???? 19-May-06 15-Oct-10	Birth Transfer Death	Normal-coat colour
1406 BHOOMI 000-6CC-10-AB	1166	F	21-May-06	734	1113	VADODARA RAJKOT	21-May-06 18-Jul-10	Birth Transfer	White-coat colour
1407 DHARTI 000-6CC-240-B	1167	F	21-May-06	734	1113	VADODARA	21-May-06	Birth	White-coat colour
1408 PRUTHVI 000-6CC-2515	1165	F	21-May-06	734	1113	VADODARA	21-May-06	Birth	White-coat colour
1409 RAJEEB	1168	M	~ 2003	WILD	WILD	INDIA ASSAM	~ 2006 02-Jun-06 11-May-12	Capture Transfer Death	Normal-coat colour
1410 HIMALAYA	1196	M	17-Jun-06	1136	755	BHILAI	17-Jun-06 21-Jun-06	Birth Death	Normal-coat colour
1411 SATPURA RAJA	1169	M	17-Jun-06	1136	755	BHILAI	17-Jun-06	Birth	Normal-coat colour
1412 NANDI	1170	M	17-Jun-06	1136	755	BHILAI	17-Jun-06	Birth	Normal-coat colour
1413 NARMADA	1171	F	17-Jun-06	1136	755	BHILAI	17-Jun-06 01-Jul-15	Birth Death	Normal-coat colour
1414 LUCKY	1233	M	20-Jun-06	886	1219	DELHI CHATBIR Z	20-Jun-06 23-Mar-07	Birth Transfer	Normal-coat colour
1415	1234	M	20-Jun-06	886	1219	DELHI	20-Jun-06	Birth	Normal-coat colour
1416	1235	F	20-Jun-06	886	1219	DELHI CHATBIR Z	20-Jun-06 23-Mar-07	Birth Transfer	Normal-coat colour
1417 VINA 260031	1236	F	20-Jun-06	886	1219	DELHI	20-Jun-06	Birth	Normal-coat colour
1418 VICKY	1237	M	21-Jun-06	886	1219	DELHI	21-Jun-06	Birth	Normal-coat colour
1419 MADHU	1692	M	25-Jun-07	1268	1184	BANNERGHA	25-Jun-07	Birth	Normal-coat colour
1420 VISMAYA	1693	F	25-Jun-07	1268	1184	BANNERGHA	25-Jun-07	Birth	Normal-coat colour

National Stud# House Name LocalID Transponder	Int. Std. #	Sex	Birth Date	Sire	Dam	Location	Date	Event	Old NSB # Remarks
1421 SATPURA	1172	M	08-Aug-06	1202	776	BHILAI	08-Aug-06 21-Aug-16	Birth Death	White-coat colour
1422 GANGA	1173	F	08-Aug-06	1202	776	BHILAI	08-Aug-06	Birth	White-coat colour
1423 SAMRAT 244	1653	M	08-Sep-06	997	1163	CALCUTTA DARJEELIN	08-Sep-06 05-Jul-10	Birth Transfer	White-coat colour
1424	1644	M	08-Sep-06	997	1163	CALCUTTA	08-Sep-06	Birth	White-coat colour
1425 JO		M	20-Sep-06	1135	1240	HYDERABAD	20-Sep-06	Birth	White-coat colour
1426 SHANKAR 10031	1655	M	20-Sep-06	510	950	HYDERABAD PATNA	20-Sep-06 12-Aug-11 05-Jun-16	Birth Transfer Death	White-coat colour
1427 SAMEER 10030	1656	M	20-Sep-06	510	950	HYDERABAD TIRUPATI	20-Sep-06 08-Aug-11	Birth Transfer	White-coat colour
1428 SUREKHA/SAM 10032	1657	F	20-Sep-06	510	950	HYDERABAD	20-Sep-06	Birth	White-coat colour
1429 SWATY 10033	1658	F	20-Sep-06	510	950	HYDERABAD	20-Sep-06 24-May-13	Birth Death	White-coat colour
1430 BANDHAVI 9.81098E+1275	1174	F	~ 1998	WILD	WILD	MADHYA PR VANVIHAR	~ 5 Oct 2006 05-Oct-06 09-Jun-10	Capture Transfer Death	Normal- coat colour
1431 ERA 9.81098E+1230	1175	F	~ May 2006	WILD	WILD	MADHYA PR VANVIHAR	~18 Oct 2006 18-Oct-06 02-Jun-09	Capture Transfer Death	Normal- coat colour
1432 SARA 9.81098E+1214	1176	F	~ May 2006	WILD	WILD	MADHYA PR VANVIHAR NANDANKAN	~18 Oct 2006 18-Oct-06 18-Apr-09	Capture Transfer Transfer	Normal- coat colour
1433 NIGLO RBT16 9.81001E+1295	1152	M	29-Dec-06	UNK	1090	ITANAGAR	29-Dec-06	Birth	Normal- coat colour
1434 TAGIA RBT15 9.61001E+1261	1151	M	29-Dec-06	UNK	1090	ITANAGAR	29-Dec-06	Birth	Normal- coat colour
1435 NANG RBT18 9.61001E+1265	1154	F	29-Dec-06	UNK	1090	ITANAGAR	29-Dec-06	Birth	Normal- coat colour
1436 ONI RBT17 9.61001E+12	1153	F	29-Dec-06	UNK	1090	ITANAGAR	29-Dec-06 24-Sep-12	Birth Death	Normal- coat colour
1437 MANIKANTAN	1659	M	13-Jan-07	1345	1001	TRIVANDRU	13-Jan-07	Birth	Normal- coat colour
1438 PONNU	1660	F	13-Jan-07	1345	1001	TRIVANDRU	13-Jan-07	Birth	Normal- coat colour
1439 MANNU	1661	M	13-Jan-07	1345	1001	TRIVANDRU	13-Jan-07	Birth	Normal- coat colour
1440	1238	F	16-Jan-07	1155	933	NANDANKAN	16-Jan-07 16-Jun-07	Birth Death	White-coat colour
1441	1239	M	17-Jan-07	1155	933	NANDANKAN	17-Jan-07 17-Jan-07	Birth Death	White-coat colour
1442 RAJA 260037	1240	M	06-Feb-07	669	1221	DELHI JAIPUR	06-Feb-07 21-Sep-15	Birth Transfer	White-coat colour

National Stud# House Name LocalID Transponder	Int. Std. #	Sex	Birth Date	Sire	Dam	Location	Date	Event	Old NSB # Remarks
1443 SAMBO	1241	F	06-Feb-07	669	1221	DELHI BILASPUR	06-Feb-07 28-Jul-08	Birth Transfer	White-coat colour
1444 AMBO	1242	F	06-Feb-07	669	1221	DELHI	06-Feb-07	Birth	White-coat colour
1445 SEETHA	1662	F	25-Mar-07	1249	992	SHIMOGA	25-Mar-07	Birth	Normal- coat colour
1446 SITA	1197	F	~ 2001	WILD	WILD	INDIA NANDANKAN	~ 1 Apr 2007 01-Apr-07 16-Sep-09	Capture Transfer Death	Normal- coat colour
1447 JOY 0006B73926	1177	M	~ 2006	WILD	WILD	INDIA ASSAM	~19 Apr 2007 19-Apr-07 11-Apr-10	Capture Transfer Death	Normal- coat colour
1448 VIVEK 10025		M	01-Jun-07	WILD	WILD	KAZIRANGA VANVIHAR	01-Jun-07 20-May-11 21-May-14	Birth Transfer Death	Normal- coat colour
1449 KUMARA	1663	M	29-Jun-07	1254	1281	MANGALORE	29-Jun-07	Birth	Normal- coat colour
1450 SHAMBHAVI 100005	1664	F	29-Jun-07	1254	1281	MANGALORE	29-Jun-07	Birth	Normal- coat colour
1451 NETHRAVATHY 100006	1665	F	29-Jun-07	1254	1281	MANGALORE	29-Jun-07	Birth	Normal- coat colour
1452 RANI 77	1199	F	15-Jun-07	WILD	WILD	INDIA NAINITAL	???? 10-Jul-08	Capture Transfer	Normal- coat colour
1453 NZP 260034	1244	F	21-Jul-07	UNK	1219	DELHI TRIVANDRU	21-Jul-07 14-Oct-14	Birth Transfer	White-coat colour
1454 PATTU 260033 10031	1243	F	21-Jul-07	886	1219	DELHI VANVIHAR REWA	21-Jul-07 21-Mar-14 08-Nov-15	Birth Transfer Transfer	White-coat colour
1455 VIJAY		M	21-Jul-07	886	1219	DELHI	21-Jul-07	Birth	White-coat colour
1456 KAMLESH 10033 10016		F	05-Aug-08	UNK	UNK	INDORE VANVIHAR	05-Aug-08 09-Mar-17	Birth Transfer	Normal- coat colour
1457 BIRINA	1666	F	17-Aug-07	1335	991	ASSAM	17-Aug-07	Birth	Normal- coat colour
1458 AMAR		M	24-Aug-07	1265	1266	BANNERGHA	24-Aug-07	Birth	White-coat colour
1459 SURYA		M	24-Aug-07	1265	1266	BANNERGHA	24-Aug-07	Birth	White-coat colour
1460 VINAY	1694	M	24-Jan-08	1265	1266	BANNERGHA	24-Jan-08	Birth	White-coat colour
1461 SHREYAS	1695	M	24-Jan-08	1265	1266	BANNERGHA	24-Jan-08	Birth	White-coat colour
1462 SINDHU	1698	F	24-Jan-08	1265	1266	BANNERGHA	24-Jan-08	Birth	White-coat colour
1463 PACH2	1667	F	14-Feb-08	1269	1302	LUDHIANA CHATBIR Z	14-Feb-08 28-May-08 21-Oct-08	Birth Transfer Death	Normal- coat colour
1464 CHIRAG	1668	M	14-Feb-08	1269	1302	LUDHIANA CHATBIR Z	14-Feb-08 28-May-08	Birth Transfer	Normal- coat colour
1465 PRITHVI	1669	M	14-Feb-08	1269	1302	LUDHIANA CHATBIR Z	14-Feb-08 28-May-08	Birth Transfer	Normal- coat colour
1466	1670	?	14-Feb-08	1269	1302	LUDHIANA	14-Feb-08 ????	Birth Death	Normal- coat colour

National Stud# House Name LocalID Transponder	Int. Std. #	Sex	Birth Date	Sire	Dam	Location	Date	Event	Old NSB # Remarks
1467 SATNA		M	????	WILD	WILD	MADHYA PR VANVIHAR	17-Feb-08 18-Feb-08 22-Feb-08	Capture Transfer Death	Normal- coat colour
1468 MANISH 98102056660	1245	M	28-Feb-08	757	847	NANDANKAN	28-Feb-08	Birth	White-coat colour
1469 RENUKA 98102055402	1246	F	28-Feb-08	757	847	NANDANKAN	28-Feb-08	Birth	White-coat colour
1470 BRAHMA 0006B73ADA M00072	1198	M	~ 2000	WILD	WILD	KARNATAKA MYSORE	17-Mar-08 18-Mar-08	Capture Transfer	Normal- coat colour
1471 KRISHNA 0006B77FAO	1671	M	08-May-08	1195	1251	ASSAM	08-May-08 21-Oct-13	Birth Death	Normal- coat colour
1472	1672	F	08-May-08	1195	1251	ASSAM	08-May-08 27-Sep-08	Birth Death	Normal- coat colour
1473 KANHA 9.81098E+1226	1178	M	~ 2005	WILD	WILD	MADHYA PR VANVIHAR	~16 May 2008 16-May-08 16-May-08	Capture Transfer Death	Normal- coat colour
1474 RAMYA M13-04	1770	F	~ 2008	UNK	UNK	INDIA TIRUPATI	~ 2008 21-Dec-12	Birth Transfer	Normal- coat colour
1475 YASH	1247	M	08-Oct-08	1321	1291	BORIVILLI	08-Oct-08	Birth	White-coat colour
1476 LAXMI	1248	F	08-Oct-08	1321	1291	BORIVILLI	08-Oct-08	Birth	White-coat colour
1477 PAYAL 98102057603	1249	F	20-Oct-08	949	1154	NANDANKAN CALCUTTA	20-Oct-08 19-Feb-16	Birth Transfer	White-coat colour
1478	1250	F	20-Oct-08	949	1154	NANDANKAN	20-Oct-08 25-Oct-08	Birth Death	White-coat colour
1479 KHUSHI 98102057846	1251	F	20-Oct-08	949	1154	NANDANKAN ASSAM	20-Oct-08 23-Aug-11	Birth Transfer	White-coat colour
1480	1252	F	20-Oct-08	949	1154	NANDANKAN	20-Oct-08 20-Oct-08	Birth Death	White-coat colour
1481 ANUSUYA 0006B76068 M00080	1200	F	~15 Aug 2008	WILD	WILD	KARNATAKA MYSORE GADAG	~28 Oct 2008 28-Oct-08 05-Dec-17	Capture Transfer Transfer	Normal- coat colour
1482 NAHAR 9.81098E+1258	1179	M	~ Jun 2005	WILD	WILD	MADHYA PR VANVIHAR JAIPUR	~ 8 Dec 2008 08-Dec-08 21-Mar-13	Capture Transfer Transfer	Normal- coat colour
1483 SWARNA TPAT30	1772	F	02-Jan-09	1290	1241	TIRUPATI PATNA	02-Jan-09 12-Aug-11	Birth Transfer	White-coat colour
1484	1253	F	04-Jan-09	1155	933	NANDANKAN	04-Jan-09 06-Jan-09	Birth Death	White-coat colour
1485	1254	F	04-Jan-09	1155	933	NANDANKAN	04-Jan-09 06-Jan-09	Birth Death	White-coat colour
1486 76	1201	M	~ 2008	WILD	WILD	UTTARANCH NAINITAL	~ 4 Feb 2009 04-Feb-09 01-Mar-15	Capture Transfer Death	Normal- coat colour
1487 KISHAN	1202	M	~ 2006	WILD	WILD	INDIA LUCKNOW	~ 2 Mar 2009 02-Mar-09	Capture Transfer	Normal- coat colour

National Stud# House Name LocalID Transponder	Int. Std. #	Sex	Birth Date	Sire	Dam	Location	Date	Event	Old NSB # Remarks
1488 RIDDHI 10032		F	07-Mar-09	UNK	UNK	INDORE VANVIHAR	07-Mar-09 28-Dec-13	Birth Transfer	Normal- coat colour
1489 RANI		F	????	WILD	WILD	INDIA VANVIHAR	22-Mar-09 22-Mar-09 02-Apr-09	Capture Transfer Death	Normal- coat colour
1490 AKANSHA 100183	1730	F	24-Mar-09	1371	1380	MADRAS	24-Mar-09	Birth	White-coat colour
1491 NAMRUTHA 100184	1731	F	24-Mar-09	1371	1380	MADRAS	24-Mar-09	Birth	White-coat colour
1492 PANCHAM		M	????	WILD	WILD	MADHYA PR VANVIHAR	03-Apr-09 04-Apr-09 14-Apr-09	Capture Transfer Death	Normal- coat colour
1494 GIRI	1673	M	13-Apr-09	1213	1357	VISAKAPAT	13-Apr-09	Birth	White-coat colour
1495 VANI	1674	F	13-Apr-09	1213	1357	VISAKAPAT	13-Apr-09	Birth	White-coat colour
1496 VEENA	1675	F	13-Apr-09	1213	1357	VISAKAPAT	13-Apr-09	Birth	White-coat colour
1497 VIJAY	1676	M	16-Oct-09	1249	992	SHIMOGA	16-Oct-09	Birth	Normal- coat colour
1498 DASHAMI	1677	M	16-Oct-09	1249	992	SHIMOGA	16-Oct-09	Birth	Normal- coat colour
1499 KADAMBA	1678	M	09-Nov-09	1256	1281	MANGALORE HYDERABAD	09-Nov-09 09-Nov-09	Birth Transfer	Normal- coat colour
1500 77		F	~ 2006	WILD	WILD	INDIA NAINITAL	???? ~ 2010	Capture Transfer	Normal- coat colour
1501	1258	F	01-Mar-10	949	1154	NANDANKAN	01-Mar-10	Birth	White-coat colour
1502	1256	F	01-Mar-10	949	1154	NANDANKAN	01-Mar-10 04-Mar-10	Birth Death	White-coat colour
1503 SAMRAT	1257	M	01-Mar-10	949	1154	NANDANKAN	01-Mar-10	Birth	White-coat colour
1504 SNEHA	1255	F	01-Mar-10	949	1154	NANDANKAN	01-Mar-10	Birth	White-coat colour
1505	1259	F	01-Mar-10	949	1154	NANDANKAN	01-Mar-10 14-Mar-10	Birth Death	White-coat colour
1506 RIDDHI 0007503D88		F	06-Mar-10	1116	1388	AURANGABA PUNE	06-Mar-10 11-Apr-15	Birth Transfer	Normal- coat colour
1507 CHITRA	1679	F	02-Apr-10	1414	1302	CHATBIR Z	02-Apr-10	Birth	White-coat colour
1508 M20-12		F	02-May-10	1290	1241	TIRUPATI	02-May-10 09-Dec-12	Birth Death	White-coat colour
1510 RANI M20W13	1775	F	02-May-10	1290	1241	TIRUPATI	02-May-10	Birth	White-coat colour
1511 KAILASH 9.56E+12	1744	M	02-May-10	1290	1241	TIRUPATI TATA	02-May-10 02-Mar-14	Birth Transfer	White-coat colour
1512 KAVERI M00078	1203	F	~ 2000	WILD	WILD	KARNATAKA MYSORE	~ 3 Jun 2010 03-Jun-10 16-Jul-15	Capture Transfer Death	Normal- coat colour
1513 SEMBIAN AAZP6	1732	M	06-Jun-10	1371	1380	MADRAS	06-Jun-10 21-Aug-13	Birth Death	White-coat colour
1514 INDIRA AAZP7	1733	F	06-Jun-10	1371	1380	MADRAS	06-Jun-10	Birth	White-coat colour

National Stud# House Name LocalID Transponder	Int. Std. #	Sex	Birth Date	Sire	Dam	Location	Date	Event	Old NSB # Remarks
1515 VALLI AAZP8	1734	F	06-Jun-10	1371	1380	MADRAS	06-Jun-10 30-Jun-15	Birth Death	White-coat colour
1516 PRASHANT	1204	M	~ Apr 2006	WILD	WILD	INDIA LUCKNOW KANPUR	~15 Oct 2010 15-Oct-10 24-Oct-10	Capture Transfer Transfer	Normal- coat colour
1517 SILARAI 0006CBC9DB	1680	M	29-Oct-10	1335	991	ASSAM	29-Oct-10 29-Mar-17	Birth Death	Normal- coat colour
1518 LACHIT	1681	M	29-Oct-10	1335	991	ASSAM	29-Oct-10 27-Jun-17	Birth Death	Normal- coat colour
1519 SIVAJI	1682	M	29-Oct-10	1335	991	ASSAM RAIPUR	29-Oct-10 ????	Birth Transfer	Normal- coat colour
1520 RAHUL M01167	1765	M	~ Jan 2011	WILD	WILD	KARNATAKA MYSORE	~ Jan 2011 09-Jul-15	Capture Transfer	Normal- coat colour
1521 RAJAT 315	1708	M	25-Feb-11	UNK	UNK	BANNERGHA	25-Feb-11	Birth	Normal- coat colour
1522 SAVITRI		F	16-Mar-11	UNK	1357	VISAKAPAT	16-Mar-11	Birth	White-coat colour
1523 DHARA	1683	F	04-Apr-11	1168	1113	RAJKOT	04-Apr-11	Birth	White-coat colour
1524		M	24-Apr-11	UNK	UNK	VANVIHAR	24-Apr-11 24-Apr-11	Birth Death	Normal- coat colour
1525		M	24-Apr-11	UNK	UNK	VANVIHAR	24-Apr-11 06-May-11	Birth Death	Normal- coat colour
1526 SHIVA		M	11-May-11	1244	1246	BANNERGHA RANCHI	11-May-11 24-Nov-14	Birth Transfer	Normal- coat colour
1527 M00664	1684	F	16-May-11	1470	1378	MYSORE	16-May-11 21-May-11	Birth Death	White-coat colour
1528 LAKSHMAN M00665 9.56E+1227	1685	M	16-May-11	1470	1378	MYSORE GADAG	16-May-11 05-Dec-17	Birth lft	White-coat colour
1529 M00666 9.56E+1229	1686	M	16-May-11	1470	1378	MYSORE DELHI	16-May-11 26-Mar-14	Birth Transfer	White-coat colour
1530 DIWAKAR 00074D6238	1260	M	16-May-11	1202	1203	BHILAI RAJKOT	16-May-11 19-Nov-14	Birth Transfer	White-coat colour
1531 GAYATRI 00074C86EE	1261	F	16-May-11	1202	1203	BHILAI RAJKOT	16-May-11 19-Nov-14	Birth Transfer	White-coat colour
1532 YASHODHRA 00074D5836	1262	F	16-May-11	1202	1203	BHILAI RAJKOT	16-May-11 19-Nov-14	Birth Transfer	White-coat colour
1533	1263	?	30-May-11	1337	1362	KANPUR	30-May-11	Birth	White-coat colour
1534	1264	?	30-May-11	1337	1362	KANPUR	30-May-11	Birth	White-coat colour
1535	1265	?	30-May-11	1337	1362	KANPUR	30-May-11	Birth	White-coat colour
1536 VASUNDHRA	1266	F	19-Jun-11	1411	1413	BHILAI	19-Jun-11	Birth	Normal- coat colour
1537 10021 260043	1778	M	~ 2009	WILD	WILD	BANDHAVG VANVIHAR DELHI	???? 10-Jul-11 20-Mar-14	Capture Transfer Transfer	Normal- coat colour
1538 RAGINI	1267	F	13-Jul-11	949	1154	NANDANKAN	13-Jul-11	Birth	White-coat colour
1539 BIJAYA	1268	F	13-Jul-11	949	1154	NANDANKAN	13-Jul-11	Birth	White-coat colour

National Stud# House Name LocalID Transponder	Int. Std. #	Sex	Birth Date	Sire	Dam	Location	Date	Event	Old NSB # Remarks
1540 RAMA 100363		M	03-Aug-11	1371	1380	MADRAS UDAIPUR	03-Aug-11 25-Sep-16	Birth Transfer	White-coat colour
1541 CHANDRA 100364		F	03-Aug-11	1371	1380	MADRAS	03-Aug-11 23-Jan-15	Birth Death	White-coat colour
1543 PRABHAS	1782	M	24-Sep-11	1401	1240	HYDERABAD	24-Sep-11	Birth	White-coat colour
1544 SAIF	1784	M	24-Sep-11	1401	1240	HYDERABAD	24-Sep-11	Birth	White-coat colour
1545 ANUSHKA 230040 TIGER7		F	24-Oct-11	1401	1240	HYDERABAD RANCHI	24-Oct-11 27-Feb-16	Birth Transfer	White-coat colour
1546 KRISHNA 100118	1687	M	09-Nov-11	1256	1451	MANGALORE SURAT	09-Nov-11 07-Apr-14	Birth Transfer	Normal- coat colour
1547		M	16-Nov-11	1276	1160	NANDANKAN	16-Nov-11 18-Nov-11	Birth Death	White-coat colour
1548		M	16-Nov-11	1276	1160	NANDANKAN	16-Nov-11	Birth	White-coat colour
1549		M	16-Nov-11	1276	1160	NANDANKAN	16-Nov-11	Birth	White-coat colour
1550		F	16-Nov-11	1276	1160	NANDANKAN	16-Nov-11 18-Nov-11	Birth Death	White-coat colour
1551		F	16-Nov-11	1276	1160	NANDANKAN	16-Nov-11	Birth	White-coat colour
1552		M	20-Nov-11	UNK	UNK	VANVIHAR	20-Nov-11 20-Nov-11	Birth Death	Normal- coat colour
1553		M	20-Nov-11	UNK	UNK	VANVIHAR	20-Nov-11 22-Nov-11	Birth Death	Normal- coat colour
1554 M00955	1718	F	29-Nov-11	1275	1512	MYSORE	29-Nov-11 04-Dec-11	Birth Death	White-coat colour
1555 RADHA		F	29-Nov-11	1421	1422	BHILAI REWA	29-Nov-11 05-Dec-15	Birth Transfer	White-coat colour
1556 VISHAKHA		F	29-Nov-11	1421	1422	BHILAI LUCKNOW	29-Nov-11 19-Jul-14	Birth Transfer	White-coat colour
1557 NANDINI 0006CDF46F		F	06-Jan-12	1351	1479	ASSAM	06-Jan-12	Birth	White-coat colour
1558 NANDITA		F	06-Jan-12	1351	1479	ASSAM	06-Jan-12 23-Feb-16	Birth Death	White-coat colour
1559		F	06-Jan-12	1351	1479	ASSAM	06-Jan-12 20-Apr-12	Birth Death	White-coat colour
1560 SHRUTI	1735	F	06-Jan-12	UNK	1479	ASSAM	06-Jan-12 28-Apr-12	Birth Death	White-coat colour
1561 ASHA		F	13-Jan-12	1350	1432	NANDANKAN HYDERABAD	13-Jan-12 09-Dec-16	Birth Transfer	White-coat colour
1562 ANKITA		F	13-Jan-12	1350	1432	NANDANKAN	13-Jan-12	Birth	White-coat colour
1563 SUBHASHREE		F	13-Jan-12	1350	1432	NANDANKAN	13-Jan-12	Birth	White-coat colour
1564 TEJASWINI	1714	F	10-Feb-12	1183	1049	BANNERGHA RANCHI	10-Feb-12 24-Nov-14 22-Dec-15	Birth Transfer Death	Normal- coat colour
1565 DONA 0006B71DOE		F	16-Apr-12	1382	1147	TATA	16-Apr-12	Birth	Normal- coat colour
1566 KRISHNA M20W16	1787	M	02-May-12	1290	1241	TIRUPATI	02-May-12	Birth	White-coat colour

National Stud# House Name LocalID Transponder	Int. Std. #	Sex	Birth Date	Sire	Dam	Location	Date	Event	Old NSB # Remarks
1567 BALARAM M20W17	1788	M	02-May-12	1290	1241	TIRUPATI	02-May-12	Birth	White-coat colour
1568 SUBHADRA M20W18	1789	F	02-May-12	1290	1241	TIRUPATI	02-May-12	Birth	White-coat colour
1569 KHIRI		M	15-Jun-12	WILD	WILD	LUCKNOW	15-Jun-12	Birth	Normal- coat colour
1570 AMAN		M	07-Jul-12	1337	1362	KANPUR CHATBIR Z	07-Jul-12 01-Feb-15	Birth Transfer	White-coat colour
1571 CHITRA		F	07-Jul-12	1337	1362	KANPUR RAIPUR	07-Jul-12 11-Aug-16	Birth Transfer	White-coat colour
1572 TPAT31		F	31-Jul-12	1401	1483	PATNA	31-Jul-12 03-Sep-12	Birth Death	White-coat colour
1573 TPAT32		F	31-Jul-12	1401	1483	PATNA	31-Jul-12 28-Aug-12	Birth Death	White-coat colour
1574 TPAT33		M	31-Jul-12	1401	1483	PATNA	31-Jul-12 02-Sep-12	Birth Death	White-coat colour
1575 M00956	1719	F	11-Aug-12	1275	1512	MYSORE	11-Aug-12 13-Aug-12	Birth Death	White-coat colour
1576 M00957	1720	F	11-Aug-12	1275	1512	MYSORE	11-Aug-12 13-Aug-12	Birth Death	White-coat colour
1577 M00958	1721	F	11-Aug-12	1275	1512	MYSORE	11-Aug-12 13-Aug-12	Birth Death	White-coat colour
1578 MAHADESHA 9.56E+12 M00882	1737	M	~ Jun 2000	WILD	WILD	INDIA MYSORE BANNERGHA	~ 1 Aug 2012 26-Aug-12 15-Nov-12	Capture Transfer Transfer	Normal- coat colour
1579 NAGARAJA M00992	1738	M	~ Aug 1998	WILD	WILD	INDIA MYSORE	???? 20-Oct-12 26-Oct-12	Capture Transfer Death	Normal- coat colour
1580 SHARAN		M	20-Oct-12	1395	1428	HYDERABAD	20-Oct-12	Birth	White-coat colour
1581 KIRAN		M	20-Oct-12	1395	1428	HYDERABAD	20-Oct-12	Birth	White-coat colour
1582 ARJUNA 100437	1793	M	23-Oct-12	1371	1380	MADRAS	23-Oct-12	Birth	White-coat colour
1583 ATHAYA 100438	1794	M	23-Oct-12	1371	1380	MADRAS	23-Oct-12	Birth	White-coat colour
1584 CAUVERY 100439	1795	F	23-Oct-12	1371	1380	MADRAS	23-Oct-12	Birth	White-coat colour
1585 CHITRA 100440	1796	F	23-Oct-12	1371	1380	MADRAS	23-Oct-12 17-Oct-13	Birth Death	White-coat colour
1586 OLIVER 100134		M	05-Nov-12	1256	1481	MANGALORE	05-Nov-12	Birth	Normal- coat colour
1587 VINAYA 100133 528		M	05-Nov-12	1256	1481	MANGALORE BANNERGHA	05-Nov-12 06-Jul-17 04-Feb-18	Birth Transfer Death	Normal- coat colour
1588 NETHRA 100434	1797	F	07-Nov-12	1294	1490	MADRAS	07-Nov-12	Birth	White-coat colour
1589 VIDHYA 100435	1798	F	07-Nov-12	1294	1490	MADRAS	07-Nov-12	Birth	White-coat colour

National Stud# House Name LocalID Transponder	Int. Std. #	Sex	Birth Date	Sire	Dam	Location	Date	Event	Old NSB # Remarks
1590 ARTHI 100436	1799	F	07-Nov-12	1294	1490	MADRAS	07-Nov-12	Birth	White-coat colour
1591 9.56E+12QT11	1269	F	~ Sep 2009	WILD	WILD	INDIA MYSORE	???? 04-Dec-12	Capture Transfer	Normal-coat colour
1592 DURGA	1726	F	11-Dec-12	UNK	1479	ASSAM	11-Dec-12	Birth	White-coat colour
1593 CHIPI		F	~ 2012	WILD	WILD	INDIA ITANAGAR	13-Dec-12 28-Sep-13	Capture Transfer	Normal-coat colour
1594 IPRA		M	~ 2012	WILD	WILD	INDIA ITANAGAR	13-Dec-12 28-Sep-13	Capture Transfer	Normal-coat colour
1595 BANDHU 0007156C86 10018		M	01-Jan-13	WILD	WILD	BANDHAVG VANVIHAR	01-Jan-13 27-Jun-16	Birth Transfer	Normal-coat colour
1596 MAILANI-1		F	15-Aug-12	WILD	WILD	INDIA LUCKNOW	???? 26-Feb-13	Capture Transfer	Normal-coat colour
1597 MALLIK		M	21-May-13	1135	1240	HYDERABAD RANCHI	21-May-13 01-Mar-16	Birth Transfer	White-coat colour
1598 MRUTHYUNJAY M01053 A00074D6A59	1722	M	04-Jun-13	1470	1378	MYSORE	04-Jun-13	Birth	White-coat colour
1599 VAYAPUTRA M01054 00071541F3	1723	M	04-Jun-13	1470	1378	MYSORE	04-Jun-13	Birth	White-coat colour
1600 PRUTHVI M01056 00074C47F4	1725	M	04-Jun-13	1470	1378	MYSORE	04-Jun-13	Birth	White-coat colour
1601 NAKULA M01055 00074D622F 260040	1724	M	04-Jun-13	1470	1378	MYSORE DELHI	04-Jun-13 26-Mar-14	Birth Transfer	White-coat colour
1602 NANDAN		M	07-Jul-13	WILD	WILD	NANDANKAN	07-Jul-13	Birth	Normal-coat colour
1603 POOJA M01060 00074D4ACC	1271	F	18-Jul-13	1470	1481	MYSORE	18-Jul-13 27-Sep-14	Birth Death	Normal-coat colour
1604 JYOTHI M01061 00074D3D20	1270	F	18-Jul-13	1470	1481	MYSORE	18-Jul-13 16-Jan-14	Birth Death	Normal-coat colour
1605 NT21	1273	F	18-Jul-13	1470	1481	MYSORE	18-Jul-13 19-Jul-13	Birth Death	Normal-coat colour
1606 NT22	1274	F	18-Jul-13	1470	1481	MYSORE	18-Jul-13 19-Jul-13	Birth Death	Normal-coat colour
1607 LUV		M	28-Jul-13	UNK	UNK	CHATBIR Z KANPUR	28-Jul-13 03-Feb-15	Birth Transfer	Normal-coat colour
1608 RAGHU		M	15-Aug-13	1421	1422	BHILAI REWA	15-Aug-13 05-Dec-15	Birth Transfer	White-coat colour
1609 RAJAN		M	15-Aug-13	1421	1422	BHILAI INDORE	15-Aug-13 27-Nov-14	Birth Transfer	White-coat colour
1610 ROMA		F	15-Aug-13	1421	1422	BHILAI	15-Aug-13	Birth	White-coat colour
1611 DIVAYANI		F	06-Sep-13	1395	1428	HYDERABAD	06-Sep-13	Birth	White-coat colour
1612 DHARMA		M	06-Sep-13	1395	1428	HYDERABAD	06-Sep-13	Birth	White-coat colour

National Stud# House Name LocalID Transponder	Int. Std. #	Sex	Birth Date	Sire	Dam	Location	Date	Event	Old NSB # Remarks
1613 DHANUSH		M	06-Sep-13	1395	1428	HYDERABAD	06-Sep-13	Birth	White-coat colour
1614 UTHIRA 100532	1785	F	~ Dec 2013	WILD	WILD	INDIA MADRAS	~ 1 Sep 2014 24-Sep-14	Capture Transfer	Normal- coat colour
1615 SHIVA 9.56E+1209 M01089	1272	M	~ Apr 2002	WILD	WILD	KARNATAKA MYSORE	???? 05-Dec-13	Capture Transfer	Normal- coat colour
1616 GOPI		M	07-Dec-13	1202	1203	BHILAI	07-Dec-13	Birth	White-coat colour
1617 KISHAN		M	07-Dec-13	1202	1203	BHILAI	07-Dec-13	Birth	White-coat colour
1618 10022		M	~ 2009	UNK	UNK	VANVIHAR INDORE	???? 27-Dec-13	Capture Transfer	Normal- coat colour
1619 KAZI		F	????	WILD	WILD	INDIA ASSAM	???? 22-Jan-14	Capture Transfer	Normal- coat colour
1620 SHEELA		F	27-Jan-14	1276	1160	NANDANKAN CALCUTTA	27-Jan-14 19-Feb-16	Birth Transfer	White-coat colour
1621 NAKUL 0007155DBA		M	16-Feb-14	1158	1157	AURANGABA REWA	16-Feb-14 16-Jan-16	Birth Transfer	Normal- coat colour
1622 DURGA 00071539F8		F	16-Feb-14	1158	1157	AURANGABA REWA	16-Feb-14 16-Jan-16	Birth Transfer	Normal- coat colour
1623 ARJOON 00074D4F0D		M	16-Feb-14	1158	1157	AURANGABA	16-Feb-14	Birth	Normal- coat colour
1624 SHRWAN 260042	1727	M	20-Feb-14	1455	1444	DELHI TRIVANDRU	20-Feb-14 14-Oct-14	Birth Transfer	White-coat colour
1625 RAJA TPAT34		M	04-Mar-14	1401	1483	PATNA	04-Mar-14	Birth	White-coat colour
1626 BHAWANI TPAT35		F	04-Mar-14	1401	1483	PATNA	04-Mar-14	Birth	White-coat colour
1627 DEVI TPAT36		F	04-Mar-14	1401	1483	PATNA	04-Mar-14	Birth	White-coat colour
1629 MANJU 100159		M	04-Mar-14	1256	1451	MANGALORE	04-Mar-14	Birth	Normal- coat colour
1630 AKASHAYA 100158	1768	M	04-Mar-14	1256	1451	MANGALORE	04-Mar-14	Birth	Normal- coat colour
1631 MANJU 100159	1769	M	04-Mar-14	1256	1451	MANGALORE	04-Mar-14	Birth	Normal- coat colour
1632 ADHITHIYA 100530	1801	M	23-Mar-14	1294	1491	MADRAS	23-Mar-14	Birth	White-coat colour
1633 KARNA 100531	1800	M	23-Mar-14	1294	1491	MADRAS	23-Mar-14	Birth	White-coat colour
1634 PANNA 000715UAAF 10020		M	01-May-10	WILD	WILD	INDIA VANVIHAR	???? 28-Mar-14	Capture Transfer	Normal- coat colour
1635 TPAT37		M	05-Mar-14	1401	1483	PATNA	05-Mar-14 24-May-14	Birth Death	White-coat colour

National Stud# House Name LocalID Transponder	Int. Std. #	Sex	Birth Date	Sire	Dam	Location	Date	Event	Old NSB # Remarks
1636 SUBHRANSU		M	28-Jul-14	1468	678	NANDANKAN	28-Jul-14	Birth	White-coat colour
1637 KRISHNA		M	28-Jul-14	1468	678	NANDANKAN	28-Jul-14	Birth	White-coat colour
1638 SNEHASIS		F	28-Jul-14	1468	678	NANDANKAN CALCUTTA	28-Jul-14 19-Feb-16	Birth Transfer	White-coat colour
1639 ANINI		M	28-Jul-14	1468	678	NANDANKAN	28-Jul-14	Birth	White-coat colour
1640 VIVAAN 000757DACE		M	28-Aug-14	1382	1147	TATA	28-Aug-14	Birth	Normal- coat colour
1641 AHANA 000757F723		F	28-Aug-14	1382	1147	TATA	28-Aug-14	Birth	Normal- coat colour
1642 OKKANNA M01130		M	~ Feb 2005	WILD	WILD	KARNATAKA MYSORE	???? 05-Sep-14	Capture Transfer	Normal- coat colour
1643 10034		M	05-Sep-14	1700	UNK	INDORE	05-Sep-14	Birth	Normal- coat colour
1644 ANITHA 100533	1803	F	12-Sep-14	1294	1490	MADRAS	12-Sep-14	Birth	White-coat colour
1645 PRITHA 100534	1804	F	12-Sep-14	1294	1490	MADRAS	12-Sep-14	Birth	White-coat colour
1646 SUNITHA 100535	1805	F	12-Sep-14	1294	1490	MADRAS	12-Sep-14	Birth	White-coat colour
1647 SANGEETHA 100536	1806	F	12-Sep-14	1294	1490	MADRAS	12-Sep-14	Birth	White-coat colour
1649 BAGIRAM 10184	1786	M	~ Jul 2009	WILD	WILD	INDIA PUNE	~ 1 Sep 2014 16-Sep-14	Capture Transfer	Normal- coat colour
1650 JAWARA 317		M	12-Feb-09	WILD	WILD	INDIA BANNERGHA	???? 18-Nov-14	Capture Transfer	Normal- coat colour
1651 RAMYA M01151	1740	F	~ Apr 2005	WILD	WILD	KARNATAKA MYSORE	???? 17-Dec-14	Capture Transfer	Normal- coat colour
1652 ABHIMANYU		M	02-Jan-15	1395	1428	HYDERABAD	02-Jan-15	Birth	White-coat colour
1653 DURGA		F	09-Jan-15	1618	UNK	INDORE	09-Jan-15	Birth	Normal- coat colour
1654 BAALI		M	09-Jan-15	1618	UNK	INDORE	09-Jan-15	Birth	Normal- coat colour
1655 GANGA 10036 10017		F	09-Jan-15	1700	UNK	INDORE VANVIHAR	09-Jan-15 09-Mar-17	Birth Transfer	Normal- coat colour
1656 DHANUSH M01157	1741	M	~ 2014	WILD	WILD	KARNATAKA MYSORE	???? 15-Jan-15 02-Feb-15	Capture Transfer Death	Normal- coat colour
1657 TIPPU 260044 0006B7346C		M	18-Mar-15	1455	1444	DELHI	18-Mar-15	Birth	White-coat colour
1658 GEETA 260045		F	18-Mar-15	1455	1444	DELHI	18-Mar-15	Birth	White-coat colour
1659 260046		F	18-Mar-15	1455	1444	DELHI	18-Mar-15	Birth	White-coat colour

National Stud# House Name LocalID Transponder	Int. Std. #	Sex	Birth Date	Sire	Dam	Location	Date	Event	Old NSB # Remarks
1660 260047		F	18-Mar-15	1455	1444	DELHI	18-Mar-15	Birth	White-coat colour
1661 SANJAY M01161	1742	M	~ Mar 2012	WILD	WILD	KARNATAKA MYSORE	???? 26-Mar-15 08-Jan-16	Capture Transfer Death	Normal-coat colour
1662 BADAL		M	05-May-15	1516	1362	KANPUR	05-May-15	Birth	White-coat colour
1663 00074D5B28		F	06-May-15	1530	1532	RAJKOT	06-May-15	Birth	White-coat colour
1664 00074D399B		F	16-May-15	1530	1531	RAJKOT	16-May-15	Birth	White-coat colour
1665 00074D421B		F	16-May-15	1530	1531	RAJKOT	16-May-15	Birth	White-coat colour
1666 00074CA290		F	16-May-15	1530	1531	RAJKOT	16-May-15	Birth	White-coat colour
1667 7.15E+05		F	16-May-15	1530	1531	RAJKOT	16-May-15	Birth	White-coat colour
1668 BADSHAH		M	23-May-15	1516	1362	KANPUR RAIPUR	23-May-15 11-Aug-16	Birth Transfer	White-coat colour
1669 BARKHA		F	23-May-15	1516	1362	KANPUR	23-May-15	Birth	White-coat colour
1670 RAM		M	15-Jul-15	1421	1422	BHILAI	15-Jul-15	Birth	White-coat colour
1671 SHYAM		M	15-Jul-15	1421	1422	BHILAI	15-Jul-15	Birth	White-coat colour
1672 KARISHAMA 0007153F36		F	22-Jul-15	1158	1506	AURANGABA	22-Jul-15	Birth	Normal-coat colour
1673 KAREENA 7153887		F	22-Jul-15	1158	1506	AURANGABA	22-Jul-15	Birth	Normal-coat colour
1674		F	20-Aug-15	UNK	UNK	VANVIHAR	20-Aug-15 20-Aug-15	Birth Death	Normal-coat colour
1675 NAGULA 100572		M	16-Oct-15	1294	1491	MADRAS	16-Oct-15	Birth	White-coat colour
1676 KALAM 100573		F	16-Oct-15	1294	1491	MADRAS	16-Oct-15	Birth	White-coat colour
1677 DEVAM 100571		M	16-Oct-15	1294	1491	MADRAS	16-Oct-15	Birth	White-coat colour
1678 MALA 100574		F	16-Oct-15	1294	1491	MADRAS	16-Oct-15	Birth	White-coat colour
1679 AMAR 100184		M	19-Mar-16	1256	1451	MANGALORE	19-Mar-16	Birth	Normal-coat colour
1680 AKBAR 100185		M	19-Mar-16	1256	1451	MANGALORE	19-Mar-16	Birth	Normal-coat colour
1681 ANTONY 100186		M	19-Mar-16	1256	1451	MANGALORE	19-Mar-16	Birth	Normal-coat colour
1682 100187		M	19-Mar-16	1256	1451	MANGALORE	19-Mar-16	Birth	Normal-coat colour
1683 BAHUBALI		M	20-Apr-16	1602	706	NANDANKAN	20-Apr-16	Birth	Normal-coat colour
1684 KUNDAN		M	20-Apr-16	1602	706	NANDANKAN	20-Apr-16	Birth	Normal-coat colour
1685 KHAVI		M	23-Apr-16	1395	1428	HYDERABAD	23-Apr-16	Birth	White-coat colour

National Stud# House Name LocalID Transponder	Int. Std. #	Sex	Birth Date	Sire	Dam	Location	Date	Event	Old NSB # Remarks
1686 NAGAMANI		F	23-Apr-16	1395	1428	HYDERABAD	23-Apr-16	Birth	White-coat colour
1687		M	25-May-16	UNK	1469	NANDANKAN	25-May-16 25-May-16	Birth Death	White-coat colour
1688 M01301		M	~ Jun 2016	WILD	WILD	INDIA MYSORE	???? 27-Mar-17	Capture Transfer	Normal-coat colour
1689 SONAM		F	04-Jul-16	1421	1422	BHILAI	04-Jul-16	Birth	White-coat colour
1690 SULTAN		M	04-Jul-16	1421	1422	BHILAI	04-Jul-16	Birth	White-coat colour
1691 MATAKKALI 000715064B 10015		F	01-Aug-16	UNK	UNK	INDIA VANVIHAR	01-Aug-16 21-Nov-16	Birth Transfer	Normal-coat colour
1692 VICKY TC3		M	05-Aug-16	1468	678	NANDANKAN	05-Aug-16	Birth	White-coat colour
1693 CHINU TC4		M	05-Aug-16	1468	678	NANDANKAN	05-Aug-16	Birth	White-coat colour
1694 MOUSUMI TC5		F	05-Aug-16	1468	678	NANDANKAN	05-Aug-16	Birth	White-coat colour
1695 SAHIL		M	09-Aug-16	1276	UNK	NANDANKAN	09-Aug-16	Birth	White-coat colour
1696 ADYASHA		F	09-Aug-16	1276	UNK	NANDANKAN	09-Aug-16	Birth	White-coat colour
1697		F	20-Aug-16	UNK	UNK	VANVIHAR	16-Oct-15 20-Aug-16	Birth Death	Normal-coat colour
1698 JAI		M	26-Aug-16	1217	1556	LUCKNOW	26-Aug-16	Birth	White-coat colour
1699 VIJAY		M	26-Aug-16	1217	1556	LUCKNOW	26-Aug-16	Birth	White-coat colour
1700 KNPS13		M	????	WILD	WILD	INDIA INDORE	???? 30-Aug-16	Capture Transfer	Normal-coat colour
1701 SHAKTI		M	12-Nov-16	1158	1157	AURANGABA	12-Nov-16	Birth	Normal-coat colour
1702 BHAKTI		F	12-Nov-16	1158	1157	AURANGABA	12-Nov-16	Birth	Normal-coat colour
1703 VEER		M	12-Nov-16	1158	1157	AURANGABA	12-Nov-16	Birth	Normal-coat colour
1704 JULIYA		F	~ 2016	WILD	WILD	INDIA LUCKNOW	???? 19-Jan-17	Capture Transfer	Normal-coat colour
1706 NAVEDIYA		M	~ 2014	WILD	WILD	INDIA LUCKNOW	???? 12-Feb-17	Capture Transfer	Normal-coat colour
1707 TPAT38		M	13-Mar-17	1401	1483	PATNA	13-Mar-17 14-Mar-17	Birth Death	White-coat colour
1708 TPAT39		F	13-Mar-17	1401	1483	PATNA	13-Mar-17 16-Mar-17	Birth Death	White-coat colour
1709 TPAT40		F	13-Mar-17	1401	1483	PATNA	13-Mar-17 16-Mar-17	Birth Death	White-coat colour
1710 TPAT41		F	13-Mar-17	1401	1483	PATNA	13-Mar-17 20-Jul-17	Birth Death	White-coat colour
1711 BAGHI TPAT42		F	13-Mar-17	1401	1483	PATNA	13-Mar-17	Birth	White-coat colour
1712 VETAL 156		M	~ Jun 2005	WILD	WILD	INDIA NAINITAL	???? 01-Apr-17	Capture Transfer	Normal-coat colour
1713 AKHBAR CUBA		M	07-Apr-17	1516	1362	KANPUR	07-Apr-17	Birth	White-coat colour

National Stud# House Name LocalID Transponder	Int. Std. #	Sex	Birth Date	Sire	Dam	Location	Date	Event	Old NSB # Remarks
1714 ANTHONY CUBB		M	07-Apr-17	1516	1362	KANPUR	07-Apr-17	Birth	White-coat colour
1715 AMAR CUBC		M	07-Apr-17	1516	1362	KANPUR	07-Apr-17	Birth	White-coat colour
1716 AMBIKA CUBD		F	07-Apr-17	1516	1362	KANPUR	07-Apr-17	Birth	White-coat colour
1717		M	20-Aug-17	UNK	UNK	VANVIHAR	20-Aug-17 20-Aug-17	Birth Death	Normal- coat colour
1718 GOWRI M01346		F	~ 2008	WILD	WILD	KARNATAKA MYSORE	???? 09-Oct-17	Capture Transfer	Normal- coat colour
1719 TRISHIKA M01347		F	~ 2009	WILD	WILD	KARNATAKA MYSORE	???? 10-Oct-17	Capture Transfer	Normal- coat colour
1720 DHANUSH 00BT06		M	12-Mar-16	UNK	UNK	INDIA ASSAM	???? 12-Mar-18	Capture Transfer	Normal- coat colour
TOTALS: 785.872.40 (1697)									

Bengal Tigers (*Panthera tigris tigris*) Living in Indian Zoos

National Stud# House Name LocalID Transponder	Int. Std. #	Sex	Birth Date	Sire	Dam	Location	Date	Event	Old NSB # Remarks
Kamla Nehru Zoological Garden, Ahmedabad									
1274 ANANYA M00182 0006B71710	1596	F	06-Aug-02	719	825	MYSORE AHMEDABAD	06-Aug-02 12-Aug-08	Birth Transfer	U 427 White-coat colour
1376 PRATHAP M00181	1461	M	10-Apr-05	719	825	MYSORE AHMEDABAD	10-Apr-05 12-Aug-08	Birth Transfer	White-coat colour
Total: 1.1 (2)									
Assam State Zoo Cum Botanical Garden, Guwahati									
1384 BIPIN	1648	M	05-Nov-05	1335	991	ASSAM	05-Nov-05	Birth	Normal- coat colour
1457 BIRINA	1666	F	17-Aug-07	1335	991	ASSAM	17-Aug-07	Birth	Normal- coat colour
1479 KHUSHI 98102057846	1251	F	20-Oct-08	949	1154	NANDANKAN ASSAM	20-Oct-08 23-Aug-11	Birth Transfer	White-coat colour
1557 NANDINI 0006CDF46F		F	06-Jan-12	1351	1479	ASSAM	06-Jan-12	Birth	White-coat colour
1592 DURGA	1726	F	11-Dec-12	UNK	1479	ASSAM	11-Dec-12	Birth	White-coat colour
1619 KAZI		F	????	WILD	WILD	INDIA ASSAM	???? 22-Jan-14	Capture Transfer	Normal- coat colour
1720 DHANUSH 00BT06		M	12-Mar-16	UNK	UNK	INDIA ASSAM	???? 12-Mar-18	Capture Transfer	Normal- coat colour
Total: 2.5 (7)									
Aurangabad Municipal Zoo, Aurangabad									
963 RANI 0006CBEA63	967	F	06-Jun-96	684	733	AURANGABA	06-Jun-96	Birth	W 797 White-coat colour
1041 RAMU		M	15-Jan-98	684	733	AURANGABA	15-Jan-98	Birth	White-coat colour
1157 SAMRUDDHI 00750151E		F	06-Mar-00	1116	1388	AURANGABA	06-Mar-00	Birth	Normal- coat colour
1158 SIDDHARTH 0074D5B17		M	06-Mar-00	1116	1388	AURANGABA	06-Mar-00	Birth	Normal- coat colour
1171 GHANTI	1541	M	30-May-00	1026	1007	CHATBIR Z AURANGABA	30-May-00 04-Dec-05	Birth Transfer	Normal- coat colour
1327 SACHIN		M	18-Jan-04	1042	1044	AURANGABA	18-Jan-04	Birth	White-coat colour
1328 MANDIRA		F	18-Jan-04	1042	1044	AURANGABA	18-Jan-04	Birth	White-coat colour
1623 ARJOON 00074D4F0D		M	16-Feb-14	1158	1157	AURANGABA	16-Feb-14	Birth	Normal- coat colour
1672 KARISHAMA 0007153F36		F	22-Jul-15	1158	1506	AURANGABA	22-Jul-15	Birth	Normal- coat colour
1673 KAREENA 7153887		F	22-Jul-15	1158	1506	AURANGABA	22-Jul-15	Birth	Normal- coat colour
1701 SHAKTI		M	12-Nov-16	1158	1157	AURANGABA	12-Nov-16	Birth	Normal- coat colour

National Stud# House Name LocalID Transponder	Int. Std. #	Sex	Birth Date	Sire	Dam	Location	Date	Event	Old NSB # Remarks
1702 BHAkti		F	12-Nov-16	1158	1157	AURANGABA	12-Nov-16	Birth	Normal-coat colour
1703 VEER		M	12-Nov-16	1158	1157	AURANGABA	12-Nov-16	Birth	Normal-coat colour
Total: 7.6 (13)									
Bannerghatta Biological Park, Bangalore									
945 BHAVANI	1451	F	30-Jan-96	268	677	BANNERGHA	30-Jan-96	Birth	U 214 Normal-coat colour
946 YASHODA	1452	F	30-Jan-96	268	677	BANNERGHA	30-Jan-96	Birth	U 215 Normal-coat colour
972 GURU	1459	M	26-Jul-96	268	706	BANNERGHA	26-Jul-96	Birth	U 218 Normal-coat colour
973 BRAHMA	1460	F	26-Jul-96	268	706	BANNERGHA	26-Jul-96	Birth	U 219 Normal-coat colour
974 LAXHMI	1461	F	26-Jul-96	268	706	BANNERGHA	26-Jul-96	Birth	U 220 Normal-coat colour
1048 HARISHCHAND	1498	M	24-Mar-98	268	705	BANNERGHA	24-Mar-98	Birth	U 221 Normal-coat colour
1049 RAJESHWARI	1499	F	24-Mar-98	268	705	BANNERGHA	24-Mar-98	Birth	U 222 Normal-coat colour
1050 TEJASWANI	1500	F	24-Mar-98	268	705	BANNERGHA	24-Mar-98	Birth	U 223 Normal-coat colour
1063 KRISHNA	1505	M	22-Jul-98	268	841	BANNERGHA	22-Jul-98	Birth	U 224 Normal-coat colour
1079 LAVA	1515	M	31-Aug-98	268	678	BANNERGHA	31-Aug-98	Birth	U 233 Normal-coat colour
1081 GANGA	1517	F	31-Aug-98	268	678	BANNERGHA	31-Aug-98	Birth	U 235 Normal-coat colour
1082 GONA/GAURI	1518	F	31-Aug-98	268	678	BANNERGHA	31-Aug-98	Birth	U 236 Normal-coat colour
1105	1523	F	27-Feb-99	268	706	BANNERGHA	27-Feb-99	Birth	U 237 Normal-coat colour
1106 POOJA	1524	F	27-Feb-99	268	706	BANNERGHA	27-Feb-99	Birth	U 238 Normal-coat colour
1107 RAJA	1525	M	27-Feb-99	268	706	BANNERGHA	27-Feb-99	Birth	U 239 Normal-coat colour
1146 GOPAL		M	~ 1999	WILD	WILD	INDIA BANNERGHA	???? 18-Nov-14	Capture Transfer	Normal-coat colour
1183 KARTHIK	1546	M	04-Oct-00	972	841	BANNERGHA	04-Oct-00	Birth	Normal-coat colour
1184 MANASA	1547	F	04-Oct-00	972	841	BANNERGHA	04-Oct-00	Birth	Normal-coat colour
1244 MOHANA	1568	M	08-Jan-02	972	677	BANNERGHA	08-Jan-02	Birth	Normal-coat colour
1245 SINDHU	1569	F	08-Jan-02	972	677	BANNERGHA	08-Jan-02	Birth	Normal-coat colour

National Stud# House Name LocalID Transponder	Int. Std. #	Sex	Birth Date	Sire	Dam	Location	Date	Event	Old NSB # Remarks
1246 MENAKA	1570	F	08-Jan-02	972	677	BANNERGHA	08-Jan-02	Birth	Normal-coat colour
1247	1571	F	08-Jan-02	972	677	BANNERGHA	08-Jan-02	Birth	Normal-coat colour
1260 NAMRATHA	1583	M	18-Apr-02	597	946	BANNERGHA	18-Apr-02	Birth	Normal-coat colour
1261 RASHMI	1584	F	18-Apr-02	597	946	BANNERGHA	18-Apr-02	Birth	Normal-coat colour
1262 ROOPA	1585	F	18-Apr-02	597	946	BANNERGHA	18-Apr-02	Birth	Normal-coat colour
1263 TIPPU	1586	M	18-Apr-02	597	946	BANNERGHA	18-Apr-02	Birth	Normal-coat colour
1264 DRAVID	1587	M	19-Apr-02	623	706	BANNERGHA	19-Apr-02	Birth	White-coat colour
1265 BRADIS	1588	M	19-Apr-02	623	706	BANNERGHA	19-Apr-02	Birth	White-coat colour
1266 TANU	1589	F	19-Apr-02	623	706	BANNERGHA	19-Apr-02	Birth	White-coat colour
1267 GHANCI RANI	1590	F	19-Apr-02	623	706	BANNERGHA	19-Apr-02	Birth	White-coat colour
1268 MASTI M00184	1123	M	~ 1997	WILD	WILD	KARNATAKA MYSORE BANNERGHA	~ Jun 2002 07-Jun-02 11-Apr-05	Capture Transfer Transfer	889 Normal-coat colour
1270 KALPANA CHAWLA	1592	F	24-Jul-02	623	706	BANNERGHA	24-Jul-02	Birth	White-coat colour
1271 TENDULKAR	1593	M	24-Jul-02	623	706	BANNERGHA	24-Jul-02	Birth	White-coat colour
1347 ANU	1627	F	23-Jul-04	704	1184	BANNERGHA	23-Jul-04	Birth	Normal-coat colour
1419 MADHU	1692	M	25-Jun-07	1268	1184	BANNERGHA	25-Jun-07	Birth	Normal-coat colour
1420 VISMAYA	1693	F	25-Jun-07	1268	1184	BANNERGHA	25-Jun-07	Birth	Normal-coat colour
1458 AMAR		M	24-Aug-07	1265	1266	BANNERGHA	24-Aug-07	Birth	White-coat colour
1459 SURYA		M	24-Aug-07	1265	1266	BANNERGHA	24-Aug-07	Birth	White-coat colour
1460 VINAY	1694	M	24-Jan-08	1265	1266	BANNERGHA	24-Jan-08	Birth	White-coat colour
1461 SHREYAS	1695	M	24-Jan-08	1265	1266	BANNERGHA	24-Jan-08	Birth	White-coat colour
1462 SINDHU	1698	F	24-Jan-08	1265	1266	BANNERGHA	24-Jan-08	Birth	White-coat colour
1521 RAJAT 315	1708	M	25-Feb-11	UNK	UNK	BANNERGHA	25-Feb-11	Birth	Normal-coat colour
1578 MAHADESHA 9.56E+12 M00882	1737	M	~ Jun 2000	WILD	WILD	INDIA MYSORE BANNERGHA	~ 1 Aug 2012 26-Aug-12 15-Nov-12	Capture Transfer Transfer	Normal-coat colour
1650 JAWARA 317		M	12-Feb-09	WILD	WILD	INDIA BANNERGHA	???? 18-Nov-14	Capture Transfer	Normal-coat colour
Total: 22.22 (44)									
Bellary Zoo, Bellary									
1077 BHEEMA	1513	M	26-Aug-98	597	679	BELLARY	26-Aug-98	Birth	U 241 Normal-coat colour
Total: 1.0 (1)									
Maitri Baagh Zoo, Bhilai									
1411 SATPURA RAJA	1169	M	17-Jun-06	1136	755	BHILAI	17-Jun-06	Birth	Normal-coat colour

National Stud# House Name LocalID Transponder	Int. Std. #	Sex	Birth Date	Sire	Dam	Location	Date	Event	Old NSB # Remarks
1412 NANDI	1170	M	17-Jun-06	1136	755	BHILAI	17-Jun-06	Birth	Normal-coat colour
1422 GANGA	1173	F	08-Aug-06	1202	776	BHILAI	08-Aug-06	Birth	White-coat colour
1536 VASUNDHRA	1266	F	19-Jun-11	1411	1413	BHILAI	19-Jun-11	Birth	Normal-coat colour
1610 ROMA		F	15-Aug-13	1421	1422	BHILAI	15-Aug-13	Birth	White-coat colour
1616 GOPI		M	07-Dec-13	1202	1203	BHILAI	07-Dec-13	Birth	White-coat colour
1617 KISHAN		M	07-Dec-13	1202	1203	BHILAI	07-Dec-13	Birth	White-coat colour
1670 RAM		M	15-Jul-15	1421	1422	BHILAI	15-Jul-15	Birth	White-coat colour
1671 SHYAM		M	15-Jul-15	1421	1422	BHILAI	15-Jul-15	Birth	White-coat colour
1689 SONAM		F	04-Jul-16	1421	1422	BHILAI	04-Jul-16	Birth	White-coat colour
1690 SULTAN		M	04-Jul-16	1421	1422	BHILAI	04-Jul-16	Birth	White-coat colour
Total: 7.4 (11)									
Kanan Pandari Zoo, Bilaspur									
943 JWALA	1081	F	~ 1994	WILDB3	WILDB4	INDIA BILASPUR	08-Jan-96 14-Mar-96	Capture Transfer	884 Normal-coat colour
944 LAWA	1082	F	~ 1994	WILDB3	WILDB4	INDIA BILASPUR	08-Jan-96 14-Mar-96	Capture Transfer	886 Normal-coat colour
1443 SAMBO	1241	F	06-Feb-07	669	1221	DELHI BILASPUR	06-Feb-07 28-Jul-08	Birth Transfer	White-coat colour
Total: 0.3 (3)									
Jawaharlal Nehru Biological Park, Bokaro									
1069 RAJKUMAR	1015	M	26-Jul-98	761	776	BHILAI BOKARO	26-Jul-98 20-Jan-12	Birth Transfer	W 836 White-coat colour
1128 VISHNU	1042	M	05-Jul-99	650	755	BHILAI BOKARO	05-Jul-99 25-Aug-05	Birth Transfer	857 Normal-coat colour
1149 RANI	1054	F	23-Dec-99	794	512	BOKARO	23-Dec-99	Birth	868 White-coat colour
1150 PINKI	1055	F	23-Dec-99	794	512	BOKARO	23-Dec-99	Birth	869 White-coat colour
1151 MOHINI	1056	F	23-Dec-99	794	512	BOKARO	23-Dec-99	Birth	870 White-coat colour
1204 VIMLA	1096	F	11-Feb-01	761	776	BHILAI BOKARO	11-Feb-01 20-Jan-12	Birth Transfer	W 931 White-coat colour
Total: 2.4 (6)									
Sanjay Gandhi National Park And Zoo, Borivilli									
965 SIDDHARTH	978	M	06-Jun-96	684	733	AURANGABA BORIVILLI	06-Jun-96 25-Aug-98	Birth Transfer	W 805 White-coat colour
986 RABICA 006CBC6CC	977	F	21-Jan-97	684	733	AURANGABA BORIVILLI	21-Jan-97 02-Dec-10	Birth Transfer	W 804 White-coat colour
987 RENUKA	979	F	21-Jan-97	684	733	AURANGABA BORIVILLI	21-Jan-97 25-Aug-98	Birth Transfer	W 806 White-coat colour

National Stud# House Name LocalID Transponder	Int. Std. #	Sex	Birth Date	Sire	Dam	Location	Date	Event	Old NSB # Remarks
1172	1085	F	28-Jul-00	WILD	WILD	INDIA BORIVILLI	28-Jul-00 24-Oct-02	Capture Transfer	Normal- coat colour
1192 RAJIYA	1091	F	26-Nov-00	965	987	BORIVILLI	26-Nov-00	Birth	W 904 White-coat colour
1317 BAJIRAO	1207	M	20-Aug-03	965	987	BORIVILLI	20-Aug-03	Birth	White-coat colour
1318 ARYA	1208	M	20-Aug-03	965	987	BORIVILLI	20-Aug-03	Birth	White-coat colour
1319 MASTANI	1209	F	20-Aug-03	965	987	BORIVILLI	20-Aug-03	Birth	White-coat colour
1321 PALASH	1210	M	20-Sep-03	864	640	VANVIHAR BORIVILLI	20-Sep-03 07-Apr-06	Birth Transfer	White-coat colour
1475 YASH	1247	M	08-Oct-08	1321	1291	BORIVILLI	08-Oct-08	Birth	White-coat colour
1476 LAXMI	1248	F	08-Oct-08	1321	1291	BORIVILLI	08-Oct-08	Birth	White-coat colour
Total: 5.7 (12)									
Alipore Zoological Garden, Kolkatta									
956 SUNIL M00191	1455	M	22-Mar-96	268	595	BANNERGHA MYSORE CALCUTTA	22-Mar-96 10-Jul-96 23-Apr-05	Birth Transfer Transfer	U 385 Normal- coat colour
997 ANIRBAN	1475	M	28-Mar-97	373	613	CALCUTTA	28-Mar-97	Birth	WU 257 White-coat colour
1031 ANANYA	1496	F	16-Oct-97	373	613	CALCUTTA	16-Oct-97	Birth	WU 258 White-coat colour
1163 KRISHNA 28	1083	F	28-Mar-00	451	613	CALCUTTA	28-Mar-00	Birth	893 White-coat colour
1164 MEGHNA 29	1084	F	28-Mar-00	UNK	613	CALCUTTA	28-Mar-00	Birth	W 894 White-coat colour
1212 TEESTA 30	1100	F	18-Jun-01	451	613	CALCUTTA	18-Jun-01	Birth	909 White-coat colour
1350 RISHI	1217	M	01-Aug-04	757	847	NANDANKAN CALCUTTA	01-Aug-04 19-Feb-16	Birth Transfer	White-coat colour
1375	1640	F	04-Mar-05	997	1163	CALCUTTA	04-Mar-05	Birth	White-coat colour
1424	1644	M	08-Sep-06	997	1163	CALCUTTA	08-Sep-06	Birth	White-coat colour
1477 PAYAL 98102057603	1249	F	20-Oct-08	949	1154	NANDANKAN CALCUTTA	20-Oct-08 19-Feb-16	Birth Transfer	White-coat colour
1620 SHEELA		F	27-Jan-14	1276	1160	NANDANKAN CALCUTTA	27-Jan-14 19-Feb-16	Birth Transfer	White-coat colour
1638 SNEHASIS		F	28-Jul-14	1468	678	NANDANKAN CALCUTTA	28-Jul-14 19-Feb-16	Birth Transfer	White-coat colour
Total: 4.8 (12)									
Mahendra Chaudhury Zoological Park, Chatbir									
892 GYANO	1436	M	01-Mar-95	412	385	CHATBIR Z	01-Mar-95	Birth	U 313 Normal- coat colour
1008 JIMMY	1481	M	31-May-97	489	818	CHATBIR Z	31-May-97	Birth	U 323 Normal- coat colour
1248 APPAIAH	1572	M	08-Jan-02	972	677	BANNERGHA CHATBIR Z	08-Jan-02 16-Mar-11	Birth Transfer	Normal- coat colour
1269 PARAS	1591	M	23-Jun-02	1123	1124	LUDHIANA CHATBIR Z	23-Jun-02 28-May-08	Birth Transfer	Normal- coat colour

National Stud# House Name LocalID Transponder	Int. Std. #	Sex	Birth Date	Sire	Dam	Location	Date	Event	Old NSB # Remarks
1302 CHORNI	1606	F	11-Apr-03	1169	1185	CHATBIR Z LUDHIANA CHATBIR Z	11-Apr-03 20-Jan-05 28-May-08	Birth Transfer Transfer	Normal- coat colour
1311 DARA	1615	M	30-May-03	1026	818	CHATBIR Z	30-May-03	Birth	Normal- coat colour
1325 SAURABHA		M	18-Jan-04	1042	1044	AURANGABA CHATBIR Z	18-Jan-04 07-Dec-05	Birth Transfer	White-coat colour
1352 PRACHI	1219	F	01-Aug-04	757	847	NANDANKAN CHATBIR Z	01-Aug-04 11-Mar-12	Birth Transfer	White-coat colour
1414 LUCKY	1233	M	20-Jun-06	886	1219	DELHI CHATBIR Z	20-Jun-06 23-Mar-07	Birth Transfer	Normal- coat colour
1416	1235	F	20-Jun-06	886	1219	DELHI CHATBIR Z	20-Jun-06 23-Mar-07	Birth Transfer	Normal- coat colour
1464 CHIRAG	1668	M	14-Feb-08	1269	1302	LUDHIANA CHATBIR Z	14-Feb-08 28-May-08	Birth Transfer	Normal- coat colour
1465 PRITHVI	1669	M	14-Feb-08	1269	1302	LUDHIANA CHATBIR Z	14-Feb-08 28-May-08	Birth Transfer	Normal- coat colour
1507 CHITRA	1679	F	02-Apr-10	1414	1302	CHATBIR Z	02-Apr-10	Birth	White-coat colour
1570 AMAN		M	07-Jul-12	1337	1362	KANPUR CHATBIR Z	07-Jul-12 01-Feb-15	Birth Transfer	White-coat colour
Total: 10.4 (14)									
Padmaja Naidu Himalayan Zoological Park, Darjeeling									
1423 SAMRAT 244	1653	M	08-Sep-06	997	1163	CALCUTTA DARJEELIN	08-Sep-06 05-Jul-10	Birth Transfer	White-coat colour
Total: 1.0 (1)									
National Zoological Park, Delhi									
886 LAXMAN	934	M	09-Jan-95	511	307	NANDANKAN DELHI	09-Jan-95 18-Jul-99	Birth Transfer	W 663 White-coat colour
1009 KUNTI	1482	F	31-May-97	489	695	CHATBIR Z DELHI	31-May-97 17-Apr-01	Birth Transfer	U 324 Normal- coat colour
1061 PRIYA	1503	F	30-Jun-98	UNK	UNK	CHATBIR Z DELHI	30-Jun-98 17-Mar-01	Birth Transfer	U 333 Normal- coat colour
1208	1559	M	25-May-01	UNK	808	DELHI	25-May-01	Birth	Normal- coat colour
1344 RANI	1163	F	~ 1999	WILD	WILD	UTTARANCH NAINITAL DELHI	~27 Apr 2004 27-Apr-04 15-Mar-05	Capture Transfer Transfer	Normal- coat colour
1415	1234	M	20-Jun-06	886	1219	DELHI	20-Jun-06	Birth	Normal- coat colour
1417 VINA 260031	1236	F	20-Jun-06	886	1219	DELHI	20-Jun-06	Birth	Normal- coat colour
1418 VICKY	1237	M	21-Jun-06	886	1219	DELHI	21-Jun-06	Birth	Normal- coat colour
1444 AMBO	1242	F	06-Feb-07	669	1221	DELHI	06-Feb-07	Birth	White-coat colour
1455 VIJAY		M	21-Jul-07	886	1219	DELHI	21-Jul-07	Birth	White-coat colour
1529 M00666 9.56E+1229	1686	M	16-May-11	1470	1378	MYSORE DELHI	16-May-11 26-Mar-14	Birth Transfer	White-coat colour
1537 10021 260043	1778	M	~ 2009	WILD	WILD	BANDHAVG VANVIHAR DELHI	???? 10-Jul-11 20-Mar-14	Capture Transfer Transfer	Normal- coat colour

National Stud# House Name LocalID Transponder	Int. Std. #	Sex	Birth Date	Sire	Dam	Location	Date	Event	Old NSB # Remarks
1601 NAKULA M01055 00074D622F 260040	1724	M	04-Jun-13	1470	1378	MYSORE DELHI	04-Jun-13 26-Mar-14	Birth Transfer	White-coat colour
1657 TIPPU 260044 0006B7346C		M	18-Mar-15	1455	1444	DELHI	18-Mar-15	Birth	White-coat colour
1658 GEETA 260045		F	18-Mar-15	1455	1444	DELHI	18-Mar-15	Birth	White-coat colour
1659 260046		F	18-Mar-15	1455	1444	DELHI	18-Mar-15	Birth	White-coat colour
1660 260047		F	18-Mar-15	1455	1444	DELHI	18-Mar-15	Birth	White-coat colour
Total: 9.8 (17)									
Gandhi Zoological Park, Gwalior									
906 MONA 3KAN5	876	F	23-Apr-95	430	439	KANPUR GWALIOR	23-Apr-95 27-Sep-98	Birth Transfer	769 White-coat colour
1219 JAMUNA 260021	1107	F	05-Aug-01	886	744	DELHI GWALIOR	05-Aug-01 08-Feb-11	Birth Transfer	W 917 White-coat colour
Total: 0.2 (2)									
Nehru Zoological Park, Hyderabad									
625 RAJENDRA 1076	728	M	15-Jun-90	197	254	NANDANKAN HYDERABAD	15-Jun-90 22-Sep-00	Birth Transfer	W 486 Normal- coat colour
1016 KAVITHA	983	F	30-Jun-97	606	567	HYDERABAD	30-Jun-97	Birth	W 691 White-coat colour
1047 VINAY	1004	M	29-Jan-98	606	567	HYDERABAD	29-Jan-98	Birth	W 694 White-coat colour
1120 ROJA	1039	F	28-May-99	707	884	HYDERABAD	28-May-99	Birth	854 Normal- coat colour
1240 APARNA 10021	1120	F	13-Dec-01	625	567	HYDERABAD	13-Dec-01	Birth	934 White-coat colour
1339 KALPANA 10022		F	11-Apr-04	625	567	HYDERABAD	11-Apr-04	Birth	White-coat colour
1355 KUNAL	1630	M	26-Aug-04	510	950	HYDERABAD	26-Aug-04	Birth	White-coat colour
1395 BADRI 0006B71BCD		M	01-Apr-06	1290	1241	TIRUPATI HYDERABAD	01-Apr-06 05-Aug-11	Birth Transfer	White-coat colour
1397 BADRI 0006B71BCD	1228	M	01-Apr-06	1290	1241	TIRUPATI HYDERABAD	01-Apr-06 05-Aug-11	Birth Transfer	White-coat colour
1425 JO		M	20-Sep-06	1135	1240	HYDERABAD	20-Sep-06	Birth	White-coat colour
1428 SUREKHA 10032	1657	F	20-Sep-06	510	950	HYDERABAD	20-Sep-06	Birth	White-coat colour
1499 KADAMBA	1678	M	09-Nov-09	1256	1281	MANGALORE HYDERABAD	09-Nov-09 09-Nov-09	Birth Transfer	Normal- coat colour
1543 PRABHAS	1782	M	24-Sep-11	1401	1240	HYDERABAD	24-Sep-11	Birth	White-coat colour

National Stud# House Name LocalID Transponder	Int. Std. #	Sex	Birth Date	Sire	Dam	Location	Date	Event	Old NSB # Remarks
1544 SAIF	1784	M	24-Sep-11	1401	1240	HYDERABAD	24-Sep-11	Birth	White-coat colour
1561 ASHA		F	13-Jan-12	1350	1432	NANDANKAN HYDERABAD	13-Jan-12 09-Dec-16	Birth Transfer	White-coat colour
1580 SHARAN		M	20-Oct-12	1395	1428	HYDERABAD	20-Oct-12	Birth	White-coat colour
1581 KIRAN		M	20-Oct-12	1395	1428	HYDERABAD	20-Oct-12	Birth	White-coat colour
1611 DIVAYANI		F	06-Sep-13	1395	1428	HYDERABAD	06-Sep-13	Birth	White-coat colour
1612 DHARMA		M	06-Sep-13	1395	1428	HYDERABAD	06-Sep-13	Birth	White-coat colour
1613 DHANUSH		M	06-Sep-13	1395	1428	HYDERABAD	06-Sep-13	Birth	White-coat colour
1652 ABHIMANYU		M	02-Jan-15	1395	1428	HYDERABAD	02-Jan-15	Birth	White-coat colour
1685 KHAVI		M	23-Apr-16	1395	1428	HYDERABAD	23-Apr-16	Birth	White-coat colour
1686 NAGAMANI		F	23-Apr-16	1395	1428	HYDERABAD	23-Apr-16	Birth	White-coat colour
Total: 15.8 (23)									
Kamla Nehru Prani Sanghralaya Zoo, Indore									
895 LALOO 0006B823BF	881	M	06-Apr-95	450	658	INDORE	06-Apr-95	Birth	766 Normal- coat colour
896 BIHARI 0006B817DF	880	M	06-Apr-95	450	658	INDORE	06-Apr-95	Birth	767 Normal- coat colour
897 LUCKY	879	M	06-Apr-95	450	658	INDORE	06-Apr-95	Birth	768 Normal- coat colour
1024 KAMLESH 0006CD0B18	1492	F	05-Aug-97	489	695	CHATBIR Z AURANGABA INDORE	05-Aug-97 07-Dec-05 10-Aug-11	Birth Transfer Transfer	U 327 Normal- coat colour
1042 SHAMMU	1000	M	15-Jan-98	684	733	AURANGABA INDORE	15-Jan-98 05-May-08	Birth Transfer	W 823 White-coat colour
1044 SEETA	1002	F	15-Jan-98	684	733	AURANGABA INDORE	15-Jan-98 05-May-08	Birth Transfer	W 825 White-coat colour
1609 RAJAN		M	15-Aug-13	1421	1422	BHILAI INDORE	15-Aug-13 27-Nov-14	Birth Transfer	White-coat colour
1618 10022		M	~ 2009	UNK	UNK	VANVIHAR INDORE	???? 27-Dec-13	Capture Transfer	Normal- coat colour
1643 10034		M	05-Sep-14	1700	UNK	INDORE	05-Sep-14	Birth	Normal- coat colour
1653 DURGA		F	09-Jan-15	1618	UNK	INDORE	09-Jan-15	Birth	Normal- coat colour
1654 BAALI		M	09-Jan-15	1618	UNK	INDORE	09-Jan-15	Birth	Normal- coat colour
1700 KNPS13		M	????	WILD	WILD	INDIA INDORE	???? 30-Aug-16	Capture Transfer	Normal- coat colour
Total: 9.3 (12)									
Itanagar									
1323 TAKAR RBT12	1074	M	01-Jan-04	UNK	1090	ITANAGAR	01-Jan-04	Birth	Normal- coat colour
1433 NIGLO RBT16 9.81001E+1295	1152	M	29-Dec-06	UNK	1090	ITANAGAR	29-Dec-06	Birth	Normal- coat colour

National Stud# House Name LocalID Transponder	Int. Std. #	Sex	Birth Date	Sire	Dam	Location	Date	Event	Old NSB # Remarks
1434 TAGIA RBT15 9.61001E+1261	1151	M	29-Dec-06	UNK	1090	ITANAGAR	29-Dec-06	Birth	Normal-coat colour
1435 NANG RBT18 9.61001E+1265	1154	F	29-Dec-06	UNK	1090	ITANAGAR	29-Dec-06	Birth	Normal-coat colour
1593 CHIP1		F	~ 2012	WILD	WILD	INDIA ITANAGAR	13-Dec-12 28-Sep-13	Capture Transfer	Normal-coat colour
1594 IPRA		M	~ 2012	WILD	WILD	INDIA ITANAGAR	13-Dec-12 28-Sep-13	Capture Transfer	Normal-coat colour
Total: 4.2 (6)									
Nahargarh Biological Park, Jaipur									
1014 SITA	1487	F	26-Jun-97	584	585	KOTA JAIPUR	26-Jun-97 24-Jan-04	Birth Transfer	U 390 Normal-coat colour
1018 BHARAT	1489	M	02-Jul-97	592	593	KOTA JAIPUR	02-Jul-97 24-Jan-04	Birth Transfer	U 392 Normal-coat colour
1442 RAJA 260037	1240	M	06-Feb-07	669	1221	DELHI JAIPUR	06-Feb-07 21-Sep-15	Birth Transfer	White-coat colour
1482 NAHAR 9.81098E+12	58 1179	M	~ Jun 2005	WILD	WILD	MADHYA PR VANVIHAR JAIPUR	~ 8 Dec 2008 08-Dec-08 21-Mar-13	Capture Transfer Transfer	Normal-coat colour
Total: 3.1 (4)									
Machia Biological Park, Jodhpur									
998 SANDHYA	1465	F	????	UNK	UNK	UDAIPUR JODHPUR	???? 21-Apr-97	Birth Transfer	Normal-coat colour
Total: 0.1 (1)									
Sakkarbaug Zoo, Junagadh									
978 TOHIMA 3KAN7	972	F	30-Oct-96	430	439	KANPUR JUNAGADH	30-Oct-96 11-Nov-98	Birth Transfer	682 White-coat colour
980 AISHWARYA 3KAN8	974	F	30-Oct-96	430	439	KANPUR JUNAGADH	30-Oct-96 11-Nov-98	Birth Transfer	W 683 White-coat colour
1222 GANGA	1110	F	05-Aug-01	886	744	DELHI JUNAGADH	05-Aug-01 21-Sep-04	Birth Transfer	W 996 White-coat colour
1226 YAMUNA 10058		F	26-Sep-01	UNK	UNK	DELHI JUNAGADH	26-Sep-01 26-Sep-04	Birth Transfer	Normal-coat colour
1336 MOGALI 00-01BD-4039	1138	M	28-Mar-04	474	978	JUNAGADH	28-Mar-04	Birth	White-coat colour
1338 SRUSHTI 00-01BC-8AD3	1140	F	28-Mar-04	474	978	JUNAGADH	28-Mar-04	Birth	White-coat colour
1358 AMAR 00-0026-8EBF	1141	M	04-Oct-04	474	980	JUNAGADH	04-Oct-04	Birth	White-coat colour
1359 PRAKRUTI 00-01BD-8932	1142	F	04-Oct-04	474	980	JUNAGADH	04-Oct-04	Birth	White-coat colour
1389 SWET	1147	M	28-Feb-06	905	1222	JUNAGADH	28-Feb-06	Birth	White-coat colour
1392 HEER 000-01CE-C499	1150	F	28-Feb-06	905	1222	JUNAGADH	28-Feb-06	Birth	White-coat colour
Total: 3.7 (10)									

National Stud# House Name LocalID Transponder	Int. Std. #	Sex	Birth Date	Sire	Dam	Location	Date	Event	Old NSB # Remarks
Kanpur Zoo, Kanpur									
979 SUNNY 3KAN9	973	M	30-Oct-96	430	439	KANPUR	30-Oct-96	Birth	802 White-coat colour
1337 ABHAY 00-01BD-4039	1139	M	28-Mar-04	474	978	JUNAGADH KANPUR	28-Mar-04 02-Jan-10	Birth Transfer	White-coat colour
1362 TRUSHA 00-01BD-48F8	1145	F	12-Dec-04	905	1114	JUNAGADH KANPUR	12-Dec-04 02-Jan-10	Birth Transfer	White-coat colour
1516 PRASHANT	1204	M	~ Apr 2006	WILD	WILD	INDIA LUCKNOW KANPUR	~15 Oct 2010 15-Oct-10 24-Oct-10	Capture Transfer Transfer	Normal- coat colour
1533	1263	?	30-May-11	1337	1362	KANPUR	30-May-11	Birth	White-coat colour
1534	1264	?	30-May-11	1337	1362	KANPUR	30-May-11	Birth	White-coat colour
1535	1265	?	30-May-11	1337	1362	KANPUR	30-May-11	Birth	White-coat colour
1607 LUV		M	28-Jul-13	UNK	UNK	CHATBIR Z KANPUR	28-Jul-13 03-Feb-15	Birth Transfer	Normal- coat colour
1662 BADAL		M	05-May-15	1516	1362	KANPUR	05-May-15	Birth	White-coat colour
1669 BARKHA		F	23-May-15	1516	1362	KANPUR	23-May-15	Birth	White-coat colour
1713 AKHBAR CUBA		M	07-Apr-17	1516	1362	KANPUR	07-Apr-17	Birth	White-coat colour
1714 ANTHONY CUBB		M	07-Apr-17	1516	1362	KANPUR	07-Apr-17	Birth	White-coat colour
1715 AMAR CUBC		M	07-Apr-17	1516	1362	KANPUR	07-Apr-17	Birth	White-coat colour
1716 AMBIKA CUBD		F	07-Apr-17	1516	1362	KANPUR	07-Apr-17	Birth	White-coat colour
Total: 8.3.3 (14)									
Gadag Zoo, Gadag									
1481 ANUSUYA 0006B76068 M00080	1200	F	~15 Aug 2008	WILD	WILD	KARNATAKA MYSORE GADAG	~28 Oct 2008 28-Oct-08 05-Dec-17	Capture Transfer Transfer	Normal- coat colour
Total: 0.1 (1)									
Kota Zoo, Kota									
1019 SHATRUGAN	1490	M	02-Jul-97	592	593	KOTA	02-Jul-97	Birth	U 393 Normal- coat colour
1173 MANCHANDAN	1542	M	31-Jul-00	592	432	KOTA	31-Jul-00	Birth	U 400 Normal- coat colour
Total: 2.0 (2)									
Nawab Wazid Ali Shah Zoological Garden, Lucknow									
927 KANHA	887	M	30-Jun-91	WILD L1	WILD L2	MUKKI LUCKNOW	~ 1995 27-Sep-95	Capture Transfer	639 Normal- coat colour
1218 SWETA	1106	F	03-Jul-01	951	940	LUCKNOW	03-Jul-01	Birth	W 915 White-coat colour
1341 SISIRA	1213	M	24-Apr-04	859	848	NANDANKAN LUCKNOW	24-Apr-04 03-Oct-07	Birth Transfer	White-coat colour

National Stud# House Name LocalID Transponder	Int. Std. #	Sex	Birth Date	Sire	Dam	Location	Date	Event	Old NSB # Remarks
1349 IPSITA	1216	F	24-Jul-04	626	759	NANDANKAN LUCKNOW	24-Jul-04 03-Oct-07	Birth Transfer	White-coat colour
1487 KISHAN	1202	M	~ 2006	WILD	WILD	INDIA LUCKNOW	~ 2 Mar 2009 02-Mar-09	Capture Transfer	Normal- coat colour
1556 VISHAKHA		F	29-Nov-11	1421	1422	BHILAI LUCKNOW	29-Nov-11 19-Jul-14	Birth Transfer	White-coat colour
1569 KHIRI		M	15-Jun-12	WILD	WILD	LUCKNOW	15-Jun-12	Birth	Normal- coat colour
1596 MAILANI-1		F	15-Aug-12	WILD	WILD	INDIA LUCKNOW	???? 26-Feb-13	Capture Transfer	Normal- coat colour
1698 JAI		M	26-Aug-16	1217	1556	LUCKNOW	26-Aug-16	Birth	White-coat colour
1699 VIJAY		M	26-Aug-16	1217	1556	LUCKNOW	26-Aug-16	Birth	White-coat colour
1704 JULIYA		F	~ 2016	WILD	WILD	INDIA LUCKNOW	???? 19-Jan-17	Capture Transfer	Normal- coat colour
1706 NAVEDIYA		M	~ 2014	WILD	WILD	INDIA LUCKNOW	???? 12-Feb-17	Capture Transfer	Normal- coat colour
Total: 7.5 (12)									
Ludhiana Zoo, Ludhiana									
1123 PINTU	1521	M	????	UNK	UNK	LUDHIANA	????	Birth	Normal- coat colour
1124 RITA	1522	F	????	UNK	UNK	LUDHIANA	????	Birth	Normal- coat colour
1185 MISHU	1548	F	15-Nov-00	1008	1024	CHATBIR Z LUDHIANA	15-Nov-00 20-Jan-05	Birth Transfer	Normal- coat colour
1187 ELACHI	1550	F	15-Nov-00	1008	1024	CHATBIR Z LUDHIANA CHATBIR Z LUDHIANA	15-Nov-00 20-Jan-05 30-Jan-07 28-May-08	Birth Transfer Transfer Transfer	Normal- coat colour
1315 DEEPAK	1619	M	30-May-03	1026	1024	CHATBIR Z LUDHIANA	30-May-03 18-Jan-05	Birth Transfer	Normal- coat colour
Total: 2.3 (5)									
Maharaja Martand Singh Jeedo White Tiger Safari and Zoo, Rewa									
1454 PATTU 260033 10031	1243	F	21-Jul-07	886	1219	DELHI VANVIHAR REWA	21-Jul-07 21-Mar-14 08-Nov-15	Birth Transfer Transfer	White-coat colour
1555 RADHA		F	29-Nov-11	1421	1422	BHILAI REWA	29-Nov-11 05-Dec-15	Birth Transfer	White-coat colour
1608 RAGHU		M	15-Aug-13	1421	1422	BHILAI REWA	15-Aug-13 05-Dec-15	Birth Transfer	White-coat colour
1621 NAKUL 0007155DBA		M	16-Feb-14	1158	1157	AURANGABA REWA	16-Feb-14 16-Jan-16	Birth Transfer	Normal- coat colour
1622 DURGA 00071539F8		F	16-Feb-14	1158	1157	AURANGABA REWA	16-Feb-14 16-Jan-16	Birth Transfer	Normal- coat colour
Total: 2.3 (5)									
Arignar Anna Zoological Park, Chennai									
1294 VIJAY 100163	1136	M	01-Feb-03	707	894	VISAKAPAT MADRAS	01-Feb-03 10-Aug-07	Birth Transfer	954 Normal- coat colour
1371 BHISMA 100181	1221	M	14-Feb-05	886	1219	DELHI MADRAS	14-Feb-05 30-Sep-06	Birth Transfer	White-coat colour
1380 ANU 260027 100182	1162	F	20-Jun-05	669	1221	DELHI MADRAS	20-Jun-05 30-Sep-06	Birth Transfer	White-coat colour

National Stud# House Name LocalID Transponder	Int. Std. #	Sex	Birth Date	Sire	Dam	Location	Date	Event	Old NSB # Remarks
1490 AKANSHA 100183	1730	F	24-Mar-09	1371	1380	MADRAS	24-Mar-09	Birth	White-coat colour
1491 NAMRUTHA 100184	1731	F	24-Mar-09	1371	1380	MADRAS	24-Mar-09	Birth	White-coat colour
1514 INDIRA AAZP7	1733	F	06-Jun-10	1371	1380	MADRAS	06-Jun-10	Birth	White-coat colour
1582 ARJUNA 100437	1793	M	23-Oct-12	1371	1380	MADRAS	23-Oct-12	Birth	White-coat colour
1583 ATHAYA 100438	1794	M	23-Oct-12	1371	1380	MADRAS	23-Oct-12	Birth	White-coat colour
1584 CAUVERY 100439	1795	F	23-Oct-12	1371	1380	MADRAS	23-Oct-12	Birth	White-coat colour
1588 NETHRA 100434	1797	F	07-Nov-12	1294	1490	MADRAS	07-Nov-12	Birth	White-coat colour
1589 VIDHYA 100435	1798	F	07-Nov-12	1294	1490	MADRAS	07-Nov-12	Birth	White-coat colour
1590 ARTHI 100436	1799	F	07-Nov-12	1294	1490	MADRAS	07-Nov-12	Birth	White-coat colour
1614 UTHIRA 100532	1785	F	~ Dec 2013	WILD	WILD	INDIA MADRAS	~ 1 Sep 2014 24-Sep-14	Capture Transfer	Normal- coat colour
1632 ADHITHIYA 100530	1801	M	23-Mar-14	1294	1491	MADRAS	23-Mar-14	Birth	White-coat colour
1633 KARNA 100531	1800	M	23-Mar-14	1294	1491	MADRAS	23-Mar-14	Birth	White-coat colour
1644 ANITHA 100533	1803	F	12-Sep-14	1294	1490	MADRAS	12-Sep-14	Birth	White-coat colour
1645 PRITHA 100534	1804	F	12-Sep-14	1294	1490	MADRAS	12-Sep-14	Birth	White-coat colour
1646 SUNITHA 100535	1805	F	12-Sep-14	1294	1490	MADRAS	12-Sep-14	Birth	White-coat colour
1647 SANGEETHA 100536	1806	F	12-Sep-14	1294	1490	MADRAS	12-Sep-14	Birth	White-coat colour
1675 NAGULA 100572		M	16-Oct-15	1294	1491	MADRAS	16-Oct-15	Birth	White-coat colour
1676 KALAM 100573		F	16-Oct-15	1294	1491	MADRAS	16-Oct-15	Birth	White-coat colour
1677 DEVAM 100571		M	16-Oct-15	1294	1491	MADRAS	16-Oct-15	Birth	White-coat colour
1678 MALA 100574		F	16-Oct-15	1294	1491	MADRAS	16-Oct-15	Birth	White-coat colour
Total: 8.15 (23)									
Dr. K.Shivarma Karanth Pililkula Biological Park, Mangalore									

National Stud# House Name LocalID Transponder	Int. Std. #	Sex	Birth Date	Sire	Dam	Location	Date	Event	Old NSB # Remarks
990 RAJA 9.81098E+1232	1468	M	28-Jan-97	680	835	SHIMOGA MANGALORE	28-Jan-97 25-Nov-03	Birth Transfer	U 359 Normal- coat colour
1254 PULAKESHI	1188	M	20-Feb-02	680	681	SHIMOGA MANGALORE	20-Feb-02 23-Nov-06	Birth Transfer	Normal- coat colour
1256 VIKRAM 9.81098E+1205 100001	1190	M	20-Feb-02	680	681	SHIMOGA MANGALORE	20-Feb-02 25-Nov-03	Birth Transfer	Normal- coat colour
1257 VANAMALA	1191	F	20-Feb-02	680	681	SHIMOGA MANGALORE	20-Feb-02 23-Nov-06	Birth Transfer	Normal- coat colour
1281 VARADHA 9.81098E+1206	1600	F	16-Sep-02	680	991	SHIMOGA MANGALORE	16-Sep-02 23-Nov-03	Birth Transfer	U 431 Normal- coat colour
1449 KUMARA	1663	M	29-Jun-07	1254	1281	MANGALORE	29-Jun-07	Birth	Normal- coat colour
1450 SHAMBHAVI 100005	1664	F	29-Jun-07	1254	1281	MANGALORE	29-Jun-07	Birth	Normal- coat colour
1451 NETHRAVATHY 100006	1665	F	29-Jun-07	1254	1281	MANGALORE	29-Jun-07	Birth	Normal- coat colour
1586 OLIVER 100134		M	05-Nov-12	1256	1481	MANGALORE	05-Nov-12	Birth	Normal- coat colour
1629 MANJU 100159		M	04-Mar-14	1256	1451	MANGALORE	04-Mar-14	Birth	Normal- coat colour
1630 AKASHAYA 100158	1768	M	04-Mar-14	1256	1451	MANGALORE	04-Mar-14	Birth	Normal- coat colour
1631 MANJU 100159	1769	M	04-Mar-14	1256	1451	MANGALORE	04-Mar-14	Birth	Normal- coat colour
1679 AMAR 100184		M	19-Mar-16	1256	1451	MANGALORE	19-Mar-16	Birth	Normal- coat colour
1680 AKBAR 100185		M	19-Mar-16	1256	1451	MANGALORE	19-Mar-16	Birth	Normal- coat colour
1681 ANTONY 100186		M	19-Mar-16	1256	1451	MANGALORE	19-Mar-16	Birth	Normal- coat colour
1682 100187		M	19-Mar-16	1256	1451	MANGALORE	19-Mar-16	Birth	Normal- coat colour
Total: 12.4 (16)									
Sri Chamarajendra Zoological Gardens, Mysore									
1242	1566	F	05-Jan-02	719	825	MYSORE	05-Jan-02	Birth	U 413 White-coat colour
1243	1567	M	05-Jan-02	719	825	MYSORE	05-Jan-02	Birth	U 414 White-coat colour
1273 AGASTHYA M00084 0006B757FB	1595	M	06-Aug-02	719	825	MYSORE	06-Aug-02	Birth	U 426 White-coat colour
1275 AMULYA M00077 0006B7E207	1597	M	06-Aug-02	719	825	MYSORE	06-Aug-02	Birth	U 428 White-coat colour

National Stud# House Name LocalID Transponder	Int. Std. #	Sex	Birth Date	Sire	Dam	Location	Date	Event	Old NSB # Remarks
1378 MANYA M00076 000-6B74-A9D	1643	F	10-Apr-05	719	825	MYSORE	10-Apr-05	Birth	White-coat colour
1470 BRAHMA 0006B73ADA M00072	1198	M	~ 2000	WILD	WILD	KARNATAKA MYSORE	17-Mar-08 18-Mar-08	Capture Transfer	Normal-coat colour
1520 RAHUL M01167	1765	M	~ Jan 2011	WILD	WILD	KARNATAKA MYSORE	~ Jan 2011 09-Jul-15	Capture Transfer	Normal-coat colour
1591 9.56E+12QT11	1269	F	~ Sep 2009	WILD	WILD	INDIA MYSORE	???? 04-Dec-12	Capture Transfer	Normal-coat colour
1598 MRUTHYUNJAY M01053 A00074D6A59	1722	M	04-Jun-13	1470	1378	MYSORE	04-Jun-13	Birth	White-coat colour
1599 VAYAPUTRA M01054 00071541F3	1723	M	04-Jun-13	1470	1378	MYSORE	04-Jun-13	Birth	White-coat colour
1600 PRUTHVI M01056 00074C47F4	1725	M	04-Jun-13	1470	1378	MYSORE	04-Jun-13	Birth	White-coat colour
1615 SHIVA 9.56E+1209 M01089	1272	M	~ Apr 2002	WILD	WILD	KARNATAKA MYSORE	???? 05-Dec-13	Capture Transfer	Normal-coat colour
1642 OKKANNA M01130		M	~ Feb 2005	WILD	WILD	KARNATAKA MYSORE	???? 05-Sep-14	Capture Transfer	Normal-coat colour
1651 RAMYA M01151	1740	F	~ Apr 2005	WILD	WILD	KARNATAKA MYSORE	???? 17-Dec-14	Capture Transfer	Normal-coat colour
1688 M01301		M	~ Jun 2016	WILD	WILD	INDIA MYSORE	???? 27-Mar-17	Capture Transfer	Normal-coat colour
1718 GOWRI M01346		F	~ 2008	WILD	WILD	KARNATAKA MYSORE	???? 09-Oct-17	Capture Transfer	Normal-coat colour
1719 TRISHIKA M01347		F	~ 2009	WILD	WILD	KARNATAKA MYSORE	???? 10-Oct-17	Capture Transfer	Normal-coat colour
Total: 11.6 (17)									
Pt. Govind Ballabh Pant High Altitude Zoo, Nainital									
1452 RANI 77	1199	F	15-Jun-07	WILD	WILD	INDIA NAINITAL	???? 10-Jul-08	Capture Transfer	Normal-coat colour
1500 77		F	~ 2006	WILD	WILD	INDIA NAINITAL	???? ~ 2010	Capture Transfer	Normal-coat colour
1712 VETAL 156		M	~ Jun 2005	WILD	WILD	INDIA NAINITAL	???? 01-Apr-17	Capture Transfer	Normal-coat colour
Total: 1.2 (3)									
Nandankanan Biological Park Bhubaneswar									
1083 JAGAT	1019	M	15-Sep-98	513	435	NANDANKAN	15-Sep-98	Birth	W 840 White-coat colour
1127 REBATI	1206	F	03-Jul-99	757	847	NANDANKAN	03-Jul-99	Birth	891 White-coat colour

National Stud# House Name LocalID Transponder	Int. Std. #	Sex	Birth Date	Sire	Dam	Location	Date	Event	Old NSB # Remarks
1155 KISSAN 300	1060	M	28-Dec-99	639	476	NANDANKAN	28-Dec-99	Birth	W 874 White-coat colour
1160 PRIYANKA	1062	F	25-Mar-00	859	848	NANDANKAN	25-Mar-00	Birth	876 White-coat colour
1276 ROSHAN 98102058095	1125	M	05-Sep-02	639	476	NANDANKAN	05-Sep-02	Birth	943 White-coat colour
1432 SARA 9.81098E+1214	1176	F	~ May 2006	WILD	WILD	MADHYA PR VANVIHAR NANDANKAN	~18 Oct 2006 18-Oct-06 18-Apr-09	Capture Transfer Transfer	Normal- coat colour
1468 MANISH 98102056660	1245	M	28-Feb-08	757	847	NANDANKAN	28-Feb-08	Birth	White-coat colour
1469 RENUKA 98102055402	1246	F	28-Feb-08	757	847	NANDANKAN	28-Feb-08	Birth	White-coat colour
1501	1258	F	01-Mar-10	949	1154	NANDANKAN	01-Mar-10	Birth	White-coat colour
1503 SAMRAT	1257	M	01-Mar-10	949	1154	NANDANKAN	01-Mar-10	Birth	White-coat colour
1504 SNEHA	1255	F	01-Mar-10	949	1154	NANDANKAN	01-Mar-10	Birth	White-coat colour
1538 RAGINI	1267	F	13-Jul-11	949	1154	NANDANKAN	13-Jul-11	Birth	White-coat colour
1539 BIJAYA	1268	F	13-Jul-11	949	1154	NANDANKAN	13-Jul-11	Birth	White-coat colour
1548		M	16-Nov-11	1276	1160	NANDANKAN	16-Nov-11	Birth	White-coat colour
1549		M	16-Nov-11	1276	1160	NANDANKAN	16-Nov-11	Birth	White-coat colour
1551		F	16-Nov-11	1276	1160	NANDANKAN	16-Nov-11	Birth	White-coat colour
1562 ANKITA		F	13-Jan-12	1350	1432	NANDANKAN	13-Jan-12	Birth	White-coat colour
1563 SUBHASHREE		F	13-Jan-12	1350	1432	NANDANKAN	13-Jan-12	Birth	White-coat colour
1602 NANDAN		M	07-Jul-13	WILD	WILD	NANDANKAN	07-Jul-13	Birth	Normal- coat colour
1636 SUBHRANSU		M	28-Jul-14	1468	678	NANDANKAN	28-Jul-14	Birth	White-coat colour
1637 KRISHNA		M	28-Jul-14	1468	678	NANDANKAN	28-Jul-14	Birth	White-coat colour
1639 ANINI		M	28-Jul-14	1468	678	NANDANKAN	28-Jul-14	Birth	White-coat colour
1683 BAHUBALI		M	20-Apr-16	1602	706	NANDANKAN	20-Apr-16	Birth	Normal- coat colour
1684 KUNDAN		M	20-Apr-16	1602	706	NANDANKAN	20-Apr-16	Birth	Normal- coat colour
1692 VICKY TC3		M	05-Aug-16	1468	678	NANDANKAN	05-Aug-16	Birth	White-coat colour
1693 CHINU TC4		M	05-Aug-16	1468	678	NANDANKAN	05-Aug-16	Birth	White-coat colour
1694 MOUSUMI TC5		F	05-Aug-16	1468	678	NANDANKAN	05-Aug-16	Birth	White-coat colour
1695 SAHIL		M	09-Aug-16	1276	UNK	NANDANKAN	09-Aug-16	Birth	White-coat colour

National Stud# House Name LocalID Transponder	Int. Std. #	Sex	Birth Date	Sire	Dam	Location	Date	Event	Old NSB # Remarks
1696 ADYASHA		F	09-Aug-16	1276	UNK	NANDANKAN	09-Aug-16	Birth	White-coat colour
Total: 16.13 (29)									
Sanjay Gandhi Biological Park, Patna									
1401 BHEEMA 10025 TPAT28	1232	M	14-Apr-06	1135	860	HYDERABAD PATNA	14-Apr-06 12-Aug-11	Birth Transfer	White-coat colour
1483 SWARNA TPAT30	1772	F	02-Jan-09	1290	1241	TIRUPATI PATNA	02-Jan-09 12-Aug-11	Birth Transfer	White-coat colour
1625 RAJA TPAT34		M	04-Mar-14	1401	1483	PATNA	04-Mar-14	Birth	White-coat colour
1626 BHAWANI TPAT35		F	04-Mar-14	1401	1483	PATNA	04-Mar-14	Birth	White-coat colour
1627 DEVI TPAT36		F	04-Mar-14	1401	1483	PATNA	04-Mar-14	Birth	White-coat colour
1711 BAGHI TPAT42		F	13-Mar-17	1401	1483	PATNA	13-Mar-17	Birth	White-coat colour
Total: 2.5 (7)									
Rajiv Gandhi Zoological Park And Wildlife Research Center, Pune									
1191 Priyadarshi 000-63D-E55E	1090	F	26-Nov-00	965	987	BORIVILLI PUNE	26-Nov-00 20-Dec-06	Birth Transfer	W 903 White-coat colour
1332 TANAJI 000-6A27-D63	1622	M	01-Feb-04	771	993	PUNE	01-Feb-04	Birth	Normal- coat colour
1333 NANDINI 000-6A2A-2E2	1623	F	01-Feb-04	771	993	PUNE	01-Feb-04	Birth	Normal- coat colour
1506 RIDDHI 0007503D88		F	06-Mar-10	1116	1388	AURANGABA PUNE	06-Mar-10 11-Apr-15	Birth Transfer	Normal- coat colour
1649 BAGIRAM 10184	1786	M	~ Jul 2009	WILD	WILD	INDIA PUNE	~ 1 Sep 2014 16-Sep-14	Capture Transfer	Normal- coat colour
Total: 2.3 (5)									
Nandanvan Jungle Safari (Naya Raipur), Raipur									
1383 RAGINI 0006B75236	1647	F	05-Nov-05	1335	991	ASSAM RAIPUR	05-Nov-05 01-Sep-12	Birth Transfer	Normal- coat colour
1519 SIVAJI	1682	M	29-Oct-10	1335	991	ASSAM RAIPUR	29-Oct-10 ????	Birth Transfer	Normal- coat colour
1571 CHITRA		F	07-Jul-12	1337	1362	KANPUR RAIPUR	07-Jul-12 11-Aug-16	Birth Transfer	White-coat colour
1688 M01301		M	~ Jun 2016	WILD	WILD	INDIA MYSORE	???? 27-Mar-17	Capture Transfer	Normal- coat colour
Total: 2.2 (4)									
Rajkot Zoo, Rajkot									
1390 DHAVAL 0001CDDA9F	1148	M	28-Feb-06	905	1222	JUNAGADH RAJKOT	28-Feb-06 25-Jun-15	Birth Transfer	White-coat colour
1406 BHOOMI 000-6CC-10-AB	1166	F	21-May-06	734	1113	VADODARA RAJKOT	21-May-06 18-Jul-10	Birth Transfer	White-coat colour
1523 DHARA	1683	F	04-Apr-11	1168	1113	RAJKOT	04-Apr-11	Birth	White-coat colour

National Stud# House Name LocalID Transponder	Int. Std. #	Sex	Birth Date	Sire	Dam	Location	Date	Event	Old NSB # Remarks
1530 DIWAKAR 00074D6238	1260	M	16-May-11	1202	1203	BHILAI RAJKOT	16-May-11 19-Nov-14	Birth Transfer	White-coat colour
1531 GAYATRI 00074C86EE	1261	F	16-May-11	1202	1203	BHILAI RAJKOT	16-May-11 19-Nov-14	Birth Transfer	White-coat colour
1532 YASHODHRA 00074D5836	1262	F	16-May-11	1202	1203	BHILAI RAJKOT	16-May-11 19-Nov-14	Birth Transfer	White-coat colour
1664 00074D399B		F	16-May-15	1530	1531	RAJKOT	16-May-15	Birth	White-coat colour
1665 00074D421B		F	16-May-15	1530	1531	RAJKOT	16-May-15	Birth	White-coat colour
1666 00074CA290		F	16-May-15	1530	1531	RAJKOT	16-May-15	Birth	White-coat colour
1667 7.15E+05		F	16-May-15	1530	1531	RAJKOT	16-May-15	Birth	White-coat colour
Total: 2.9 (11)									
Bhagwan Birsa Biological Park, Ranchi									
1526 SHIVA		M	11-May-11	1244	1246	BANNERGHA RANCHI	11-May-11 24-Nov-14	Birth Transfer	Normal- coat colour
1545 ANUSHKA 230040 TIGER7		F	24-Oct-11	1401	1240	HYDERABAD RANCHI	24-Oct-11 27-Feb-16	Birth Transfer	White-coat colour
1597 MALLIK		M	21-May-13	1135	1240	HYDERABAD RANCHI	21-May-13 01-Mar-16	Birth Transfer	White-coat colour
Total: 2.1 (3)									
Tiger & Lion Safari, Shimoga									
992 KRUTHIKA	1470	F	28-Jan-97	680	835	SHIMOGA	28-Jan-97	Birth	U 361 Normal- coat colour
1102	1032	F	24-Nov-98	680	913	SHIMOGA	24-Nov-98	Birth	850 Normal- coat colour
1227 SHREYA	1563	F	08-Oct-01	UNK	992	SHIMOGA	08-Oct-01	Birth	U 411 Normal- coat colour
1249 LAVA	1573	M	19-Feb-02	990	835	SHIMOGA	19-Feb-02	Birth	U 415 Normal- coat colour
1250 KUSHA	1574	M	19-Feb-02	990	835	SHIMOGA	19-Feb-02	Birth	U 416 Normal- coat colour
1299 VALI	1603	M	16-Feb-03	680	992	SHIMOGA	16-Feb-03	Birth	Normal- coat colour
1300 HANUMAN	1604	F	16-Feb-03	680	992	SHIMOGA	16-Feb-03	Birth	Normal- coat colour
1386 RAM	1650	M	23-Nov-05	680	835	SHIMOGA	23-Nov-05	Birth	Normal- coat colour
1387 BHARATHA	1651	M	23-Nov-05	680	835	SHIMOGA	23-Nov-05	Birth	Normal- coat colour
1445 SEETHA	1662	F	25-Mar-07	1249	992	SHIMOGA	25-Mar-07	Birth	Normal- coat colour
1497 VIJAY	1676	M	16-Oct-09	1249	992	SHIMOGA	16-Oct-09	Birth	Normal- coat colour
1498 DASHAMI	1677	M	16-Oct-09	1249	992	SHIMOGA	16-Oct-09	Birth	Normal- coat colour
Total: 7.5 (12)									
Dr. Shyamprasad Mukharjee Zoological Garden, Surat									

National Stud# House Name LocalID Transponder	Int. Std. #	Sex	Birth Date	Sire	Dam	Location	Date	Event	Old NSB # Remarks
976 MONGHI	899	F	26-Sep-96	530	730	RAJKOT SURAT	26-Sep-96 14-Apr-02	Birth Transfer	677 White-coat colour
1112 RIDHI	900	F	14-Mar-99	530	730	RAJKOT SURAT	14-Mar-99 10-Apr-02	Birth Transfer	718 White-coat colour
1546 KRISHNA 100118	1687	M	09-Nov-11	1256	1451	MANGALORE SURAT	09-Nov-11 07-Apr-14	Birth Transfer	Normal- coat colour
Total: 1.2 (3)									
Tata Steel Zoological Park, Jamshedpur									
1045 REETA 0006CC3D21	1003	F	15-Jan-98	684	733	AURANGABA TATA	15-Jan-98 09-Dec-10	Birth Transfer	W 826 White-coat colour
1147 SHANTI 0006B71522	1533	F	22-Dec-99	803	767	TATA	22-Dec-99	Birth	U 335 Normal- coat colour
1382 RAGHAB 0006B7640F	1646	M	05-Nov-05	1335	991	ASSAM TATA	05-Nov-05 24-Mar-10	Birth Transfer	Normal- coat colour
1511 KAILASH 9.56E+12	1744	M	02-May-10	1290	1241	TIRUPATI TATA	02-May-10 02-Mar-14	Birth Transfer	White-coat colour
1565 DONA 0006B71DOE		F	16-Apr-12	1382	1147	TATA	16-Apr-12	Birth	Normal- coat colour
1640 VIVAAN 000757DACE		M	28-Aug-14	1382	1147	TATA	28-Aug-14	Birth	Normal- coat colour
1641 AHANA 000757F723		F	28-Aug-14	1382	1147	TATA	28-Aug-14	Birth	Normal- coat colour
Total 3.4 (7)									
Sri Venkateswara Zoological Park, Tirupati									
910 BADAL 0006B744C3	936	M	09-Jun-95	639	476	NANDANKAN VISAKAPAT TIRUPATI	09-Jun-95 22-Sep-00 17-Dec-00	Birth Transfer Transfer	771 White-coat colour
1176 RAMYA 0006B75070	1088	F	03-Aug-00	339	894	VISAKAPAT TIRUPATI	03-Aug-00 21-Dec-12	Birth Transfer	898 Normal- coat colour
1241 HASINA 0006B72ED6 M19W02	1121	F	13-Dec-01	625	567	HYDERABAD TIRUPATI	13-Dec-01 06-Mar-05	Birth Transfer	W 934 White-coat colour
1290 RANDEER 0006B73B65 M19W01	1134	M	19-Nov-02	911	950	HYDERABAD TIRUPATI	19-Nov-02 06-Mar-05	Birth Transfer	W 952 White-coat colour
1354 KEERTHI 230026 M20W15	1629	F	26-Aug-04	510	950	HYDERABAD TIRUPATI	26-Aug-04 08-Aug-11	Birth Transfer	White-coat colour
1396 MOHAN 0006B72D55	1227	M	01-Apr-06	1290	1241	TIRUPATI	01-Apr-06	Birth	White-coat colour
1398 GANGA 0006B71A7A	1229	F	01-Apr-06	1290	1241	TIRUPATI	01-Apr-06	Birth	White-coat colour
1427 SAMEER 10030	1656	M	20-Sep-06	510	950	HYDERABAD TIRUPATI	20-Sep-06 08-Aug-11	Birth Transfer	White-coat colour

National Stud# House Name LocalID Transponder	Int. Std. #	Sex	Birth Date	Sire	Dam	Location	Date	Event	Old NSB # Remarks
1474 RAMYA M13-04	1770	F	~ 2008	UNK	UNK	INDIA TIRUPATI	~ 2008 21-Dec-12	Birth Transfer	Normal- coat colour
1510 RANI M20W13	1775	F	02-May-10	1290	1241	TIRUPATI	02-May-10	Birth	White-coat colour
1566 KRISHNA M20W16	1787	M	02-May-12	1290	1241	TIRUPATI	02-May-12	Birth	White-coat colour
1567 BALARAM M20W17	1788	M	02-May-12	1290	1241	TIRUPATI	02-May-12	Birth	White-coat colour
1568 SUBHADRA M20W18	1789	F	02-May-12	1290	1241	TIRUPATI	02-May-12	Birth	White-coat colour
Total: 6.7 (13)									
Thrissur									
1303 14	1607	M	11-May-03	538	1001	TRIVANDRU TRICHUR	11-May-03 21-Jun-09	Birth Transfer	Normal- coat colour
Total: 1.0 (1)									
Thiruvananthapuram Zoo, Thiruvananthapuram									
1001 KARISHMA M00197	1477	F	09-May-97	272	608	MYSORE TRIVANDRU	09-May-97 11-Dec-01	Birth Transfer	U 209 Normal- coat colour
1304 RAVI	1608	M	11-May-03	538	1001	TRIVANDRU	11-May-03	Birth	U 432 Normal- coat colour
1305 RAHUL	1609	M	11-May-03	538	1001	TRIVANDRU	11-May-03	Birth	U 433 Normal- coat colour
1306 RESMY	1610	F	11-May-03	538	1001	TRIVANDRU	11-May-03	Birth	U 434 Normal- coat colour
1345 KIRAN	1625	M	12-Jul-04	538	1001	TRIVANDRU	12-Jul-04	Birth	Normal- coat colour
1346 KARTHIKA	1626	F	12-Jul-04	538	1001	TRIVANDRU	12-Jul-04	Birth	Normal- coat colour
1437 MANIKANTAN	1659	M	13-Jan-07	1345	1001	TRIVANDRU	13-Jan-07	Birth	Normal- coat colour
1438 PONNU	1660	F	13-Jan-07	1345	1001	TRIVANDRU	13-Jan-07	Birth	Normal- coat colour
1439 MANNU	1661	M	13-Jan-07	1345	1001	TRIVANDRU	13-Jan-07	Birth	Normal- coat colour
1453 NZP 260034	1244	F	21-Jul-07	UNK	1219	DELHI TRIVANDRU	21-Jul-07 14-Oct-14	Birth Transfer	White-coat colour
1624 SHRWAN 260042	1727	M	20-Feb-14	1455	1444	DELHI TRIVANDRU	20-Feb-14 14-Oct-14	Birth Transfer	White-coat colour
Total: 6.5 (11)									
Sajjangarh Biological Park, Udaipur									
844 RADHA	1422	F	21-Nov-93	387	432	KOTA UDAIPUR	21-Nov-93 11-Jul-00	Birth Transfer	U 380 Normal- coat colour
845 RUKMANI	1423	F	21-Nov-93	387	432	KOTA UDAIPUR	21-Nov-93 11-Jul-00	Birth Transfer	U 381 Normal- coat colour
1334 DAMINI 000-6A2A-D56	1624	F	01-Feb-04	771	993	PUNE UDAIPUR	01-Feb-04 07-Feb-15	Birth Transfer	Normal- coat colour

National Stud# House Name LocalID Transponder	Int. Std. #	Sex	Birth Date	Sire	Dam	Location	Date	Event	Old NSB # Remarks
1540 RAMA 100363		M	03-Aug-11	1371	1380	MADRAS UDAIPUR	03-Aug-11 25-Sep-16	Birth Transfer	White-coat colour
Total: 1.3 (4)									
Vadodra									
1391 PREET 00-0-202-8105	1149	M	28-Feb-06	905	1222	JUNAGADH VADODARA	28-Feb-06 06-Mar-10	Birth Transfer	White-coat colour
1407 DHARTI 000-6CC-240-B	1167	F	21-May-06	734	1113	VADODARA	21-May-06	Birth	White-coat colour
1408 PRUTHVI 000-6CC-2515	1165	F	21-May-06	734	1113	VADODARA	21-May-06	Birth	White-coat colour
Total: 1.2 (3)									
Van Vihar National Park Zoo, Bhopal									
1096 PRIYA 0007150B59	1580	F	10-Nov-98	UNK	UNK	INDIA VANVIHAR	10-Nov-98 18-May-06	Birth Transfer	Normal- coat colour
1356 GAURI 7154446	1581	F	28-Aug-04	UNK	UNK	JAIPUR VANVIHAR	28-Aug-04 21-Mar-13	Birth Transfer	Normal- coat colour
1456 KAMLESH 10033 10016		F	05-Aug-08	UNK	UNK	INDORE VANVIHAR	05-Aug-08 09-Mar-17	Birth Transfer	Normal- coat colour
1488 RIDDHI 10032		F	07-Mar-09	UNK	UNK	INDORE VANVIHAR	07-Mar-09 28-Dec-13	Birth Transfer	Normal- coat colour
1595 BANDHU 0007156C86 10018		M	01-Jan-13	WILD	WILD	BANDHAVG VANVIHAR	01-Jan-13 27-Jun-16	Birth Transfer	Normal- coat colour
1634 PANNA 000715UAAF 10020		M	01-May-10	WILD	WILD	INDIA VANVIHAR	???? 28-Mar-14	Capture Transfer	Normal- coat colour
1655 GANGA 10036 10017		F	09-Jan-15	1700	UNK	INDORE VANVIHAR	09-Jan-15 09-Mar-17	Birth Transfer	Normal- coat colour
1691 MATAKKALI 000715064B 10015		F	01-Aug-16	UNK	UNK	INDIA VANVIHAR	01-Aug-16 21-Nov-16	Birth Transfer	Normal- coat colour
Total: 2.6 (8)									
Vishakapatnam									
894 RANI 0006B75070	1080	F	19-Mar-95	250	247	VISAKAPAT	19-Mar-95	Birth	888 Normal- coat colour
911 SURYA/Rudra	937	M	09-Jun-95	639	476	NANDANKAN VISAKAPAT	09-Jun-95 22-Sep-00	Birth Transfer	W 772 White-coat colour
1174 RANA	1086	M	03-Aug-00	339	894	VISAKAPAT	03-Aug-00	Birth	896 Normal- coat colour
1175 SATHYA	1087	F	03-Aug-00	339	894	VISAKAPAT	03-Aug-00	Birth	897 Normal- coat colour
1213 SHIRISH 0006B72939	1101	M	19-Jun-01	911	950	HYDERABAD VISAKAPAT	19-Jun-01 10-Jul-02	Birth Transfer	910 White-coat colour

National Stud# House Name LocalID Transponder	Int. Std. #	Sex	Birth Date	Sire	Dam	Location	Date	Event	Old NSB # Remarks
1228 JANAKI 0006B75E36	1114	F	02-Nov-01	UNK	882	VISAKAPAT	02-Nov-01	Birth	923 Normal- coat colour
1229 RAJANI	1115	F	02-Nov-01	UNK	882	VISAKAPAT	02-Nov-01	Birth	924 Normal- coat colour
1230 SEETHA 0006B76960	1564	F	02-Nov-01	UNK	882	VISAKAPAT	02-Nov-01	Birth	U 412 Normal- coat colour
1293 CHANDU	1135	F	01-Feb-03	707	894	VISAKAPAT	01-Feb-03	Birth	953 Normal- coat colour
1295 RAMBO	1137	M	01-Feb-03	707	894	VISAKAPAT	01-Feb-03	Birth	955 Normal- coat colour
1296 BALU 0006B785A1	1192	M	01-Feb-03	707	894	VISAKAPAT	01-Feb-03	Birth	Normal- coat colour
1357 KUMARI	1631	F	28-Aug-04	510	950	HYDERABAD VISAKAPAT	28-Aug-04 23-Sep-07	Birth Transfer	White-coat colour
1494 GIRI	1673	M	13-Apr-09	1213	1357	VISAKAPAT	13-Apr-09	Birth	White-coat colour
1495 VANI	1674	F	13-Apr-09	1213	1357	VISAKAPAT	13-Apr-09	Birth	White-coat colour
1496 VEENA	1675	F	13-Apr-09	1213	1357	VISAKAPAT	13-Apr-09	Birth	White-coat colour
1522 SAVITRI		F	16-Mar-11	UNK	1357	VISAKAPAT	16-Mar-11	Birth	White-coat colour
Total: 6.10 (16)									
Total Living: 218.215.3 (436)									

Location Glossary

Mnemonic	Zoo Name
CALCUTTA	Alipore Zoological Garden
MADRAS	Arignar Anna Zoological Park
ASSAM	Assam State Zoo Cum Botanical Garden
AURANGABA	Aurangabad Municipal Zoo
BANNERGHA	Bannerghatta Biological Park
BELLARY	Bellary Zoo
RANCHI	Bhagwan Birsa Biological Park
ITANAGAR	Biological Park, Itanagar
MANGALORE	Dr. K.Shivarma Karanth Piliikula Biological Park
SURAT	Dr. Shyamaprasad Mukharjee Zoological Garden
GADAG	Gadag Zoo
GWALIOR	Gandhi Zoological Park
VISAKAPAT	Indira Gandhi Zoological Park
BOKARO	Jawaharlal Nehru Biological Park
INDORE	Kamla Nehru Prani Sanghralhalaya Zoo
AHMEDABAD	Kamla Nehru Zoological Garden
BILASPUR	Kanan Pandari Zoo
KANPUR	Kanpur Zoological Park
KOTA	Kota Zoo
LUDHIANA	Ludhiana Zoo
JODHPUR	Machia Biological Park (Jodhpur Zoo)
REWA	Maharaja Martand Singh Jedeo White Tiger Safari and Zoo
NAGPUR	Maharajbag Zoo
CHATBIR Z	Mahendra Chaudhury Zoological Park
BHILAI	Maitri Baagh Zoo
JAIPUR	Nahargarh Biological Park (Jaipur Zoo)
NANDANKAN	Nandankanan Biological Park
RAIPUR	Nandanvan Jungle Safari (Naya Raipur)
DELHI	National Zoological Park
LUCKNOW	Nawab Wazid Ali Shah Zoological Garden
HYDERABAD	Nehru Zoological Park
DARJEELIN	Padmaja Naidu Himalayan Zoological Park
NAINITAL	Pt. Govind Ballabh Pant High Altitude Zoo
PUNE	Rajiv Gandhi Zoological Park And Wildlife Research Center
RAJKOT	Rajkot Municipal Zoo
UDAIPUR	Sajjagarh Biological Park (Udaipur Zoo)
JUNAGADH	Sakkarbaug Zoo
PATNA	Sanjay Gandhi Biological Park
BORIVILLI	Sanjay Gandhi National Park And Zoo
VADODARA	Sayaji Baug Zoo
SEPAHIJALA	Sepahijala Zoological Park
KHAIRBARI	South Khairbari Rescue Centre
MYSORE	Sri Chamarajendra Zoological Gardens
TIRUPATI	Sri Venkateswara Zoological Park
THRISUR	State Museum & Zoo
TATA	Tata Steel Zoological Park
TRIVANDRU	Thiruvananthapuram Zoo
SHIMOGA	Tiger & Lion Safari
VANVIHAR	Van Vihar National Park Zoo
VEERMATA	Veermata Jijabai Bhosle Udyan & Zoo

Pedigree Chart Report Bengal Tiger (*Panthera tigris tigris*)

=====
 Taxon Name: PANTHERA TIGRIS Studbook Number: 1
 =====

WILD

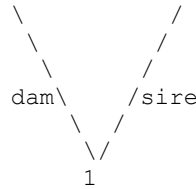

WILD

Sex: Male
 Birth Date: ~ 1950
 Last Location: REWA (dead)
 House Name: MOHAN
 Tattoo:
 Tag/Band:

=====
 Taxon Name: PANTHERA TIGRIS Studbook Number: 2
 =====

WILD

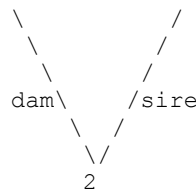

WILD

Sex: Female
 Birth Date: ~ 1951
 Last Location: AHMEDABAD (dead)
 House Name: BEGUM
 Tattoo:
 Tag/Band:

=====
 Taxon Name: PANTHERA TIGRIS Studbook Number: 3
 =====

WILD

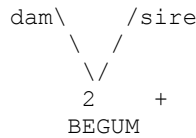

WILD

WILD

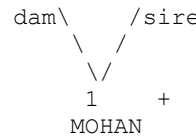

WILD

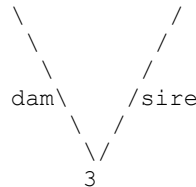

Sex: Female
 Birth Date: 10 Apr 1955
 Last Location: DELHI (dead)
 House Name: RADHA
 Tattoo:
 Tag/Band:

+ Wild-caught...

=====
 Taxon Name: PANTHERA TIGRIS Studbook Number: 4
 =====

WILD

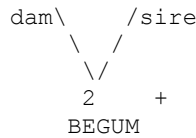

WILD

WILD

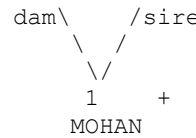

WILD

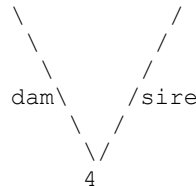

Sex: Male
 Birth Date: 10 Apr 1955
 Last Location: AHMEDABAD (dead)
 House Name:
 Tattoo:
 Tag/Band:

+ Wild-caught...

=====

Taxon Name: PANTHERA TIGRIS Studbook Number: 5

=====

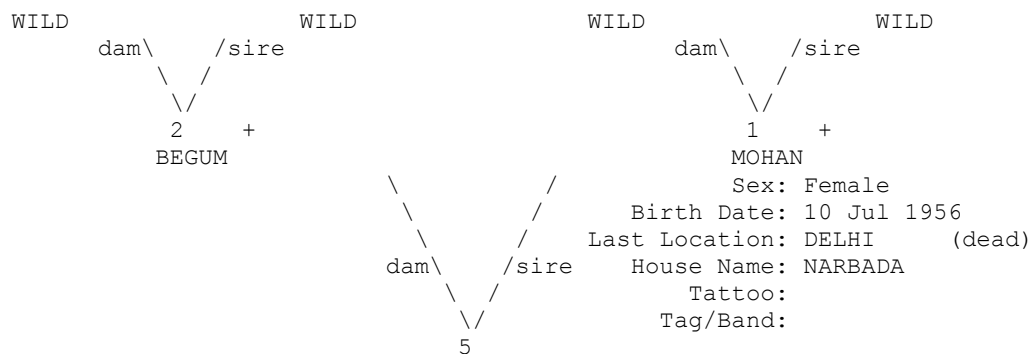

+ Wild-caught...

=====

Taxon Name: PANTHERA TIGRIS Studbook Number: 6

=====



+ Wild-caught...

=====

Taxon Name: PANTHERA TIGRIS Studbook Number: 7

=====

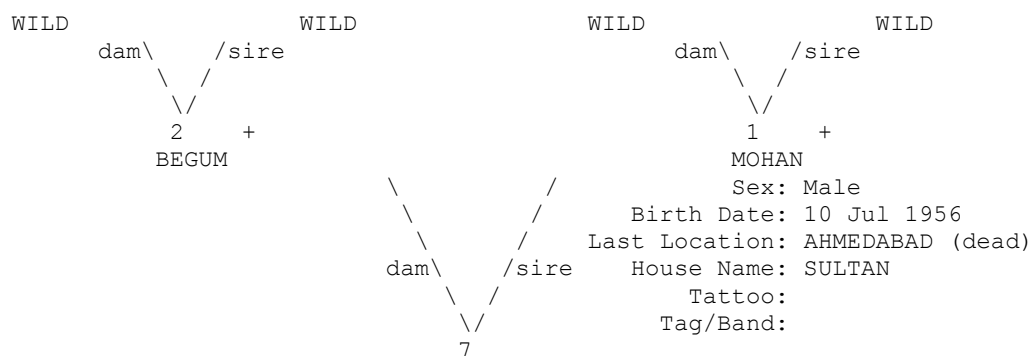

+ Wild-caught...

=====
 Taxon Name: PANTHERA TIGRIS Studbook Number: 8
 =====

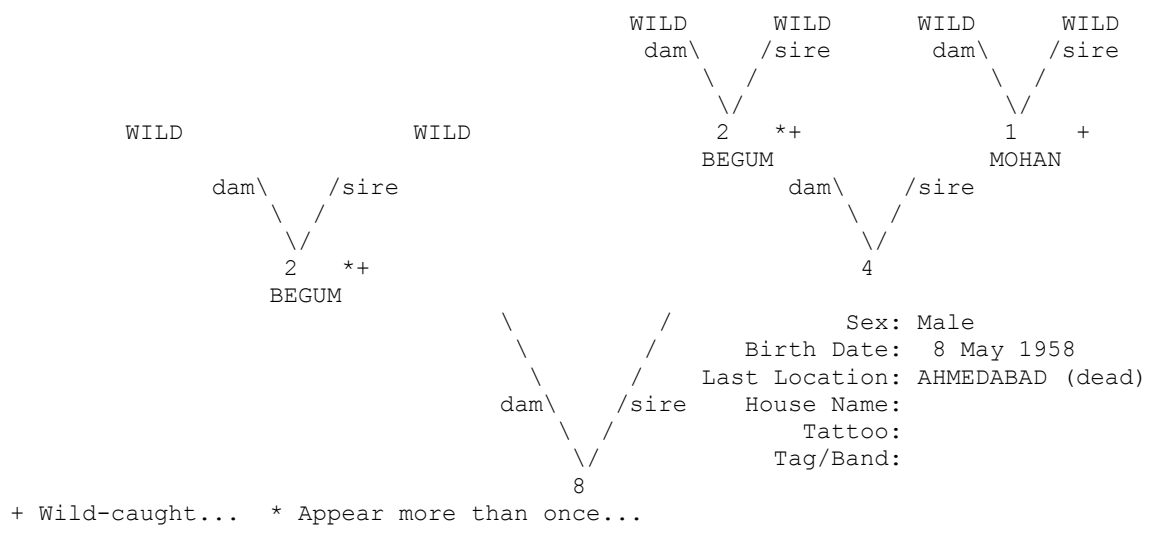

=====
 Taxon Name: PANTHERA TIGRIS Studbook Number: 9
 =====

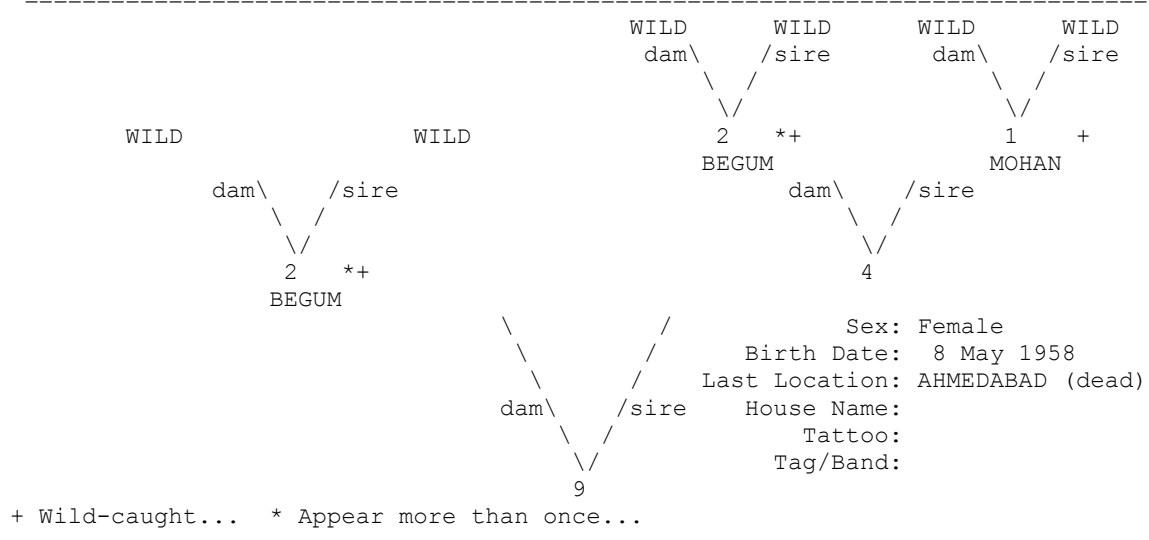

=====
 Taxon Name: PANTHERA TIGRIS Studbook Number: 10
 =====

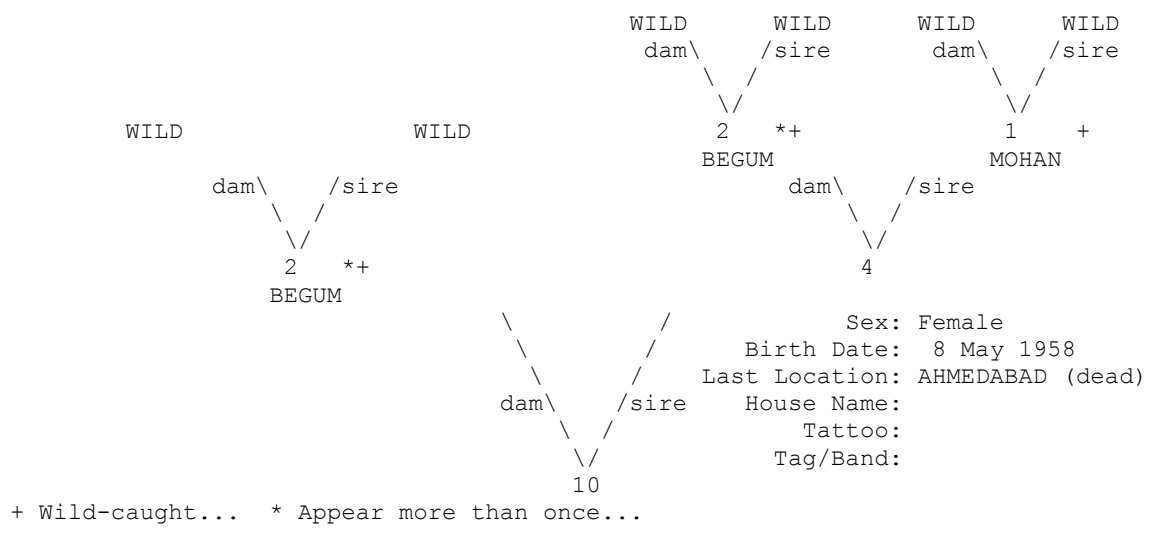

=====
Taxon Name: PANTHERA TIGRIS Studbook Number: 11
=====

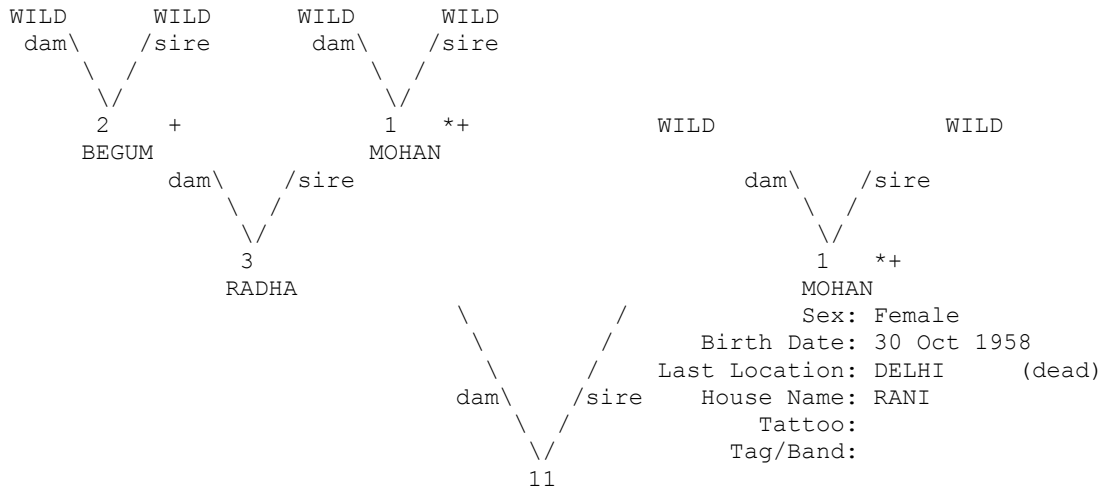

+ Wild-caught... * Appear more than once...

=====
Taxon Name: PANTHERA TIGRIS Studbook Number: 12
=====

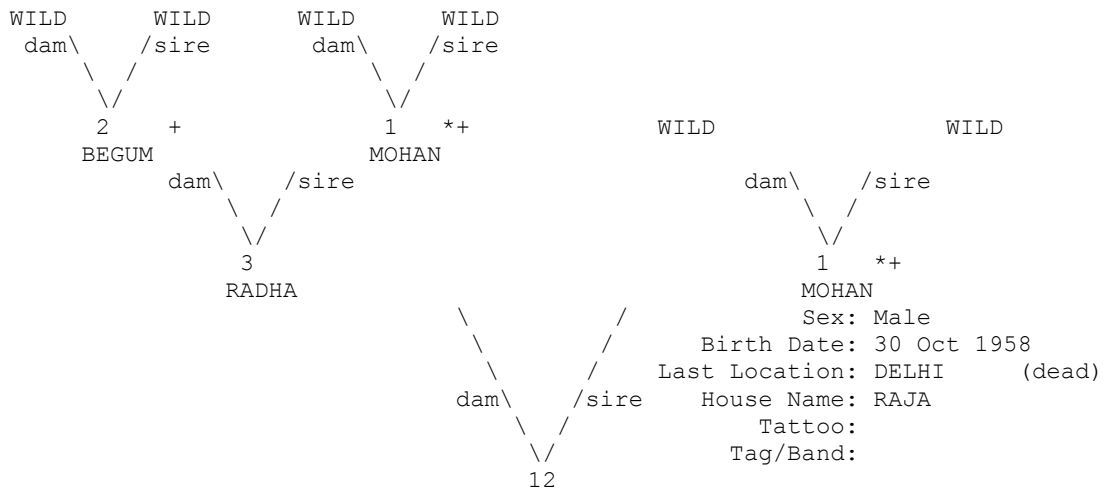

+ Wild-caught... * Appear more than once...

=====
Taxon Name: PANTHERA TIGRIS Studbook Number: 13
=====

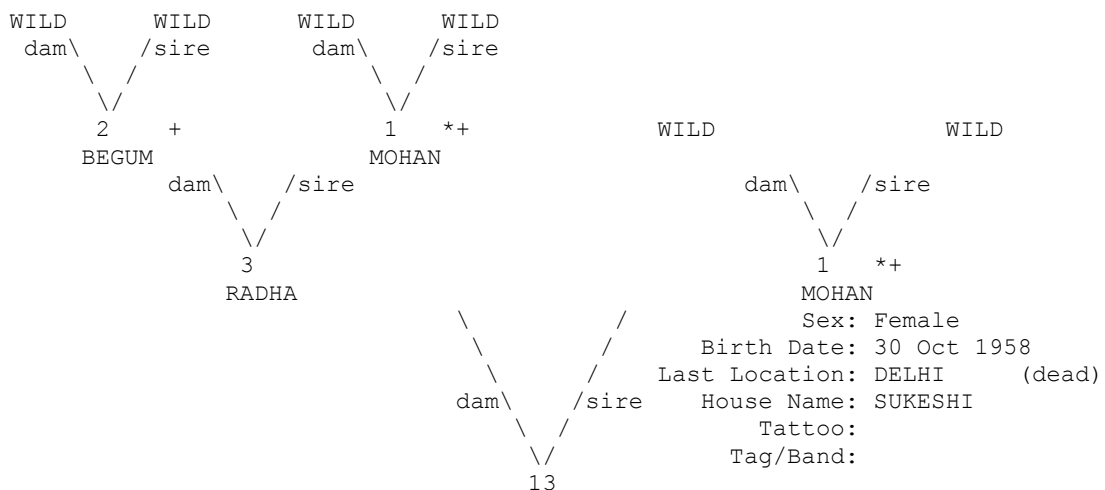

+ Wild-caught... * Appear more than once...

```

=====
Taxon Name: PANTHERA TIGRIS                               Studbook Number: 17
=====
WILD                                                       WILD
                                                           Sex: Male
                                                           Birth Date: ~ 1946
                                                           Last Location: ASSAM (dead)
                                                           House Name: BHOLA
                                                           Tattoo:
                                                           Tag/Band:
    \
    \ dam \
    \ \
    \ \ 17
    / \
    / /sire
    /

```

```

=====
Taxon Name: PANTHERA TIGRIS                               Studbook Number: 18
=====
WILD                                                       WILD
                                                           Sex: Male
                                                           Birth Date: 28 Sep 1959
                                                           Last Location: AHMEDABAD
                                                           House Name:
                                                           Tattoo:
                                                           Tag/Band:
    \
    \ dam \
    \ \
    \ \ 2  *+
    \ \ BEGUM
    / \
    / /sire
    /
WILD                                                       WILD
                                                           Sex: Male
                                                           Birth Date: 28 Sep 1959
                                                           Last Location: AHMEDABAD
                                                           House Name:
                                                           Tattoo:
                                                           Tag/Band:
    \
    \ dam \
    \ \
    \ \ 1  +
    \ \ MOHAN
    / \
    / /sire
    /
WILD                                                       WILD
                                                           Sex: Male
                                                           Birth Date: 28 Sep 1959
                                                           Last Location: AHMEDABAD
                                                           House Name:
                                                           Tattoo:
                                                           Tag/Band:
    \
    \ dam \
    \ \
    \ \ 7
    \ \ SULTAN
    / \
    / /sire
    /
WILD                                                       WILD
                                                           Sex: Male
                                                           Birth Date: 28 Sep 1959
                                                           Last Location: AHMEDABAD
                                                           House Name:
                                                           Tattoo:
                                                           Tag/Band:
    \
    \ dam \
    \ \
    \ \ 2  *+
    \ \ BEGUM
    / \
    / /sire
    /
    \
    \ dam \
    \ \
    \ \ 18
    / \
    / /sire
    /

```

+ Wild-caught... * Appear more than once...

```

=====
Taxon Name: PANTHERA TIGRIS                               Studbook Number: 19
=====
WILD                                                       WILD
                                                           Sex: Female
                                                           Birth Date: 28 Sep 1959
                                                           Last Location: AHMEDABAD
                                                           House Name:
                                                           Tattoo:
                                                           Tag/Band:
    \
    \ dam \
    \ \
    \ \ 2  *+
    \ \ BEGUM
    / \
    / /sire
    /
WILD                                                       WILD
                                                           Sex: Female
                                                           Birth Date: 28 Sep 1959
                                                           Last Location: AHMEDABAD
                                                           House Name:
                                                           Tattoo:
                                                           Tag/Band:
    \
    \ dam \
    \ \
    \ \ 1  +
    \ \ MOHAN
    / \
    / /sire
    /
WILD                                                       WILD
                                                           Sex: Female
                                                           Birth Date: 28 Sep 1959
                                                           Last Location: AHMEDABAD
                                                           House Name:
                                                           Tattoo:
                                                           Tag/Band:
    \
    \ dam \
    \ \
    \ \ 7
    \ \ SULTAN
    / \
    / /sire
    /
WILD                                                       WILD
                                                           Sex: Female
                                                           Birth Date: 28 Sep 1959
                                                           Last Location: AHMEDABAD
                                                           House Name:
                                                           Tattoo:
                                                           Tag/Band:
    \
    \ dam \
    \ \
    \ \ 2  *+
    \ \ BEGUM
    / \
    / /sire
    /
    \
    \ dam \
    \ \
    \ \ 19
    / \
    / /sire
    /

```

+ Wild-caught... * Appear more than once...

=====
 Taxon Name: PANTHERA TIGRIS Studbook Number: 20
 =====

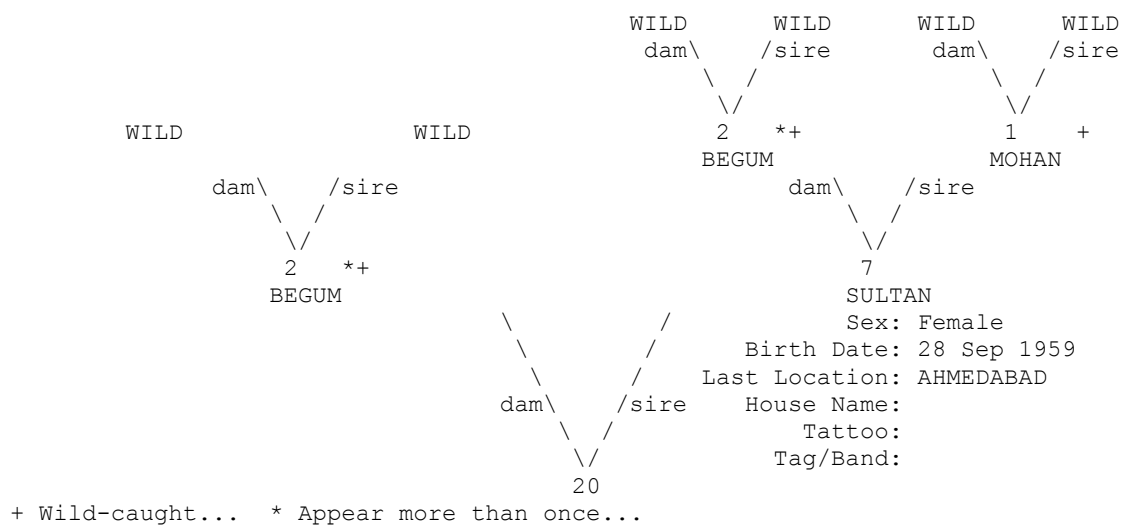

=====
 Taxon Name: PANTHERA TIGRIS Studbook Number: 21
 =====

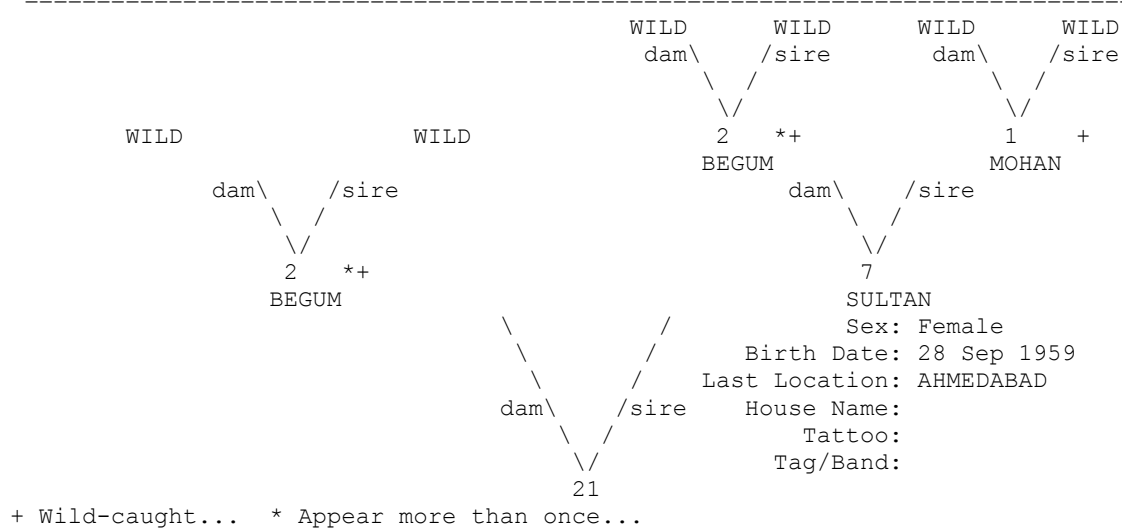

=====
 Taxon Name: PANTHERA TIGRIS Studbook Number: 22
 =====

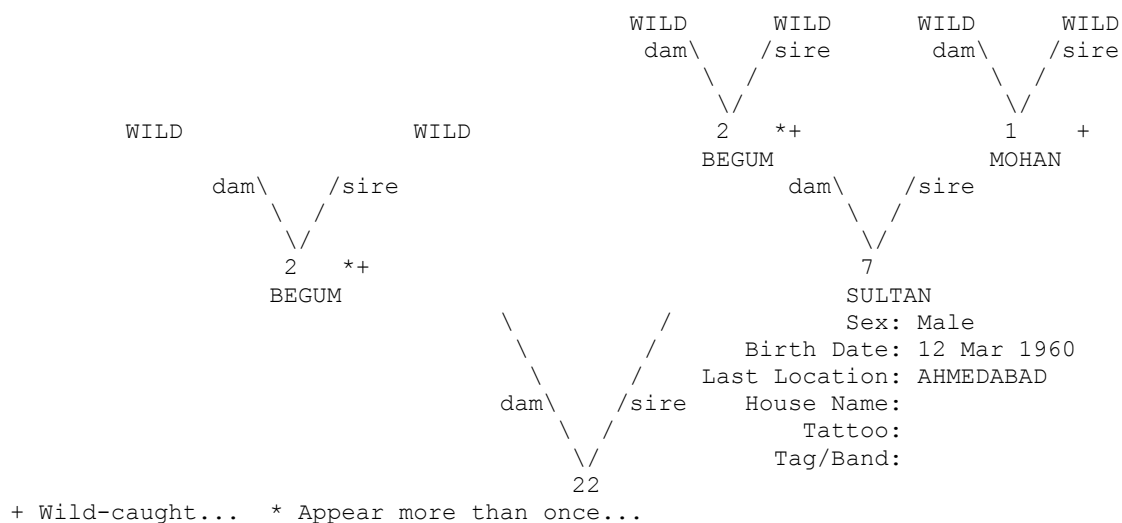

```

=====
Taxon Name: PANTHERA TIGRIS                               Studbook Number: 26
=====
WILD                                                       WILD
                                                           Sex: Female
                                                           Birth Date: ~ 1957
                                                           Last Location: NANDANKAN (dead)
                                                           House Name: SIKHA
                                                           Tattoo:
                                                           Tag/Band:
    dam\  \  /
      \  /  \
       26
  
```

```

=====
Taxon Name: PANTHERA TIGRIS                               Studbook Number: 27
=====
WILD dam\  \  / WILD dam\  \  / WILD dam\  \  / WILD dam\  \  /
 2 + 1 *+
BEGUM MOHAN
    dam\  \  /
      \  /  \
       3
  RADHA
    dam\  \  /
      \  /  \
       27
  
```

WILD WILD
 dam\ \ / dam\ \ /
 1 *+
 MOHAN
 Sex: Male
 Birth Date: 18 Jun 1960
 Last Location: CALCUTTA (dead)
 House Name: HIMADARI
 Tattoo:
 Tag/Band:

+ Wild-caught... * Appear more than once...

```

=====
Taxon Name: PANTHERA TIGRIS                               Studbook Number: 28
=====
WILD dam\  \  / WILD dam\  \  / WILD dam\  \  / WILD dam\  \  /
 2 + 1 *+
BEGUM MOHAN
    dam\  \  /
      \  /  \
       3
  RADHA
    dam\  \  /
      \  /  \
       28
  
```

WILD WILD
 dam\ \ / dam\ \ /
 1 *+
 MOHAN
 Sex: Male
 Birth Date: 18 Jun 1960
 Last Location: CALCUTTA (dead)
 House Name: NEELADARI
 Tattoo:
 Tag/Band:

+ Wild-caught... * Appear more than once...

=====
 Taxon Name: PANTHERA TIGRIS Studbook Number: 29
 =====

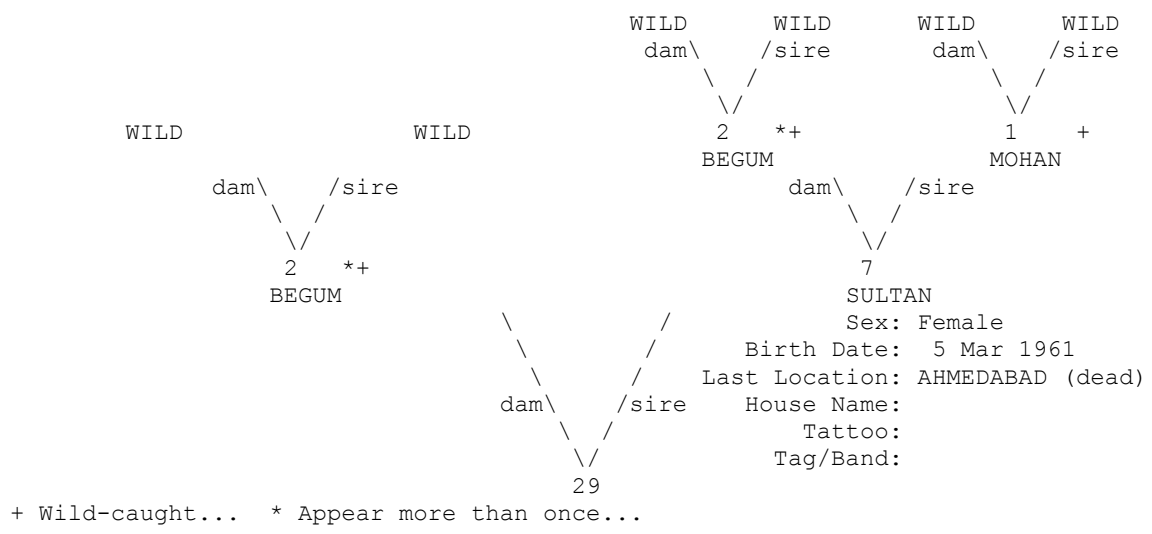

=====
 Taxon Name: PANTHERA TIGRIS Studbook Number: 30
 =====

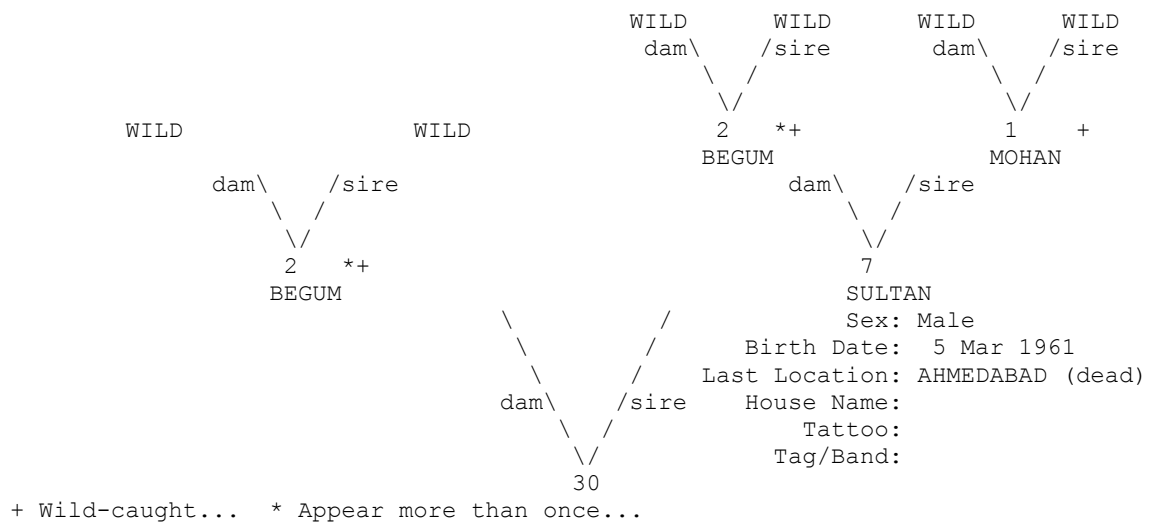

=====
 Taxon Name: PANTHERA TIGRIS Studbook Number: 31
 =====

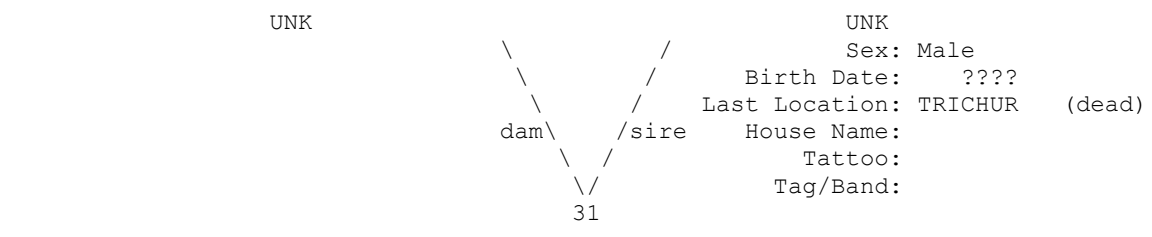

=====
 Taxon Name: PANTHERA TIGRIS Studbook Number: 32
 =====

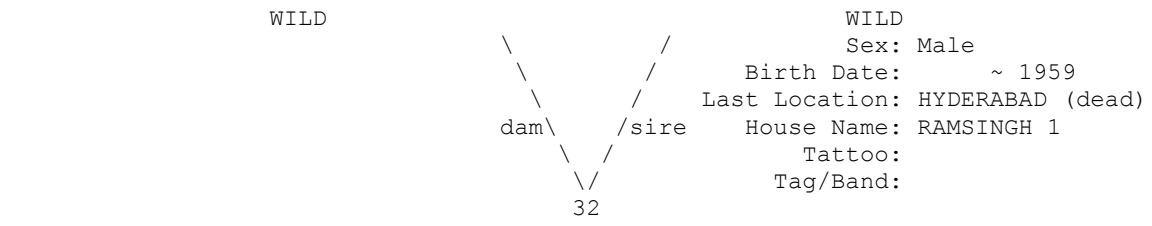

=====
 Taxon Name: PANTHERA TIGRIS Studbook Number: 36
 =====

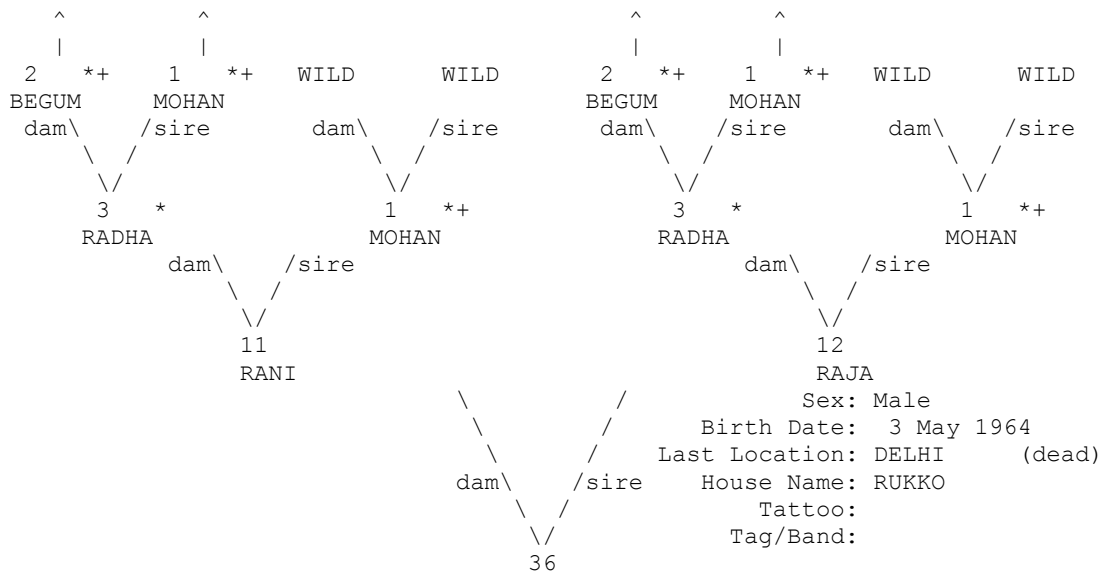

+ Wild-caught... * Appear more than once...
 ^ Pedigree continues beyond top of page...

=====
 Taxon Name: PANTHERA TIGRIS Studbook Number: 37
 =====

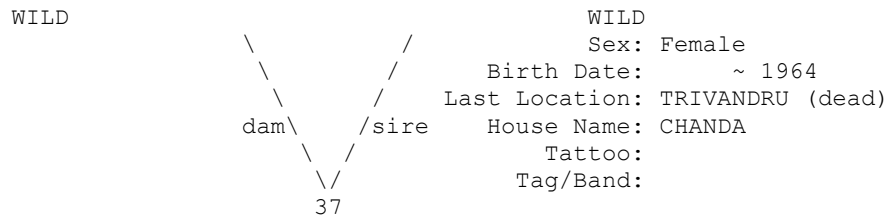

=====
 Taxon Name: PANTHERA TIGRIS Studbook Number: 38
 =====

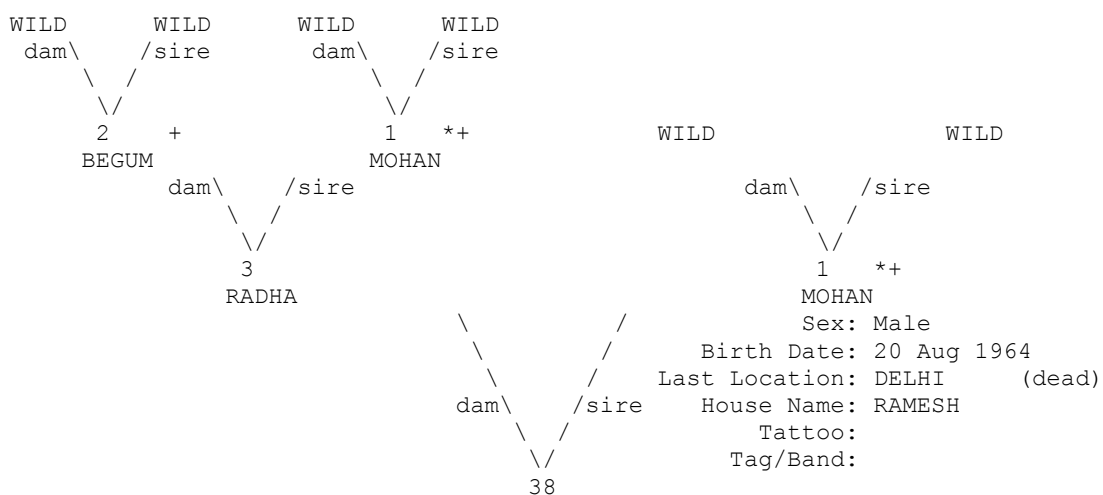

+ Wild-caught... * Appear more than once...

=====
Taxon Name: PANTHERA TIGRIS Studbook Number: 39
=====

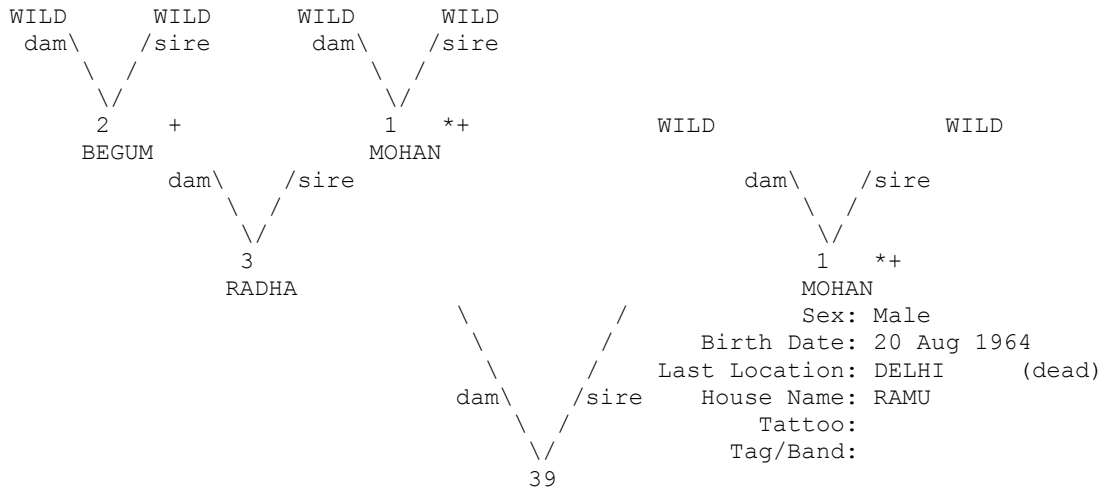

+ Wild-caught... * Appear more than once...

=====
Taxon Name: PANTHERA TIGRIS Studbook Number: 40
=====

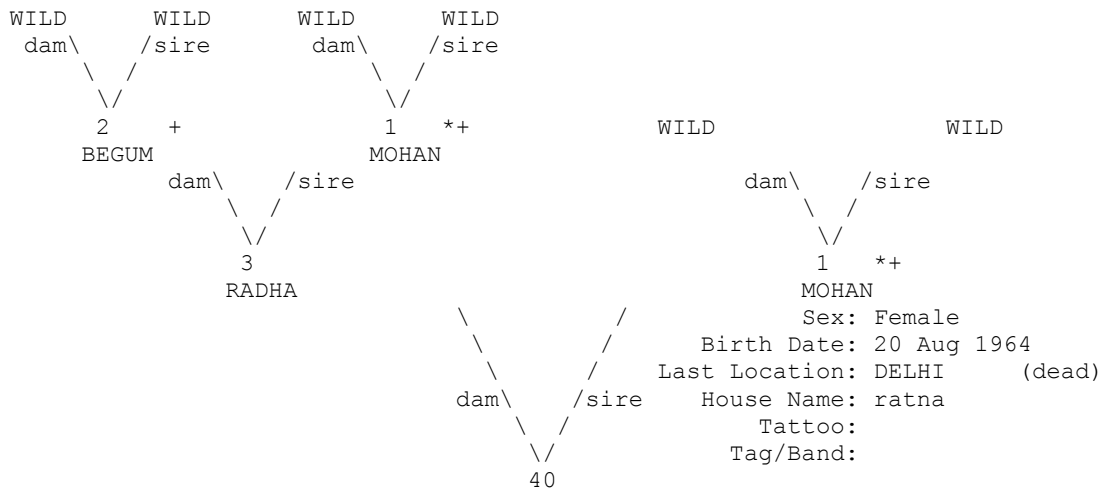

+ Wild-caught... * Appear more than once...

=====
Taxon Name: PANTHERA TIGRIS Studbook Number: 43
=====

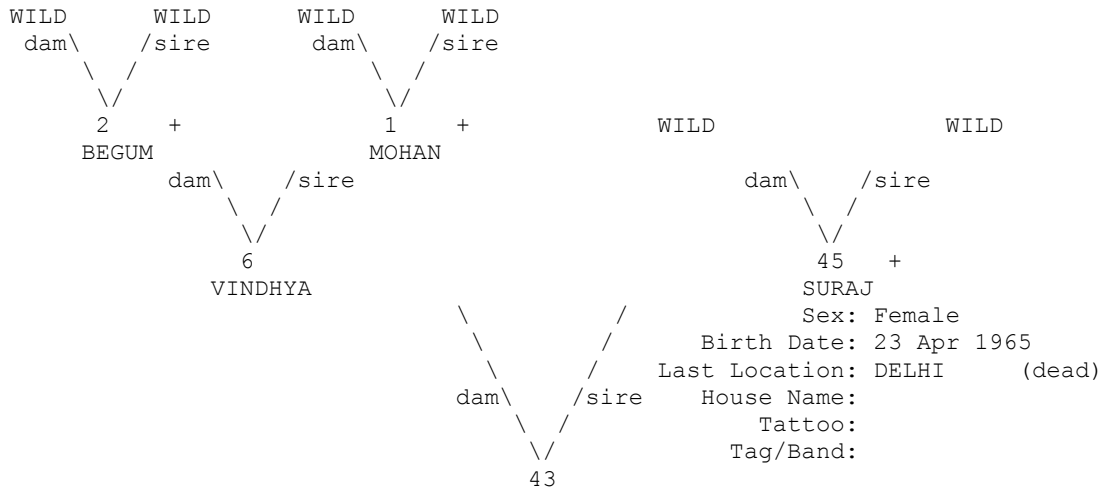

+ Wild-caught...

=====
Taxon Name: PANTHERA TIGRIS Studbook Number: 44
=====

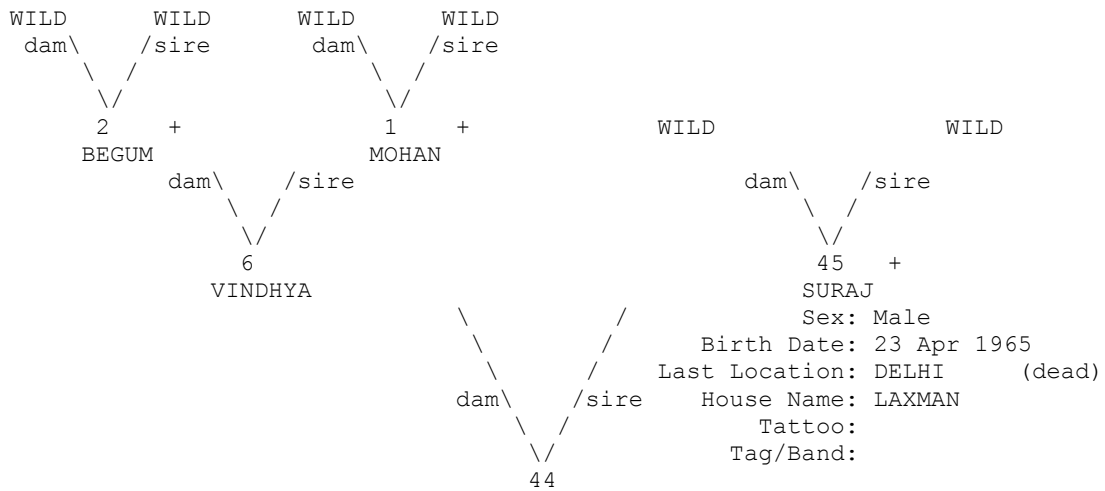

+ Wild-caught...

=====
Taxon Name: PANTHERA TIGRIS Studbook Number: 45
=====

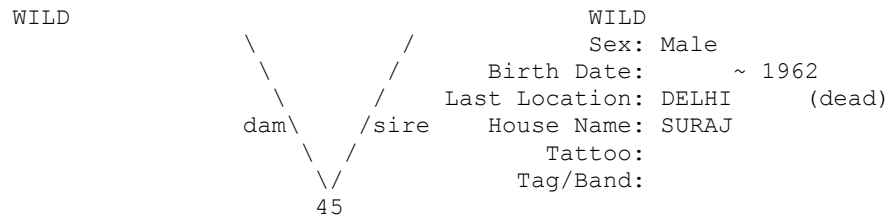

=====
 Taxon Name: PANTHERA TIGRIS Studbook Number: 46
 =====

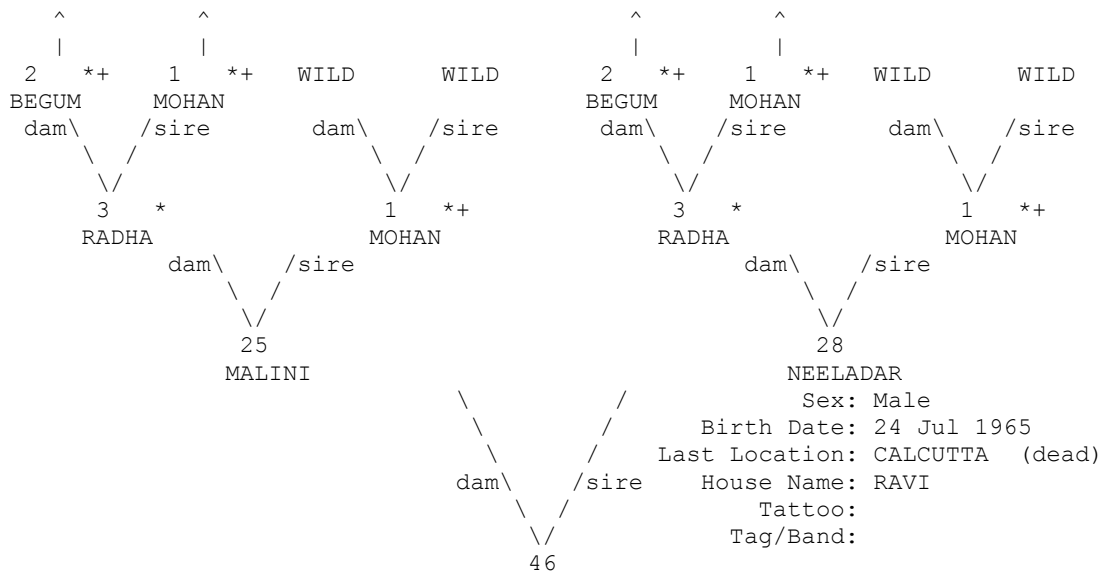

+ Wild-caught... * Appear more than once...
 ^ Pedigree continues beyond top of page...

=====
 Taxon Name: PANTHERA TIGRIS Studbook Number: 47
 =====

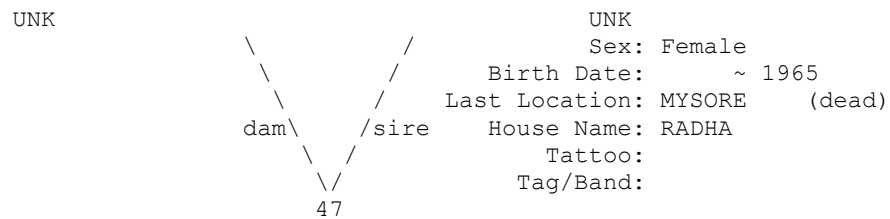

=====
 Taxon Name: PANTHERA TIGRIS Studbook Number: 48
 =====

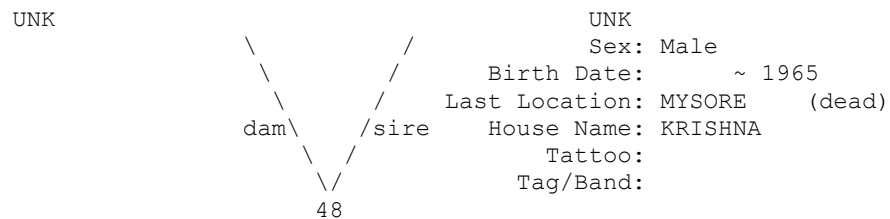

=====
 Taxon Name: PANTHERA TIGRIS Studbook Number: 49
 =====

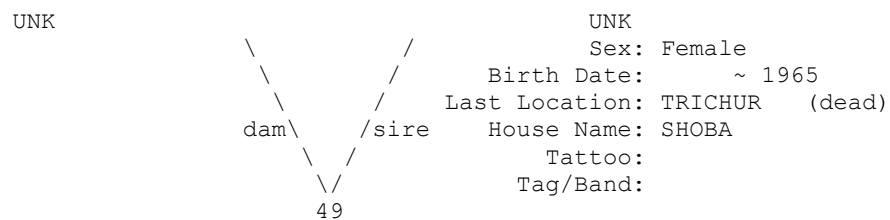

=====
 Taxon Name: PANTHERA TIGRIS Studbook Number: 50
 =====

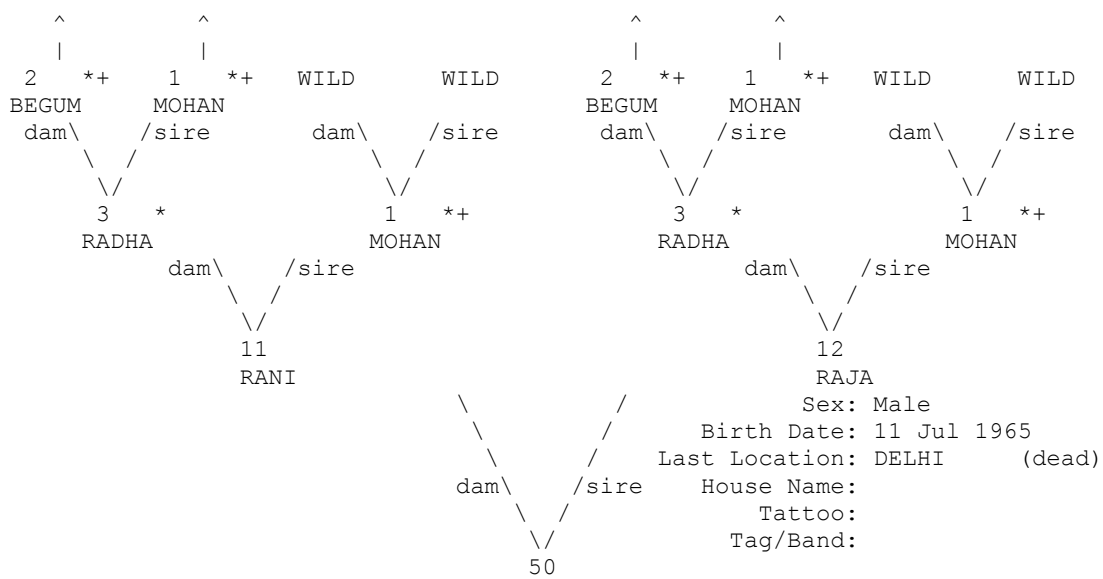

+ Wild-caught... * Appear more than once...
 ^ Pedigree continues beyond top of page...

=====
 Taxon Name: PANTHERA TIGRIS Studbook Number: 51
 =====

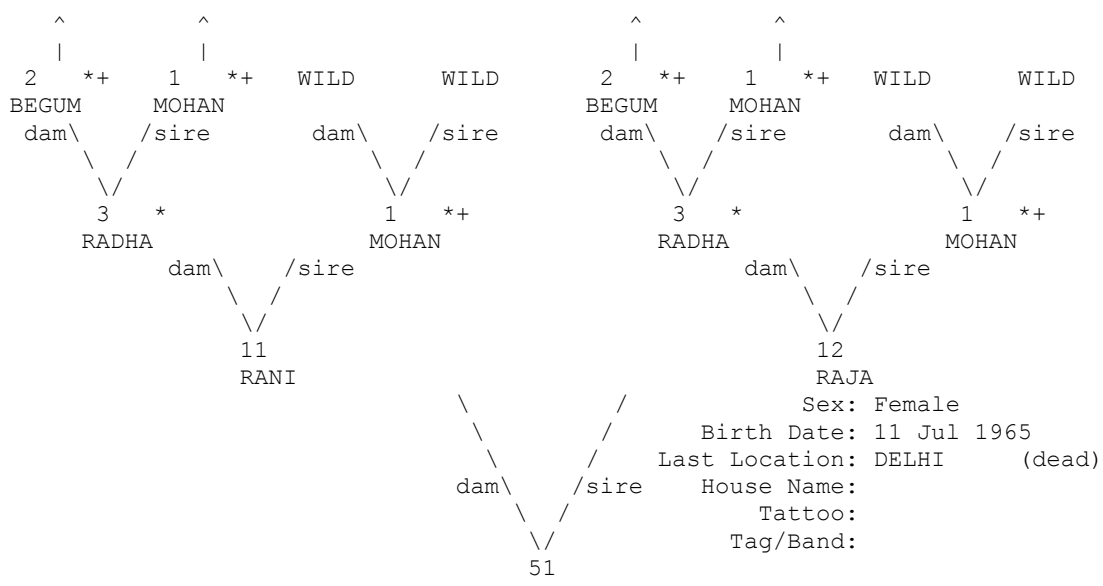

+ Wild-caught... * Appear more than once...
 ^ Pedigree continues beyond top of page...

=====
 Taxon Name: PANTHERA TIGRIS Studbook Number: 52
 =====

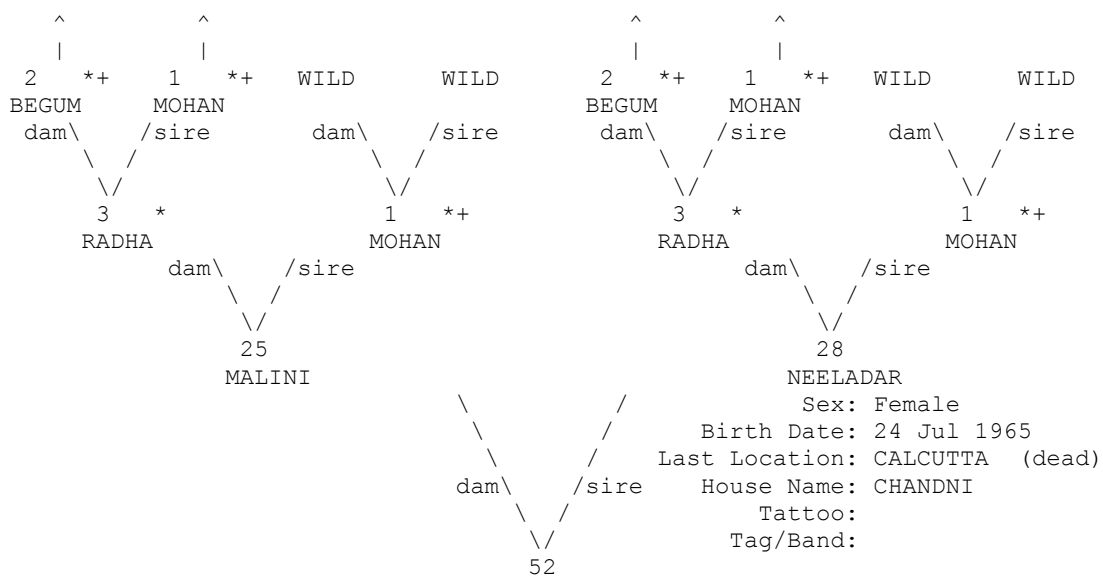

+ Wild-caught... * Appear more than once...
 ^ Pedigree continues beyond top of page...

=====
 Taxon Name: PANTHERA TIGRIS Studbook Number: 53
 =====

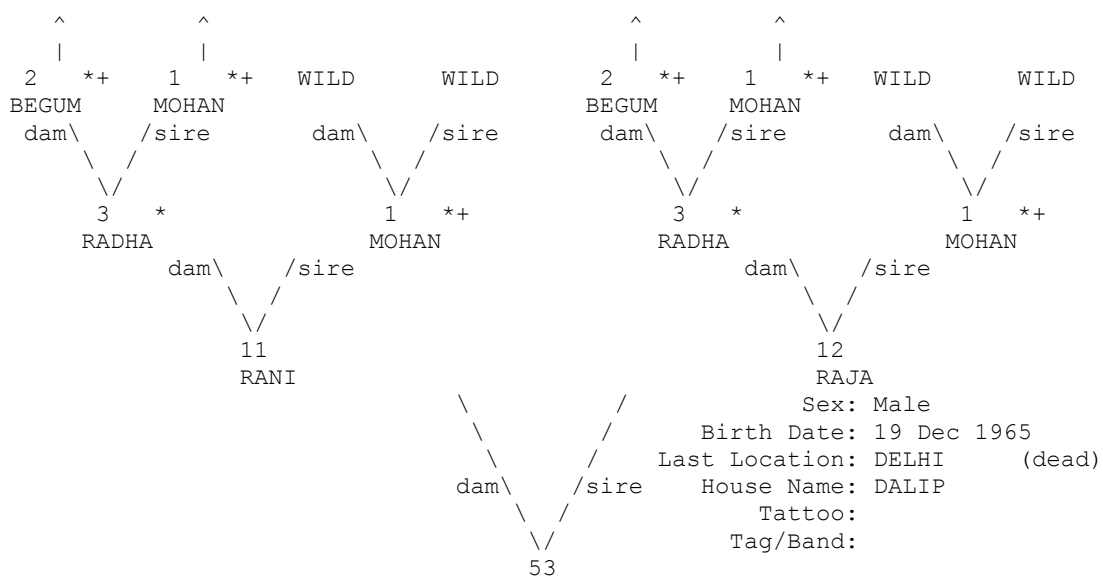

+ Wild-caught... * Appear more than once...
 ^ Pedigree continues beyond top of page...

=====
 Taxon Name: PANTHERA TIGRIS Studbook Number: 54
 =====

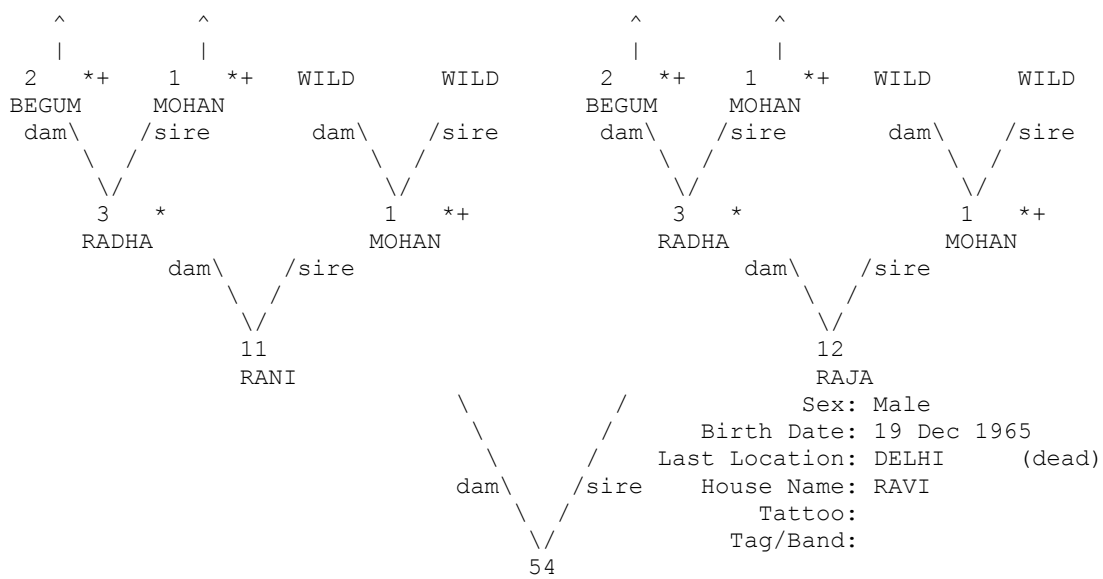

+ Wild-caught... * Appear more than once...
 ^ Pedigree continues beyond top of page...

=====
 Taxon Name: PANTHERA TIGRIS Studbook Number: 55
 =====

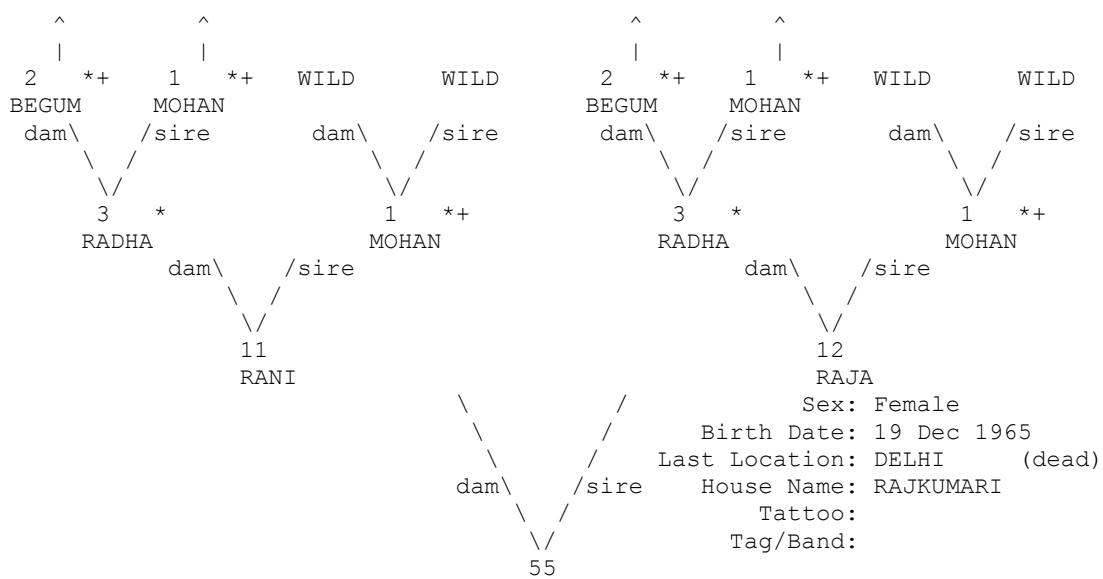

+ Wild-caught... * Appear more than once...
 ^ Pedigree continues beyond top of page...

=====
 Taxon Name: PANTHERA TIGRIS Studbook Number: 56
 =====

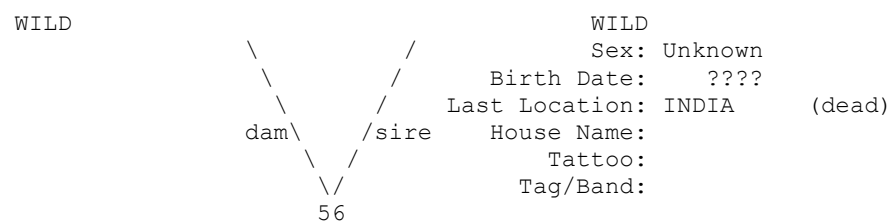

=====
Taxon Name: PANTHERA TIGRIS Studbook Number: 60
=====

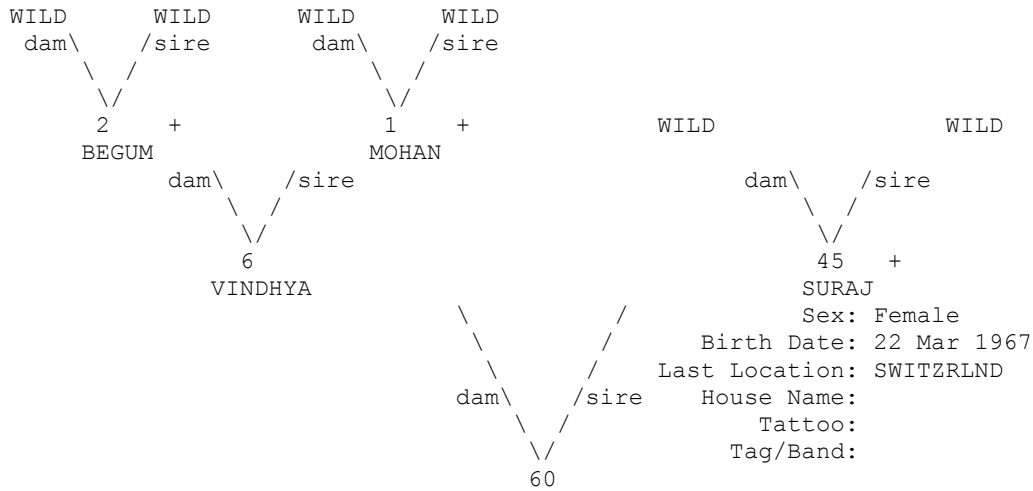

+ Wild-caught...

=====
Taxon Name: PANTHERA TIGRIS Studbook Number: 61
=====

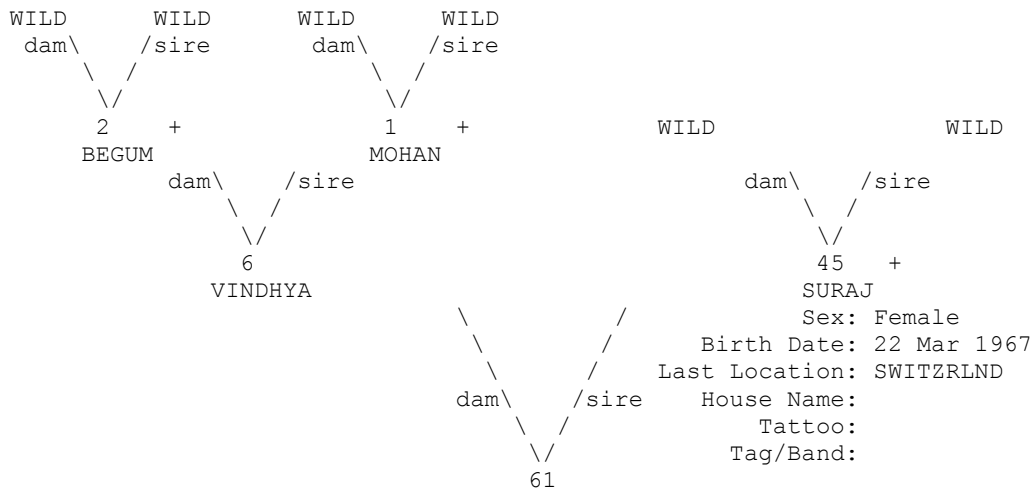

+ Wild-caught...

=====
Taxon Name: PANTHERA TIGRIS Studbook Number: 62
=====

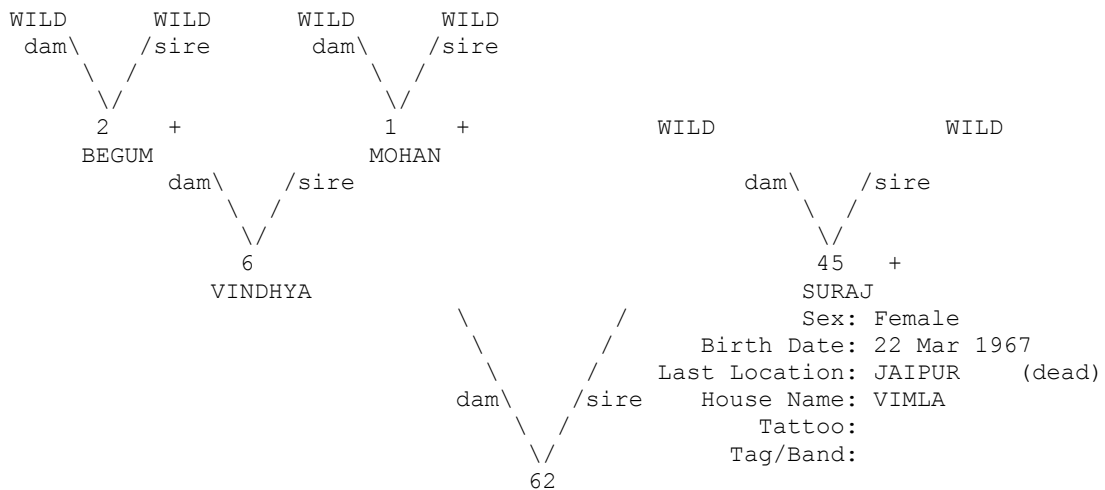

+ Wild-caught...

```

=====
Taxon Name: PANTHERA TIGRIS                               Studbook Number: 63
=====
WILD                                                       WILD
                                                           Sex: Male
                                                           Birth Date:  ???
Last Location: HYDERABAD (dead)
House Name: RAM SINGH JR
Tattoo:
Tag/Band:

      dam \      /
           \    /
            \  /
             \ /
              V
             63

```

```

=====
Taxon Name: PANTHERA TIGRIS                               Studbook Number: 64
=====
WILD                                                       WILD
                                                           Sex: Female
                                                           Birth Date:  ???
Last Location: HYDERABAD (dead)
House Name: MOTI
Tattoo:
Tag/Band:

      dam \      /
           \    /
            \  /
             \ /
              V
             64

```

```

=====
Taxon Name: PANTHERA TIGRIS                               Studbook Number: 65
=====
      ^           ^           ^           ^
      |           |           |           |
      2 *+       1 *+       WILD       WILD       2 *+       1 *+       WILD       WILD
      |           |           |           |       |           |           |           |
      dam \      /       dam \      /       dam \      /       dam \      /
      |           |       |           |       |           |       |           |
      3 *         1 *+       3 *         1 *+       3 *         1 *+
      |           |       |           |       |           |       |           |
      RADHA       MOHAN       RADHA       MOHAN       RADHA       MOHAN
      |           |       |           |       |           |       |           |
      dam \      /       dam \      /       dam \      /       dam \      /
      |           |       |           |       |           |       |           |
      25          MALINI       28          NEELADAR
      |           |       |           |       |           |       |           |
      dam \      /       dam \      /       |           |       |           |
      |           |       |           |       |           |       |           |
      65

```

+ Wild-caught... * Appear more than once...
^ Pedigree continues beyond top of page...

```

=====
Taxon Name: PANTHERA TIGRIS                               Studbook Number: 66
=====
UNK                                                       UNK
                                                           Sex: Female
                                                           Birth Date:  ???
Last Location: AHMEDABAD (dead)
House Name:
Tattoo:
Tag/Band:

      dam \      /
           \    /
            \  /
             \ /
              V
             66

```

=====
Taxon Name: PANTHERA TIGRIS

Studbook Number: 67
=====

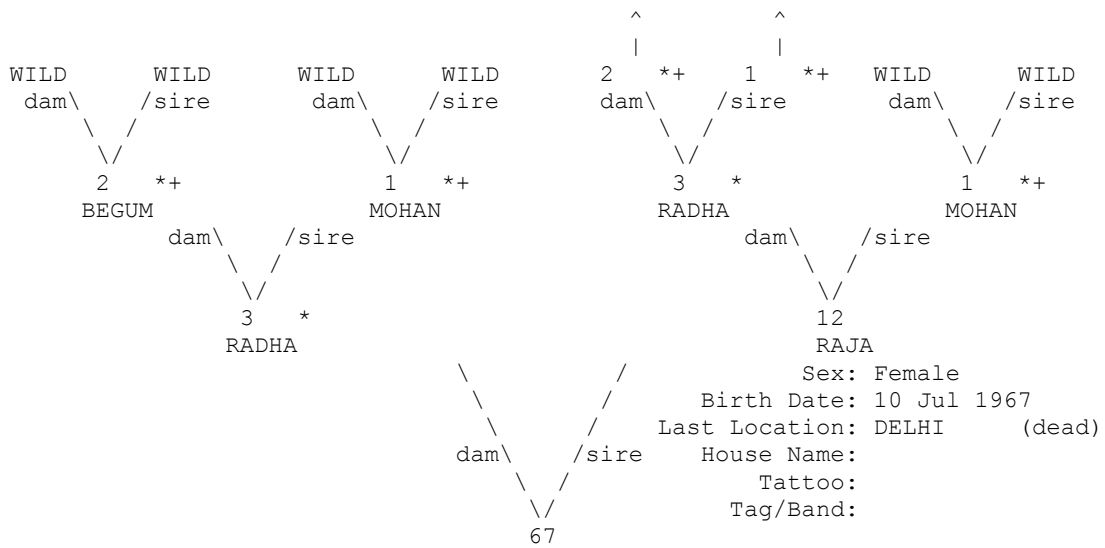

+ Wild-caught... * Appear more than once...
^ Pedigree continues beyond top of page...

=====
Taxon Name: PANTHERA TIGRIS

Studbook Number: 68
=====

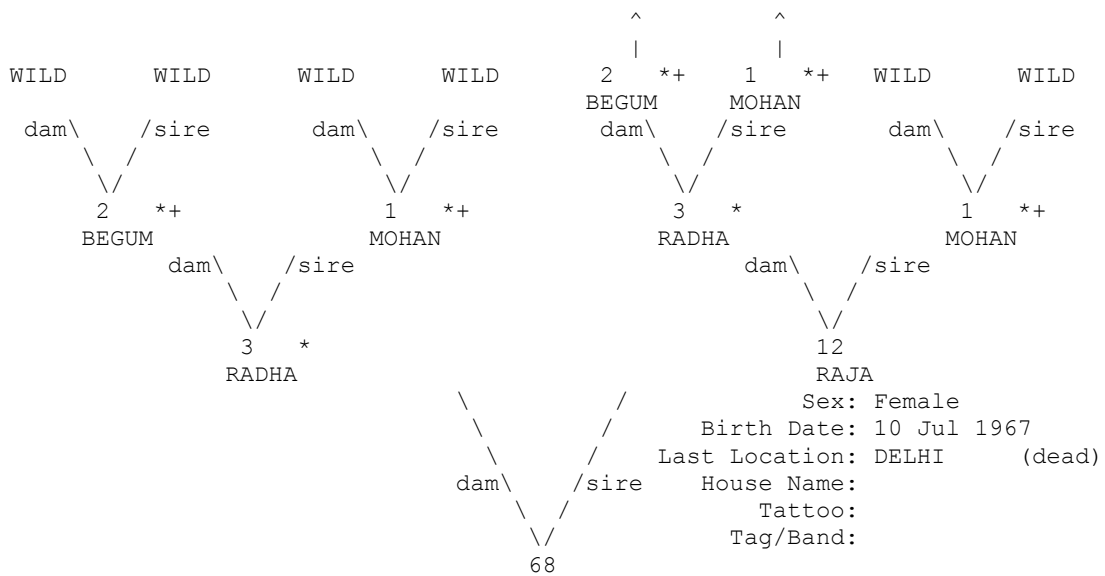

+ Wild-caught... * Appear more than once...
^ Pedigree continues beyond top of page...

=====
 Taxon Name: PANTHERA TIGRIS Studbook Number: 69
 =====

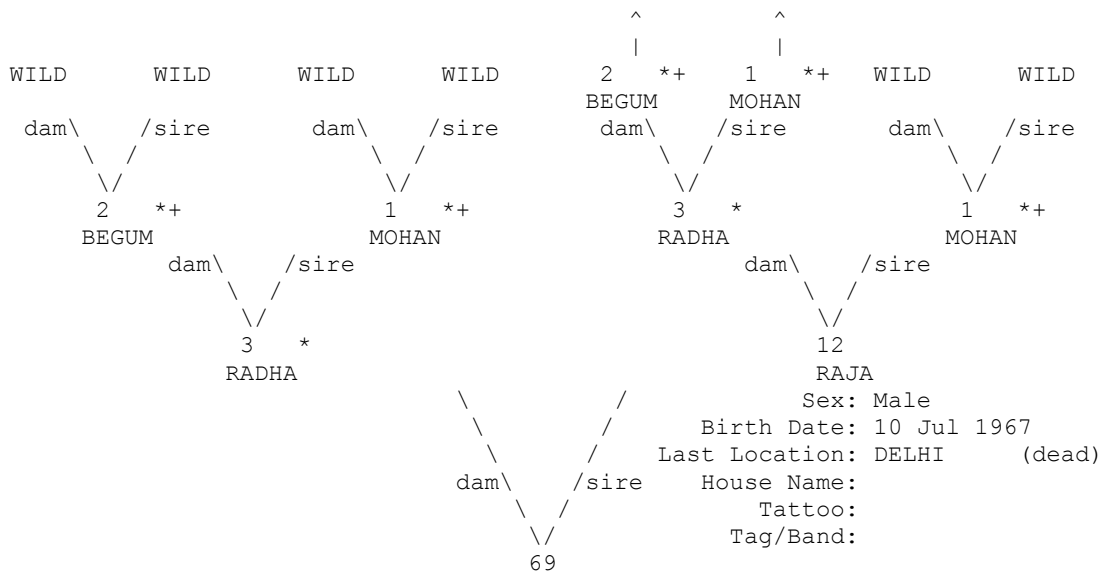

+ Wild-caught... * Appear more than once...
 ^ Pedigree continues beyond top of page...

=====
 Taxon Name: PANTHERA TIGRIS Studbook Number: 70
 =====

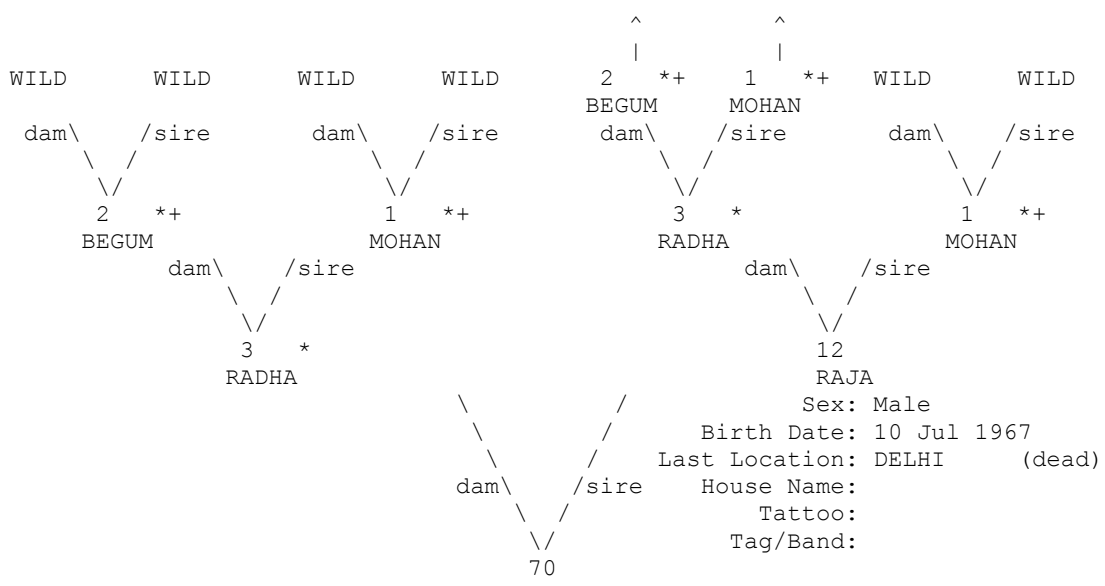

+ Wild-caught... * Appear more than once...
 ^ Pedigree continues beyond top of page...

=====
 Taxon Name: PANTHERA TIGRIS Studbook Number: 71
 =====

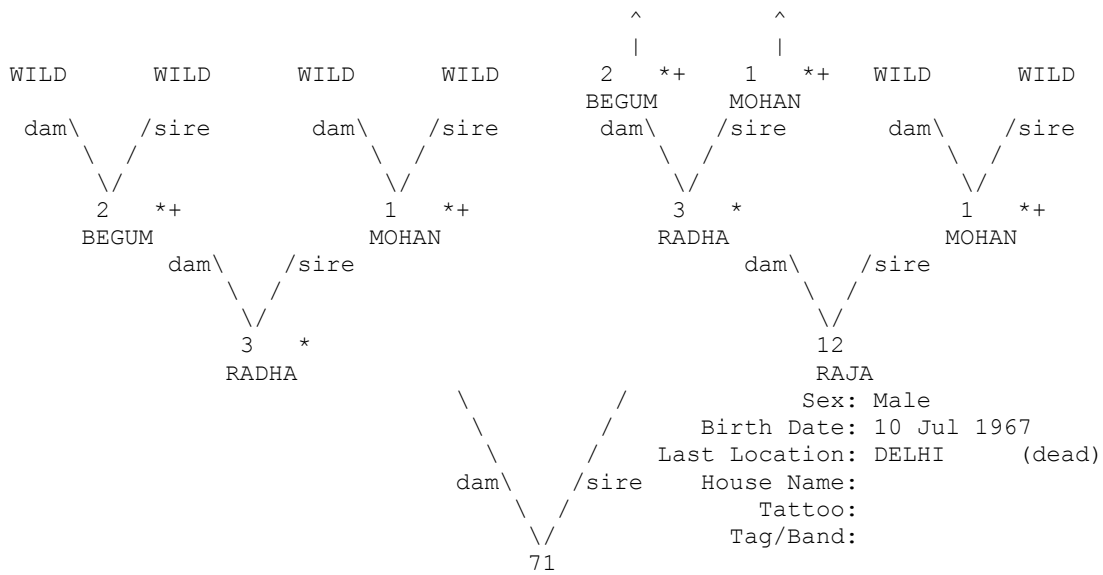

+ Wild-caught... * Appear more than once...
 ^ Pedigree continues beyond top of page...

=====
 Taxon Name: PANTHERA TIGRIS Studbook Number: 72
 =====

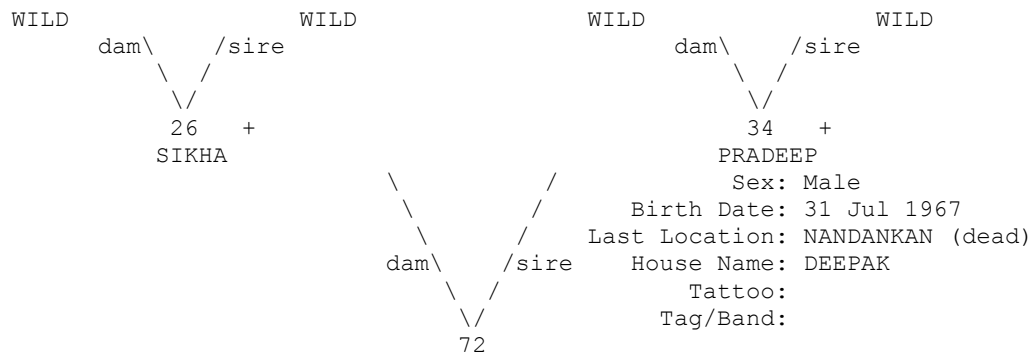

+ Wild-caught...

=====
 Taxon Name: PANTHERA TIGRIS Studbook Number: 73
 =====

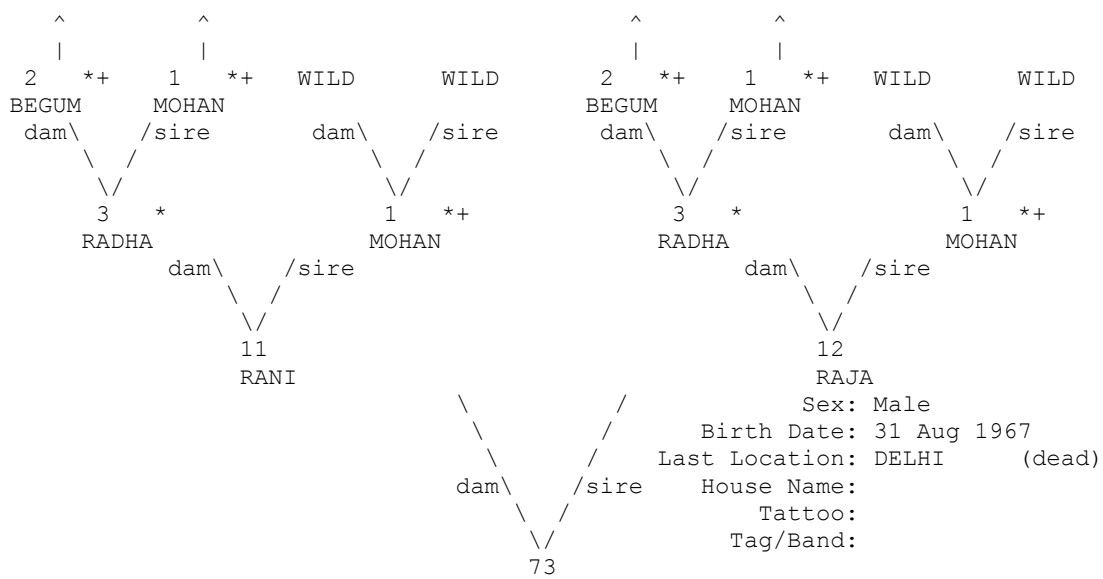

+ Wild-caught... * Appear more than once...
 ^ Pedigree continues beyond top of page...

=====
 Taxon Name: PANTHERA TIGRIS Studbook Number: 74
 =====

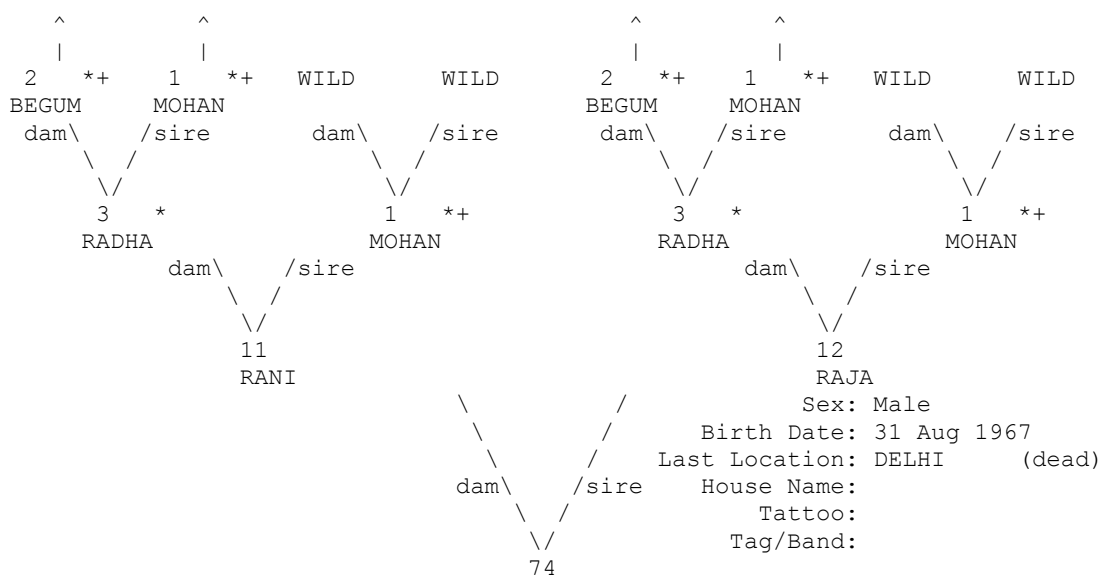

+ Wild-caught... * Appear more than once...
 ^ Pedigree continues beyond top of page...

=====
 Taxon Name: PANTHERA TIGRIS Studbook Number: 75
 =====

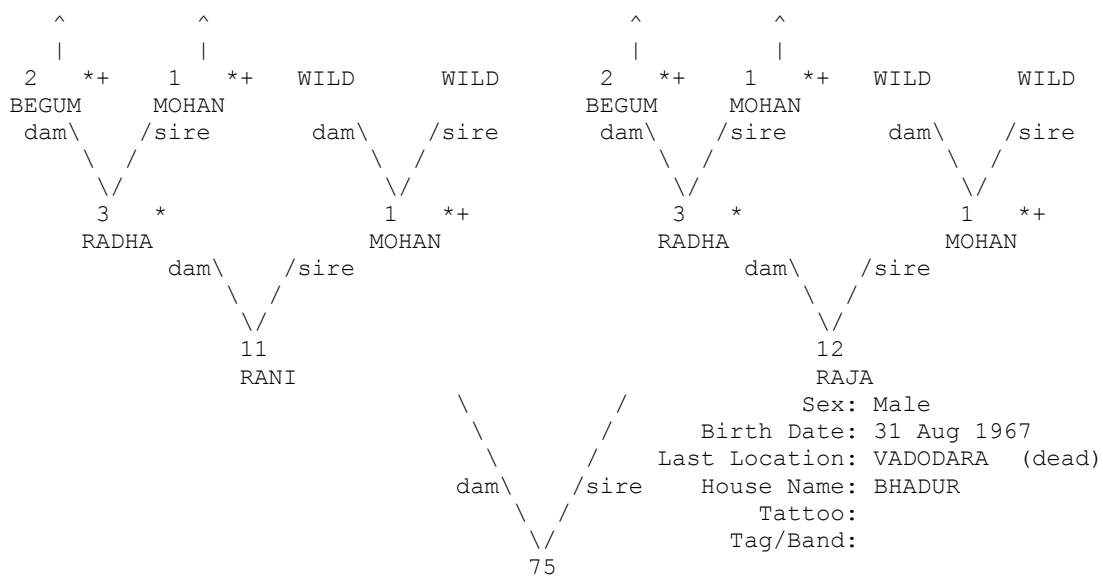

+ Wild-caught... * Appear more than once...
 ^ Pedigree continues beyond top of page...

=====
 Taxon Name: PANTHERA TIGRIS Studbook Number: 76
 =====

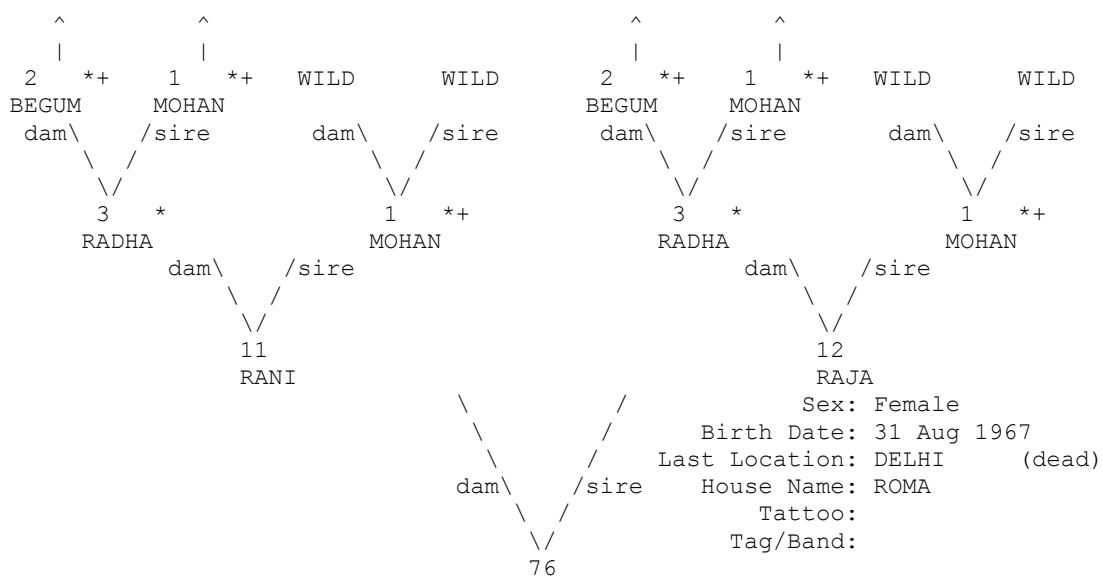

+ Wild-caught... * Appear more than once...
 ^ Pedigree continues beyond top of page...

=====
 Taxon Name: PANTHERA TIGRIS Studbook Number: 77
 =====

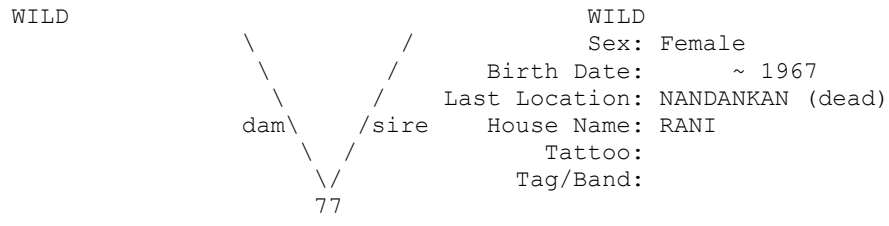

=====
 Taxon Name: PANTHERA TIGRIS Studbook Number: 80
 =====

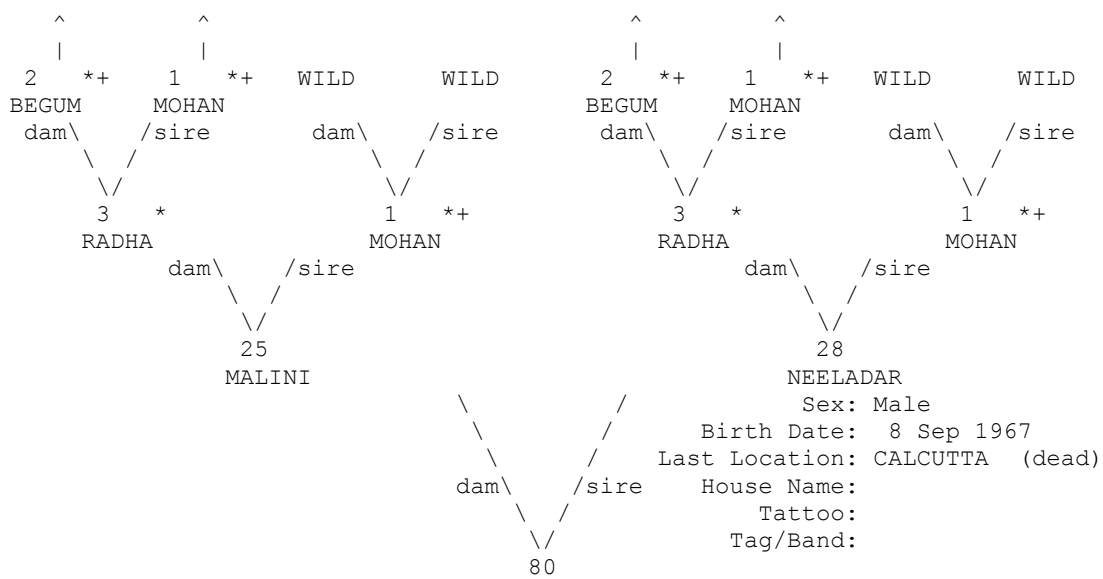

+ Wild-caught... * Appear more than once...
 ^ Pedigree continues beyond top of page...

=====
 Taxon Name: PANTHERA TIGRIS Studbook Number: 81
 =====

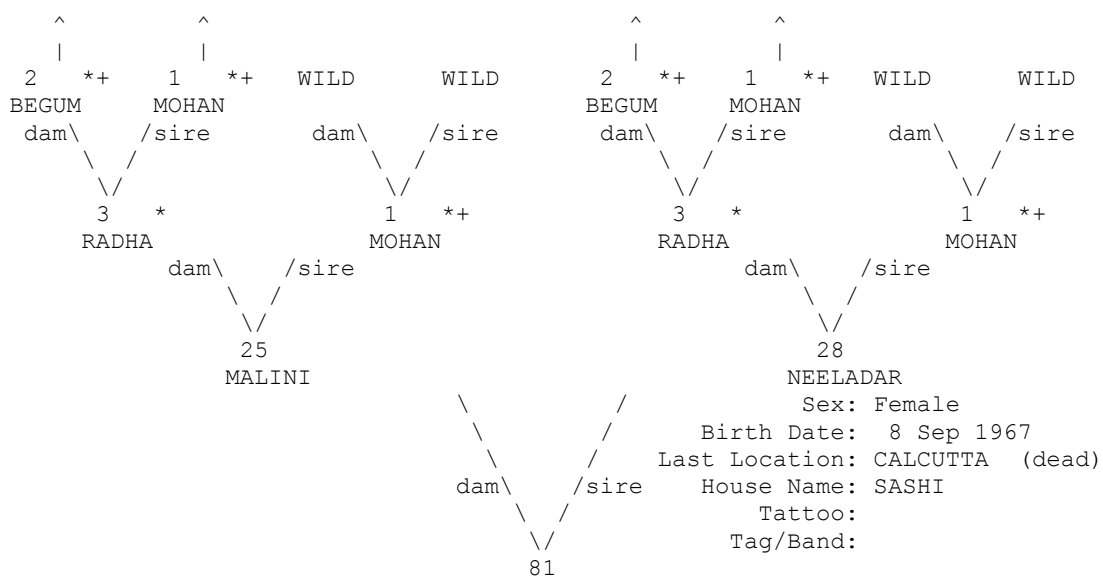

+ Wild-caught... * Appear more than once...
 ^ Pedigree continues beyond top of page...

=====
 Taxon Name: PANTHERA TIGRIS Studbook Number: 82
 =====

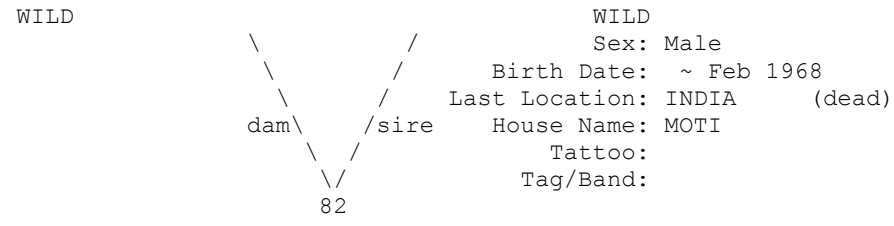

=====
 Taxon Name: PANTHERA TIGRIS Studbook Number: 83
 =====

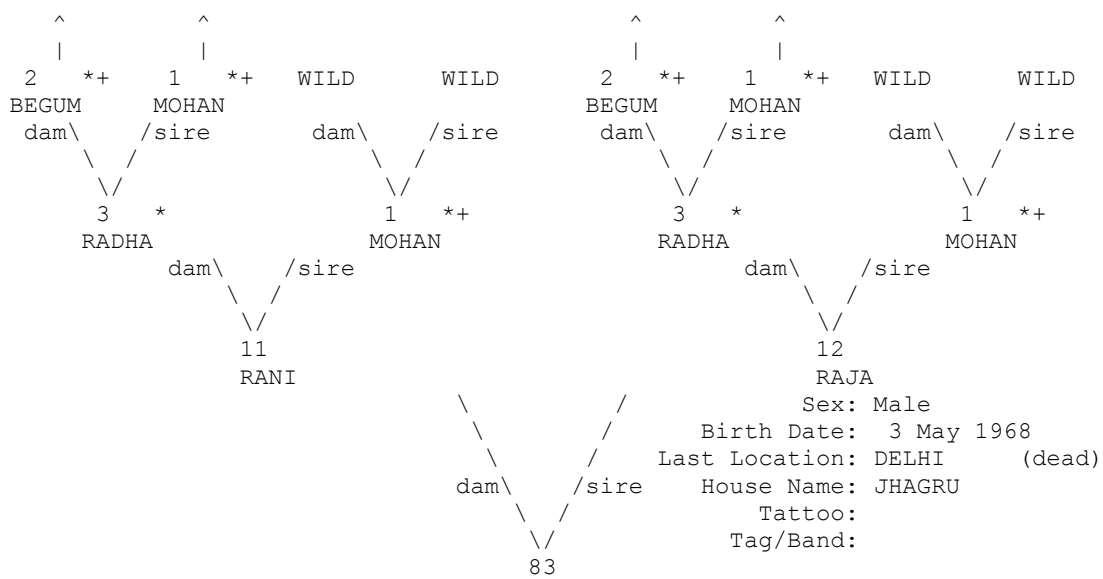

+ Wild-caught... * Appear more than once...
 ^ Pedigree continues beyond top of page...

=====
 Taxon Name: PANTHERA TIGRIS Studbook Number: 84
 =====

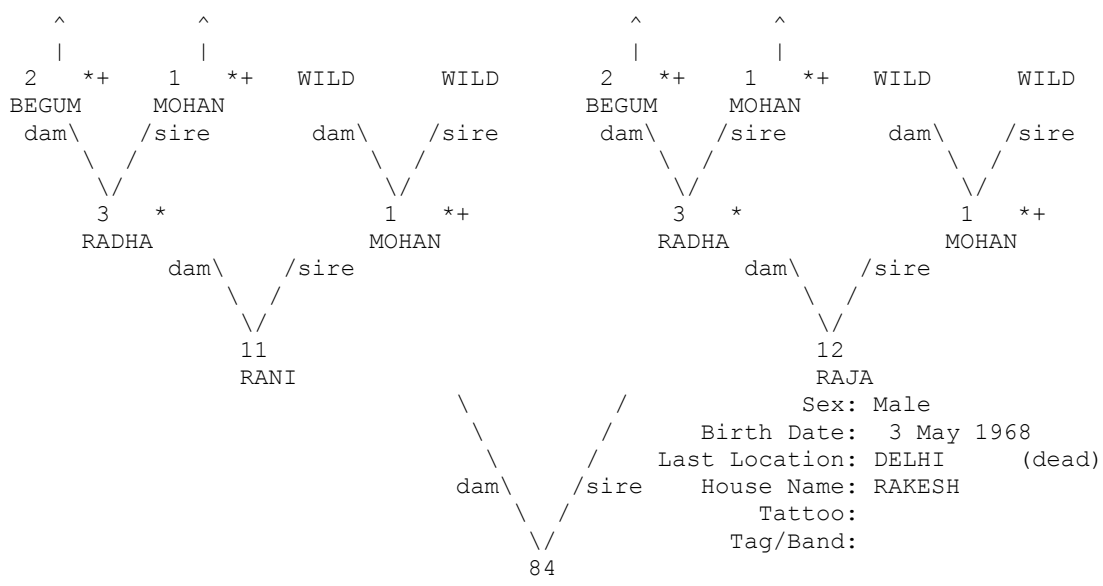

+ Wild-caught... * Appear more than once...
 ^ Pedigree continues beyond top of page...

=====
 Taxon Name: PANTHERA TIGRIS Studbook Number: 85
 =====

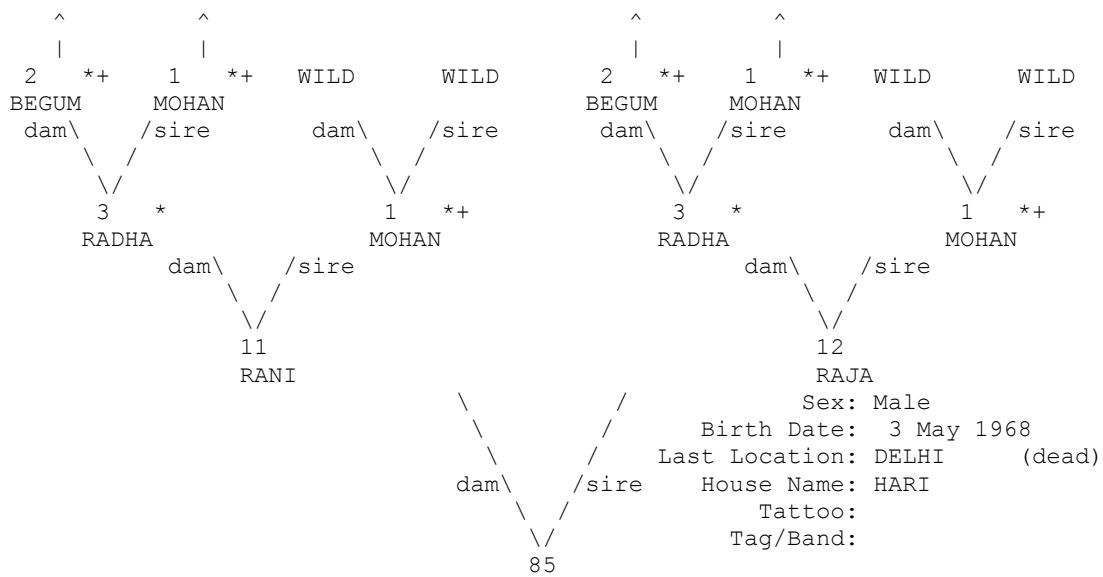

+ Wild-caught... * Appear more than once...
 ^ Pedigree continues beyond top of page...

=====
 Taxon Name: PANTHERA TIGRIS Studbook Number: 86
 =====

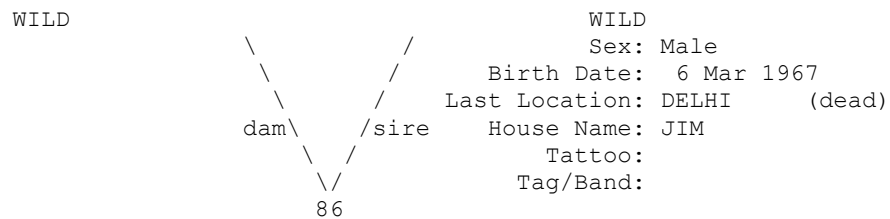

=====
 Taxon Name: PANTHERA TIGRIS Studbook Number: 87
 =====

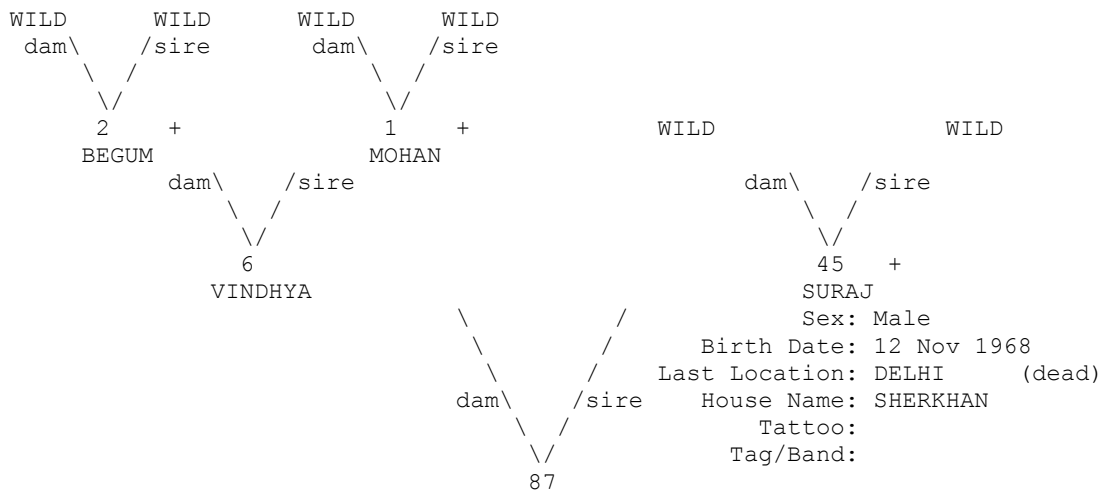

+ Wild-caught...

=====
 Taxon Name: PANTHERA TIGRIS Studbook Number: 95
 =====

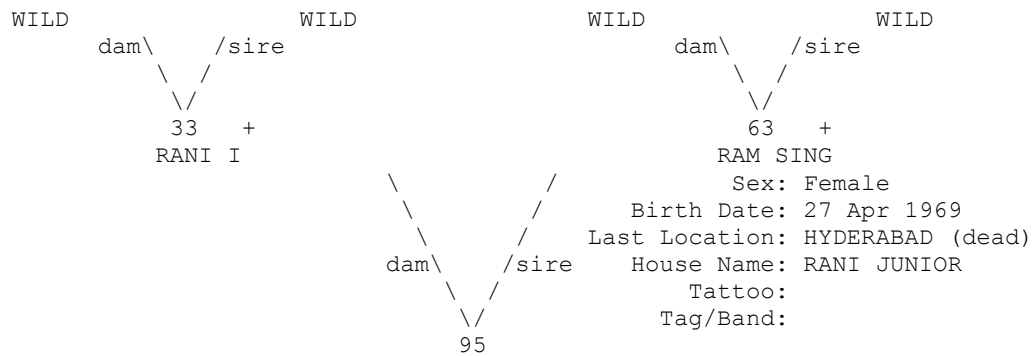

+ Wild-caught...

=====
 Taxon Name: PANTHERA TIGRIS Studbook Number: 97
 =====

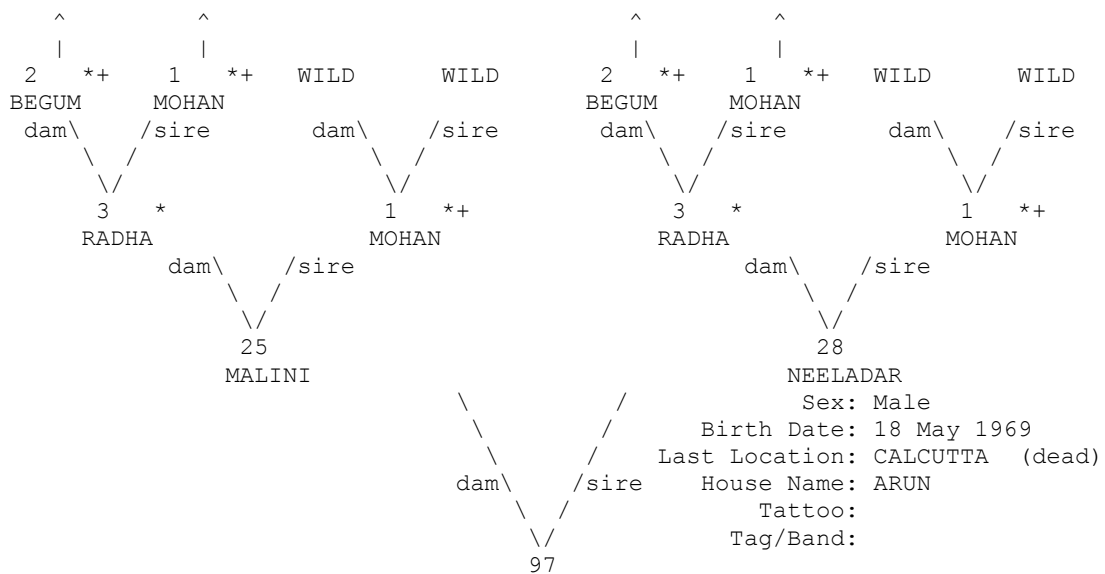

+ Wild-caught... * Appear more than once...
 ^ Pedigree continues beyond top of page...

=====
 Taxon Name: PANTHERA TIGRIS Studbook Number: 98
 =====

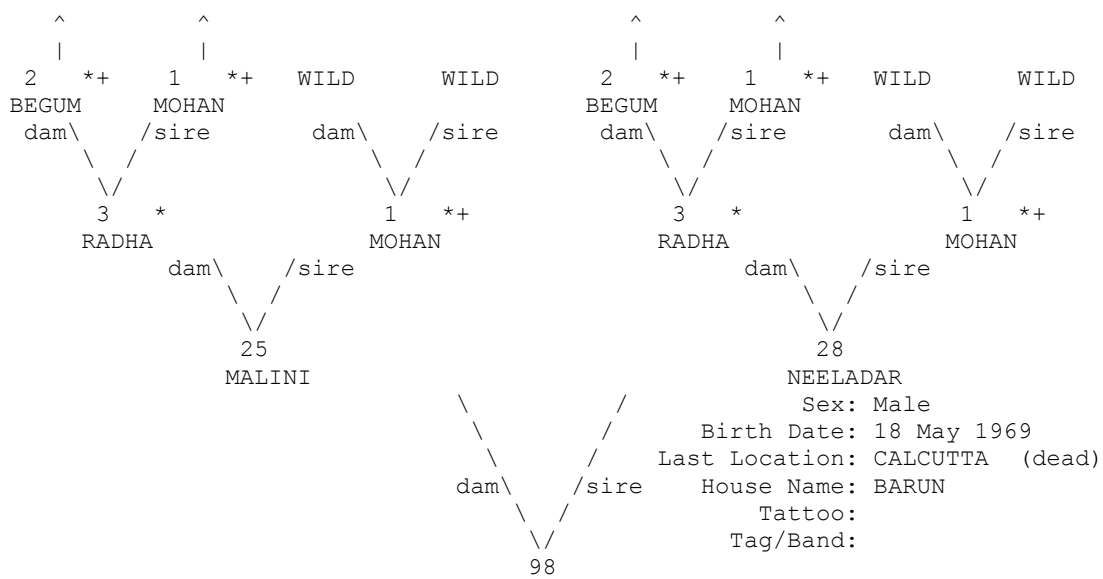

Sex: Male
 Birth Date: 18 May 1969
 Last Location: CALCUTTA (dead)
 House Name: BARUN
 Tattoo:
 Tag/Band:

+ Wild-caught... * Appear more than once...
 ^ Pedigree continues beyond top of page...

=====
 Taxon Name: PANTHERA TIGRIS Studbook Number: 99
 =====

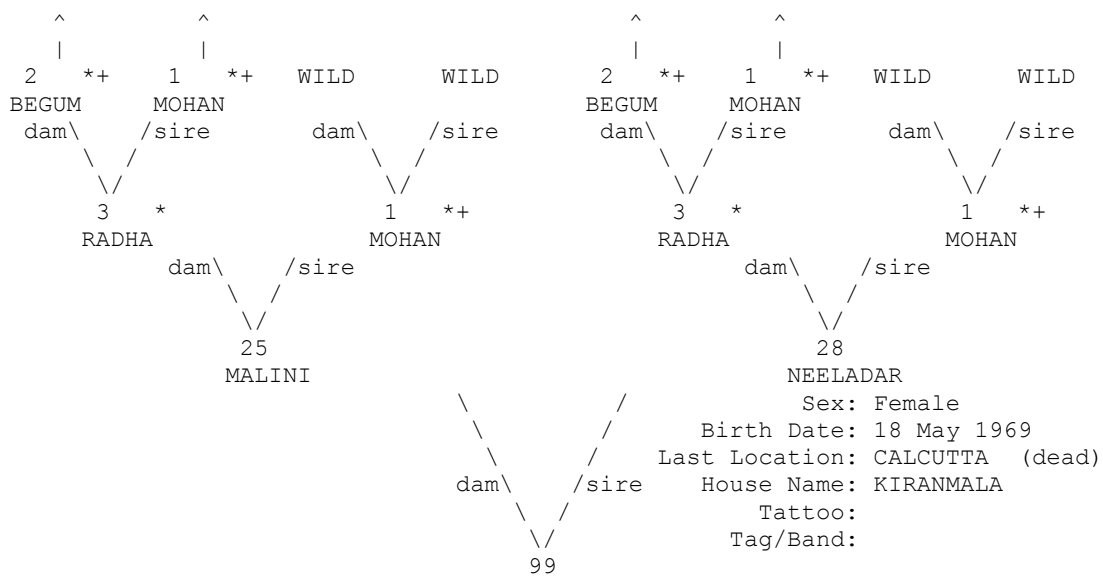

Sex: Female
 Birth Date: 18 May 1969
 Last Location: CALCUTTA (dead)
 House Name: KIRANMALA
 Tattoo:
 Tag/Band:

+ Wild-caught... * Appear more than once...
 ^ Pedigree continues beyond top of page...

=====
 Taxon Name: PANTHERA TIGRIS Studbook Number: 102
 =====

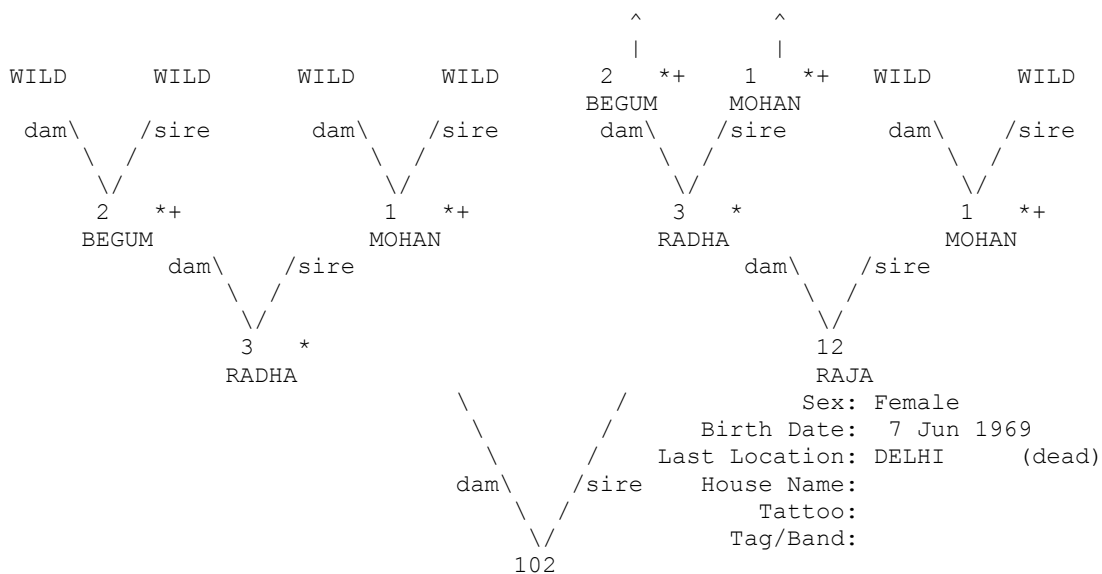

+ Wild-caught... * Appear more than once...
 ^ Pedigree continues beyond top of page...

=====
 Taxon Name: PANTHERA TIGRIS Studbook Number: 103
 =====

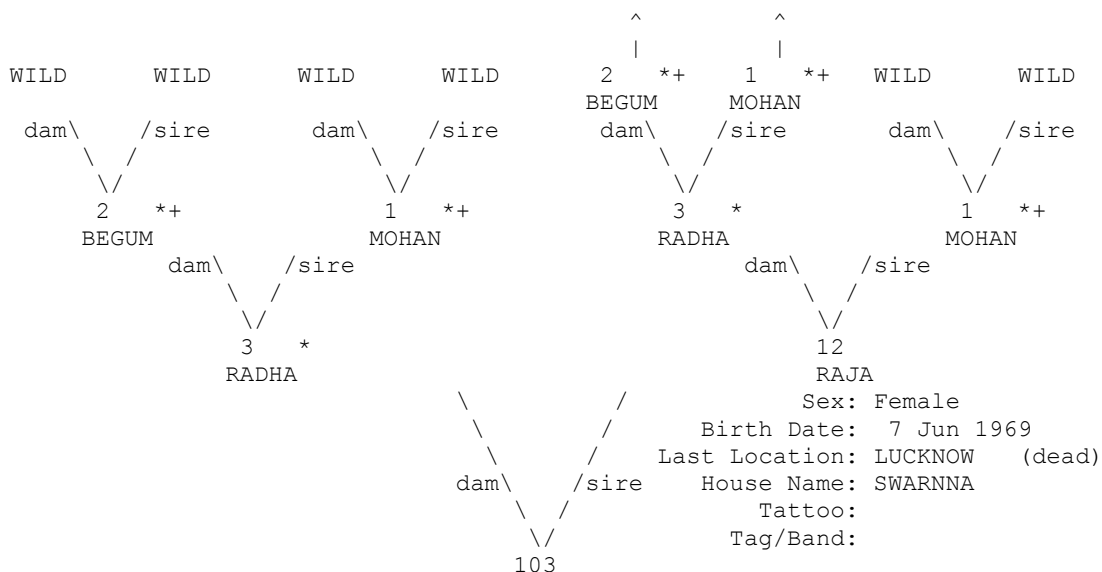

+ Wild-caught... * Appear more than once...
 ^ Pedigree continues beyond top of page...

=====
 Taxon Name: PANTHERA TIGRIS Studbook Number: 104
 =====

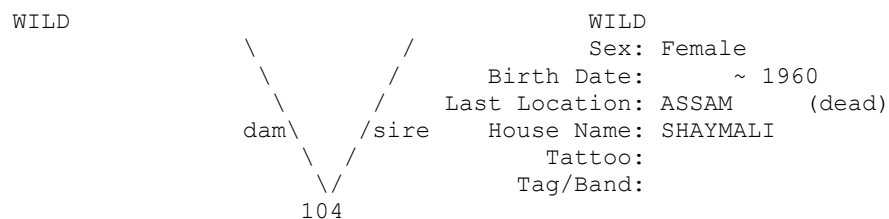

=====
 Taxon Name: PANTHERA TIGRIS Studbook Number: 105
 =====

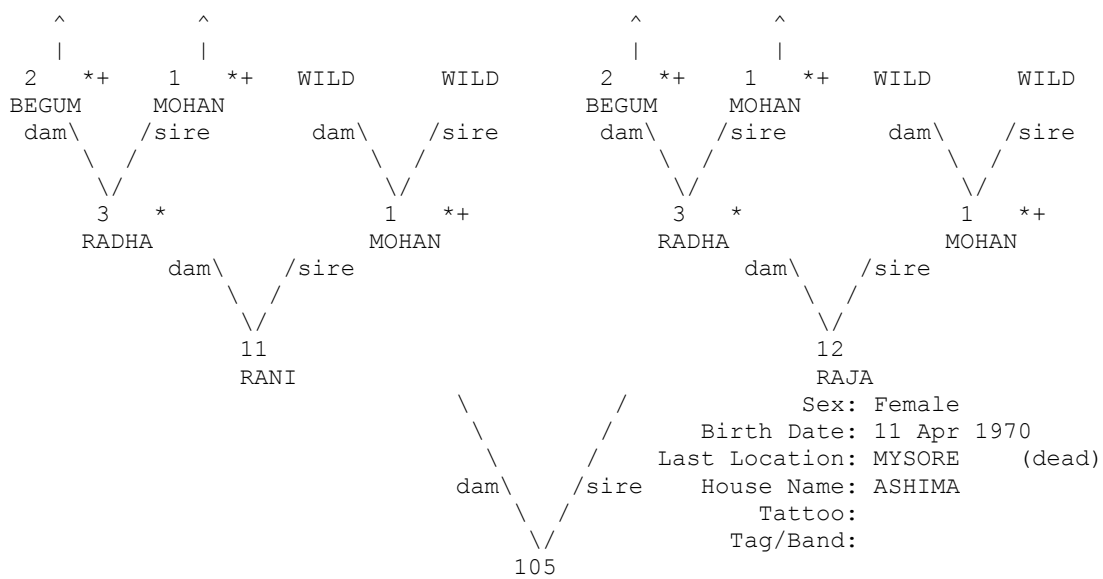

+ Wild-caught... * Appear more than once...
 ^ Pedigree continues beyond top of page...

=====
 Taxon Name: PANTHERA TIGRIS Studbook Number: 106
 =====

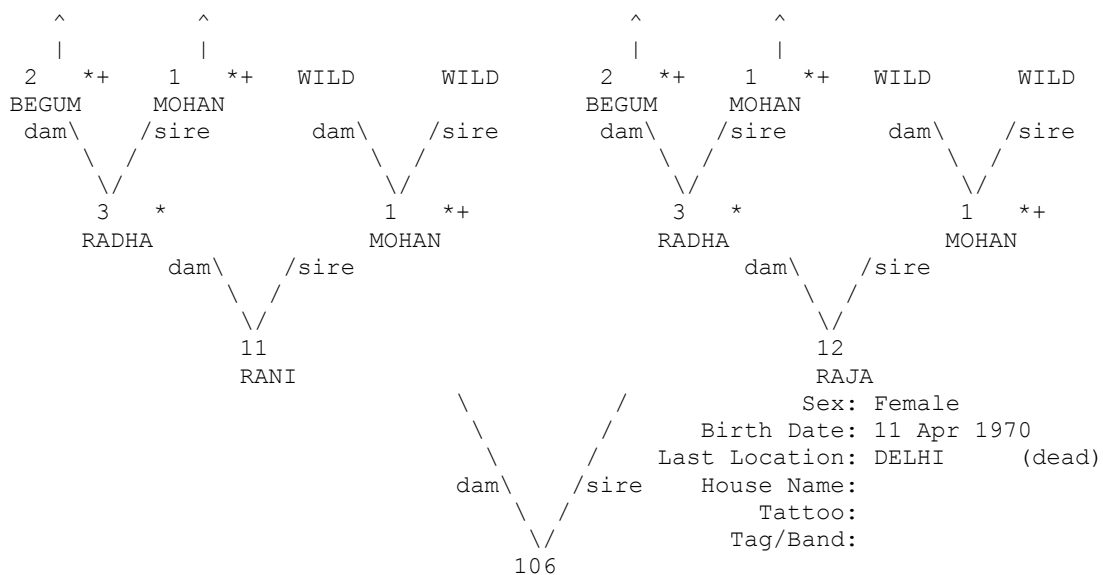

+ Wild-caught... * Appear more than once...
 ^ Pedigree continues beyond top of page...

=====
 Taxon Name: PANTHERA TIGRIS Studbook Number: 107
 =====

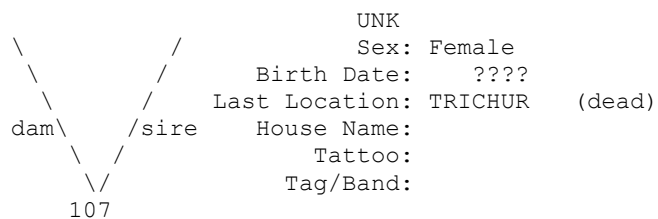

=====
 Taxon Name: PANTHERA TIGRIS Studbook Number: 108
 =====

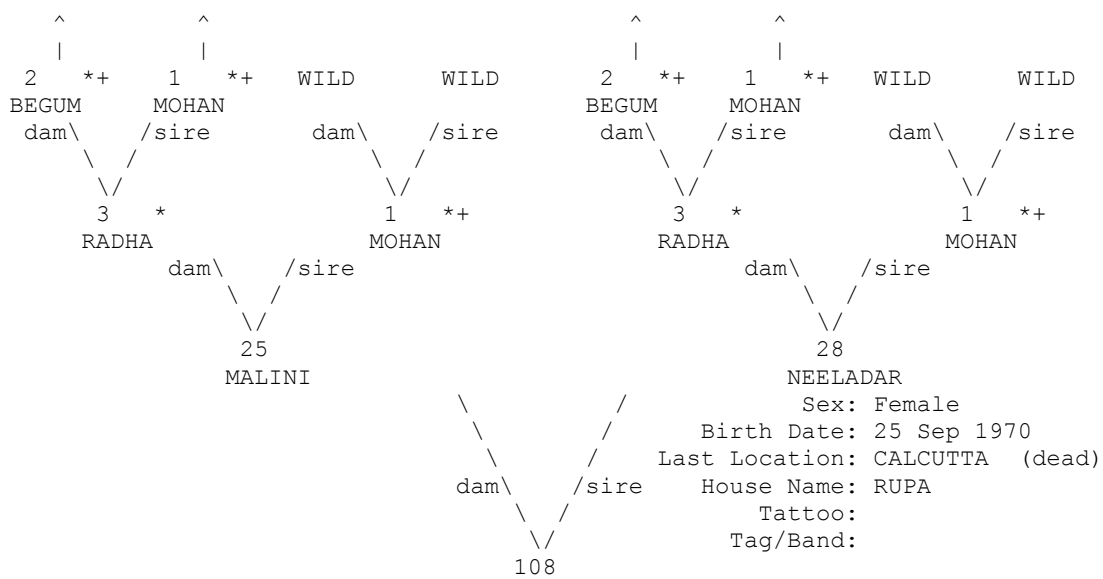

+ Wild-caught... * Appear more than once...
 ^ Pedigree continues beyond top of page...

=====
 Taxon Name: PANTHERA TIGRIS Studbook Number: 109
 =====

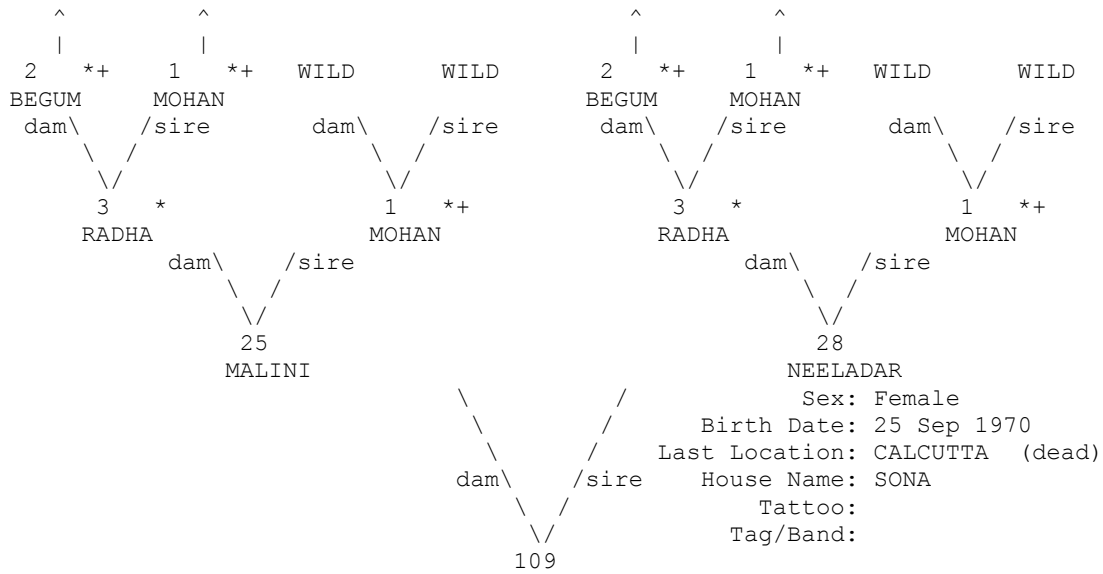

+ Wild-caught... * Appear more than once...
 ^ Pedigree continues beyond top of page...

=====
Taxon Name: PANTHERA TIGRIS Studbook Number: 110
=====

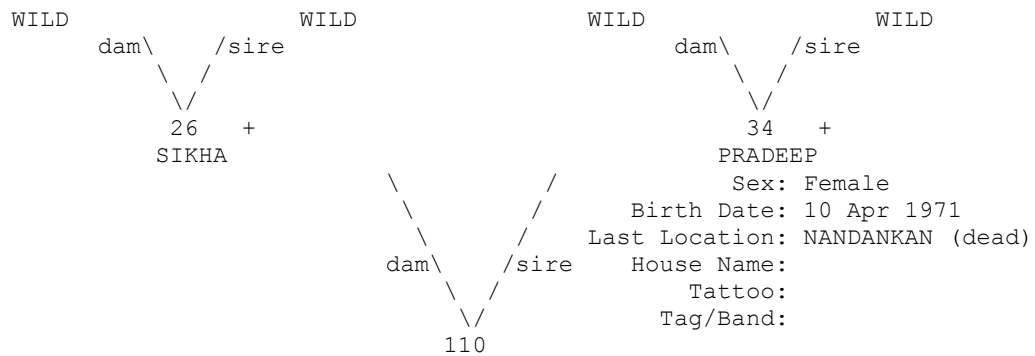

+ Wild-caught...

=====
Taxon Name: PANTHERA TIGRIS Studbook Number: 111
=====

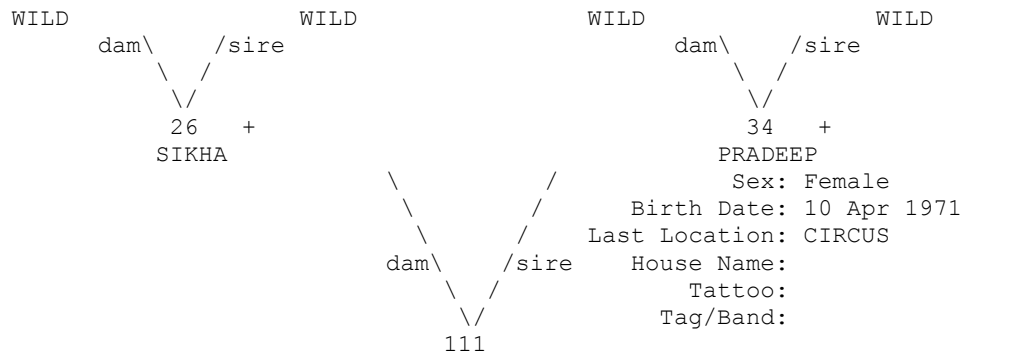

+ Wild-caught...

=====
Taxon Name: PANTHERA TIGRIS Studbook Number: 112
=====

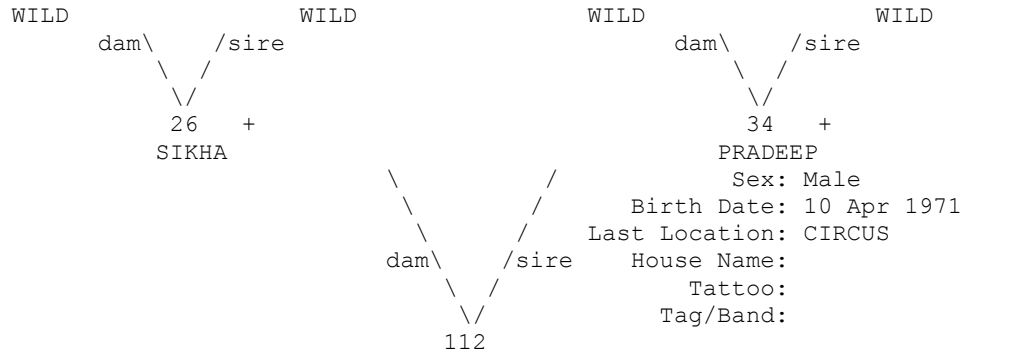

+ Wild-caught...

=====
 Taxon Name: PANTHERA TIGRIS Studbook Number: 113
 =====

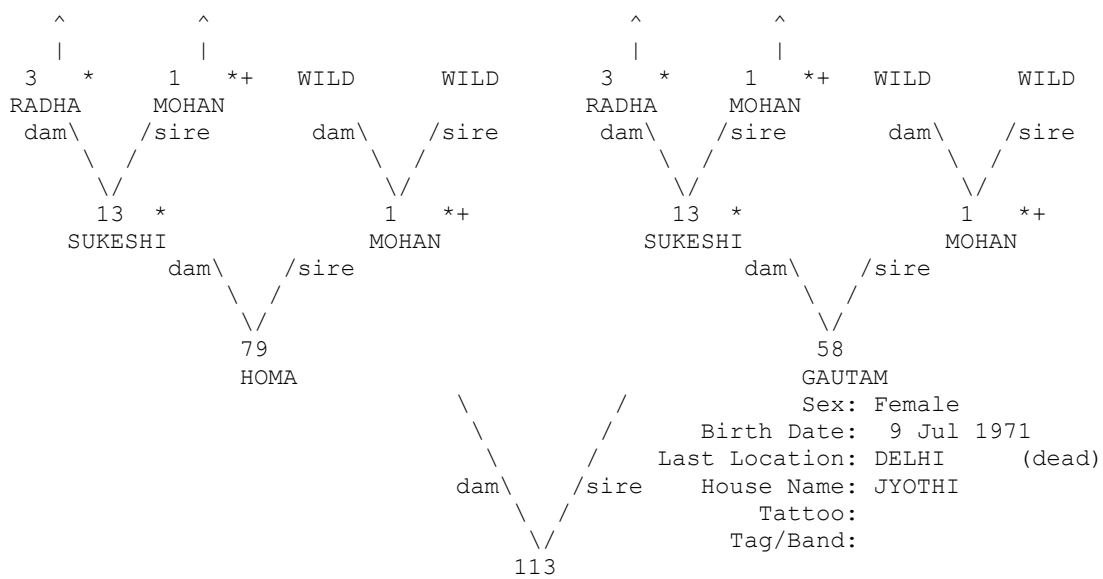

+ Wild-caught... * Appear more than once...
 ^ Pedigree continues beyond top of page...

=====
 Taxon Name: PANTHERA TIGRIS Studbook Number: 114
 =====

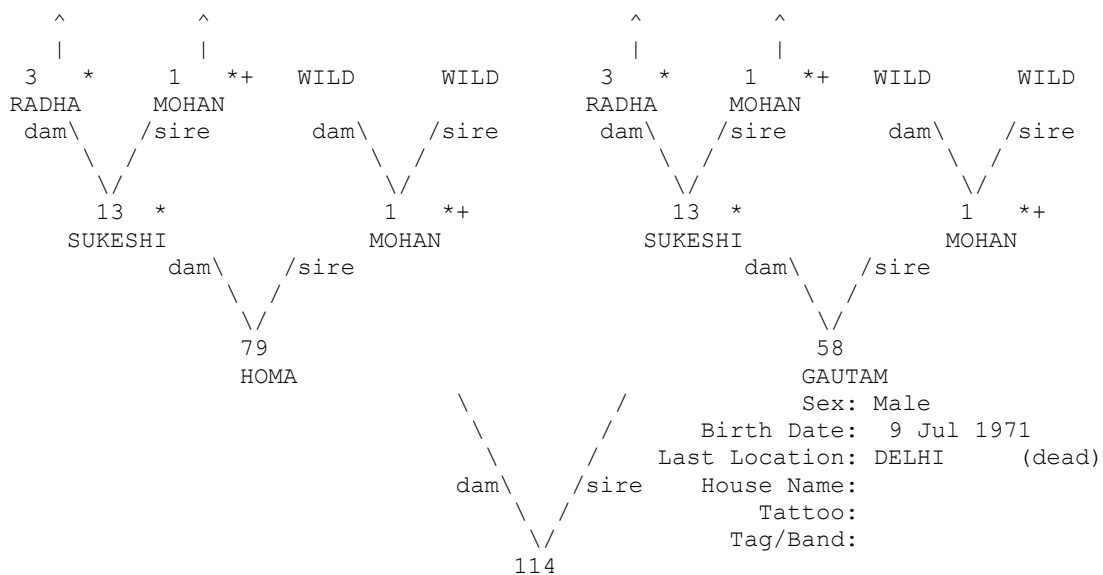

+ Wild-caught... * Appear more than once...
 ^ Pedigree continues beyond top of page...

=====
 Taxon Name: PANTHERA TIGRIS Studbook Number: 115
 =====

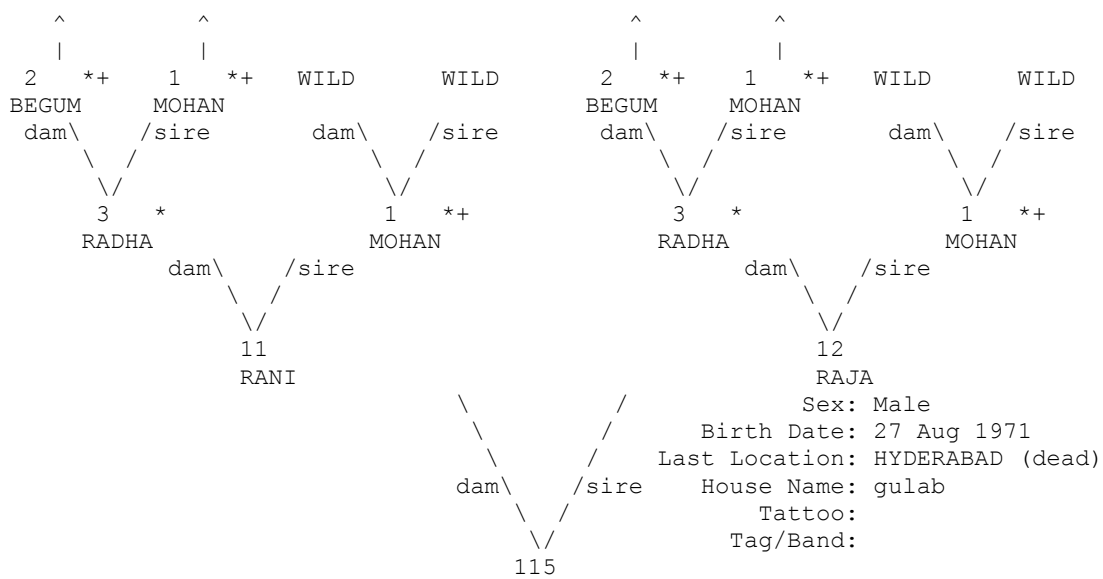

+ Wild-caught... * Appear more than once...
 ^ Pedigree continues beyond top of page...

=====
 Taxon Name: PANTHERA TIGRIS Studbook Number: 116
 =====

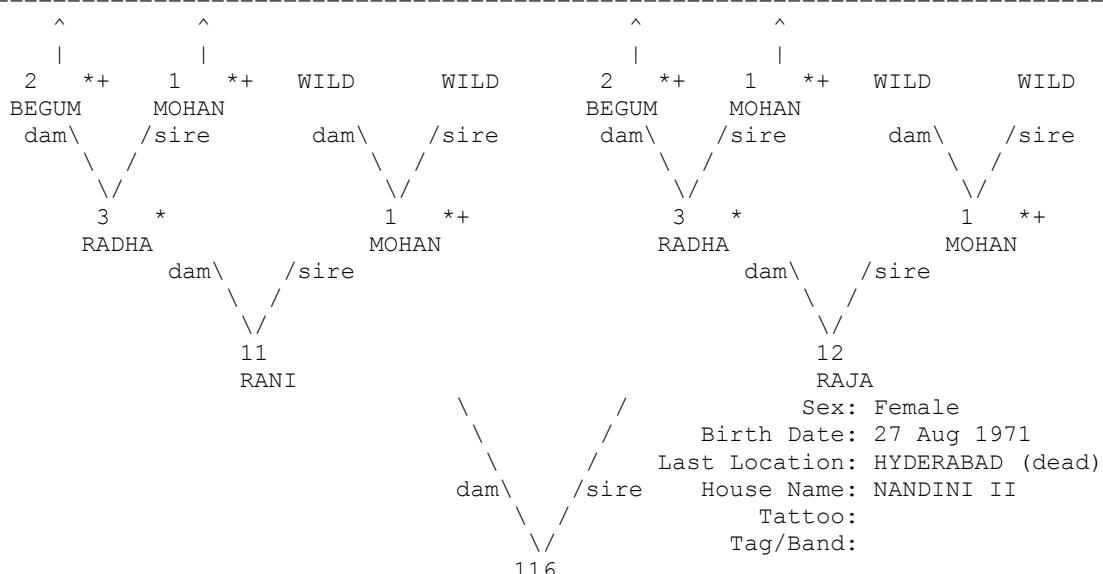

+ Wild-caught... * Appear more than once...
 ^ Pedigree continues beyond top of page...

=====
 Taxon Name: PANTHERA TIGRIS Studbook Number: 117
 =====

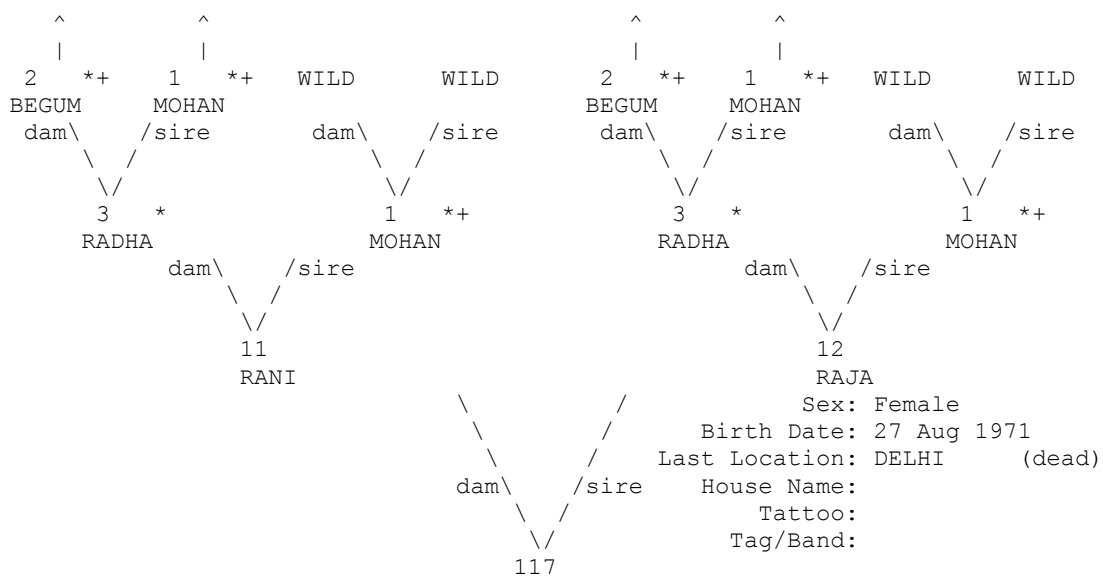

Sex: Female
 Birth Date: 27 Aug 1971
 Last Location: DELHI (dead)
 House Name:
 Tattoo:
 Tag/Band:

+ Wild-caught... * Appear more than once...
 ^ Pedigree continues beyond top of page...

=====
 Taxon Name: PANTHERA TIGRIS Studbook Number: 118
 =====

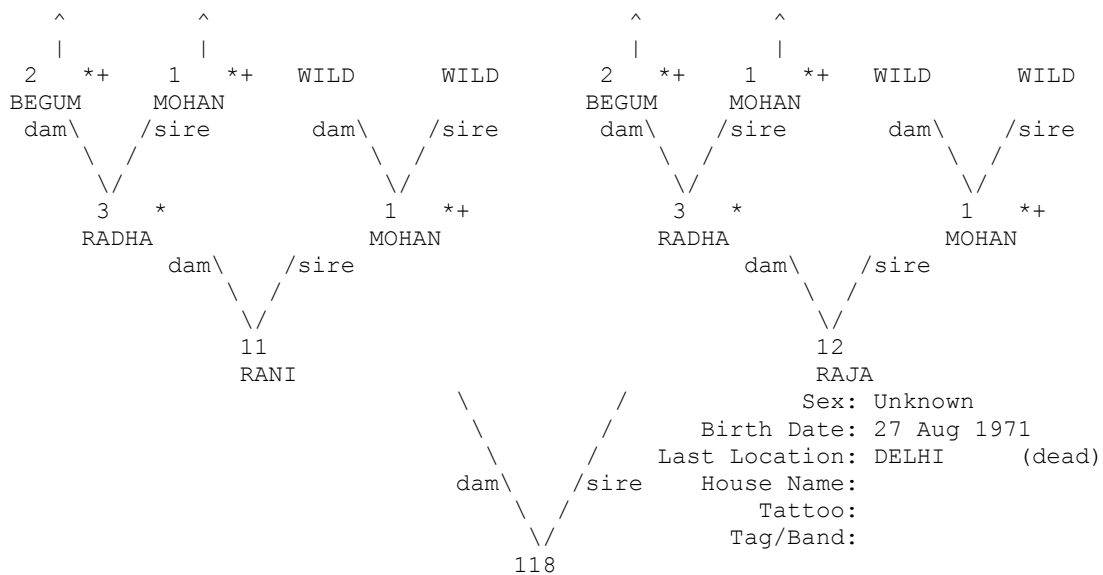

Sex: Unknown
 Birth Date: 27 Aug 1971
 Last Location: DELHI (dead)
 House Name:
 Tattoo:
 Tag/Band:

+ Wild-caught... * Appear more than once...
 ^ Pedigree continues beyond top of page...

=====
 Taxon Name: PANTHERA TIGRIS Studbook Number: 119
 =====

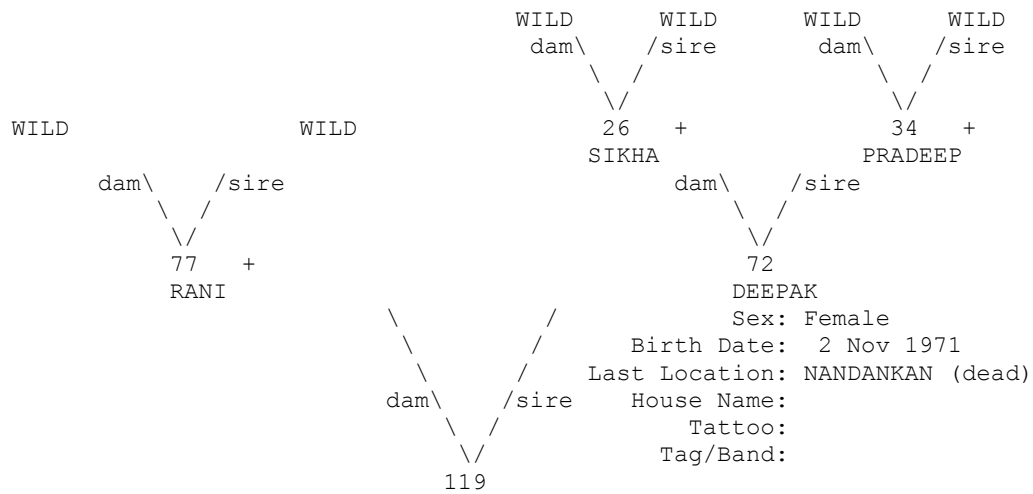

+ Wild-caught...

=====
 Taxon Name: PANTHERA TIGRIS Studbook Number: 120
 =====

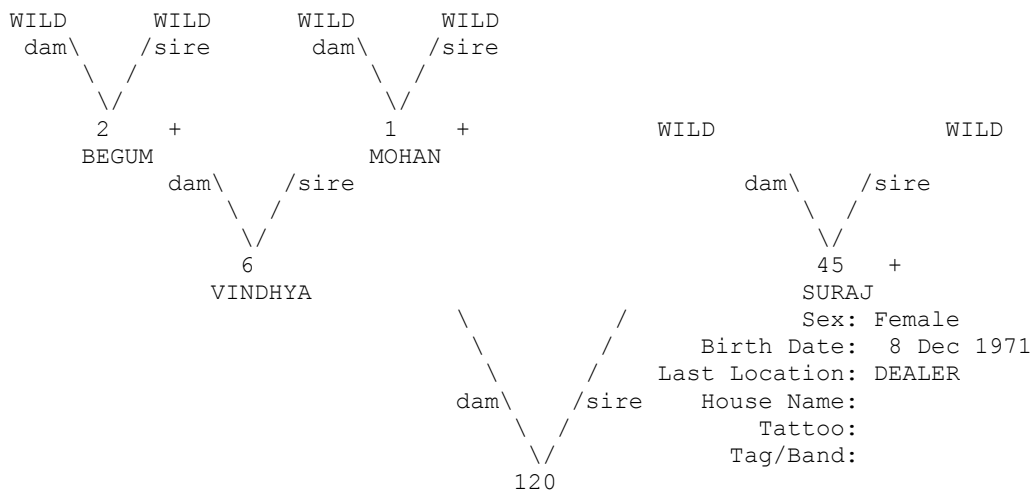

+ Wild-caught...

=====
 Taxon Name: PANTHERA TIGRIS Studbook Number: 121
 =====

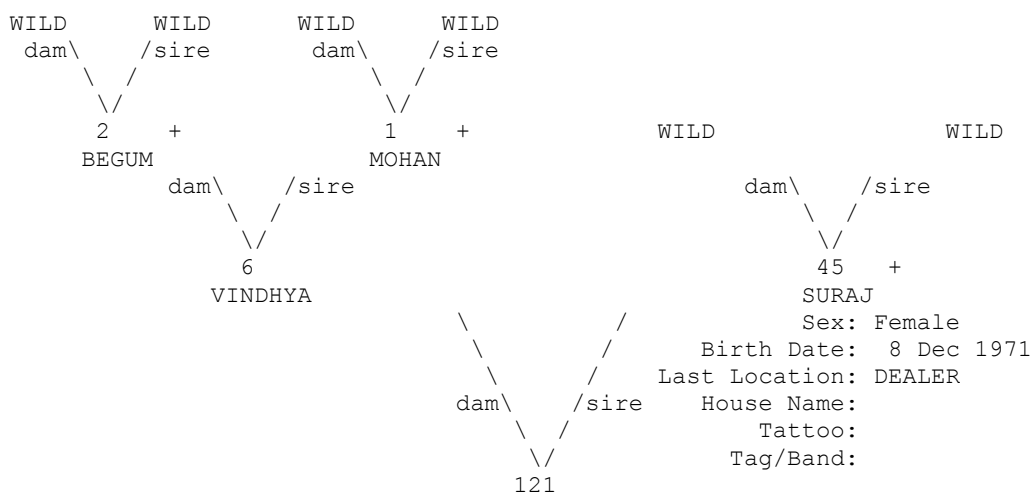

+ Wild-caught...

```

=====
Taxon Name: PANTHERA TIGRIS                      Studbook Number: 122
=====
WILD
dam \ /
  \ /
   V
  122
/ sire
WILD
Sex: Male
Birth Date: ~ 1972
Last Location: HYDERABAD (dead)
House Name: RAJA
Tattoo:
Tag/Band:

```

```

=====
Taxon Name: PANTHERA TIGRIS                      Studbook Number: 123
=====
WILD dam \ / WILD dam \ / WILD dam \ / WILD dam \ /
  \ / sire  \ / sire  \ / sire  \ / sire
   V         V         V         V
  77 +      26 +      34 +
  RANI      SIKHA    PRADEEP
              dam \ /
                \ /
                 V
                72
                DEEPAK
              Sex: Female
              Birth Date: 2 Apr 1972
              Last Location: MYSORE (dead)
              House Name: THARA
              Tattoo:
              Tag/Band:
dam \ /
  \ /
   V
  123
/ sire

```

+ Wild-caught...

```

=====
Taxon Name: PANTHERA TIGRIS                      Studbook Number: 124
=====
WILD dam \ / WILD dam \ / WILD dam \ / WILD dam \ /
  \ / sire  \ / sire  \ / sire  \ / sire
   V         V         V         V
  77 +      26 +      34 +
  RANI      SIKHA    PRADEEP
              dam \ /
                \ /
                 V
                72
                DEEPAK
              Sex: Female
              Birth Date: 2 Apr 1972
              Last Location: DEALER
              House Name:
              Tattoo:
              Tag/Band:
dam \ /
  \ /
   V
  124
/ sire

```

+ Wild-caught...

=====
 Taxon Name: PANTHERA TIGRIS Studbook Number: 127
 =====

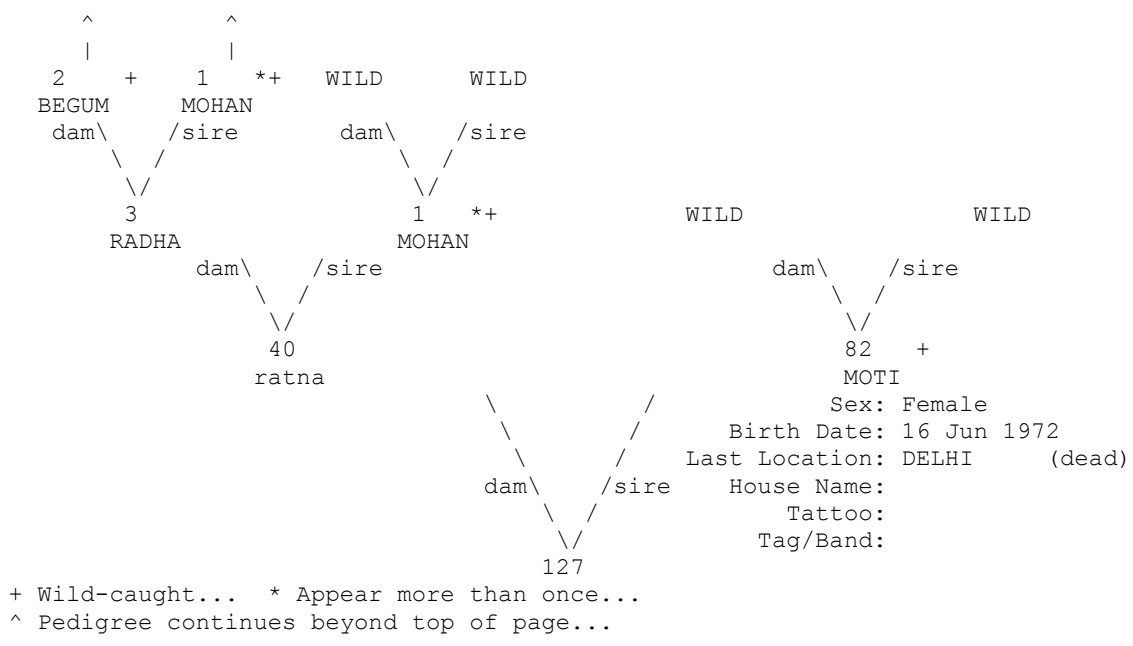

=====
 Taxon Name: PANTHERA TIGRIS Studbook Number: 128
 =====

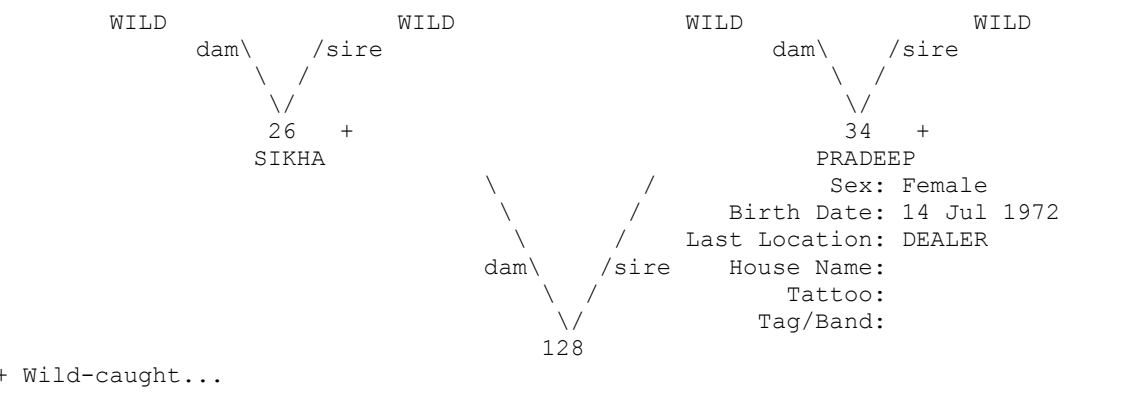

=====
 Taxon Name: PANTHERA TIGRIS Studbook Number: 129
 =====

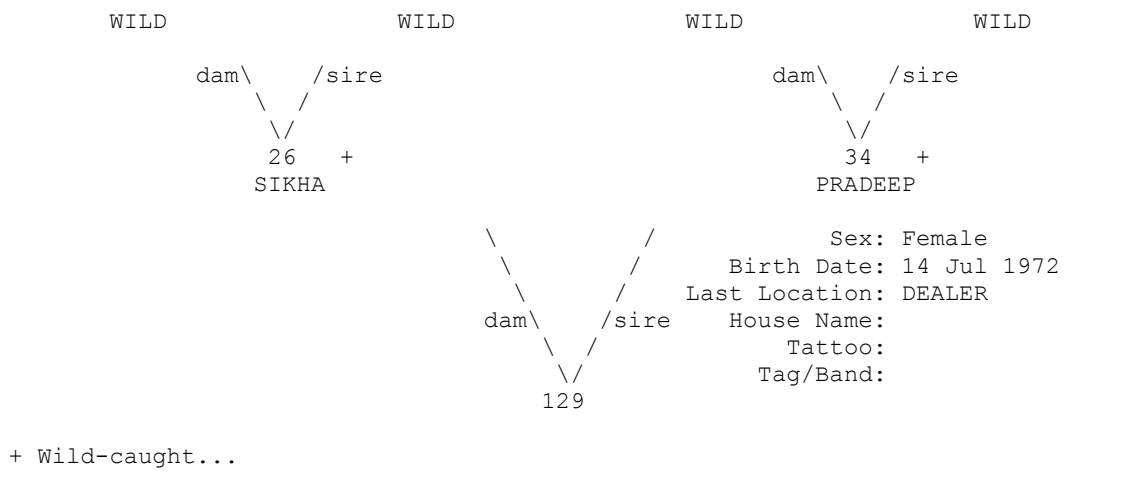

=====
 Taxon Name: PANTHERA TIGRIS Studbook Number: 133
 =====

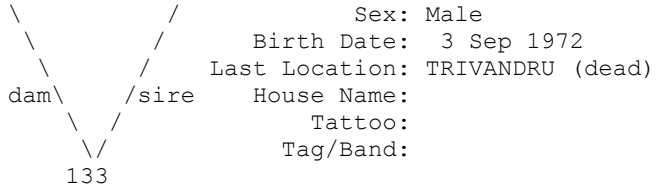
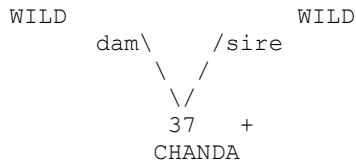

+ Wild-caught...

=====
 Taxon Name: PANTHERA TIGRIS Studbook Number: 134
 =====

UNK

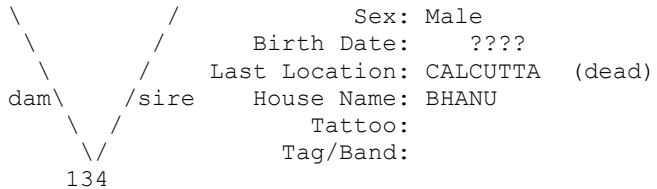

=====
 Taxon Name: PANTHERA TIGRIS Studbook Number: 135
 =====

WILD

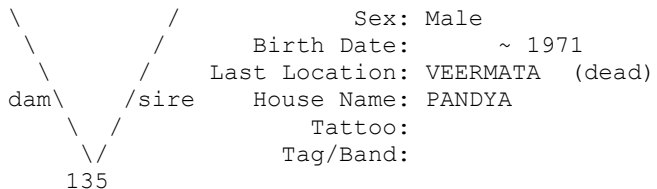

=====
 Taxon Name: PANTHERA TIGRIS Studbook Number: 136
 =====

WILD

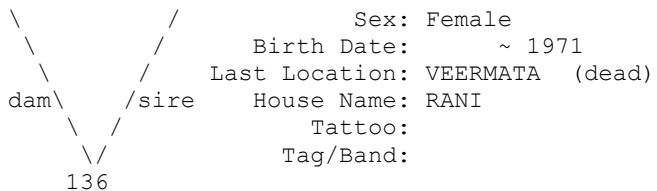

=====
 Taxon Name: PANTHERA TIGRIS Studbook Number: 137
 =====

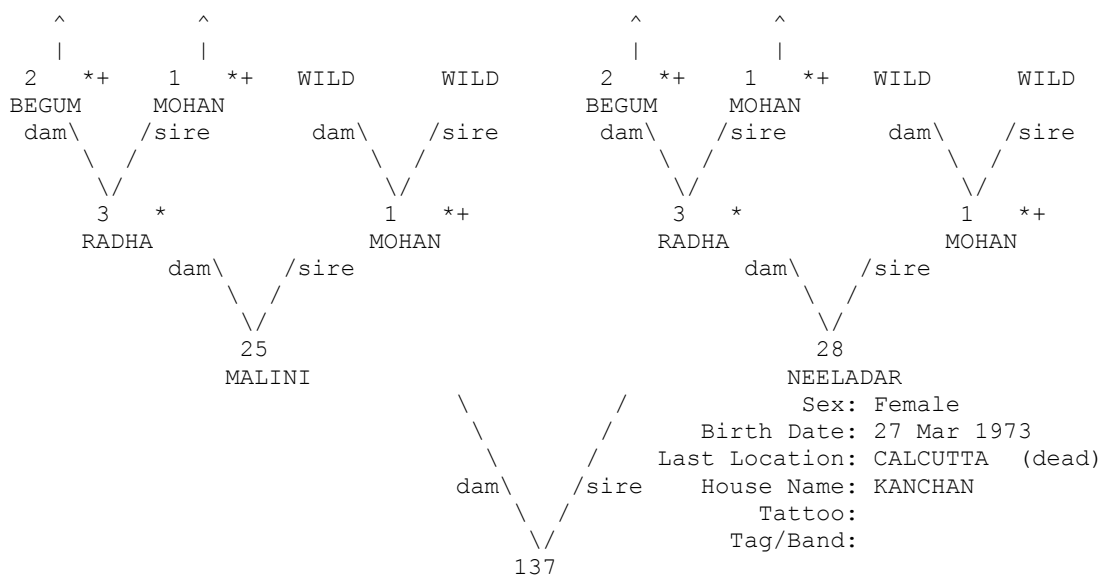

+ Wild-caught... * Appear more than once...
 ^ Pedigree continues beyond top of page...

=====
 Taxon Name: PANTHERA TIGRIS Studbook Number: 138
 =====

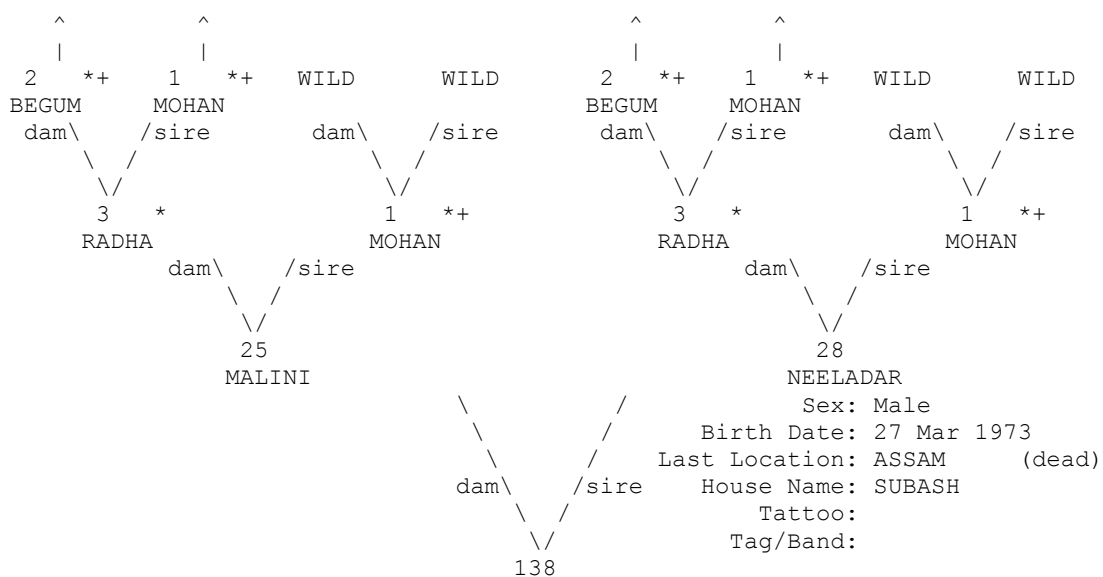

+ Wild-caught... * Appear more than once...
 ^ Pedigree continues beyond top of page...

=====
 Taxon Name: PANTHERA TIGRIS Studbook Number: 139
 =====

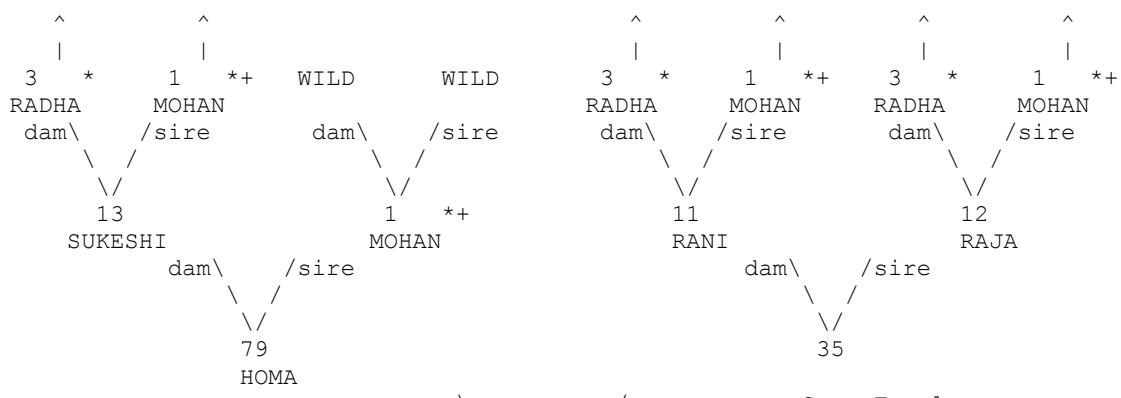

Sex: Female
 Birth Date: 30 May 1973
 Last Location: DELHI (dead)
 House Name:
 Tattoo:
 Tag/Band:

+ Wild-caught... * Appear more than once...
 ^ Pedigree continues beyond top of page...

=====
 Taxon Name: PANTHERA TIGRIS Studbook Number: 140
 =====

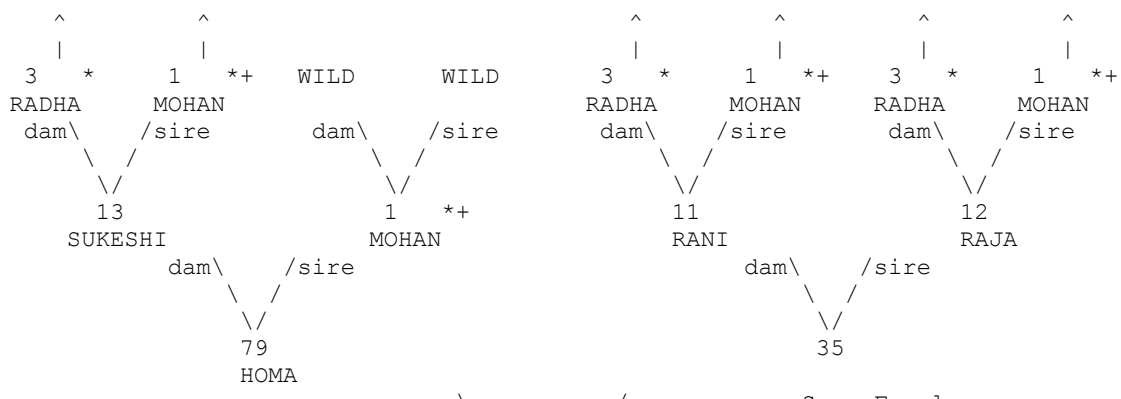

Sex: Female
 Birth Date: 30 May 1973
 Last Location: DELHI (dead)
 House Name:
 Tattoo:
 Tag/Band:

+ Wild-caught... * Appear more than once...
 ^ Pedigree continues beyond top of page...

=====
 Taxon Name: PANTHERA TIGRIS Studbook Number: 141
 =====

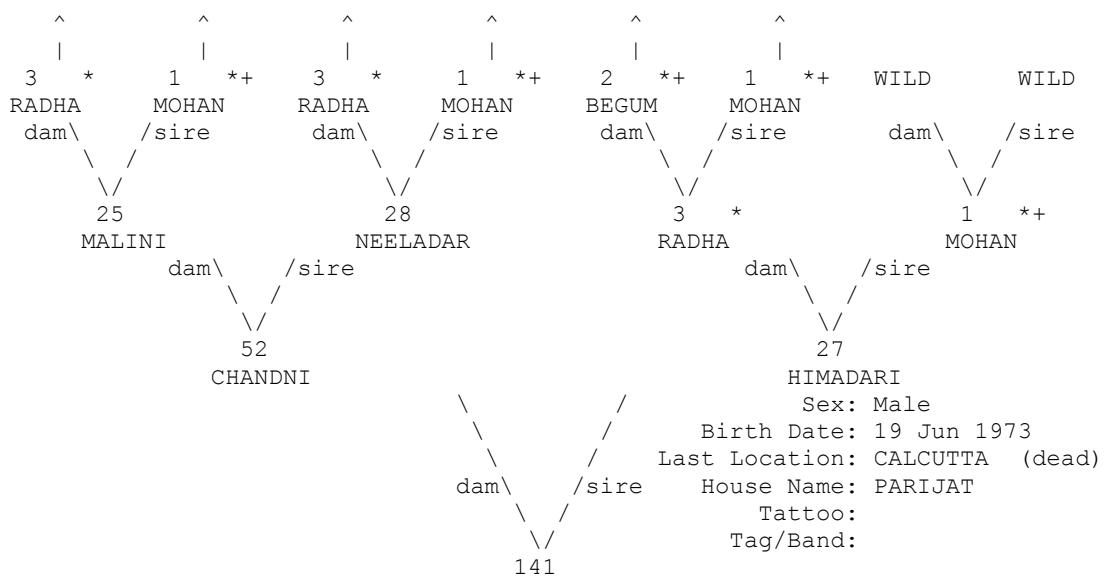

+ Wild-caught... * Appear more than once...
 ^ Pedigree continues beyond top of page...

=====
 Taxon Name: PANTHERA TIGRIS Studbook Number: 142
 =====

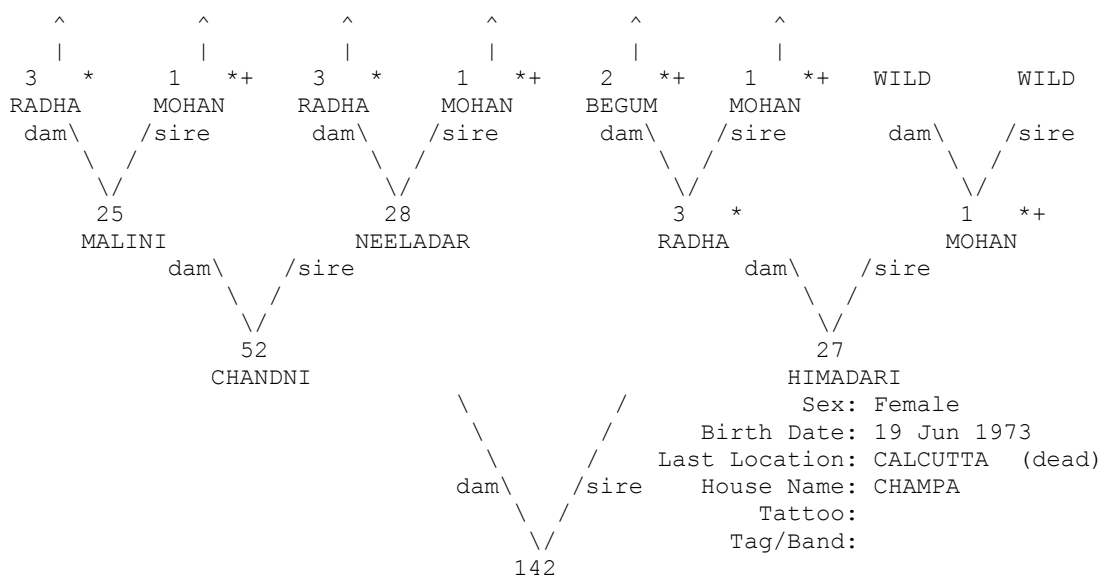

+ Wild-caught... * Appear more than once...
 ^ Pedigree continues beyond top of page...

=====
 Taxon Name: PANTHERA TIGRIS Studbook Number: 143
 =====

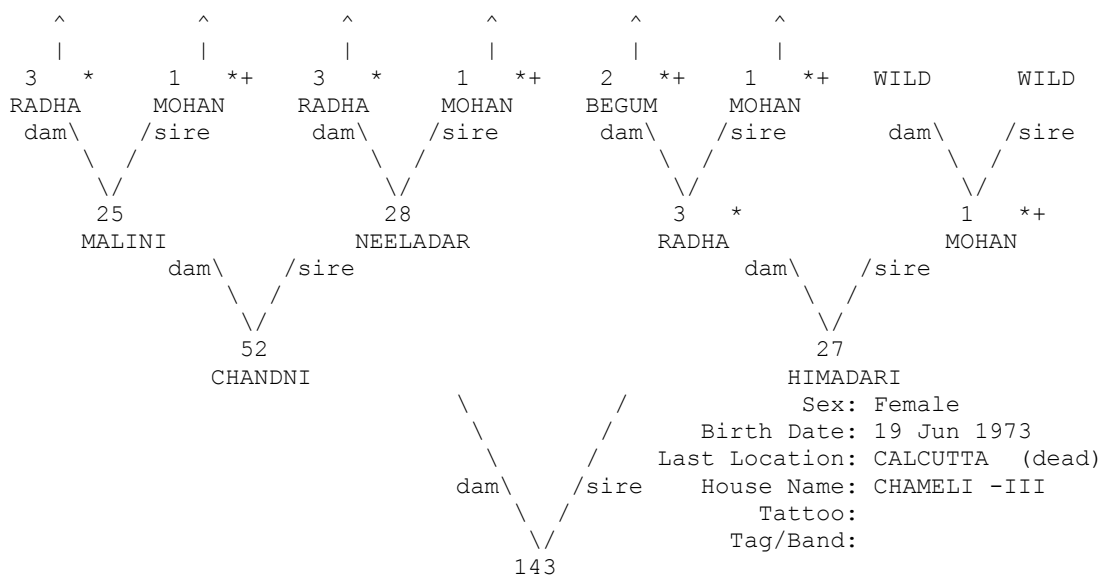

+ Wild-caught... * Appear more than once...
 ^ Pedigree continues beyond top of page...

=====
 Taxon Name: PANTHERA TIGRIS Studbook Number: 144
 =====

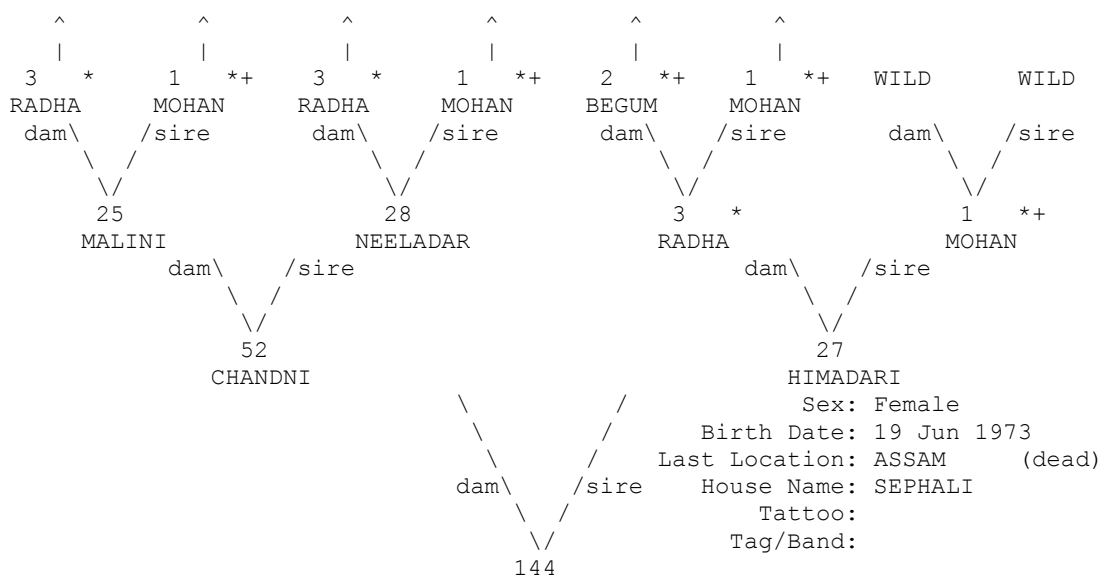

+ Wild-caught... * Appear more than once...
 ^ Pedigree continues beyond top of page...

```

=====
Taxon Name: PANTHERA TIGRIS                      Studbook Number: 149
=====
WILD                                              WILD
                                                Sex: Female
                                                Birth Date: ~ 1969
                                                Last Location: PATNA (dead)
                                                House Name: DISOI/FAUZI
                                                Tattoo:
                                                Tag/Band:
    dam \ /sire
      \ /
      149
  
```

```

=====
Taxon Name: PANTHERA TIGRIS                      Studbook Number: 150
=====
    ^           ^           ^           ^
    |           |           |           |
  3 *       1 *+   WILD   WILD   3 *       1 *+   3 *       1 *+
RADHA      MOHAN   dam \ /sire   dam \ /sire   RADHA      MOHAN   RADHA      MOHAN
 dam \ /sire   dam \ /sire   dam \ /sire   dam \ /sire   dam \ /sire   dam \ /sire
   \ /         \ /         \ /         \ /         \ /         \ /
   13         1 *+       11         12
SUKESHI      MOHAN      RANI         RAJA
   dam \ /sire   dam \ /sire   dam \ /sire
   \ /         \ /         \ /
   79         35
HOMA
    dam \ /sire
      \ /
      150
  
```

+ Wild-caught... * Appear more than once...
^ Pedigree continues beyond top of page...

```

=====
Taxon Name: PANTHERA TIGRIS                      Studbook Number: 151
=====
    ^           ^           ^           ^
    |           |           |           |
  3 *       1 *+   WILD   WILD   3 *       1 *+   3 *       1 *+
RADHA      MOHAN   dam \ /sire   dam \ /sire   RADHA      MOHAN   RADHA      MOHAN
 dam \ /sire   dam \ /sire   dam \ /sire   dam \ /sire   dam \ /sire   dam \ /sire
   \ /         \ /         \ /         \ /         \ /         \ /
   13         1 *+       11         12
SUKESHI      MOHAN      RANI         RAJA
   dam \ /sire   dam \ /sire   dam \ /sire
   \ /         \ /         \ /
   79         35
HOMA
    dam \ /sire
      \ /
      151
  
```

+ Wild-caught... * Appear more than once...
^ Pedigree continues beyond top of page...

=====
 Taxon Name: PANTHERA TIGRIS Studbook Number: 152
 =====

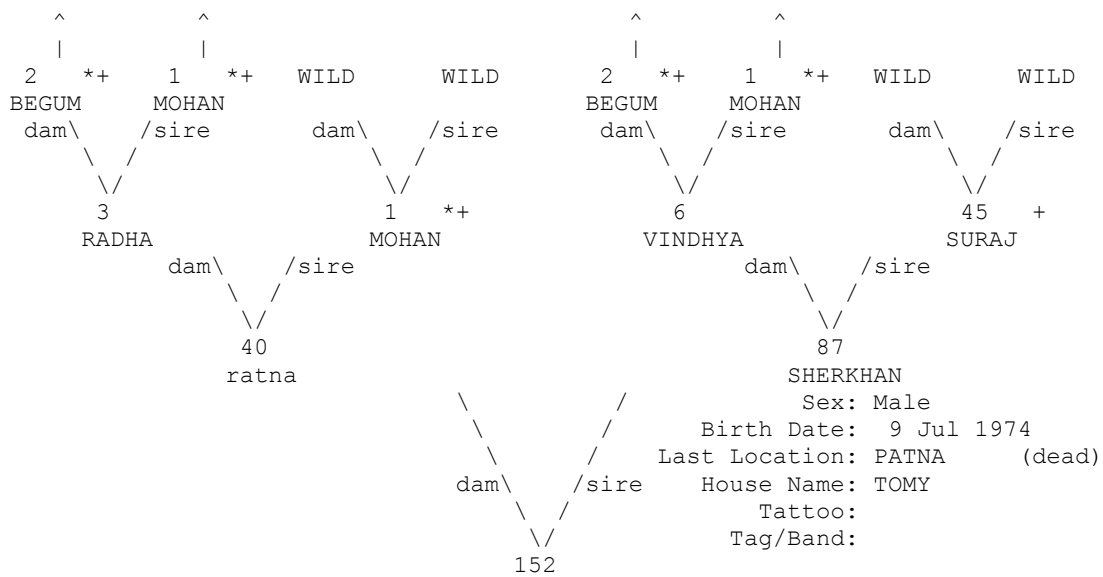

+ Wild-caught... * Appear more than once...
 ^ Pedigree continues beyond top of page...

=====
 Taxon Name: PANTHERA TIGRIS Studbook Number: 153
 =====

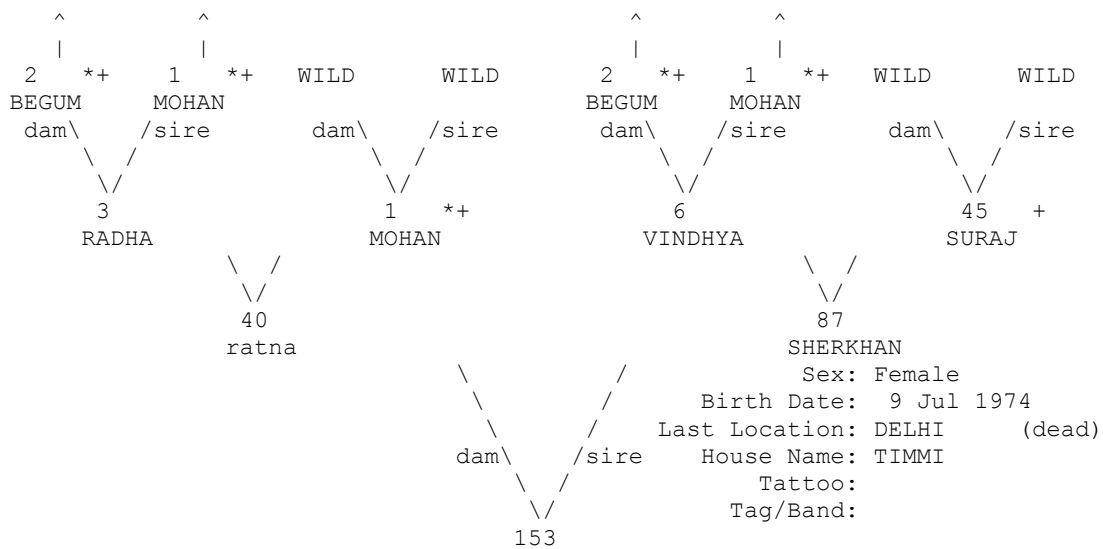

+ Wild-caught... * Appear more than once...
 ^ Pedigree continues beyond top of page...

=====
 Taxon Name: PANTHERA TIGRIS Studbook Number: 154
 =====

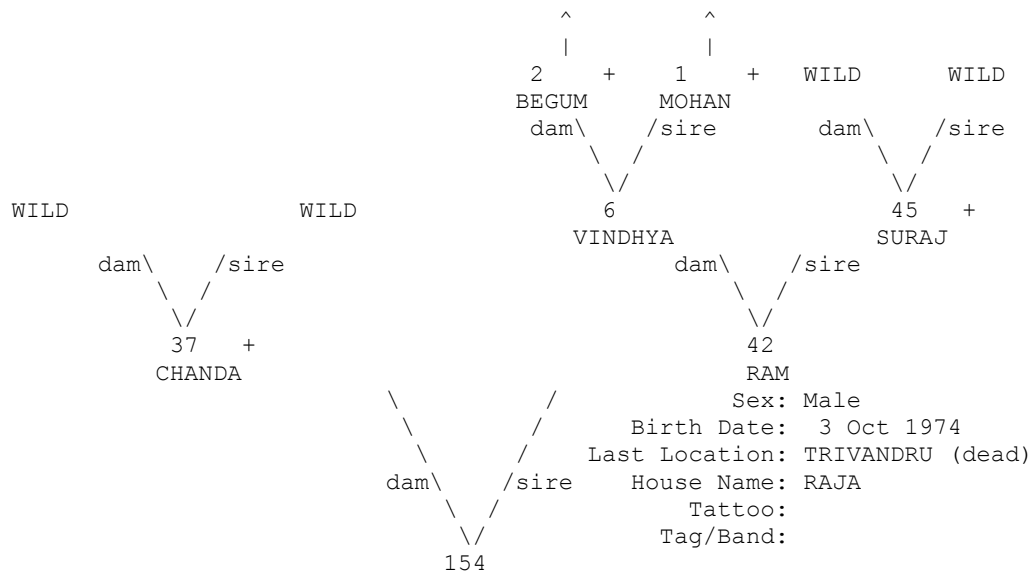

+ Wild-caught...
 ^ Pedigree continues beyond top of page...

=====
 Taxon Name: PANTHERA TIGRIS Studbook Number: 155
 =====

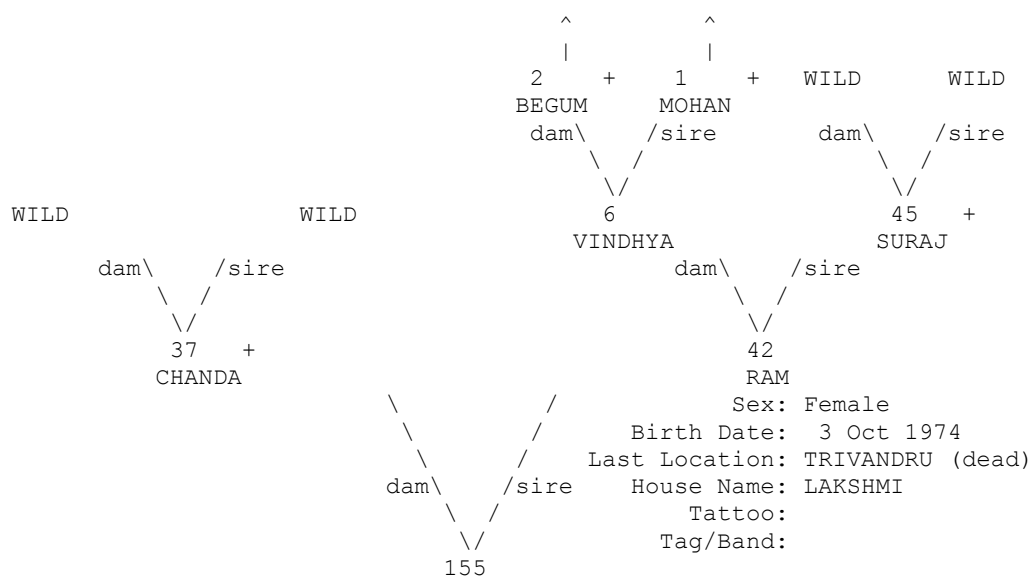

+ Wild-caught...
 ^ Pedigree continues beyond top of page...

=====
 Taxon Name: PANTHERA TIGRIS Studbook Number: 156
 =====

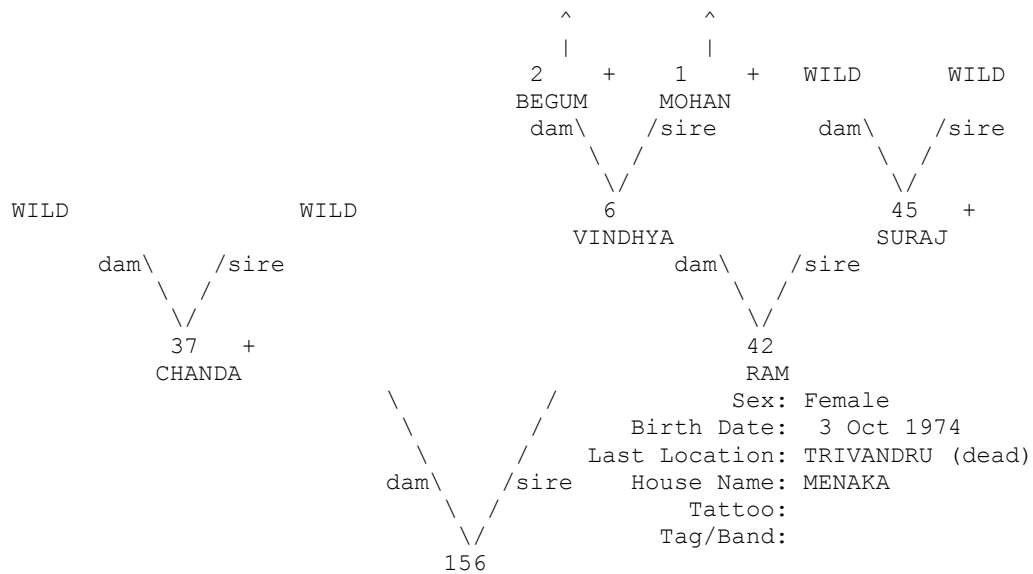

+ Wild-caught...
 ^ Pedigree continues beyond top of page...

=====
 Taxon Name: PANTHERA TIGRIS Studbook Number: 157
 =====

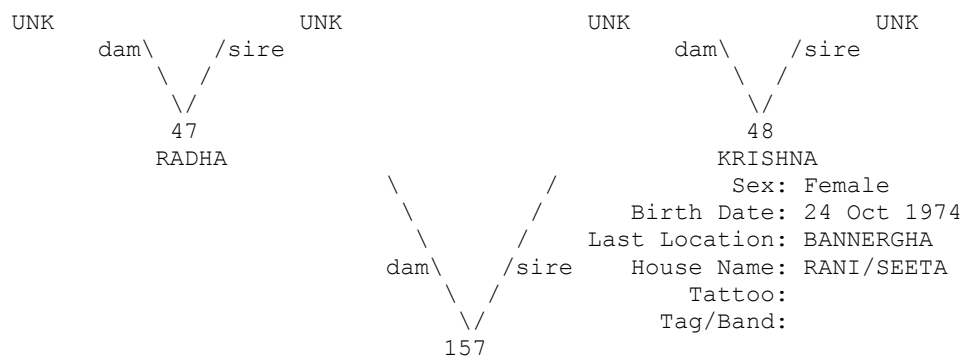

=====
 Taxon Name: PANTHERA TIGRIS Studbook Number: 158
 =====

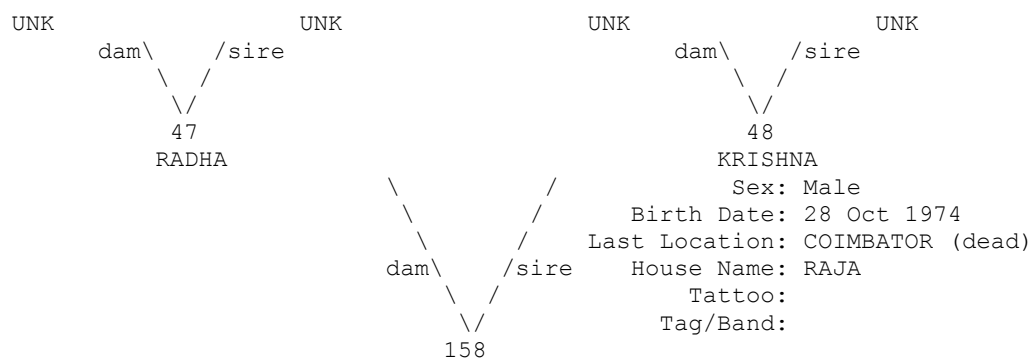

=====
 Taxon Name: PANTHERA TIGRIS Studbook Number: 164
 =====

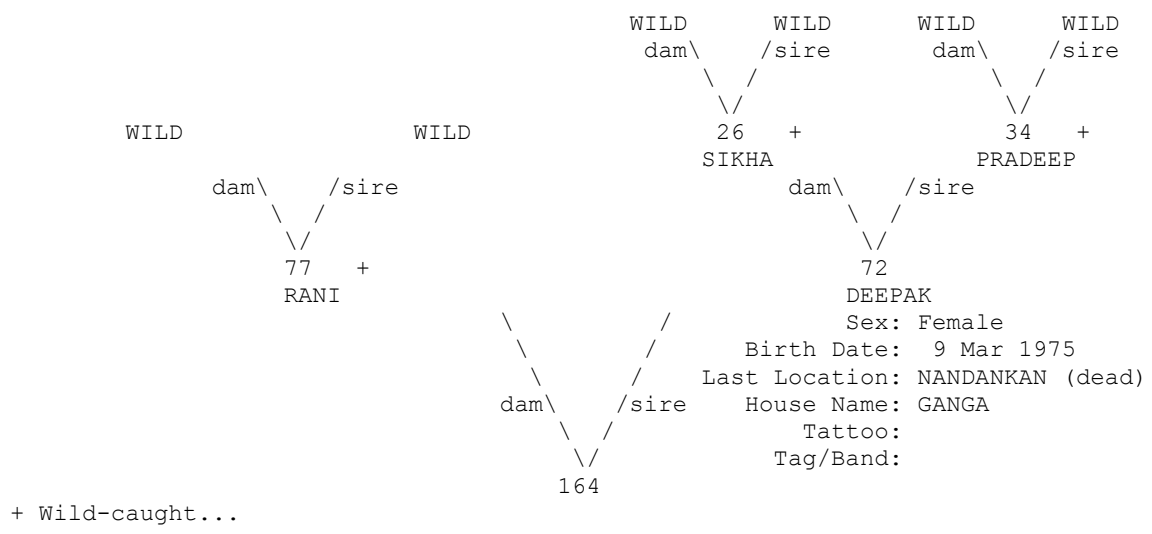

=====
 Taxon Name: PANTHERA TIGRIS Studbook Number: 165
 =====

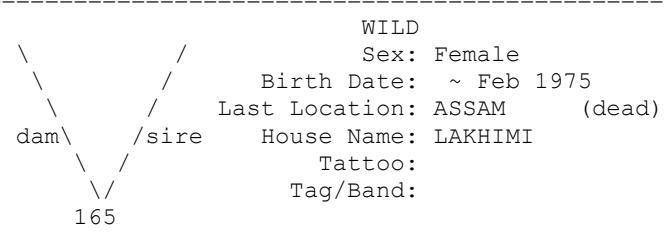

=====
 Taxon Name: PANTHERA TIGRIS Studbook Number: 166
 =====

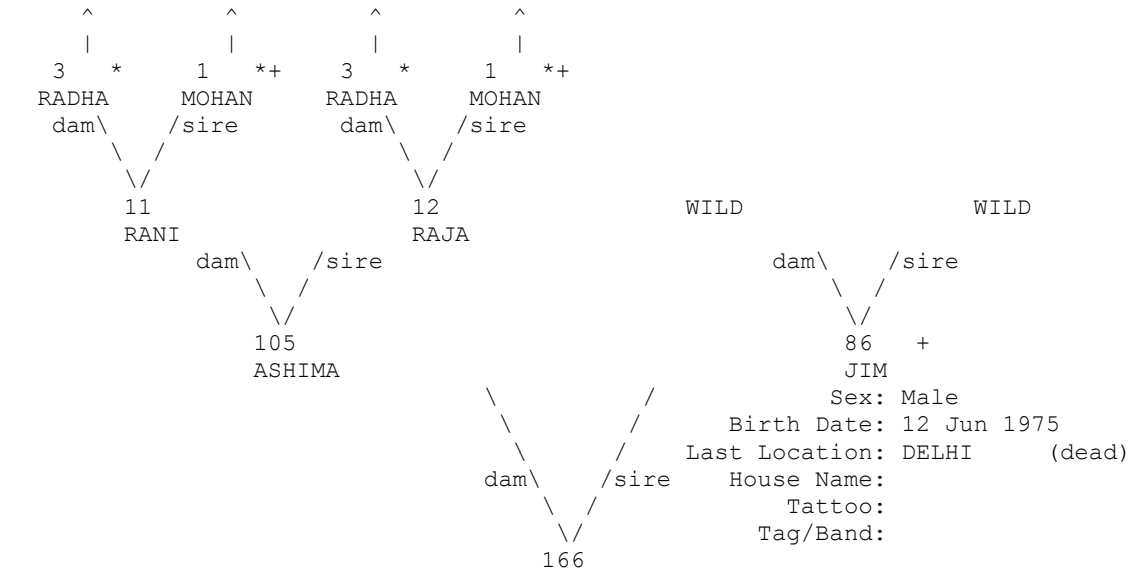

+ Wild-caught... * Appear more than once...
 ^ Pedigree continues beyond top of page...

=====
Taxon Name: PANTHERA TIGRIS Studbook Number: 169
=====

```
UNK dam\ /sire UNK UNK dam\ /sire UNK
      \  /      \  /
       47         48
      RADHA      KRISHNA
                Sex: Female
                Birth Date: 20 Oct 1975
                Last Location: AHMEDABAD (dead)
                House Name: JAMBAVI
                Tattoo:
                Tag/Band:

      \  /
       169
```

=====
Taxon Name: PANTHERA TIGRIS Studbook Number: 170
=====

```
UNK dam\ /sire UNK UNK dam\ /sire UNK
      \  /      \  /
       47         48
      RADHA      KRISHNA
                Sex: Female
                Birth Date: 21 Oct 1975
                Last Location: MYSORE (dead)
                House Name: SATYABHAMA
                Tattoo:
                Tag/Band:

      \  /
       170
```

=====
Taxon Name: PANTHERA TIGRIS Studbook Number: 171
=====

```
WILD WILD
      \  /      \  /
       171
      WILD
                Sex: Male
                Birth Date: ????
                Last Location: BHILAI (dead)
                House Name: SHANKAR
                Tattoo:
                Tag/Band:
```

=====
Taxon Name: PANTHERA TIGRIS Studbook Number: 172
=====

```
WILD WILD
      \  /      \  /
       172
      WILD
                Sex: Female
                Birth Date: ~ 1975
                Last Location: CIRCUS
                House Name: PAVOI
                Tattoo:
                Tag/Band:
```

=====
 Taxon Name: PANTHERA TIGRIS Studbook Number: 173
 =====

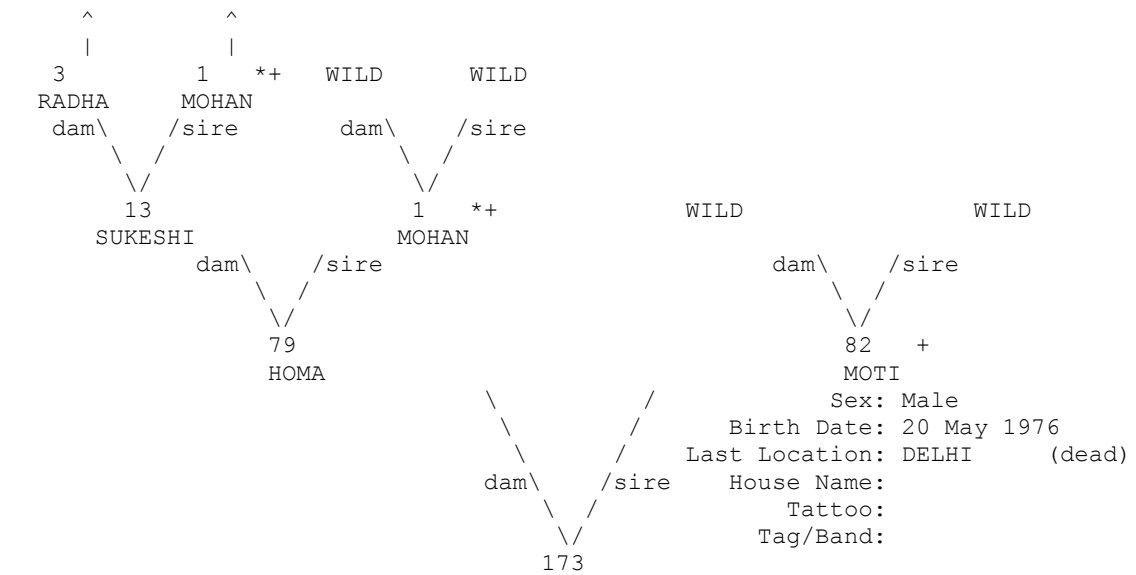

+ Wild-caught... * Appear more than once...
 ^ Pedigree continues beyond top of page...

=====
 Taxon Name: PANTHERA TIGRIS Studbook Number: 174
 =====

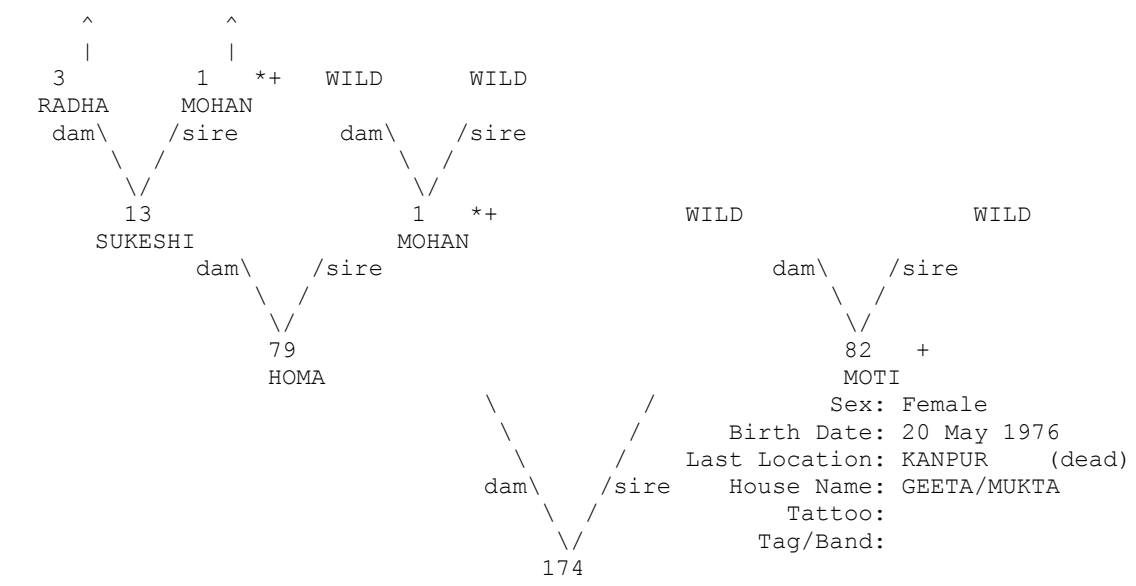

+ Wild-caught... * Appear more than once...
 ^ Pedigree continues beyond top of page...

=====
 Taxon Name: PANTHERA TIGRIS Studbook Number: 177
 =====

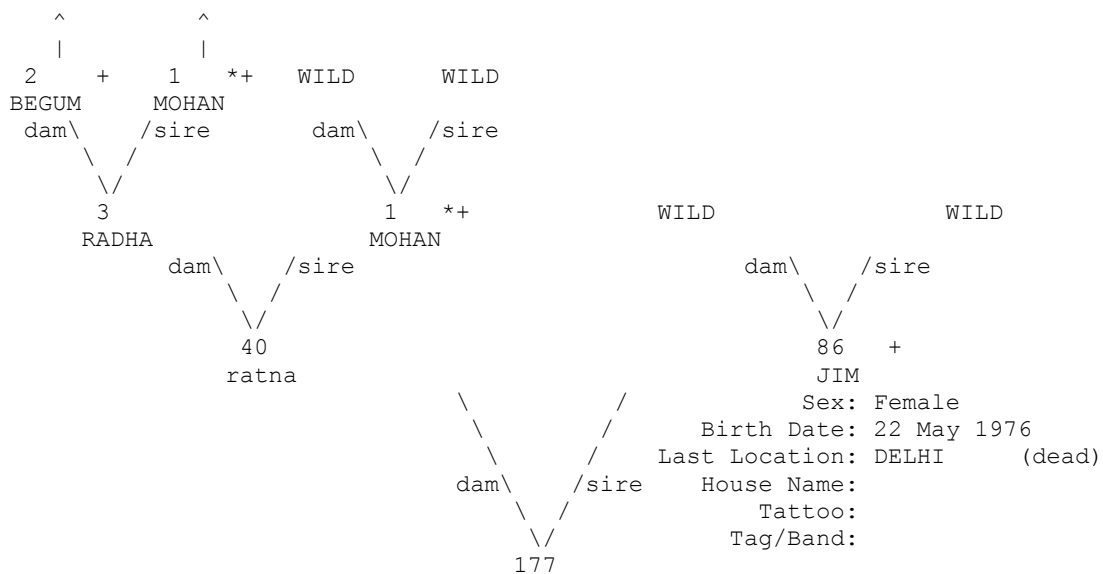

+ Wild-caught... * Appear more than once...
 ^ Pedigree continues beyond top of page...

=====
 Taxon Name: PANTHERA TIGRIS Studbook Number: 178
 =====

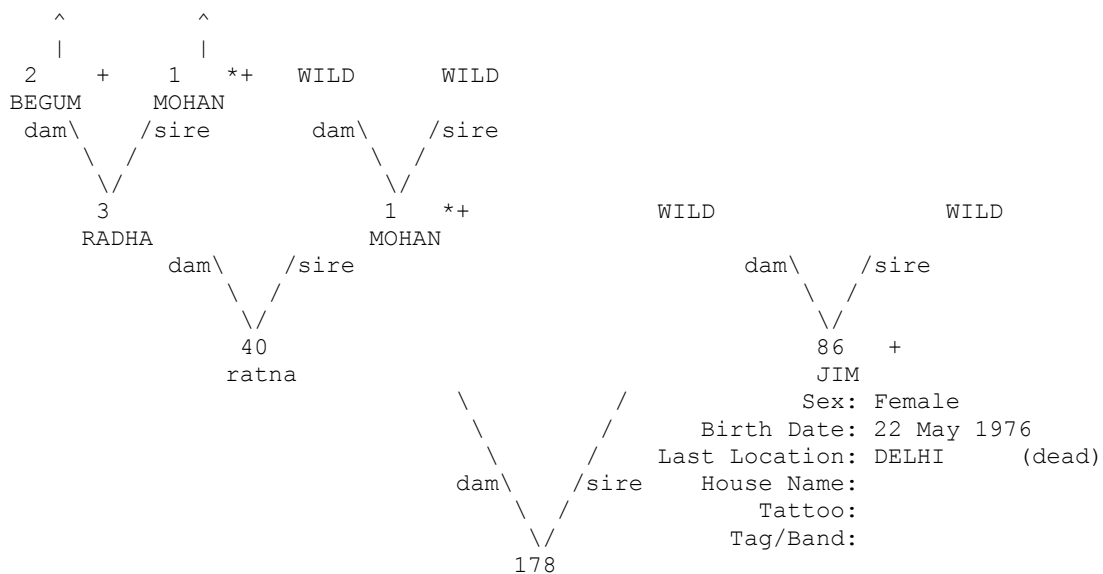

+ Wild-caught... * Appear more than once...
 ^ Pedigree continues beyond top of page...

=====
 Taxon Name: PANTHERA TIGRIS Studbook Number: 179
 =====

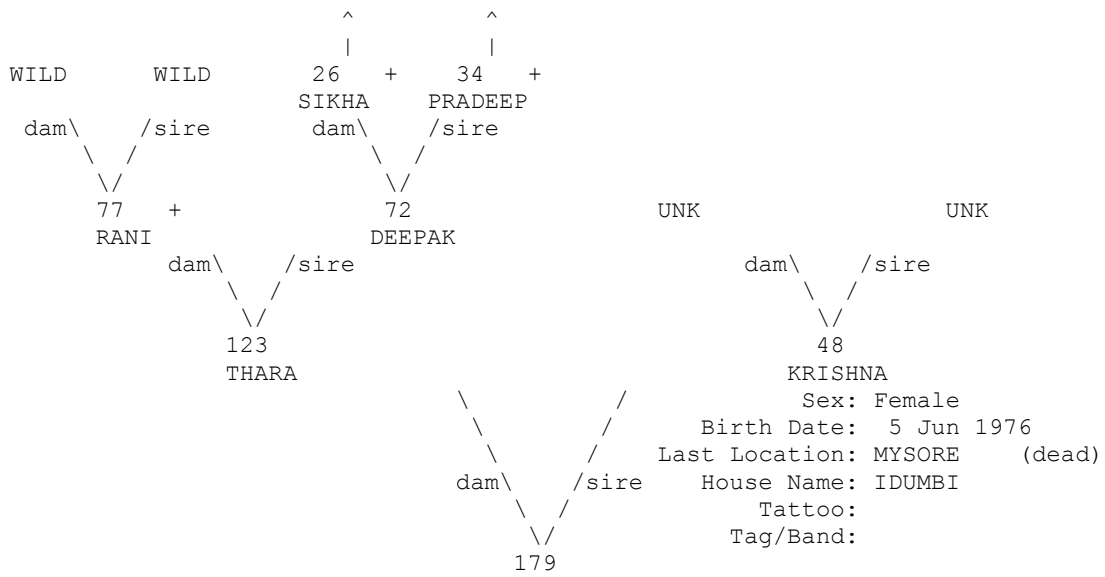

+ Wild-caught...
 ^ Pedigree continues beyond top of page...

=====
 Taxon Name: PANTHERA TIGRIS Studbook Number: 180
 =====

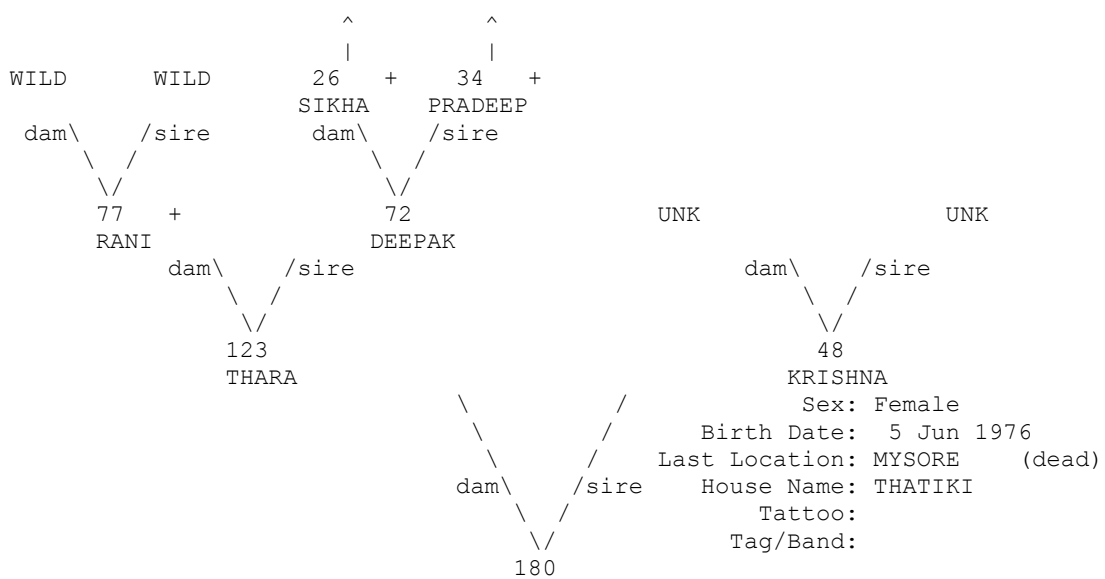

+ Wild-caught...
 ^ Pedigree continues beyond top of page...

=====
 Taxon Name: PANTHERA TIGRIS Studbook Number: 181
 =====

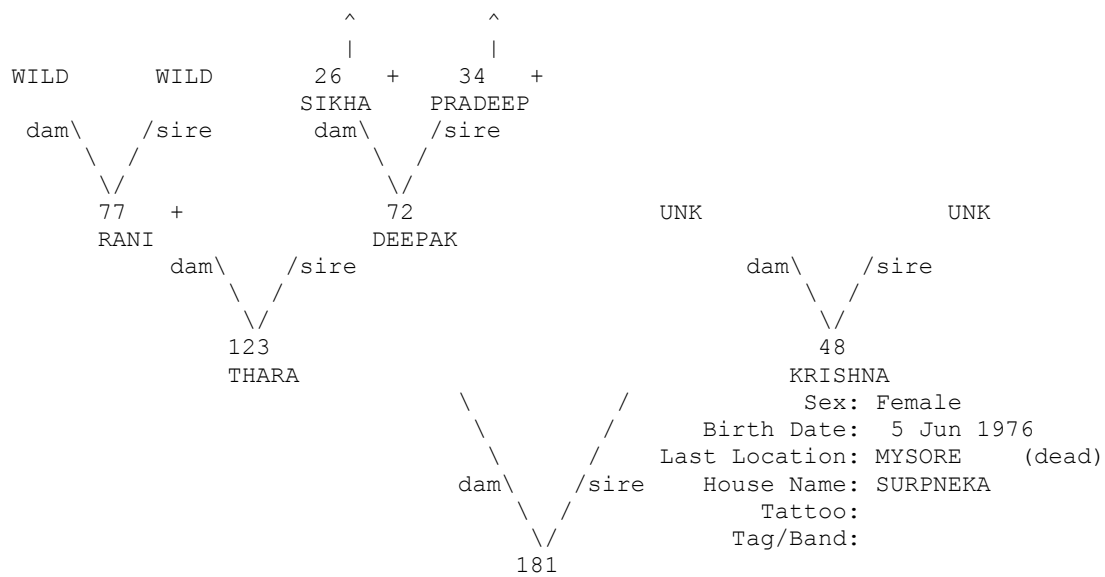

+ Wild-caught...
 ^ Pedigree continues beyond top of page...

=====
 Taxon Name: PANTHERA TIGRIS Studbook Number: 182
 =====

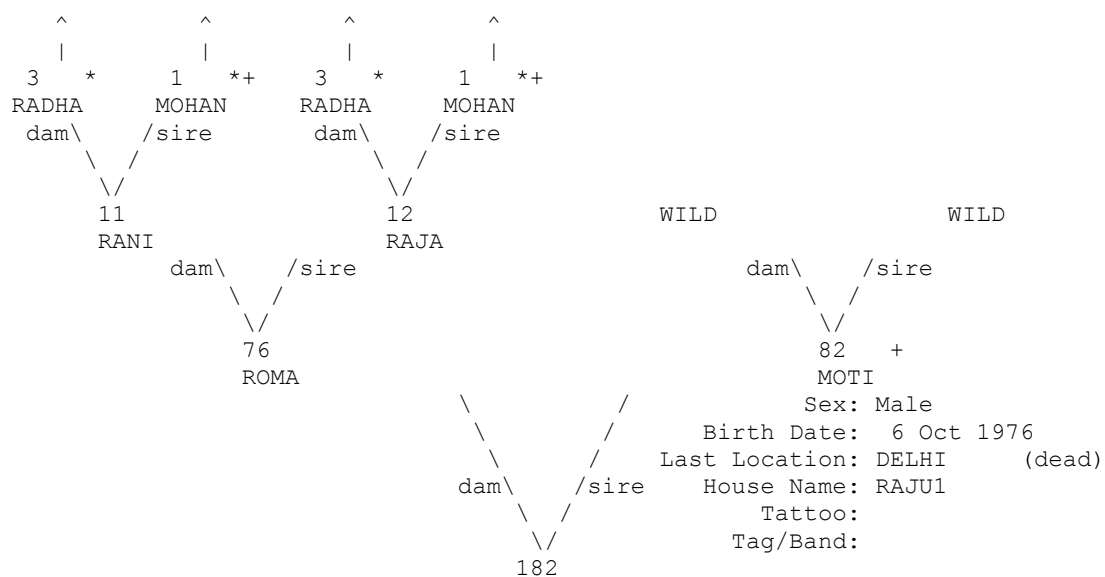

+ Wild-caught... * Appear more than once...
 ^ Pedigree continues beyond top of page...

=====
 Taxon Name: PANTHERA TIGRIS Studbook Number: 183
 =====

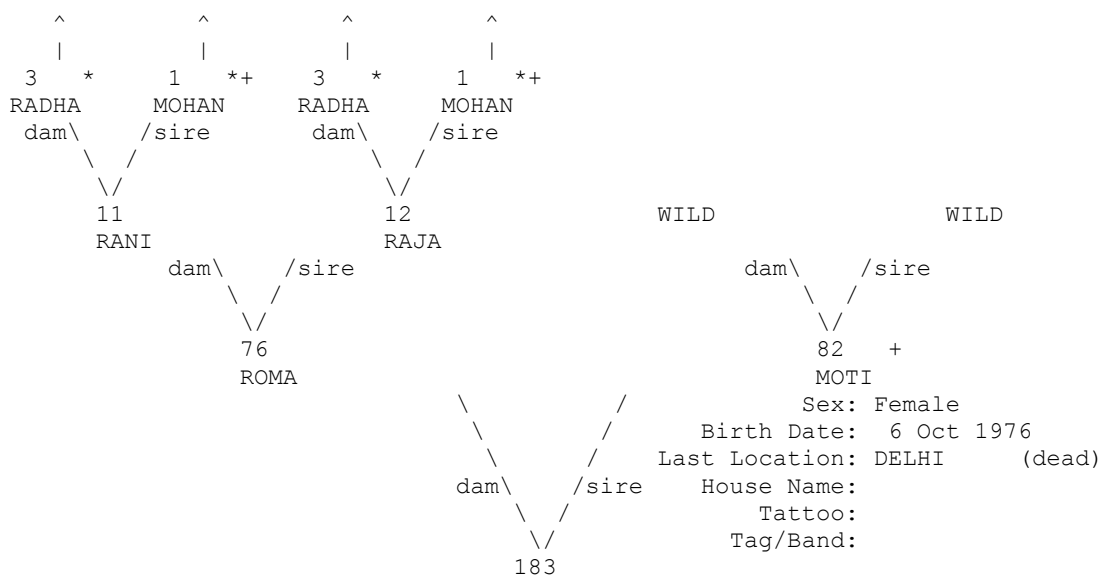

+ Wild-caught... * Appear more than once...
 ^ Pedigree continues beyond top of page...

=====
 Taxon Name: PANTHERA TIGRIS Studbook Number: 184
 =====

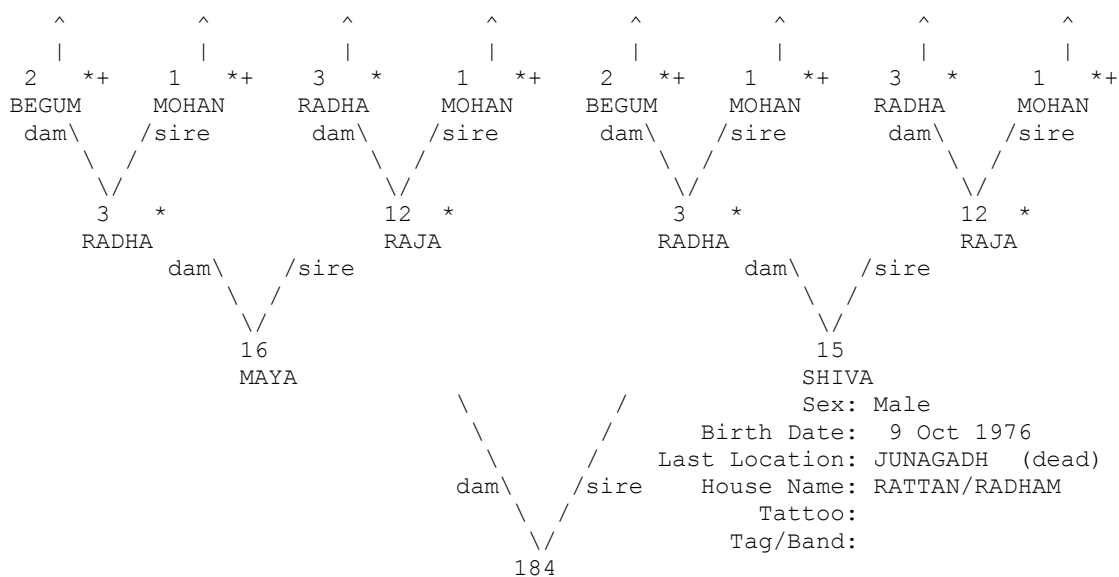

+ Wild-caught... * Appear more than once...
 ^ Pedigree continues beyond top of page...

=====
 Taxon Name: PANTHERA TIGRIS Studbook Number: 185
 =====

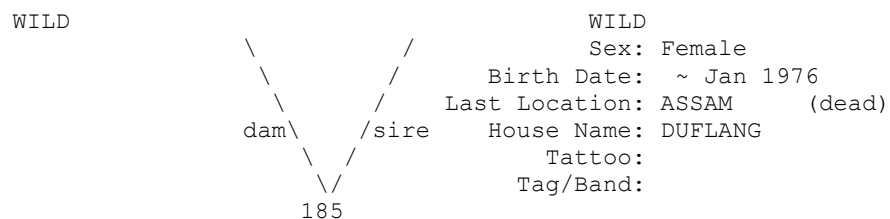

=====
 Taxon Name: PANTHERA TIGRIS Studbook Number: 186
 =====

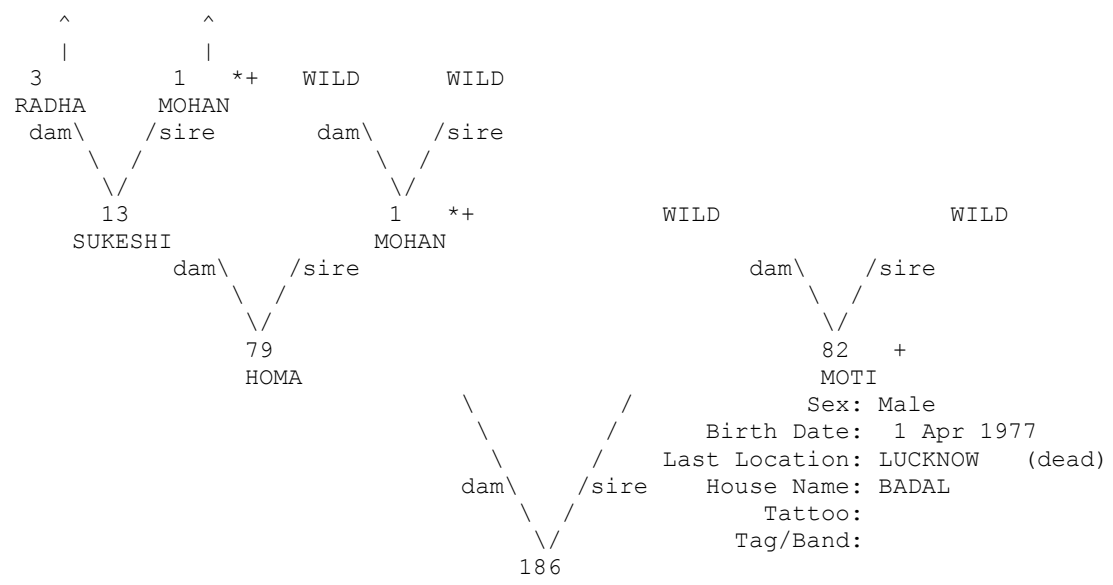

+ Wild-caught... * Appear more than once...
 ^ Pedigree continues beyond top of page...

=====
 Taxon Name: PANTHERA TIGRIS Studbook Number: 187
 =====

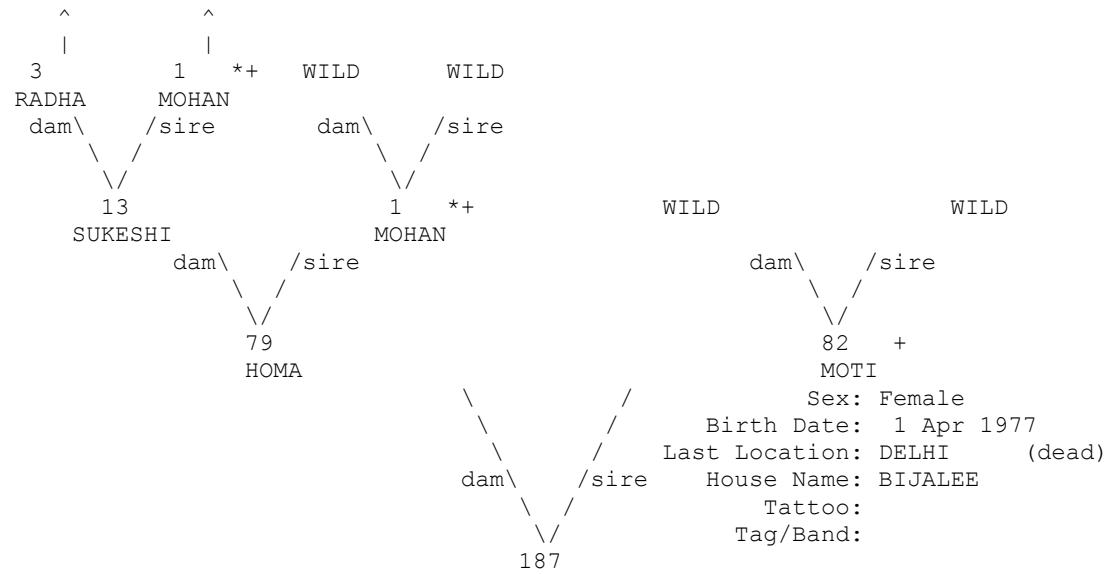

+ Wild-caught... * Appear more than once...
 ^ Pedigree continues beyond top of page...

=====
 Taxon Name: PANTHERA TIGRIS Studbook Number: 190
 =====

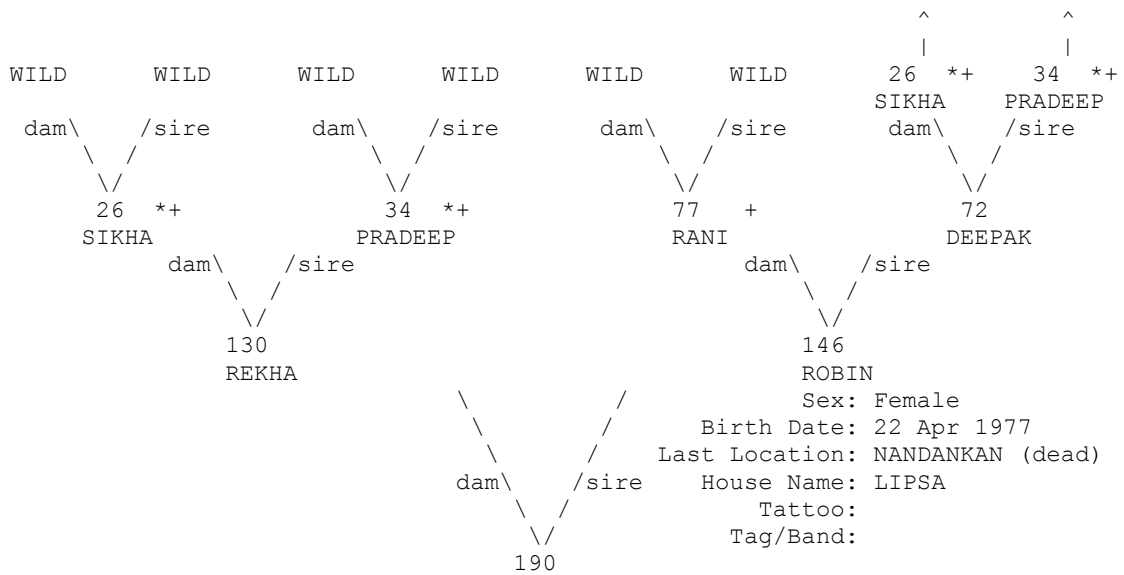

+ Wild-caught... * Appear more than once...
 ^ Pedigree continues beyond top of page...

=====
 Taxon Name: PANTHERA TIGRIS Studbook Number: 191
 =====

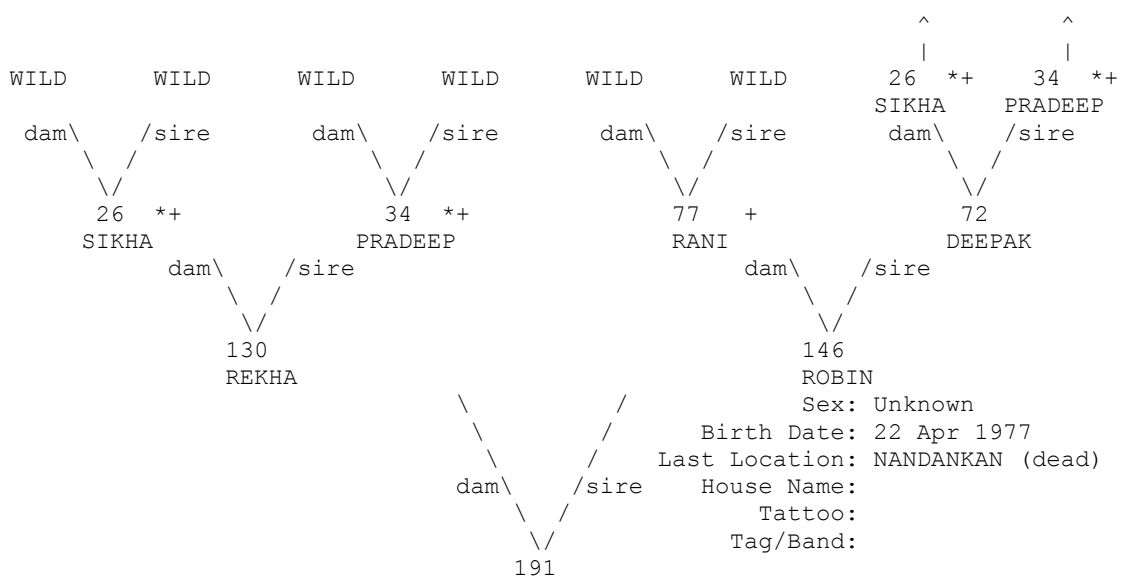

+ Wild-caught... * Appear more than once...
 ^ Pedigree continues beyond top of page...

=====
 Taxon Name: PANTHERA TIGRIS Studbook Number: 192
 =====

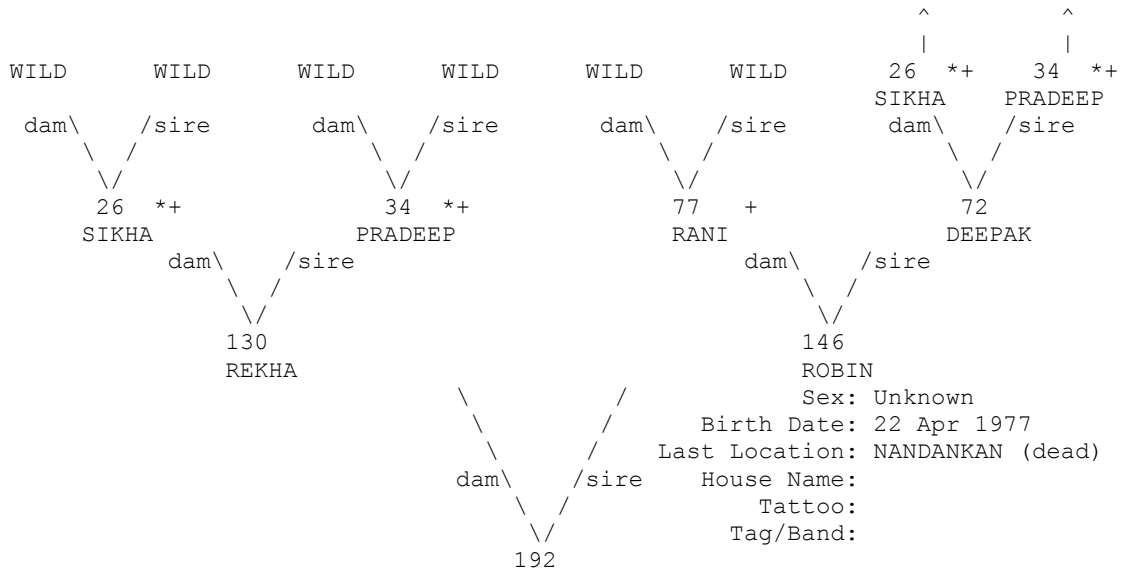

+ Wild-caught... * Appear more than once...
 ^ Pedigree continues beyond top of page...

=====
 Taxon Name: PANTHERA TIGRIS Studbook Number: 193
 =====

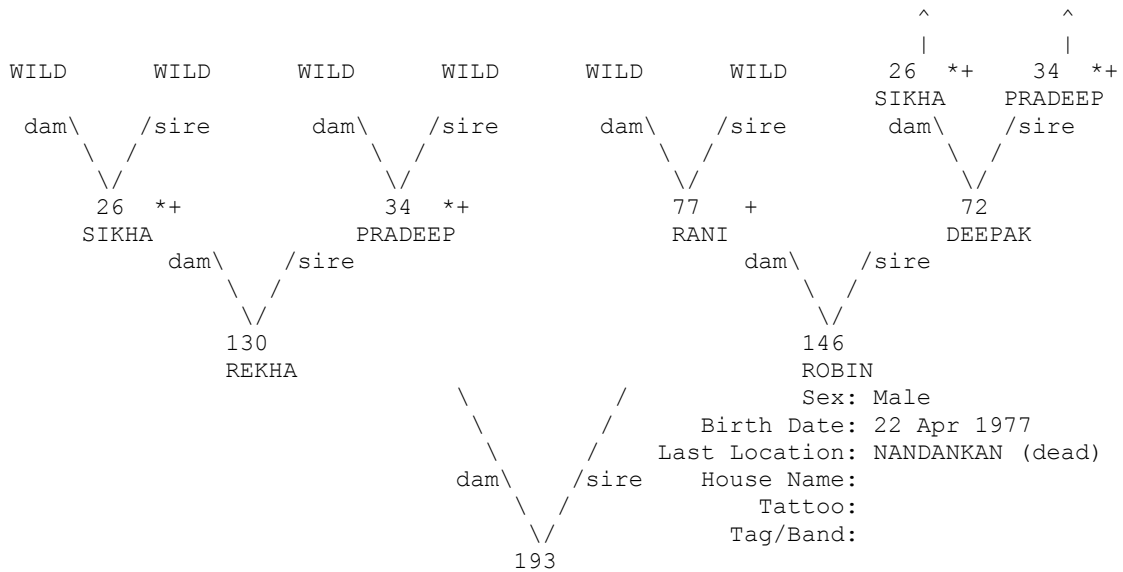

+ Wild-caught... * Appear more than once...
 ^ Pedigree continues beyond top of page...

=====
 Taxon Name: PANTHERA TIGRIS Studbook Number: 194
 =====

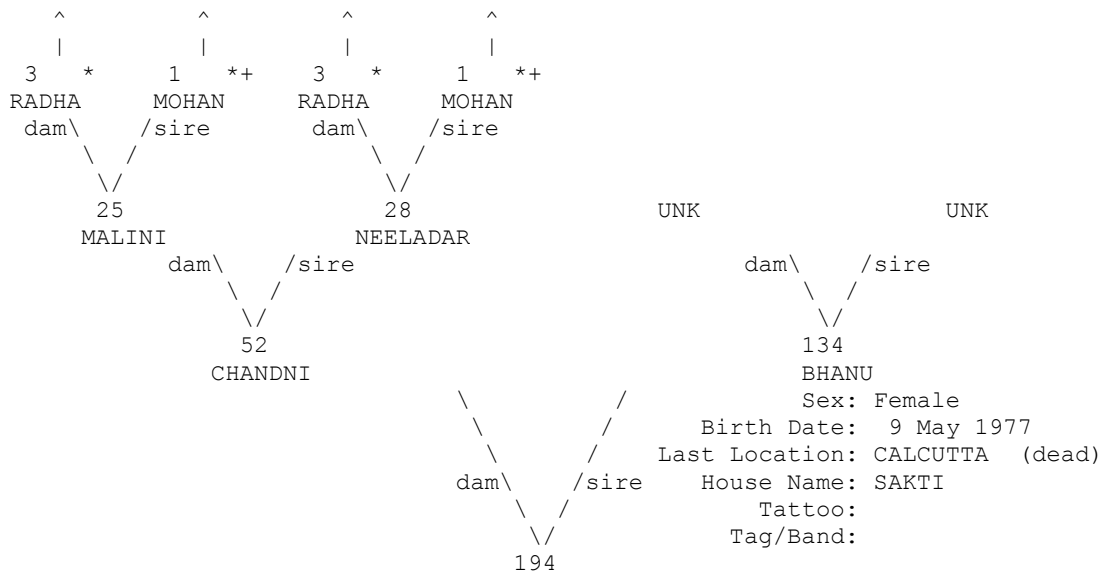

+ Wild-caught... * Appear more than once...
 ^ Pedigree continues beyond top of page...

=====
 Taxon Name: PANTHERA TIGRIS Studbook Number: 195
 =====

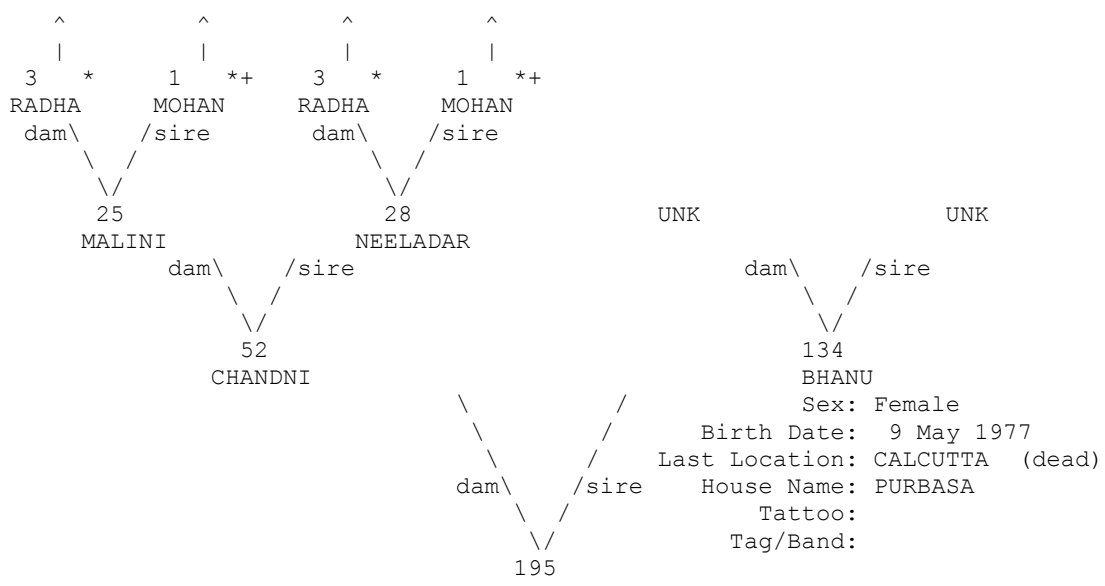

+ Wild-caught... * Appear more than once...
 ^ Pedigree continues beyond top of page...

=====
 Taxon Name: PANTHERA TIGRIS Studbook Number: 198
 =====

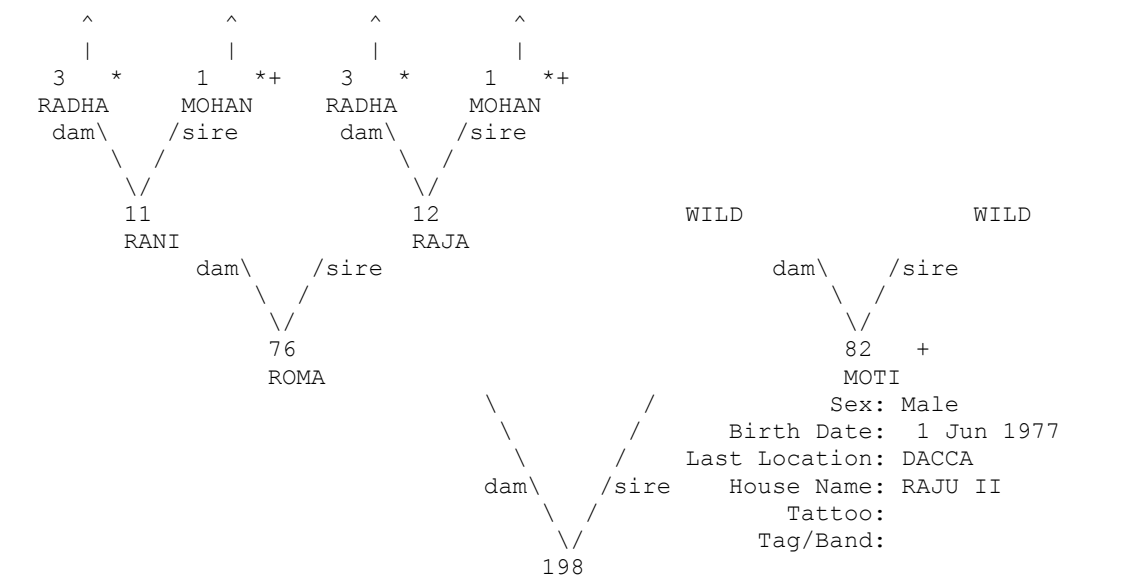

+ Wild-caught... * Appear more than once...
 ^ Pedigree continues beyond top of page...

=====
 Taxon Name: PANTHERA TIGRIS Studbook Number: 199
 =====

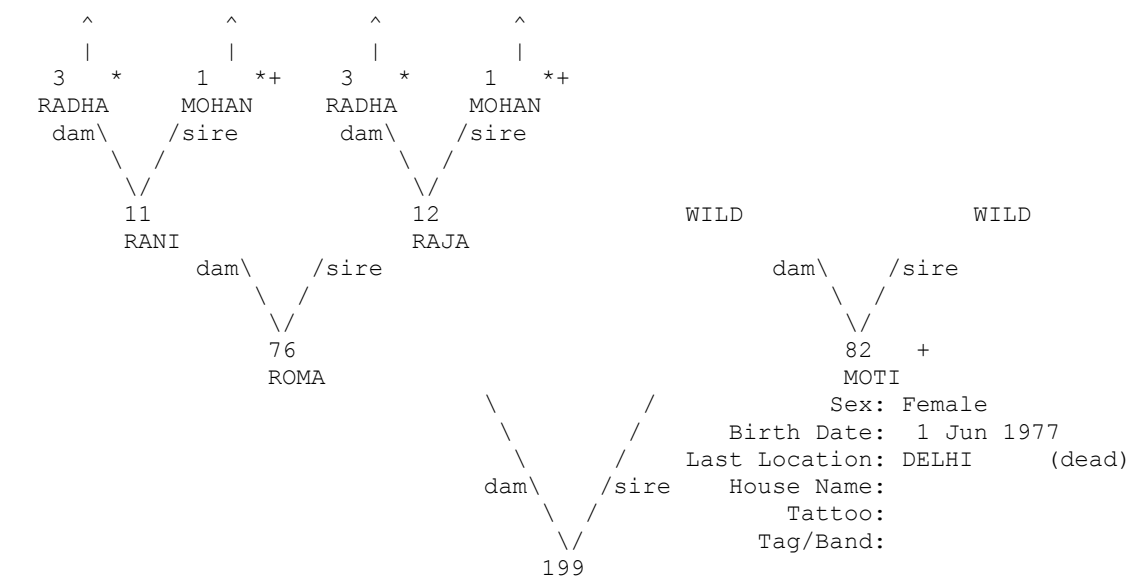

+ Wild-caught... * Appear more than once...
 ^ Pedigree continues beyond top of page...

=====
 Taxon Name: PANTHERA TIGRIS Studbook Number: 200
 =====

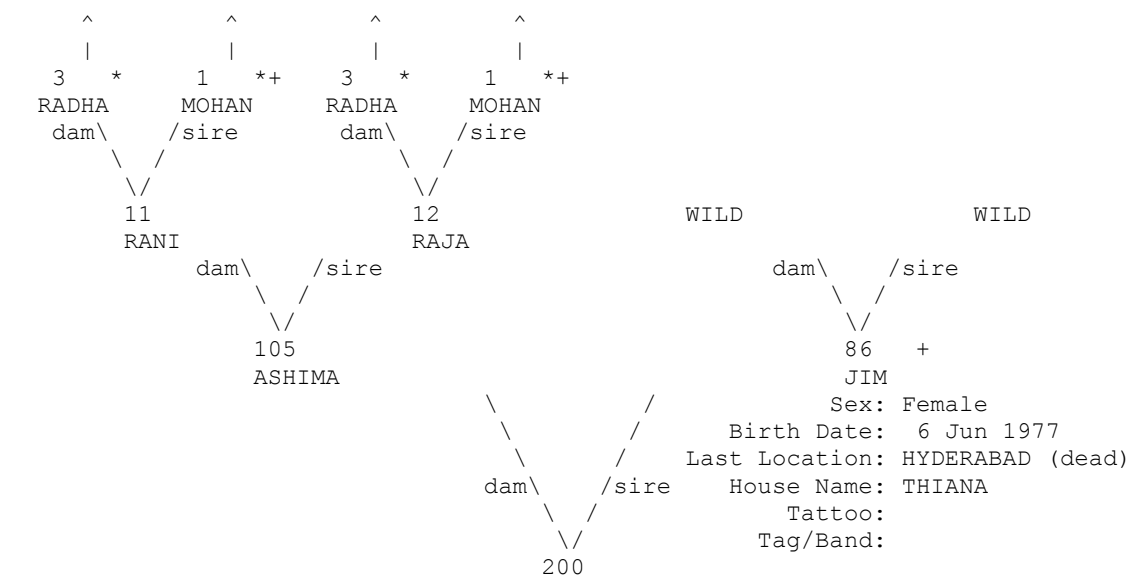

+ Wild-caught... * Appear more than once...
 ^ Pedigree continues beyond top of page...

=====
 Taxon Name: PANTHERA TIGRIS Studbook Number: 201
 =====

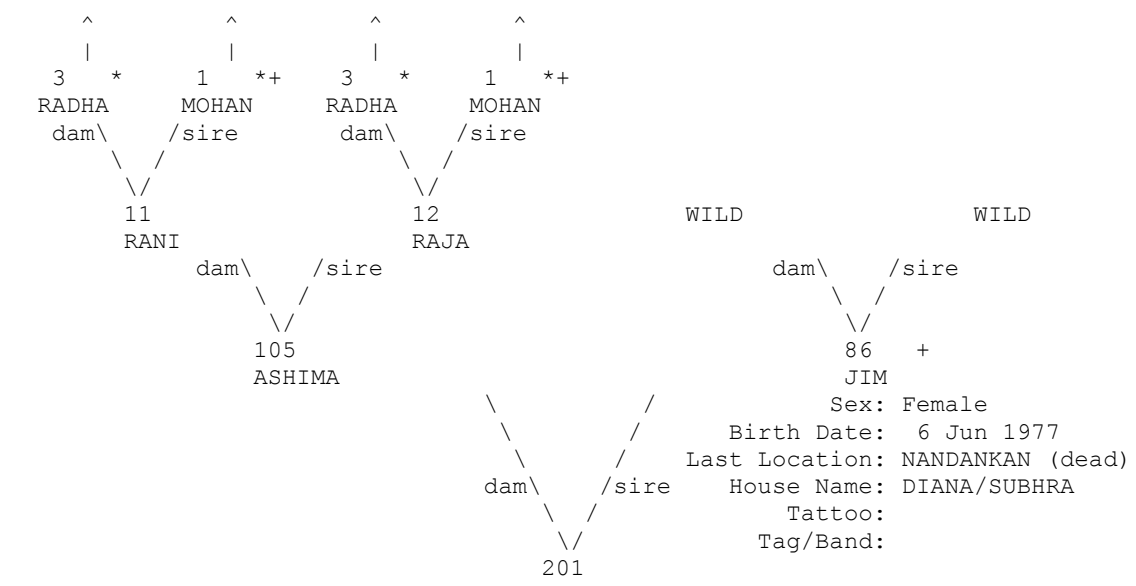

+ Wild-caught... * Appear more than once...
 ^ Pedigree continues beyond top of page...

=====
 Taxon Name: PANTHERA TIGRIS Studbook Number: 202
 =====

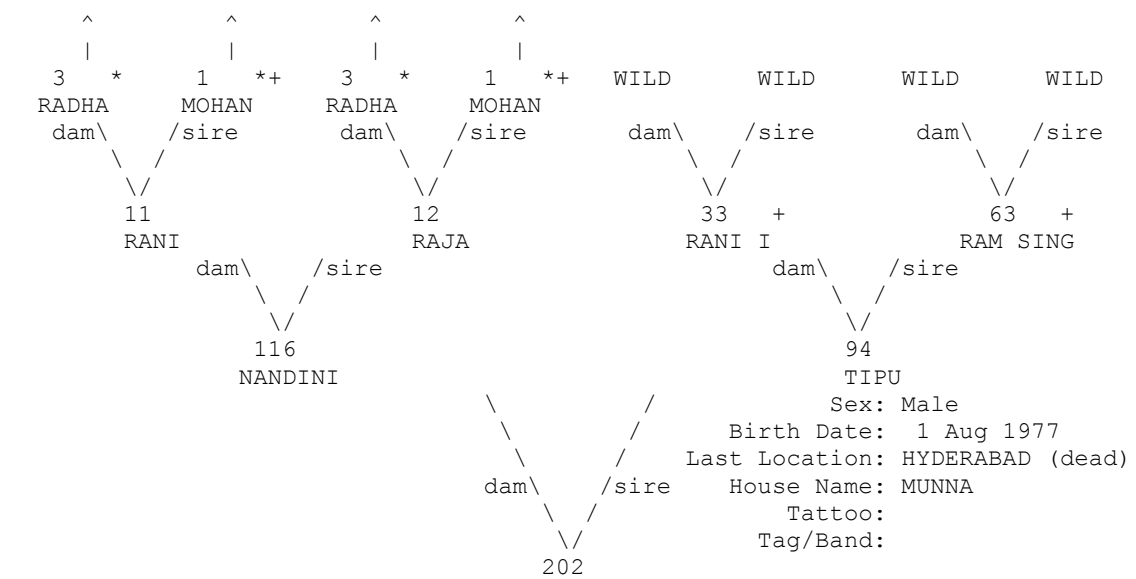

+ Wild-caught... * Appear more than once...
 ^ Pedigree continues beyond top of page...

=====
 Taxon Name: PANTHERA TIGRIS Studbook Number: 203
 =====

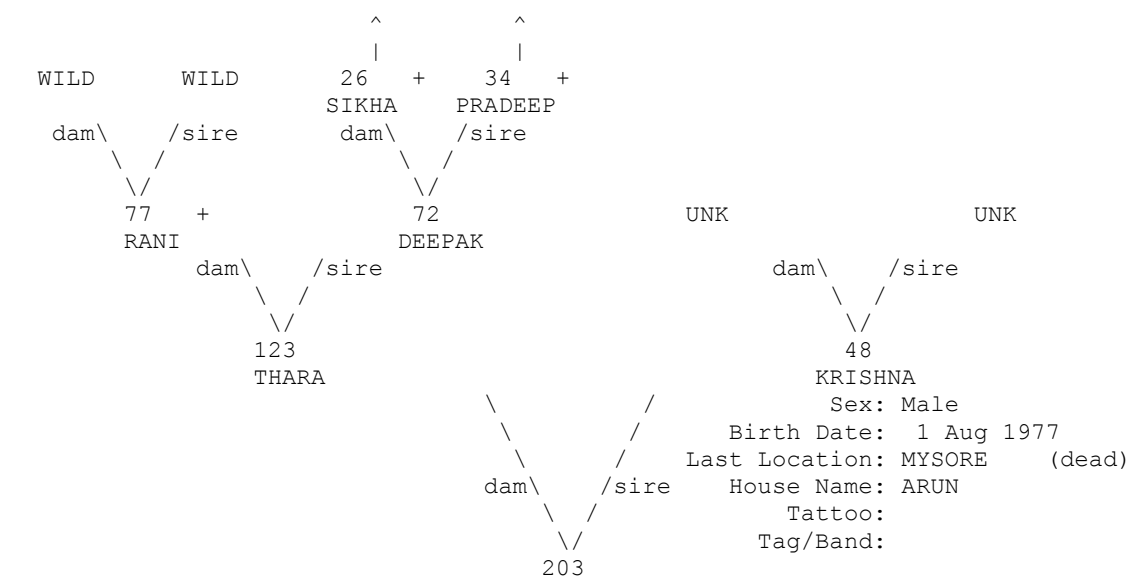

+ Wild-caught...
 ^ Pedigree continues beyond top of page...

=====
 Taxon Name: PANTHERA TIGRIS Studbook Number: 204
 =====

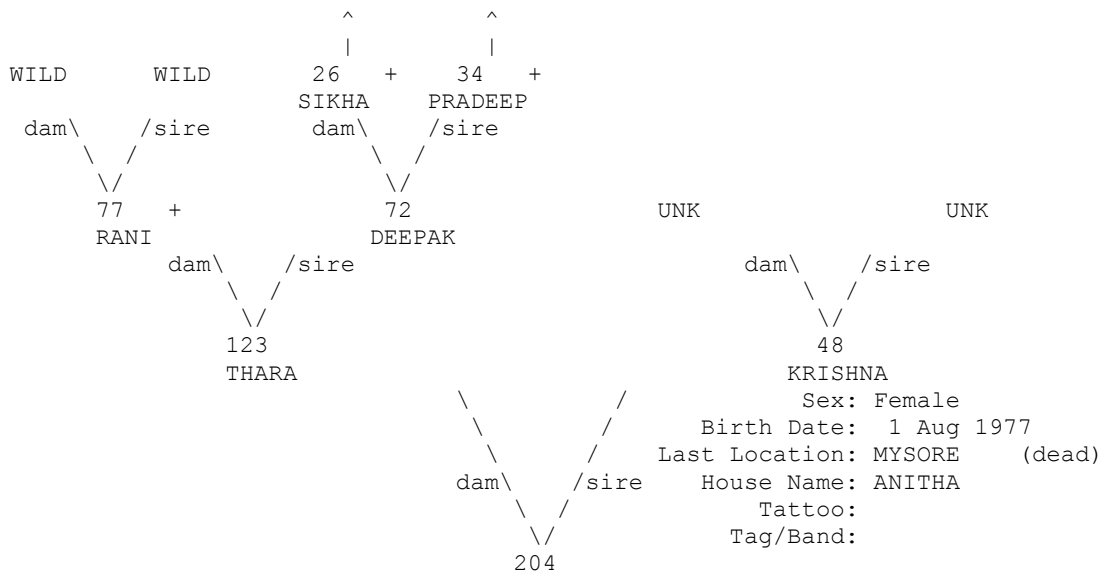

+ Wild-caught...
 ^ Pedigree continues beyond top of page...

=====
 Taxon Name: PANTHERA TIGRIS Studbook Number: 205
 =====

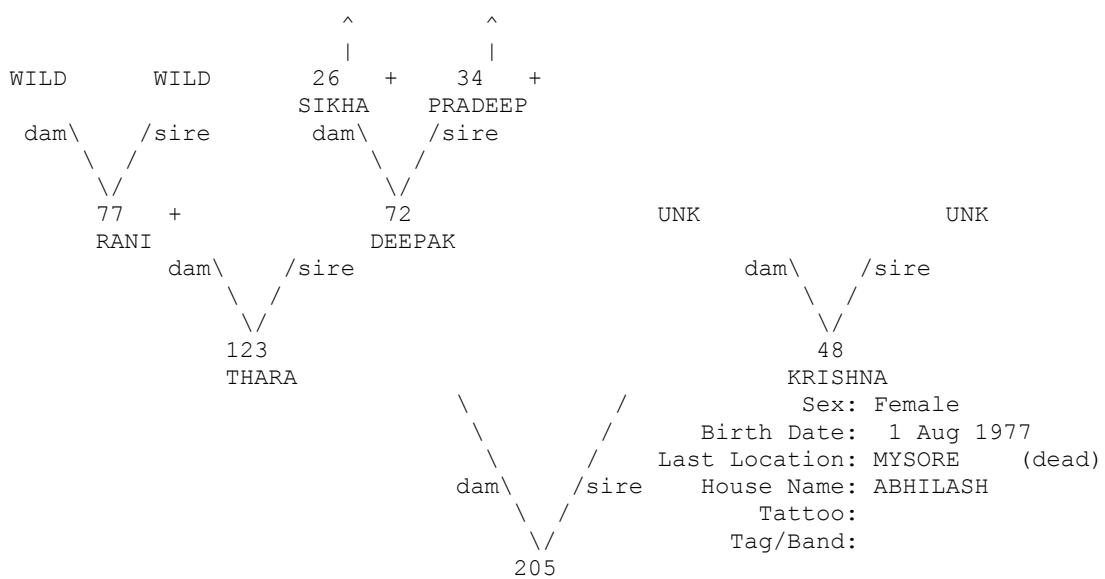

+ Wild-caught...
 ^ Pedigree continues beyond top of page...

=====
 Taxon Name: PANTHERA TIGRIS Studbook Number: 206
 =====

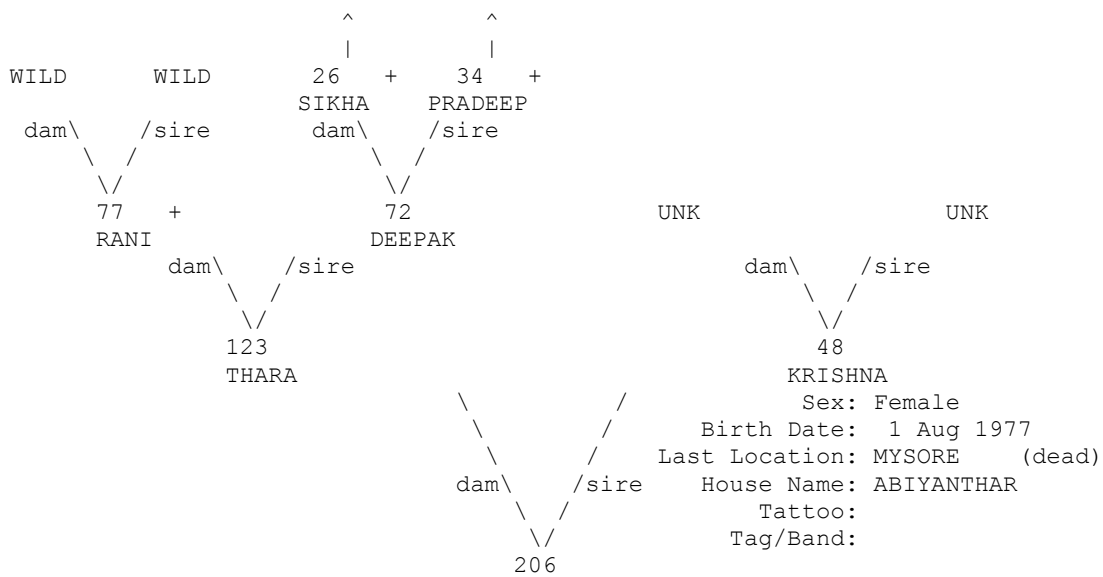

+ Wild-caught...
 ^ Pedigree continues beyond top of page...

=====
 Taxon Name: PANTHERA TIGRIS Studbook Number: 207
 =====

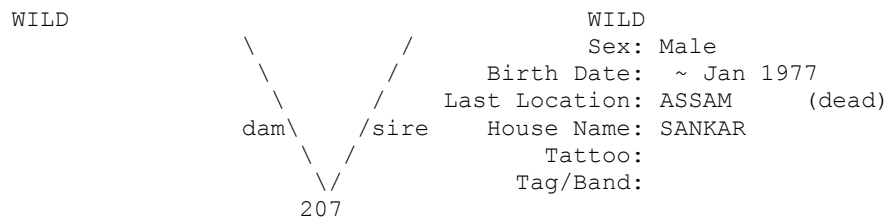

=====
 Taxon Name: PANTHERA TIGRIS Studbook Number: 208
 =====

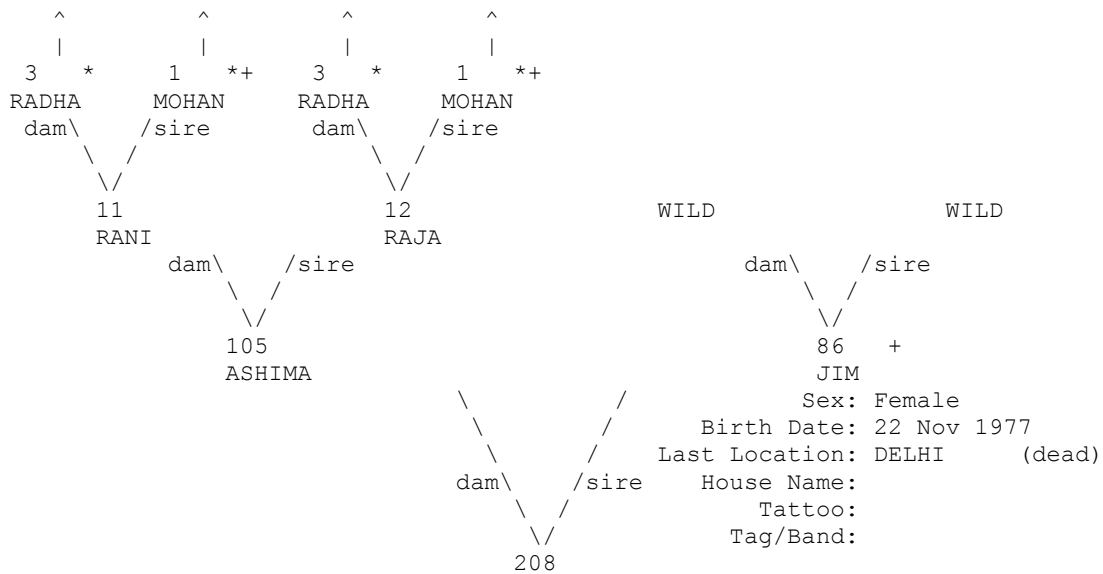

+ Wild-caught... * Appear more than once...
 ^ Pedigree continues beyond top of page...

=====
 Taxon Name: PANTHERA TIGRIS Studbook Number: 209
 =====

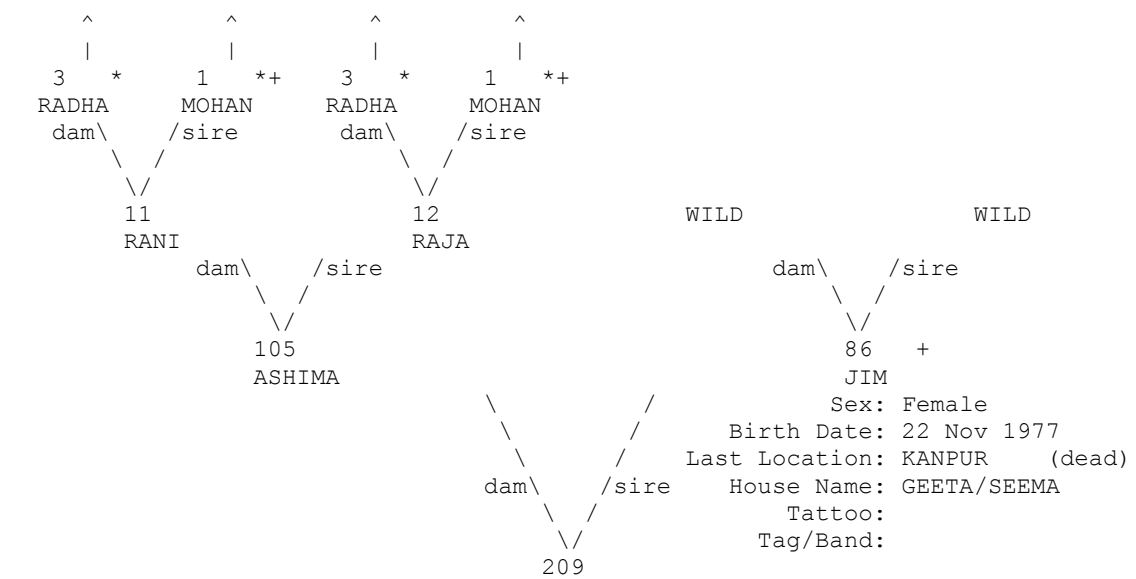

+ Wild-caught... * Appear more than once...
 ^ Pedigree continues beyond top of page...

=====
 Taxon Name: PANTHERA TIGRIS Studbook Number: 210
 =====

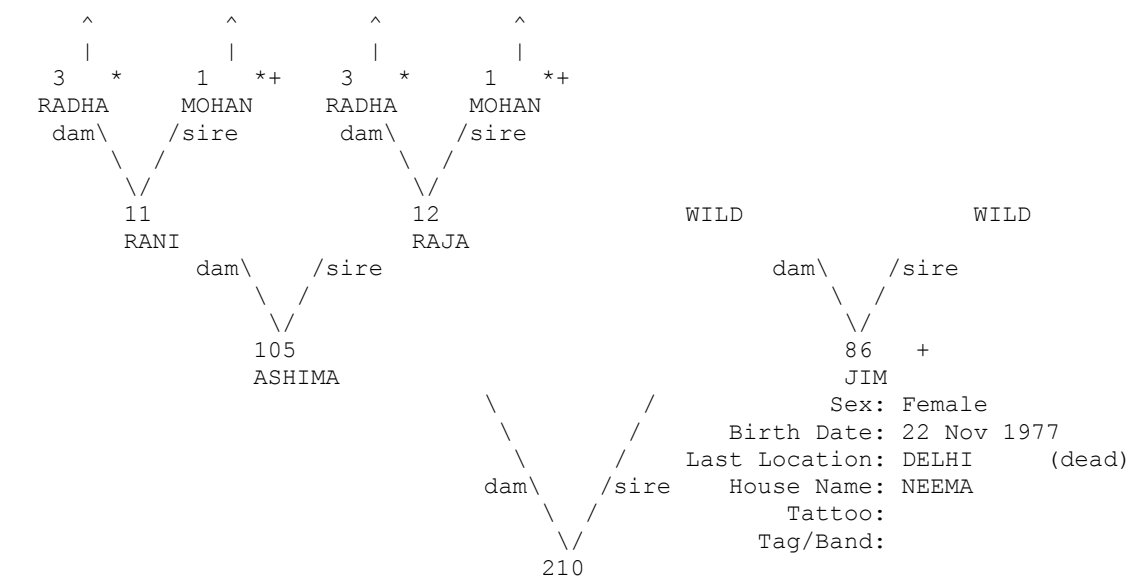

+ Wild-caught... * Appear more than once...
 ^ Pedigree continues beyond top of page...

=====
 Taxon Name: PANTHERA TIGRIS Studbook Number: 211
 =====

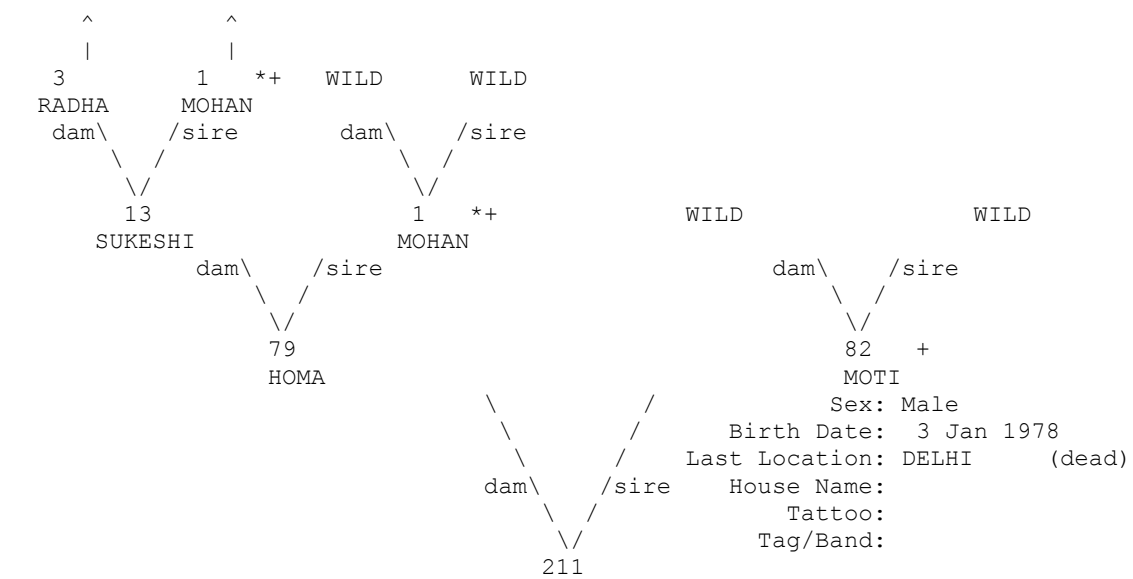

+ Wild-caught... * Appear more than once...
 ^ Pedigree continues beyond top of page...

=====
 Taxon Name: PANTHERA TIGRIS Studbook Number: 212
 =====

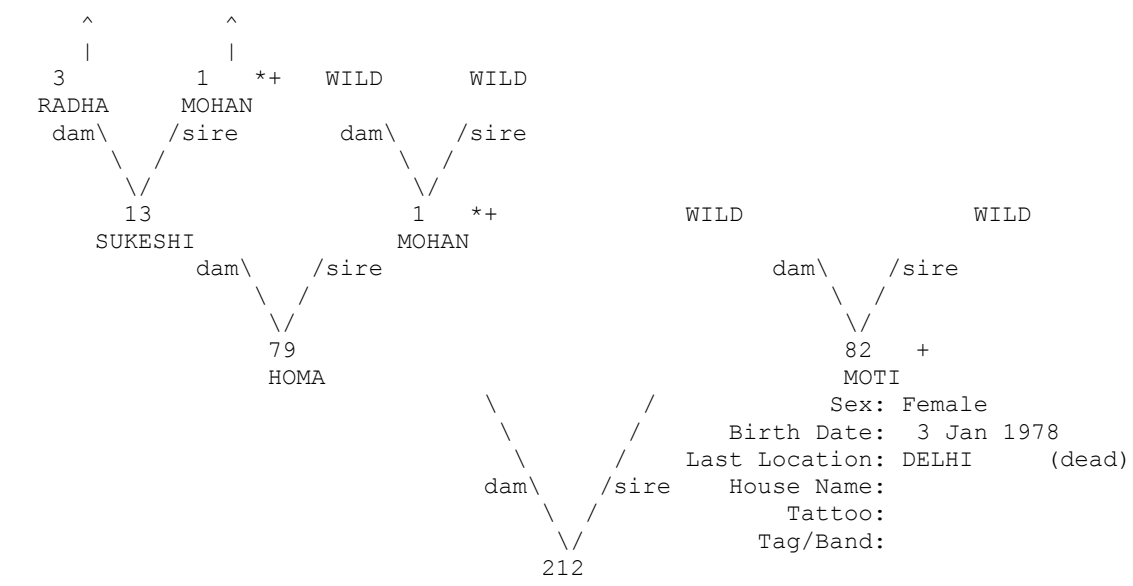

+ Wild-caught... * Appear more than once...
 ^ Pedigree continues beyond top of page...

=====
 Taxon Name: PANTHERA TIGRIS Studbook Number: 213
 =====

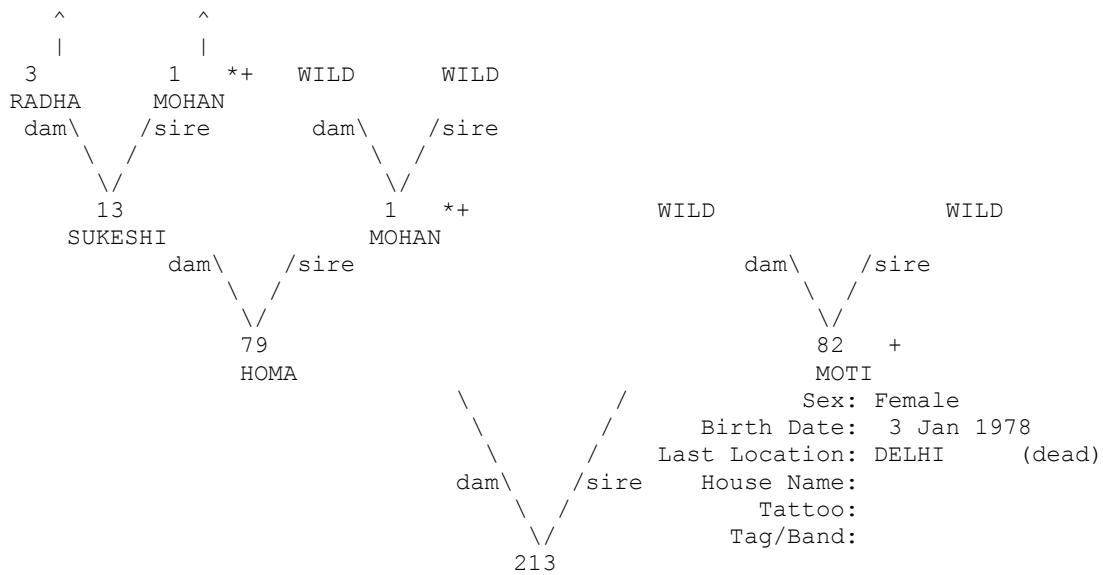

+ Wild-caught... * Appear more than once...
 ^ Pedigree continues beyond top of page...

=====
 Taxon Name: PANTHERA TIGRIS Studbook Number: 214
 =====

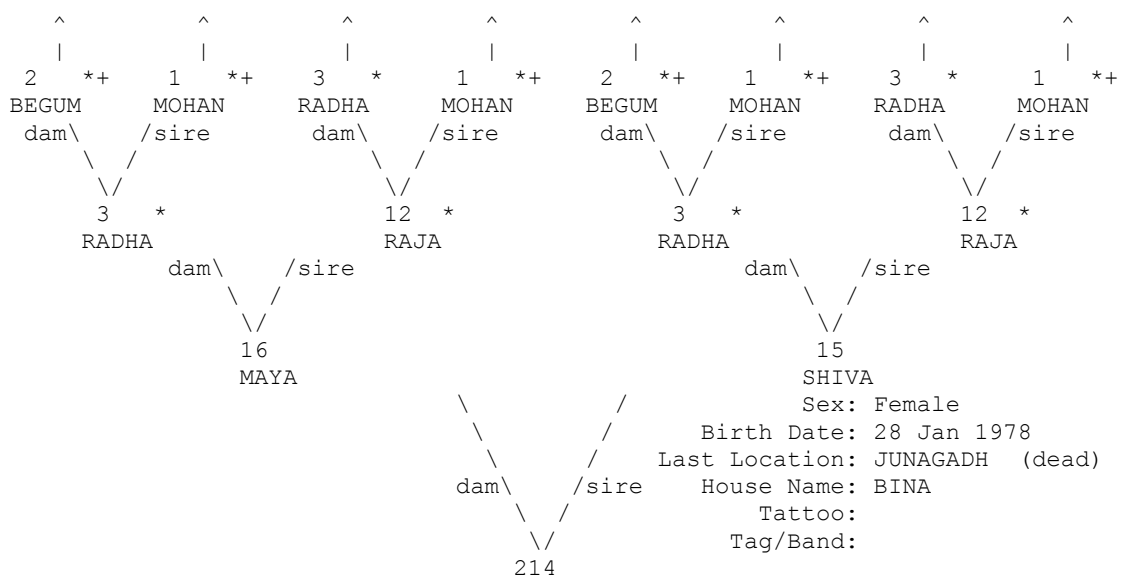

+ Wild-caught... * Appear more than once...
 ^ Pedigree continues beyond top of page...

=====
 Taxon Name: PANTHERA TIGRIS Studbook Number: 215
 =====

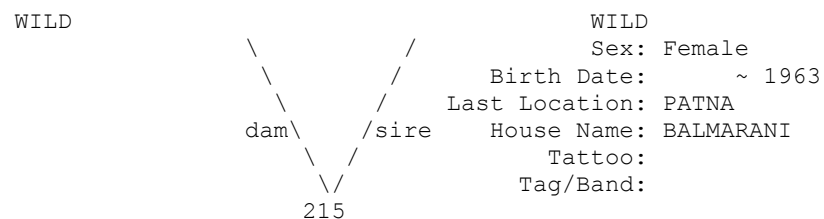

```

=====
Taxon Name: PANTHERA TIGRIS                      Studbook Number: 216
=====
WILD
dam \ / sire
  \ /
   V
  216
WILD
Sex: Female
Birth Date: ~ 1965
Last Location: ASSAM (dead)
House Name: CHATAIRANI
Tattoo:
Tag/Band:

```

```

=====
Taxon Name: PANTHERA TIGRIS                      Studbook Number: 217
=====
UNK dam \ / sire UNK UNK dam \ / sire UNK
  \ /         \ /         \ /         \ /
   V           V           V           V
  47          48
RADHA        KRISHNA
Sex: Male
Birth Date: 18 Mar 1978
Last Location: AHMEDABAD (dead)
House Name: VISHNU
Tattoo:
Tag/Band:
dam \ / sire
  \ /
   V
  217

```

```

=====
Taxon Name: PANTHERA TIGRIS                      Studbook Number: 218
=====
WILD WILD WILD WILD WILD WILD WILD WILD
dam \ / sire + dam \ / sire + dam \ / sire + dam \ / sire
  \ /         \ /         \ /         \ /
   V           V           V           V
  77          72          33          63
RANI         DEEPAK      RANI I      RAM SING
+           +           +           +
dam \ / sire + dam \ / sire
  \ /         \ /
   V           V
  145          94
ORIYA/OR      TIPU
Sex: Male
Birth Date: 16 Apr 1978
Last Location: JUNAGADH (dead)
House Name: RAMU
Tattoo:
Tag/Band:
dam \ / sire
  \ /
   V
  218

```

+ Wild-caught...
^ Pedigree continues beyond top of page...

=====
 Taxon Name: PANTHERA TIGRIS Studbook Number: 219
 =====

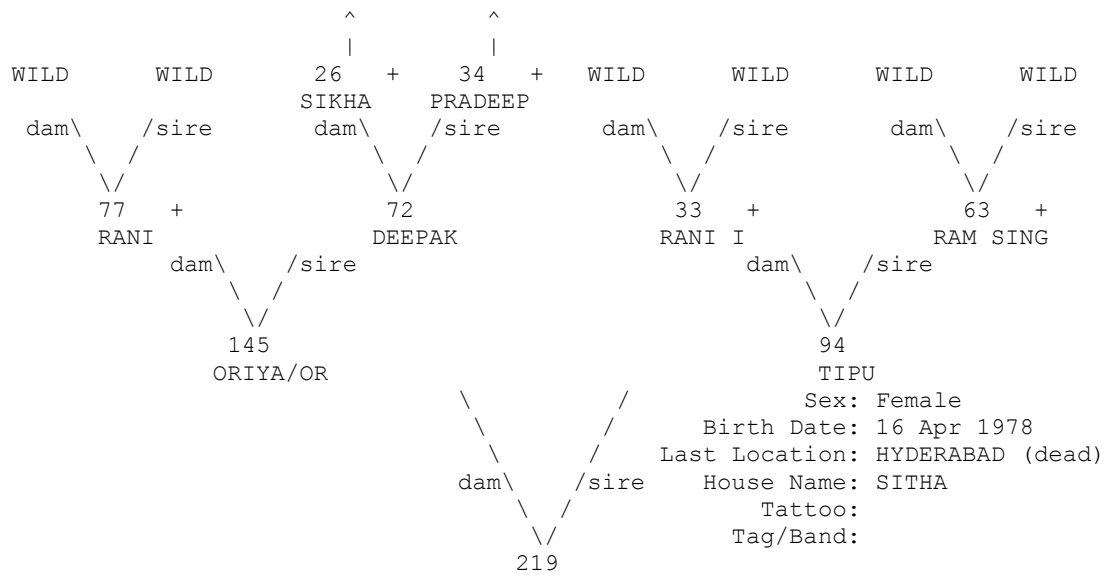

+ Wild-caught...
 ^ Pedigree continues beyond top of page...

=====
 Taxon Name: PANTHERA TIGRIS Studbook Number: 220
 =====

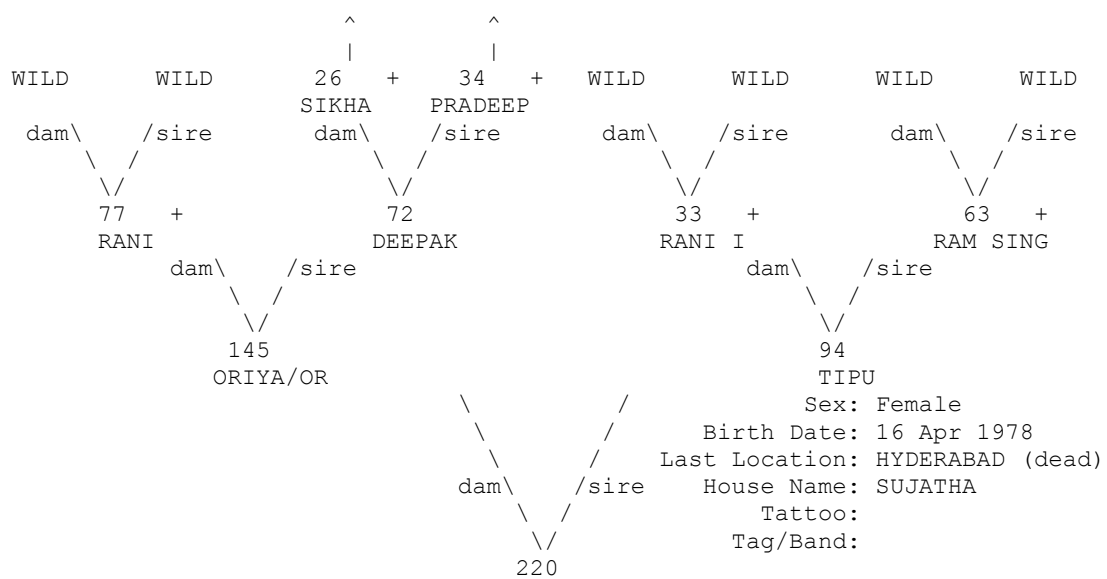

+ Wild-caught...
 ^ Pedigree continues beyond top of page...

=====
 Taxon Name: PANTHERA TIGRIS Studbook Number: 223
 =====

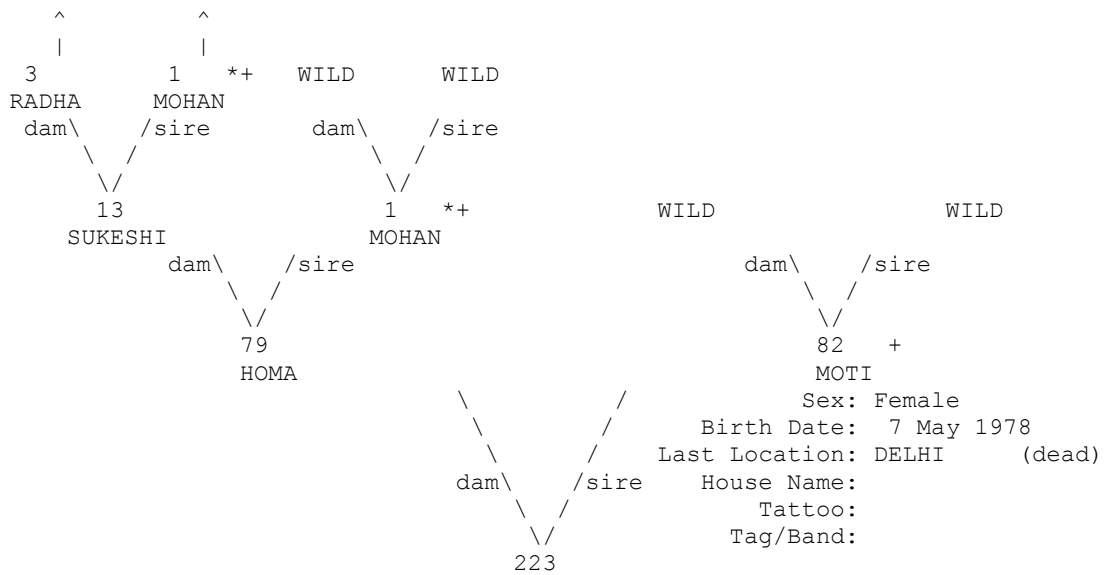

+ Wild-caught... * Appear more than once...
 ^ Pedigree continues beyond top of page...

=====
 Taxon Name: PANTHERA TIGRIS Studbook Number: 224
 =====

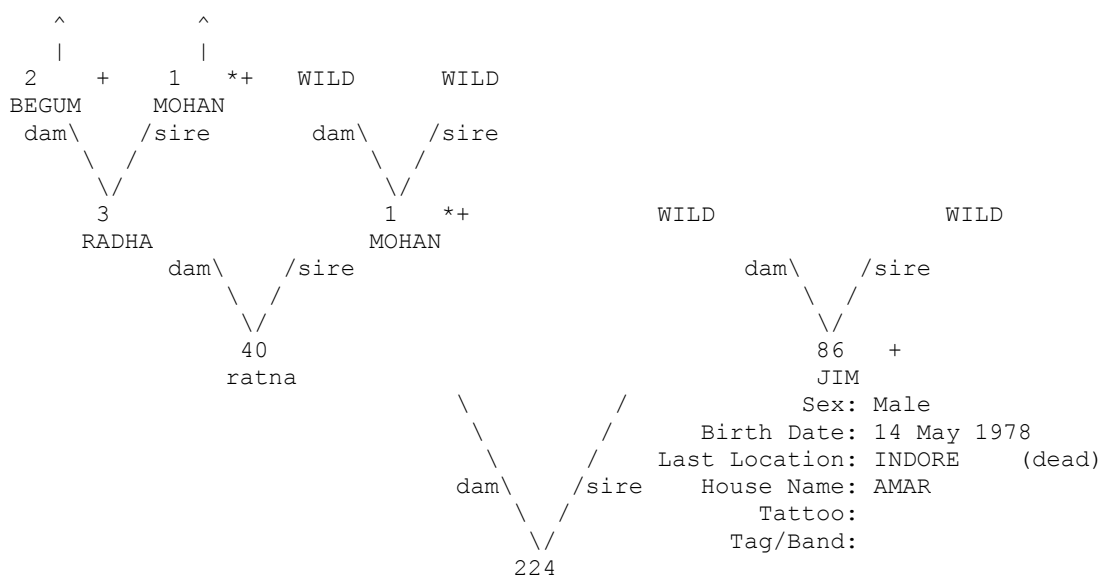

+ Wild-caught... * Appear more than once...
 ^ Pedigree continues beyond top of page...

=====
 Taxon Name: PANTHERA TIGRIS Studbook Number: 225
 =====

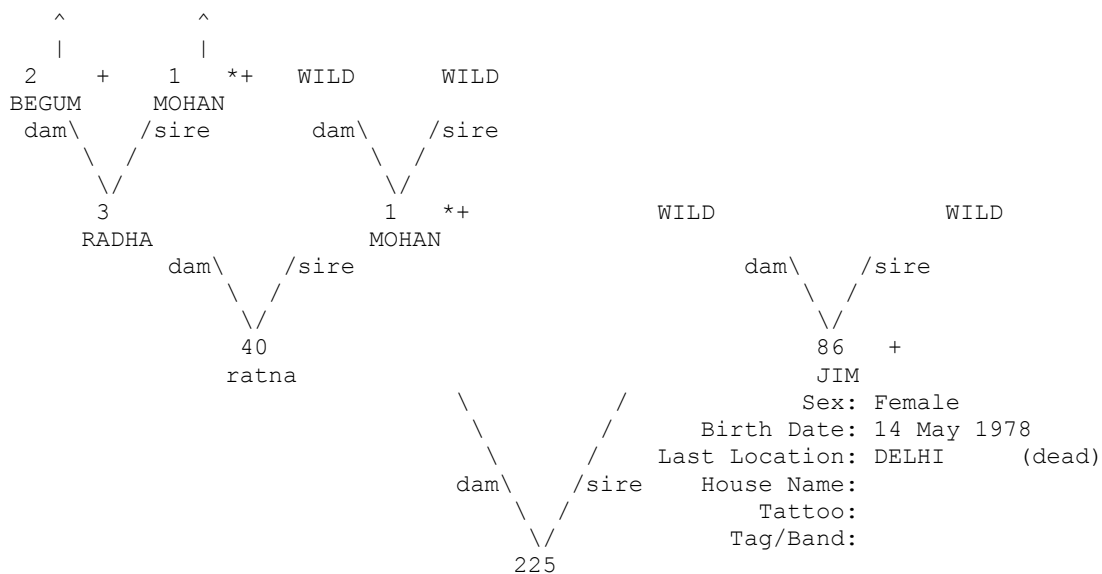

+ Wild-caught... * Appear more than once...
 ^ Pedigree continues beyond top of page...

=====
 Taxon Name: PANTHERA TIGRIS Studbook Number: 226
 =====

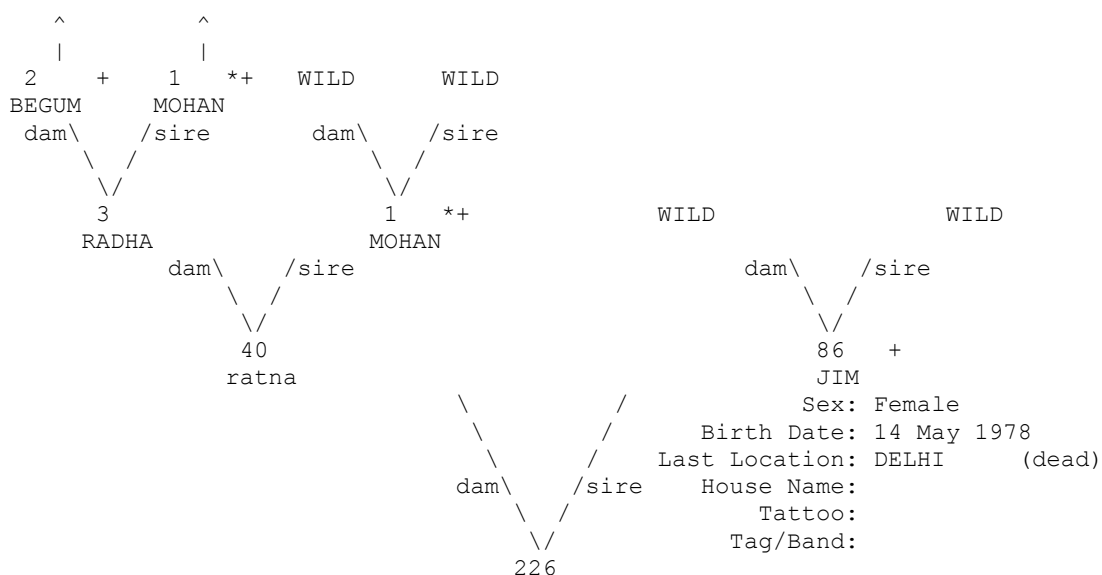

+ Wild-caught... * Appear more than once...
 ^ Pedigree continues beyond top of page...

=====
 Taxon Name: PANTHERA TIGRIS Studbook Number: 227
 =====

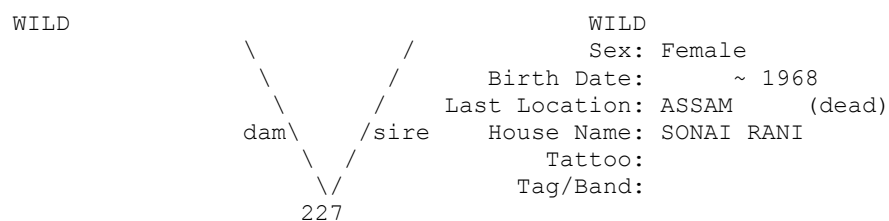

=====
 Taxon Name: PANTHERA TIGRIS Studbook Number: 228
 =====

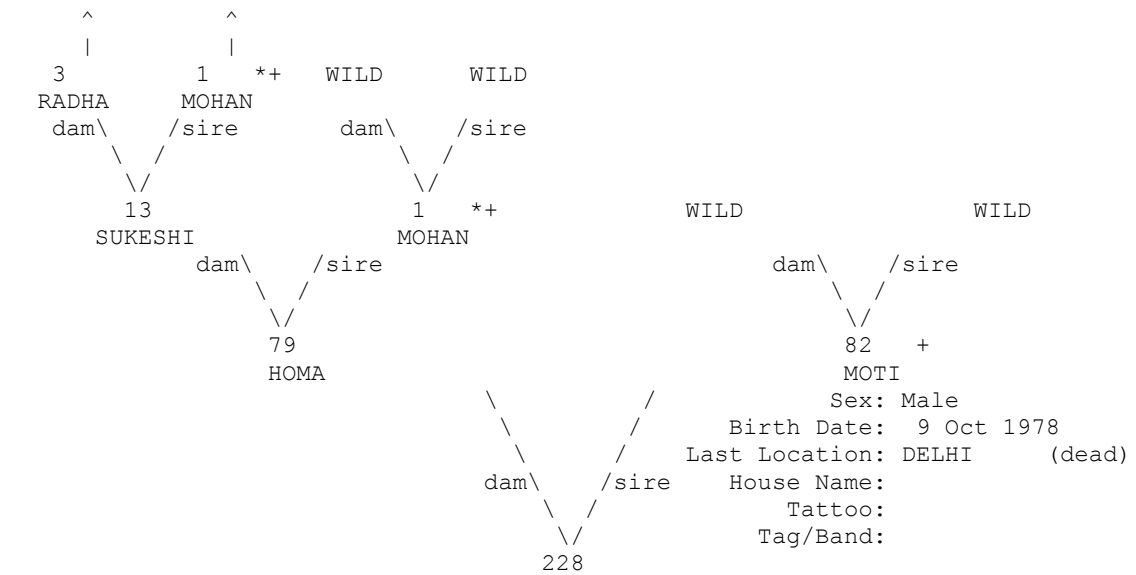

+ Wild-caught... * Appear more than once...
 ^ Pedigree continues beyond top of page...

=====
 Taxon Name: PANTHERA TIGRIS Studbook Number: 229
 =====

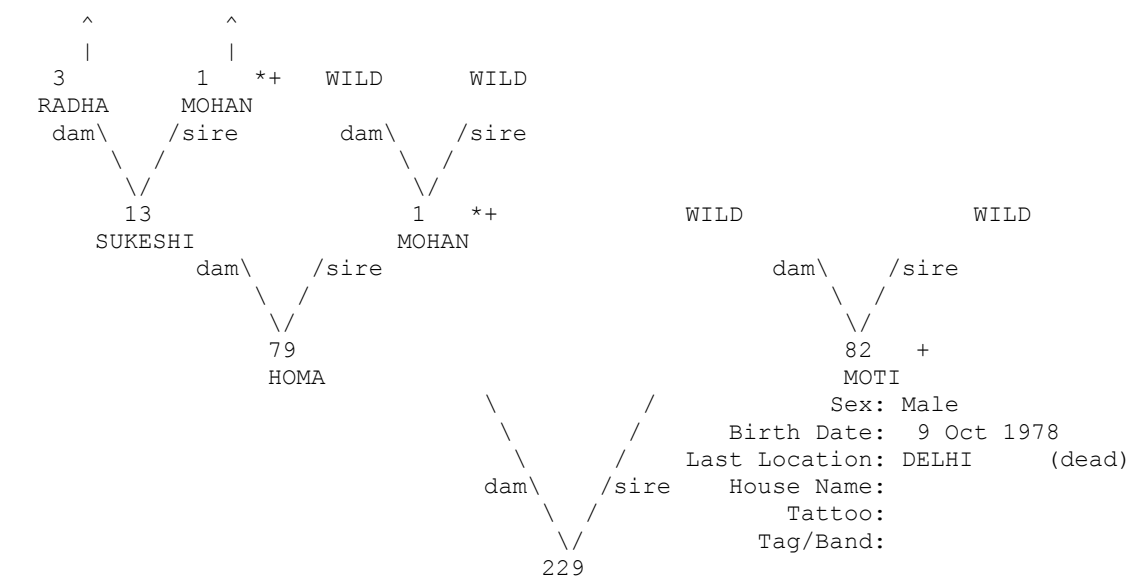

+ Wild-caught... * Appear more than once...
 ^ Pedigree continues beyond top of page...

=====
 Taxon Name: PANTHERA TIGRIS Studbook Number: 230
 =====

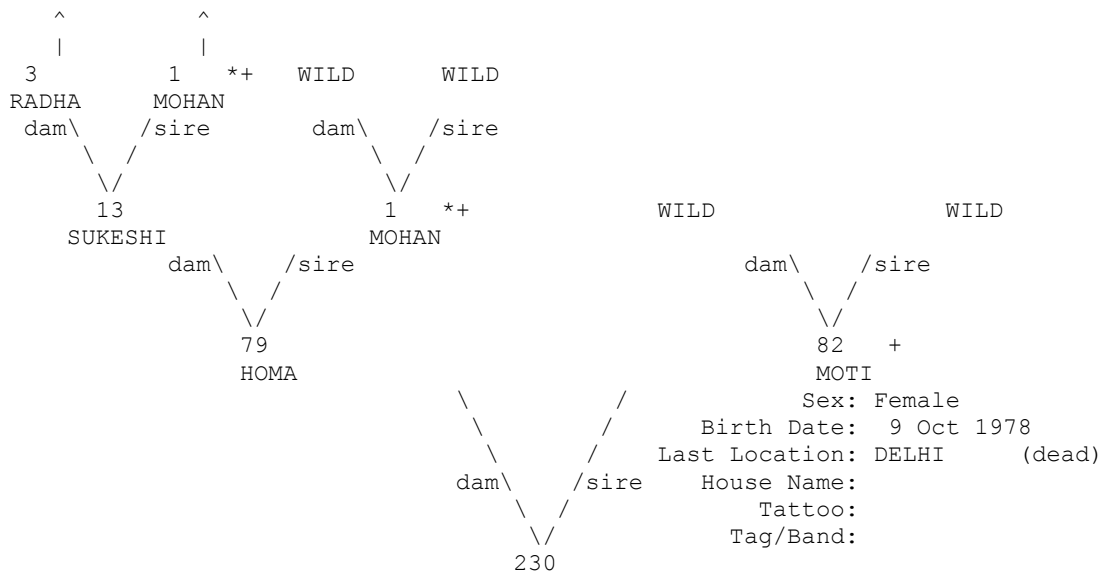

+ Wild-caught... * Appear more than once...
 ^ Pedigree continues beyond top of page...

=====
 Taxon Name: PANTHERA TIGRIS Studbook Number: 231
 =====

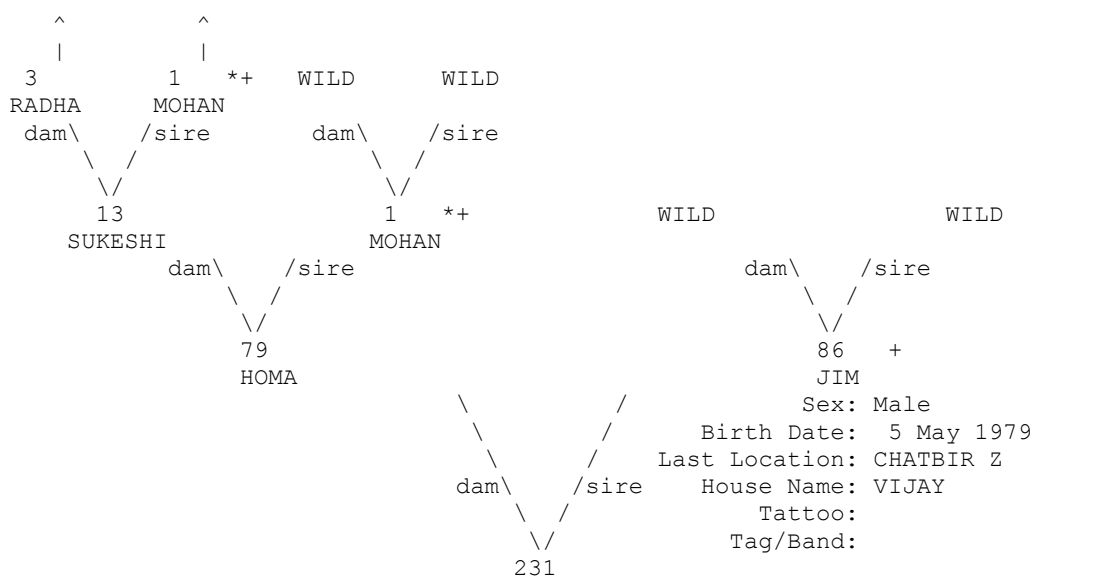

+ Wild-caught... * Appear more than once...
 ^ Pedigree continues beyond top of page...

=====
 Taxon Name: PANTHERA TIGRIS Studbook Number: 232
 =====

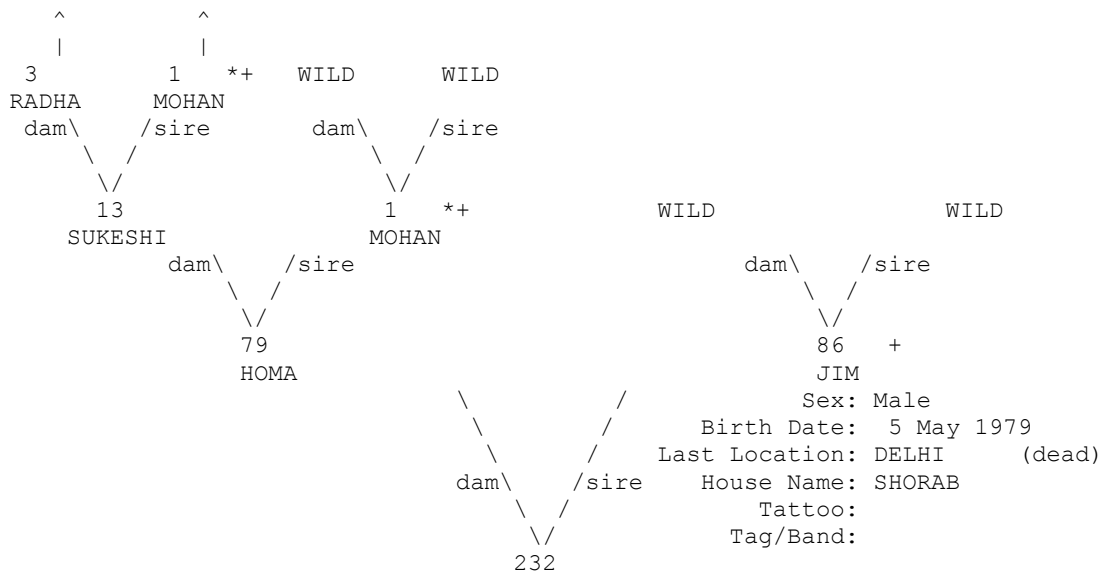

+ Wild-caught... * Appear more than once...
 ^ Pedigree continues beyond top of page...

=====
 Taxon Name: PANTHERA TIGRIS Studbook Number: 233
 =====

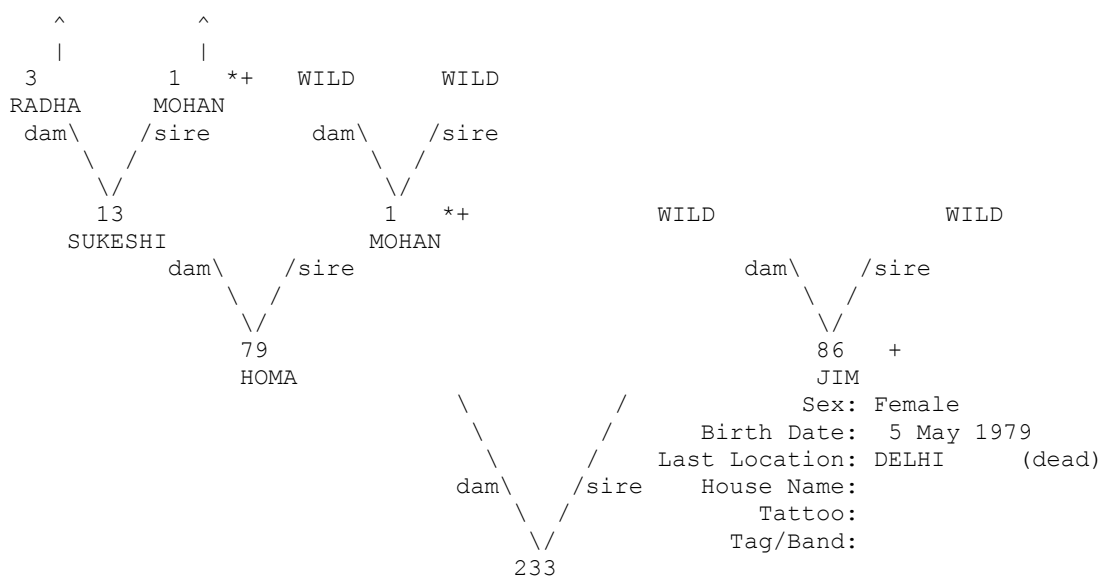

+ Wild-caught... * Appear more than once...
 ^ Pedigree continues beyond top of page...

=====
 Taxon Name: PANTHERA TIGRIS Studbook Number: 236
 =====

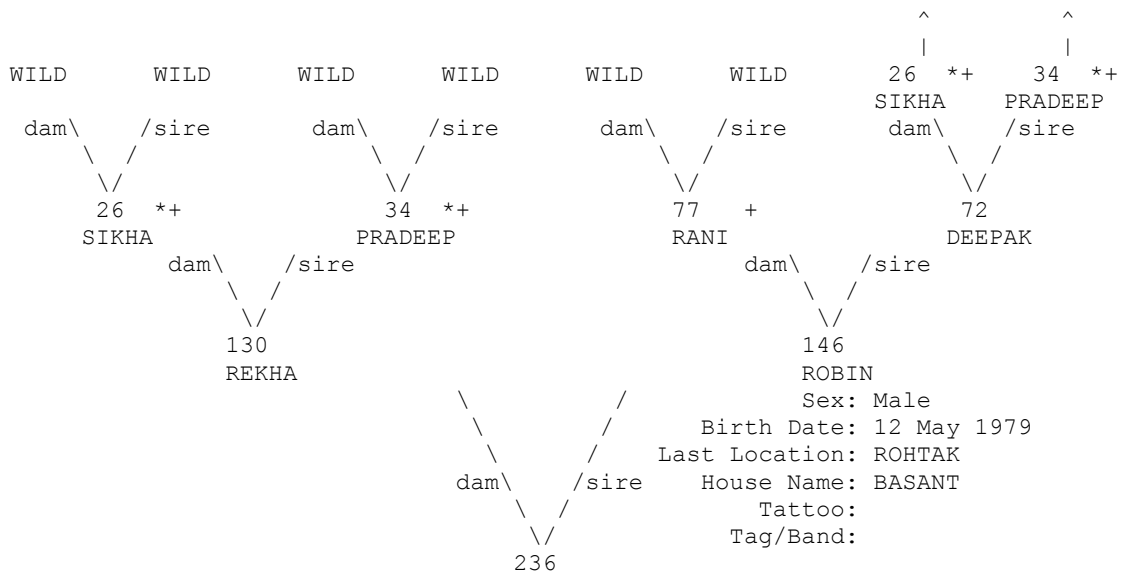

+ Wild-caught... * Appear more than once...
 ^ Pedigree continues beyond top of page...

=====
 Taxon Name: PANTHERA TIGRIS Studbook Number: 237
 =====

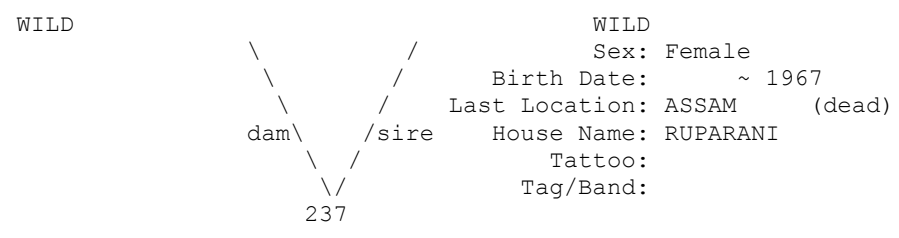

=====
 Taxon Name: PANTHERA TIGRIS Studbook Number: 238
 =====

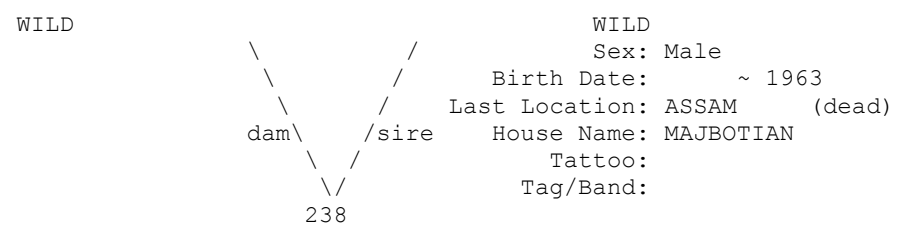

=====
Taxon Name: PANTHERA TIGRIS Studbook Number: 242
=====

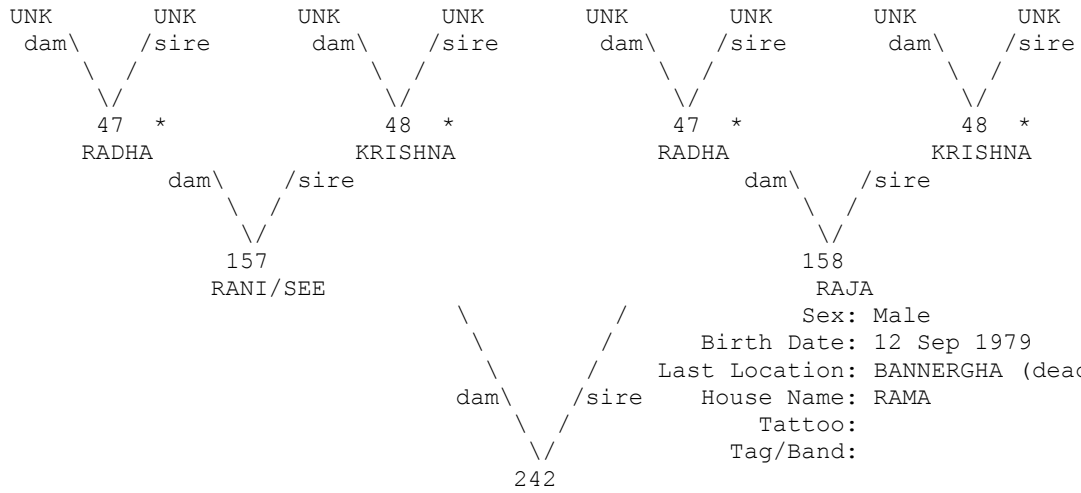

* Appear more than once...

=====
Taxon Name: PANTHERA TIGRIS Studbook Number: 243
=====

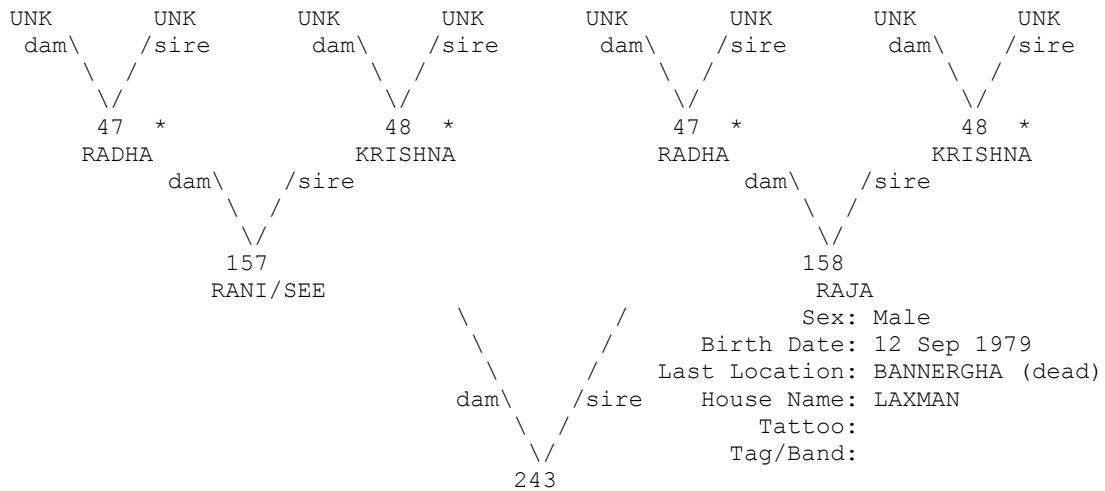

* Appear more than once...

=====
 Taxon Name: PANTHERA TIGRIS Studbook Number: 244
 =====

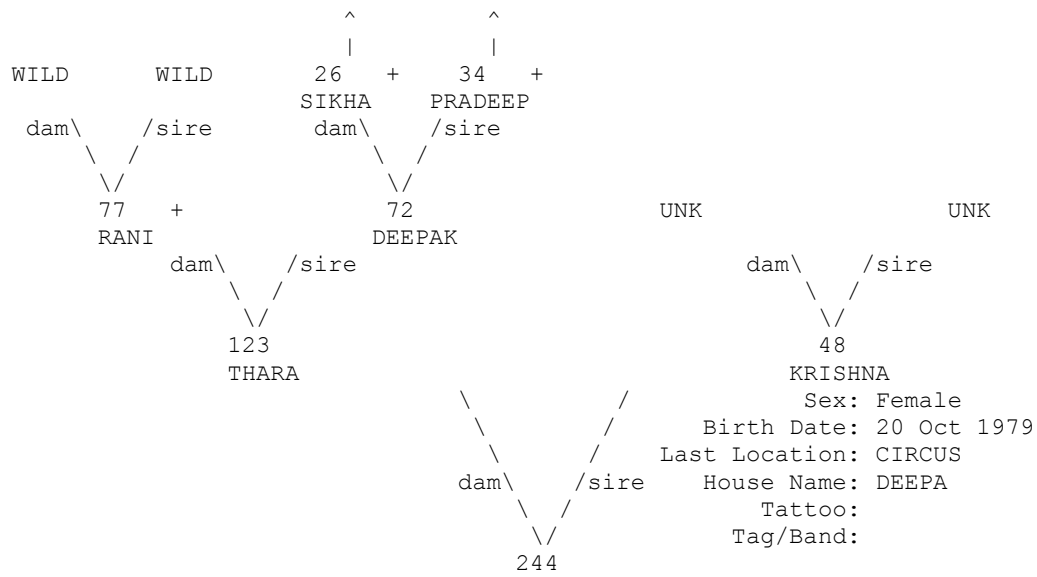

+ Wild-caught...
 ^ Pedigree continues beyond top of page...

=====
 Taxon Name: PANTHERA TIGRIS Studbook Number: 245
 =====

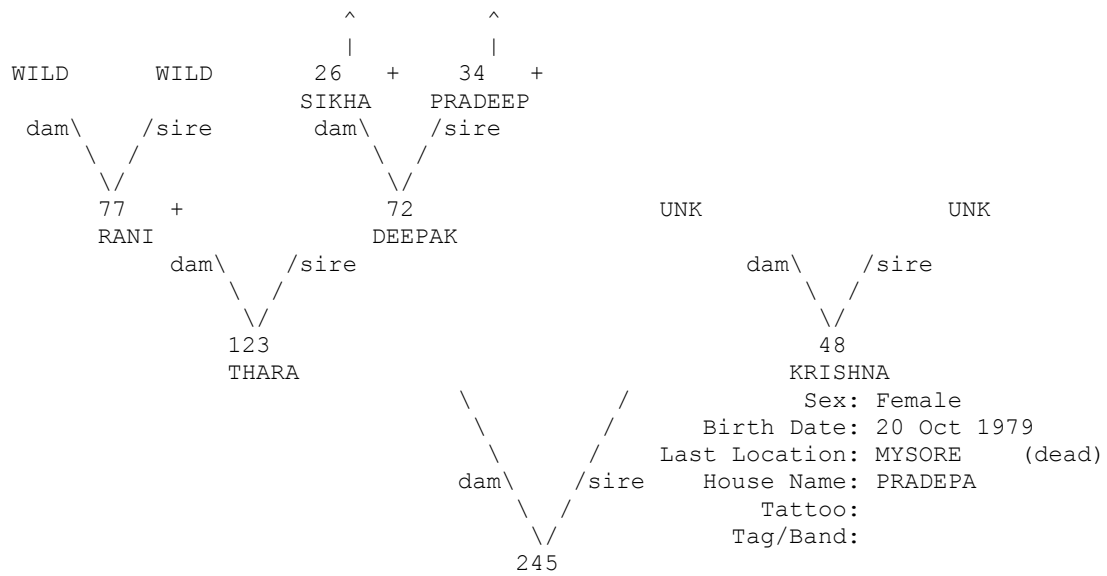

+ Wild-caught...
 ^ Pedigree continues beyond top of page...

=====
 Taxon Name: PANTHERA TIGRIS Studbook Number: 246
 =====

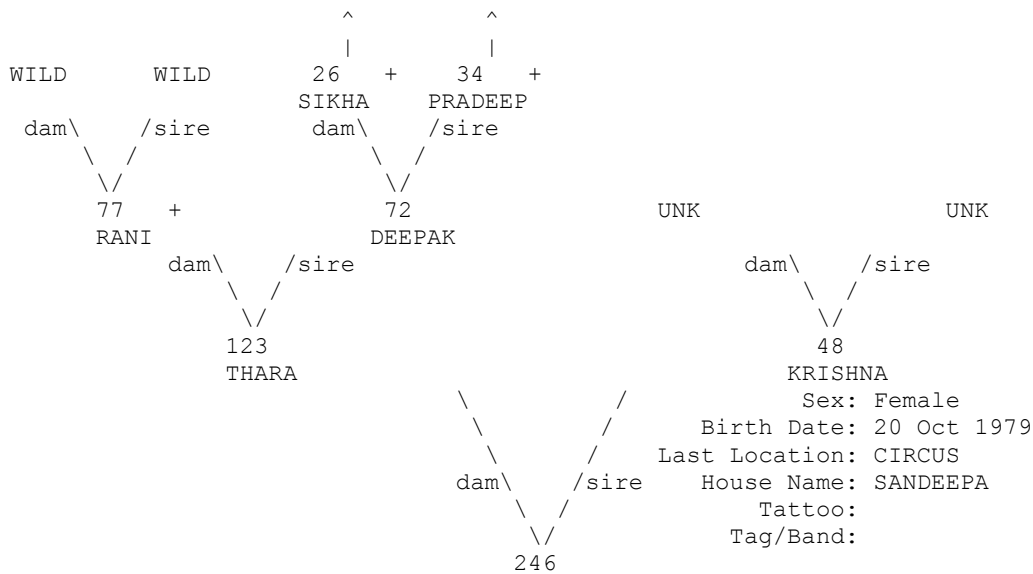

+ Wild-caught...
 ^ Pedigree continues beyond top of page...

=====
 Taxon Name: PANTHERA TIGRIS Studbook Number: 247
 =====

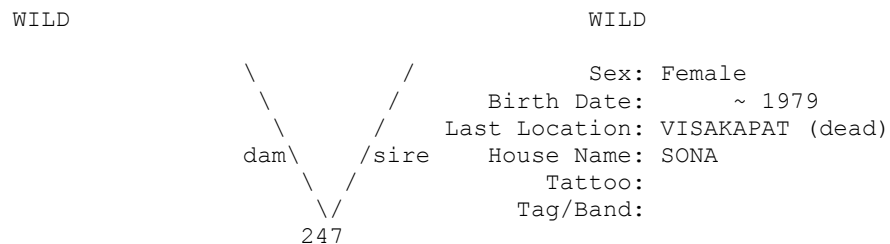

=====
 Taxon Name: PANTHERA TIGRIS Studbook Number: 248
 =====

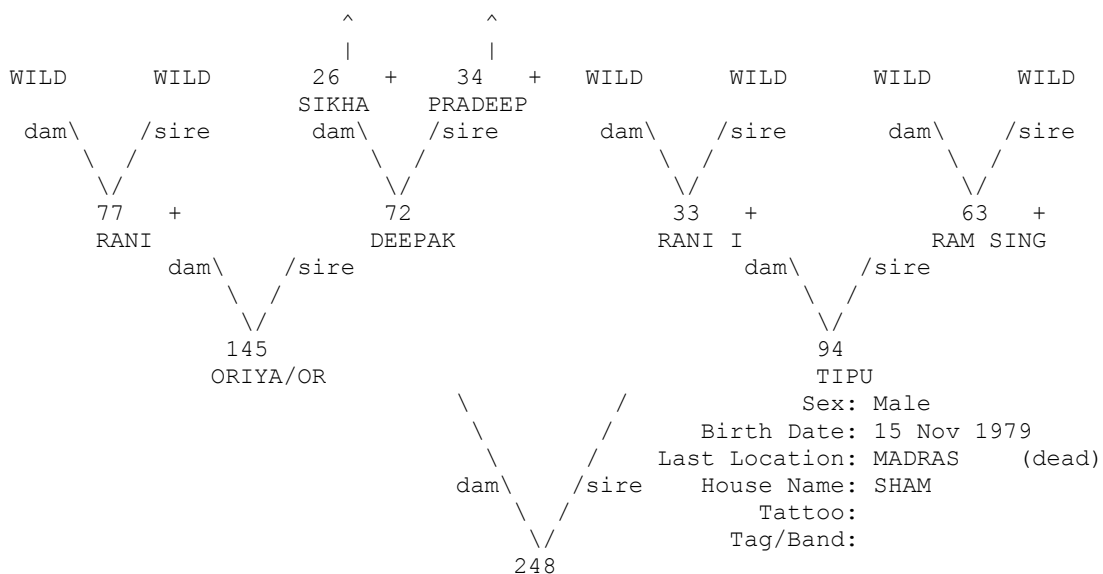

+ Wild-caught...
 ^ Pedigree continues beyond top of page..

=====
 Taxon Name: PANTHERA TIGRIS Studbook Number: 249
 =====

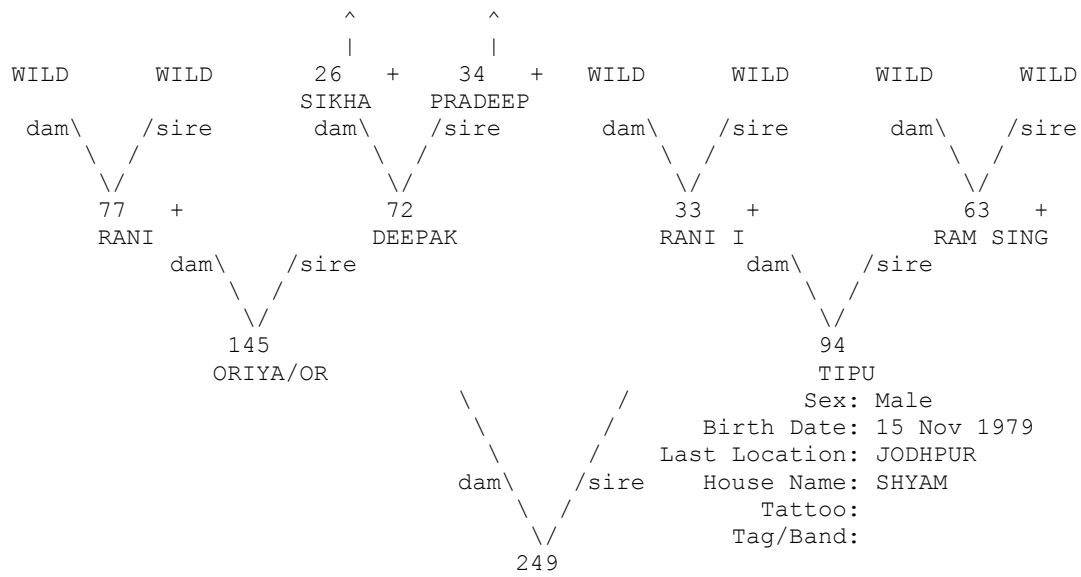

+ Wild-caught...
 ^ Pedigree continues beyond top of page...

=====
 Taxon Name: PANTHERA TIGRIS Studbook Number: 250
 =====

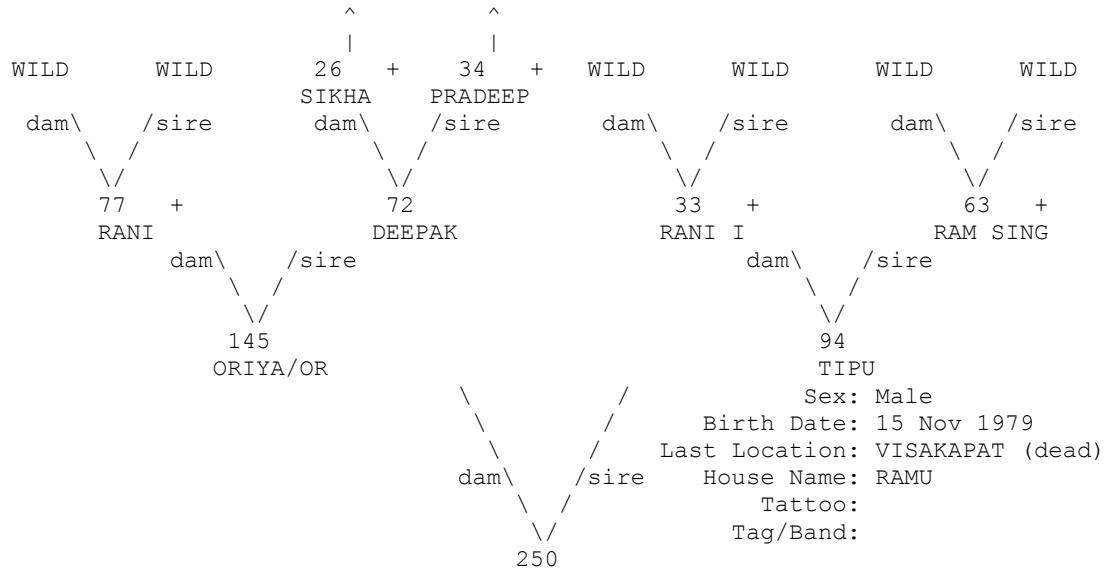

+ Wild-caught...
 ^ Pedigree continues beyond top of page...

=====
Taxon Name: PANTHERA TIGRIS Studbook Number: 257
=====

WILD

WILD



Sex: Male
Birth Date: ~ Jan 1980
Last Location: ASSAM (dead)
House Name: RAJKUMAR/sanay
Tattoo:
Tag/Band:

=====
Taxon Name: PANTHERA TIGRIS Studbook Number: 258
=====

WILD

WILD

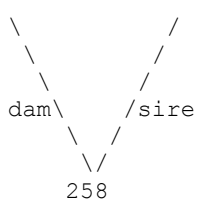

Sex: Female
Birth Date: ~ 1980
Last Location: ASSAM (dead)
House Name: RANI/LAKHI
Tattoo:
Tag/Band:

=====
Taxon Name: PANTHERA TIGRIS Studbook Number: 259
=====

UNK

UNK

UNK

UNK

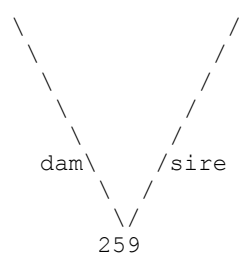
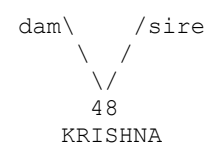
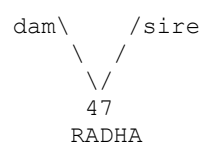

Sex: Male
Birth Date: 4 Jul 1980
Last Location: DEALER
House Name: TIPPU
Tattoo:
Tag/Band:

=====
Taxon Name: PANTHERA TIGRIS Studbook Number: 260
=====

UNK

UNK

UNK

UNK

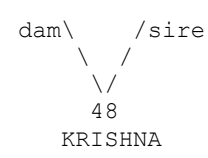
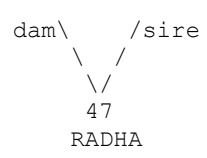

Sex: Female
Birth Date: 4 Jul 1980
Last Location: MYSORE (dead)
House Name: MUMTAJ
Tattoo:
Tag/Band:

=====

Taxon Name: PANTHERA TIGRIS

Studbook Number: 261

=====

UNK UNK UNK UNK

dam\ /sire

 \ /

 47

 RADHA

\ /

 dam\ /sire

 \ /

 261

dam\ /sire

 \ /

 48

 KRISHNA

 Sex: Male

 Birth Date: 4 Jul 1980

 Last Location: MYSORE (dead)

 House Name: SAFDAR

 Tattoo:

 Tag/Band:

=====

Taxon Name: PANTHERA TIGRIS

Studbook Number: 262

=====

UNK UNK UNK UNK

dam\ /sire

 \ /

 47

 RADHA

\ /

 dam\ /sire

 \ /

 262

dam\ /sire

 \ /

 48

 KRISHNA

 Sex: Male

 Birth Date: 4 Jul 1980

 Last Location: MYSORE (dead)

 House Name: GUMNAJ

 Tattoo:

 Tag/Band:

=====

Taxon Name: PANTHERA TIGRIS

Studbook Number: 263

=====

WILD WILD WILD WILD

dam\ /sire

 \ /

 161 +

 SITA/GEE

\ /

 dam\ /sire

 \ /

 263

dam\ /sire

 \ /

 82 +

 MOTI

 Sex: Male

 Birth Date: 19 Jul 1980

 Last Location: CHATBIR Z (dead)

 House Name: RAJU/RAJA

 Tattoo:

 Tag/Band:

+ Wild-caught...

=====
 Taxon Name: PANTHERA TIGRIS Studbook Number: 264
 =====

```

WILD dam\ /sire WILD WILD dam\ /sire WILD
      \  /      \  /      \  /      \  /
       161 +      82 +
      SITA/GEE      MOTI
                   Sex: Male
                   Birth Date: 19 Jul 1980
                   Last Location: DELHI (dead)
                   House Name:
                   Tattoo:
                   Tag/Band:

dam\ /sire
 \  /
  264
  
```

+ Wild-caught...

=====
 Taxon Name: PANTHERA TIGRIS Studbook Number: 265
 =====

```

WILD dam\ /sire WILD WILD dam\ /sire WILD
      \  /      \  /      \  /      \  /
       161 +      82 +
      SITA/GEE      MOTI
                   Sex: Female
                   Birth Date: 19 Jul 1980
                   Last Location: CHATBIR Z
                   House Name: RUPA
                   Tattoo:
                   Tag/Band:

dam\ /sire
 \  /
  265
  
```

+ Wild-caught...

=====
 Taxon Name: PANTHERA TIGRIS Studbook Number: 266
 =====

```

WILD WILD
      \  /      \  /
       dam\ /sire
        \  /
         266
          Sex: Male
          Birth Date: ????
          Last Location: CALCUTTA (dead)
          House Name: AJAY
          Tattoo:
          Tag/Band:
  
```

=====
 Taxon Name: PANTHERA TIGRIS Studbook Number: 267
 =====

```

UNK UNK
      \  /      \  /
       dam\ /sire
        \  /
         267
          Sex: Male
          Birth Date: ????
          Last Location: CHATBIR Z (dead)
          House Name: BALRAM
          Tattoo:
          Tag/Band:
  
```

=====
 Taxon Name: PANTHERA TIGRIS Studbook Number: 268
 =====

WILDH2

WILDH1

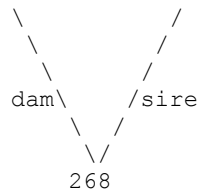

Sex: Male
 Birth Date: ~ 1980
 Last Location: BANNERGHA (dead)
 House Name: SANJAY
 Tattoo:
 Tag/Band:

=====
 Taxon Name: PANTHERA TIGRIS Studbook Number: 269
 =====

WILDH2

WILDH1

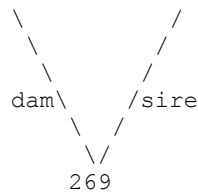

Sex: Male
 Birth Date: ~ 1980
 Last Location: HYDERABAD (dead)
 House Name: ARJUN
 Tattoo:
 Tag/Band:

=====
 Taxon Name: PANTHERA TIGRIS Studbook Number: 270
 =====

WILDH1*

WILDH1*

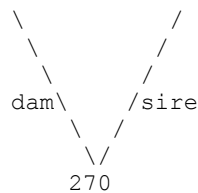

Sex: Female
 Birth Date: ~ 1980
 Last Location: HYDERABAD (dead)
 House Name: SHEELA
 Tattoo:
 Tag/Band:

* Appear more than once...

=====
 Taxon Name: PANTHERA TIGRIS Studbook Number: 271
 =====

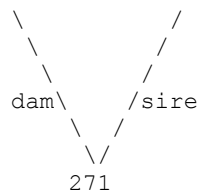
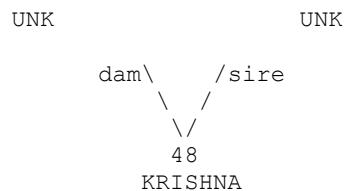
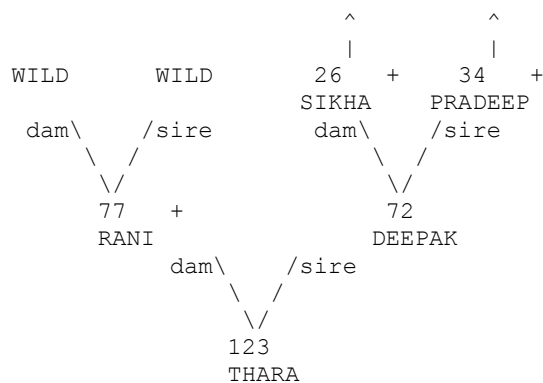

Sex: Male
 Birth Date: 29 Jan 1981
 Last Location: VADODARA (dead)
 House Name: MADHU
 Tattoo:
 Tag/Band:

+ Wild-caught...

^ Pedigree continues beyond top of page...

=====
 Taxon Name: PANTHERA TIGRIS Studbook Number: 272
 =====

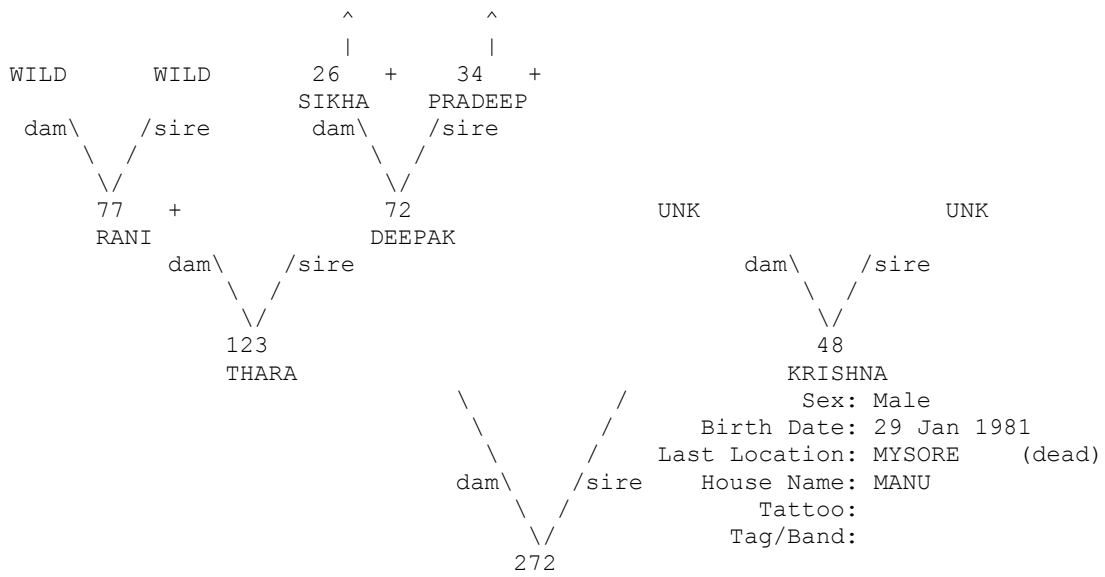

+ Wild-caught...
 ^ Pedigree continues beyond top of page...

=====
 Taxon Name: PANTHERA TIGRIS Studbook Number: 273
 =====

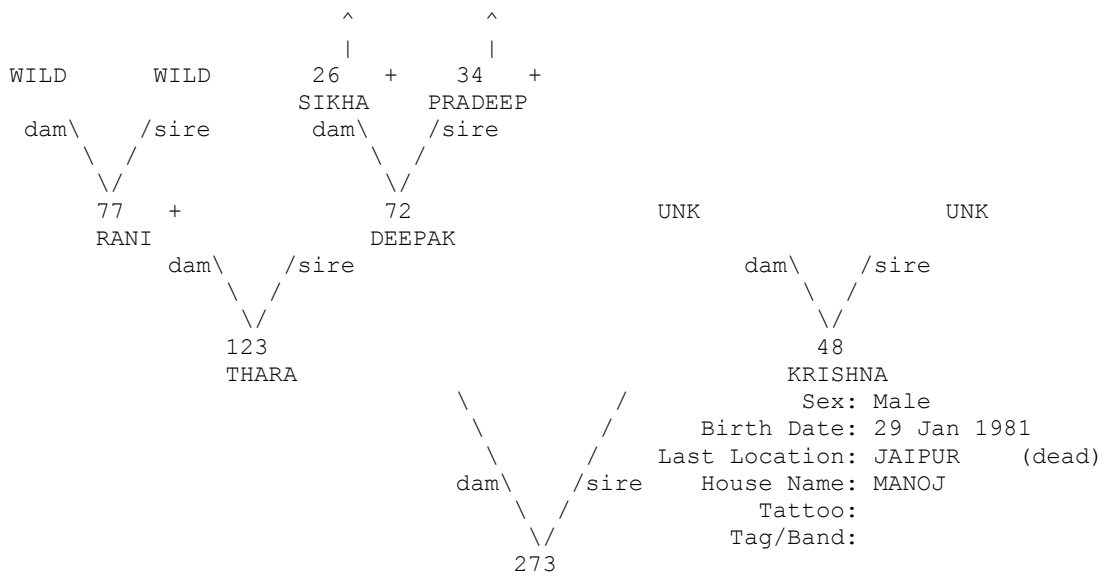

+ Wild-caught...
 ^ Pedigree continues beyond top of page...

=====
 Taxon Name: PANTHERA TIGRIS Studbook Number: 274
 =====

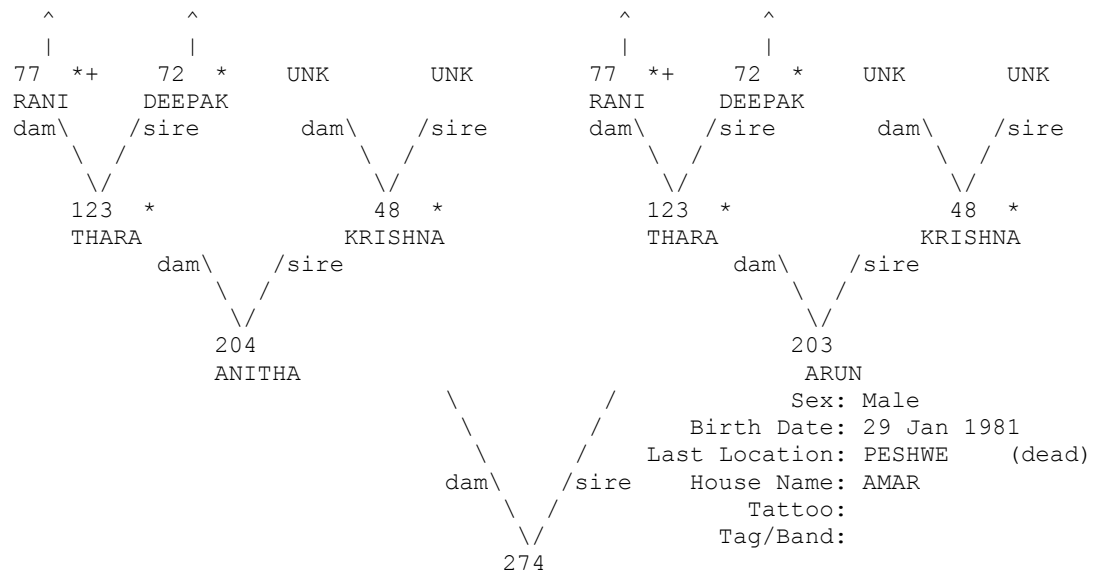

+ Wild-caught... * Appear more than once...
 ^ Pedigree continues beyond top of page...

=====
 Taxon Name: PANTHERA TIGRIS Studbook Number: 275
 =====

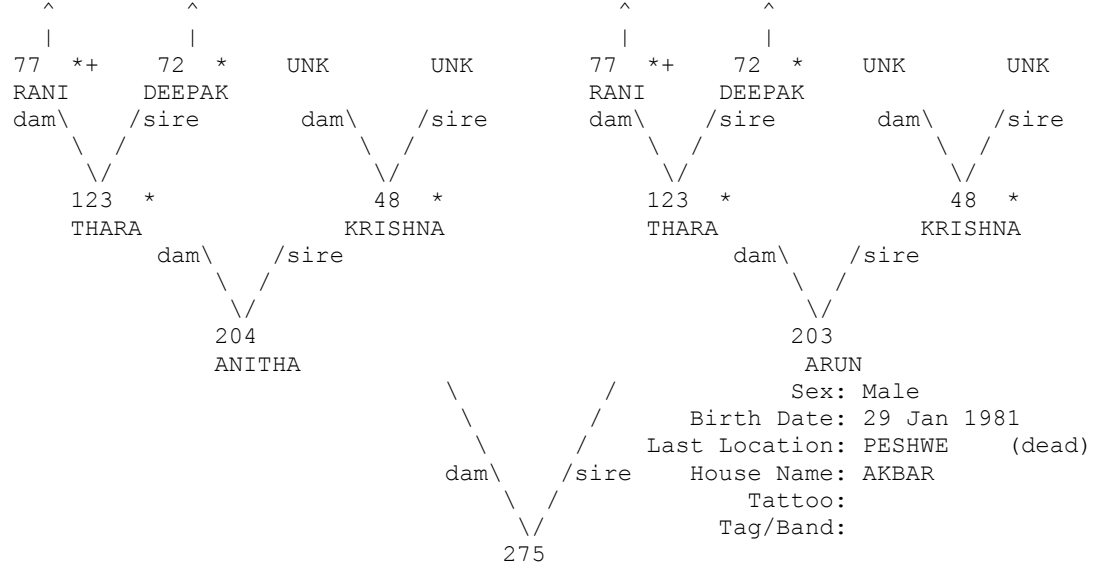

+ Wild-caught... * Appear more than once...
 ^ Pedigree continues beyond top of page...

=====
 Taxon Name: PANTHERA TIGRIS Studbook Number: 276
 =====

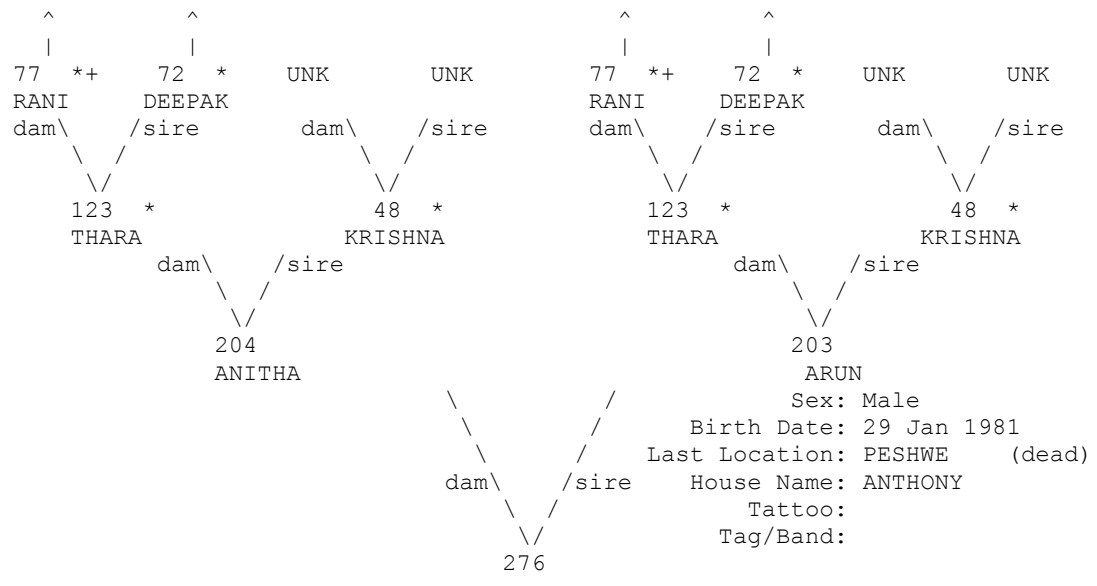

+ Wild-caught... * Appear more than once...
 ^ Pedigree continues beyond top of page...

=====
 Taxon Name: PANTHERA TIGRIS Studbook Number: 277
 =====

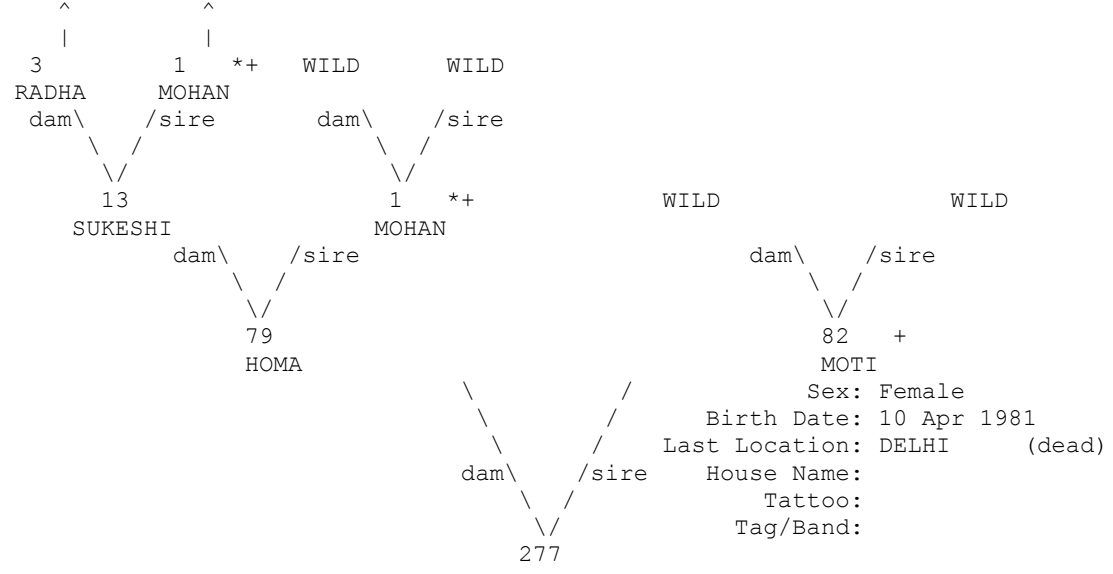

+ Wild-caught... * Appear more than once...
 ^ Pedigree continues beyond top of page...

=====
Taxon Name: PANTHERA TIGRIS

Studbook Number: 278
=====

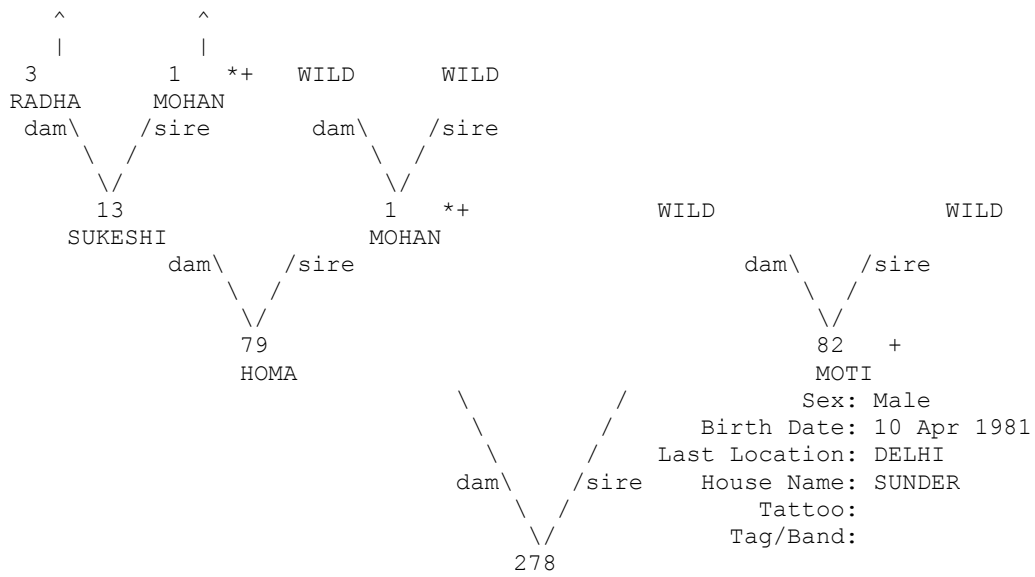

+ Wild-caught... * Appear more than once...

^ Pedigree continues beyond top of page...

=====
Taxon Name: PANTHERA TIGRIS

Studbook Number: 279
=====

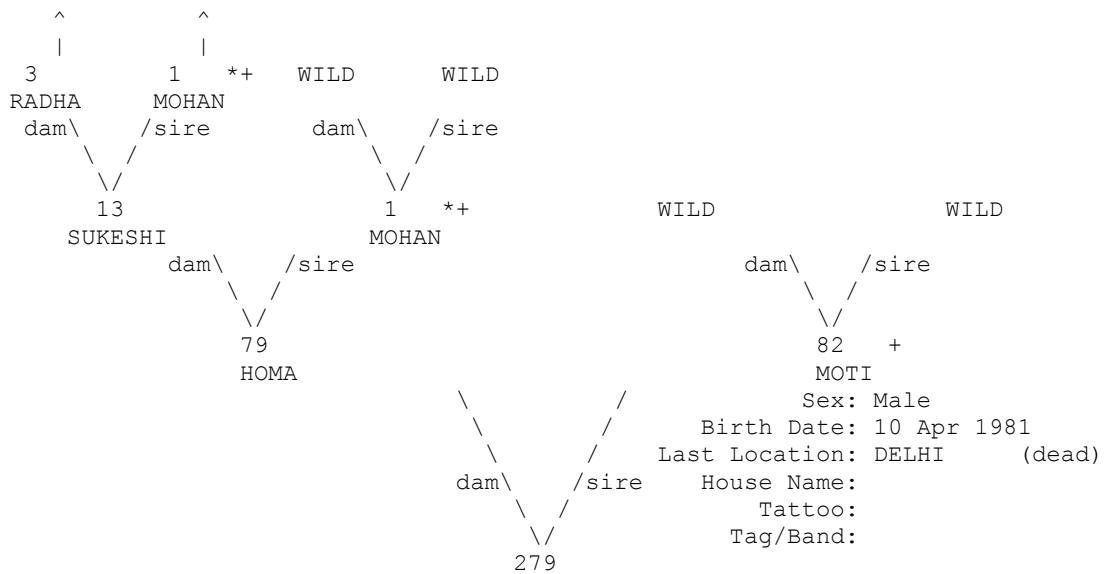

+ Wild-caught... * Appear more than once...

^ Pedigree continues beyond top of page...

=====
 Taxon Name: PANTHERA TIGRIS Studbook Number: 280
 =====

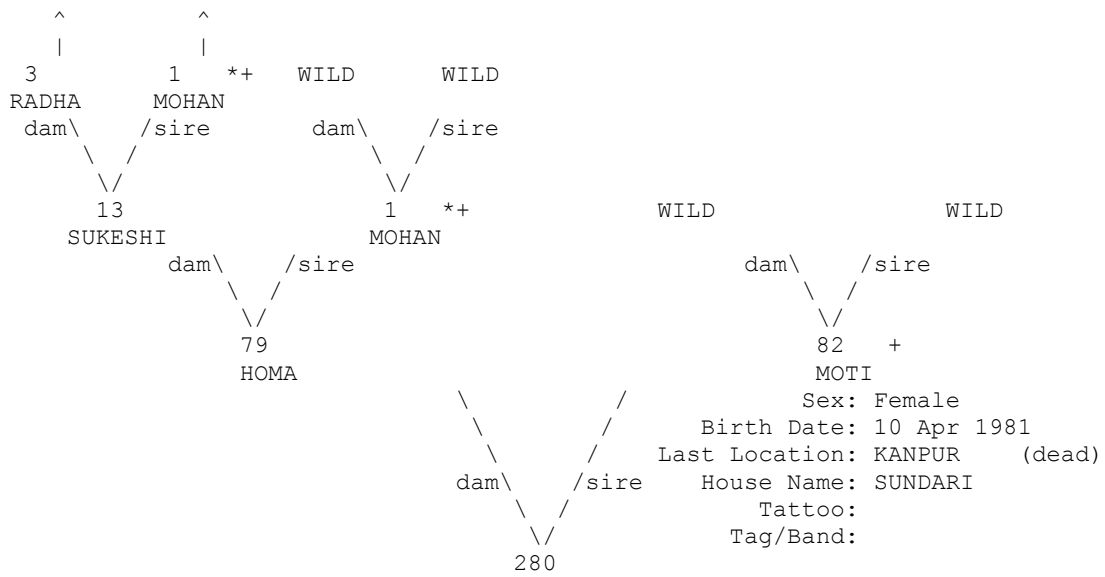

+ Wild-caught... * Appear more than once...
 ^ Pedigree continues beyond top of page...

=====
 Taxon Name: PANTHERA TIGRIS Studbook Number: 281
 =====

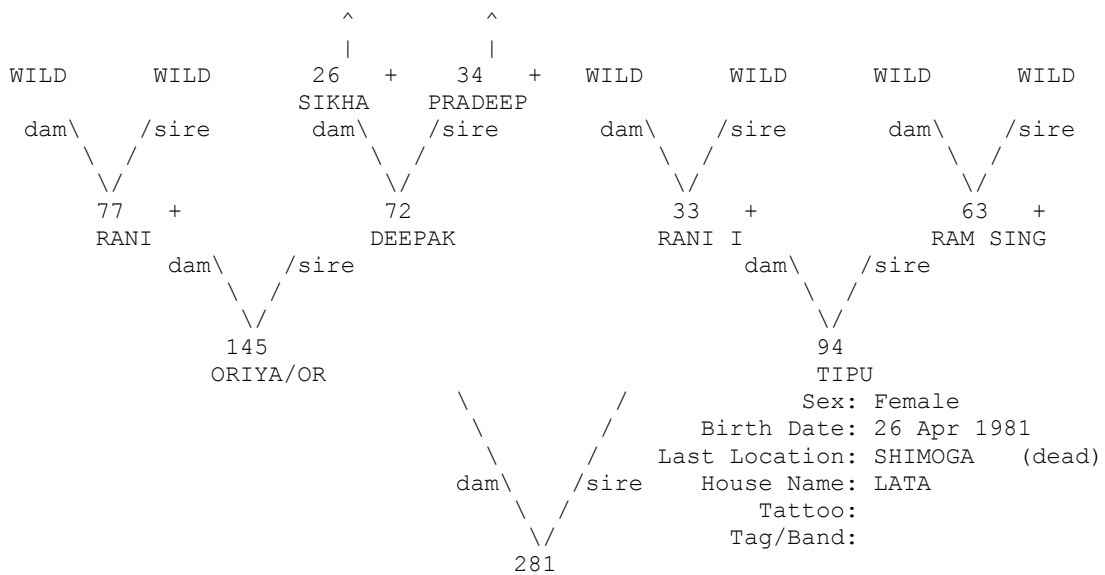

+ Wild-caught...
 ^ Pedigree continues beyond top of page...

=====
 Taxon Name: PANTHERA TIGRIS Studbook Number: 282
 =====

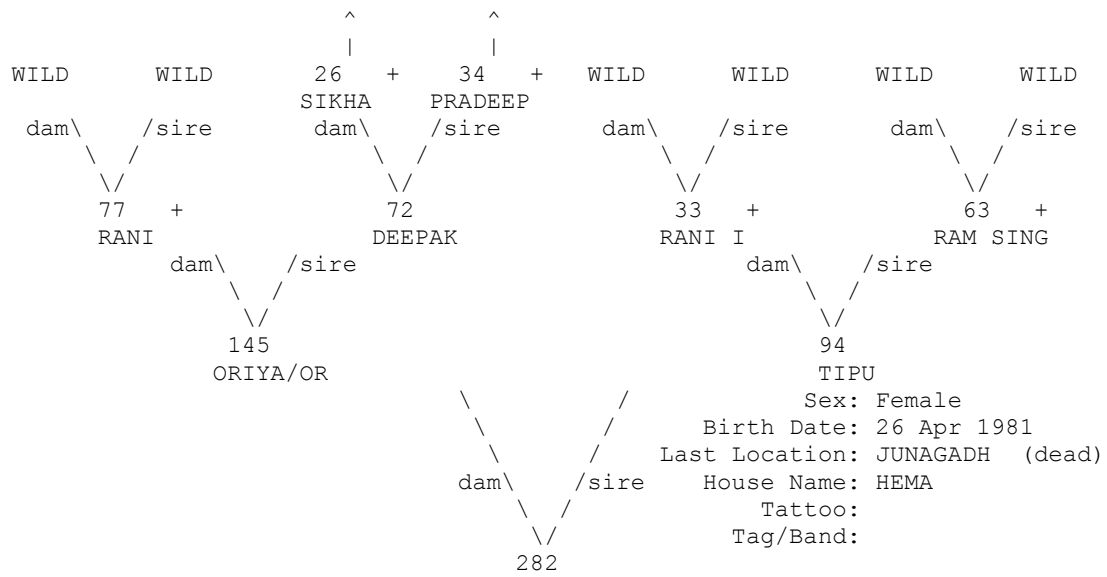

+ Wild-caught...
 ^ Pedigree continues beyond top of page...

=====
 Taxon Name: PANTHERA TIGRIS Studbook Number: 283
 =====

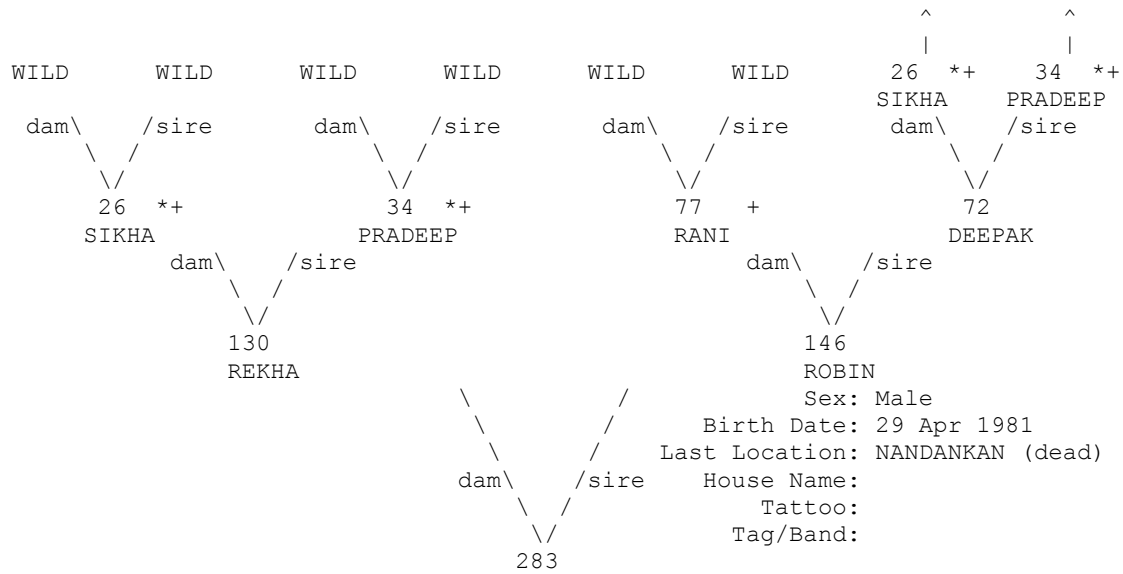

+ Wild-caught... * Appear more than once...
 ^ Pedigree continues beyond top of page...

=====
 Taxon Name: PANTHERA TIGRIS Studbook Number: 284
 =====

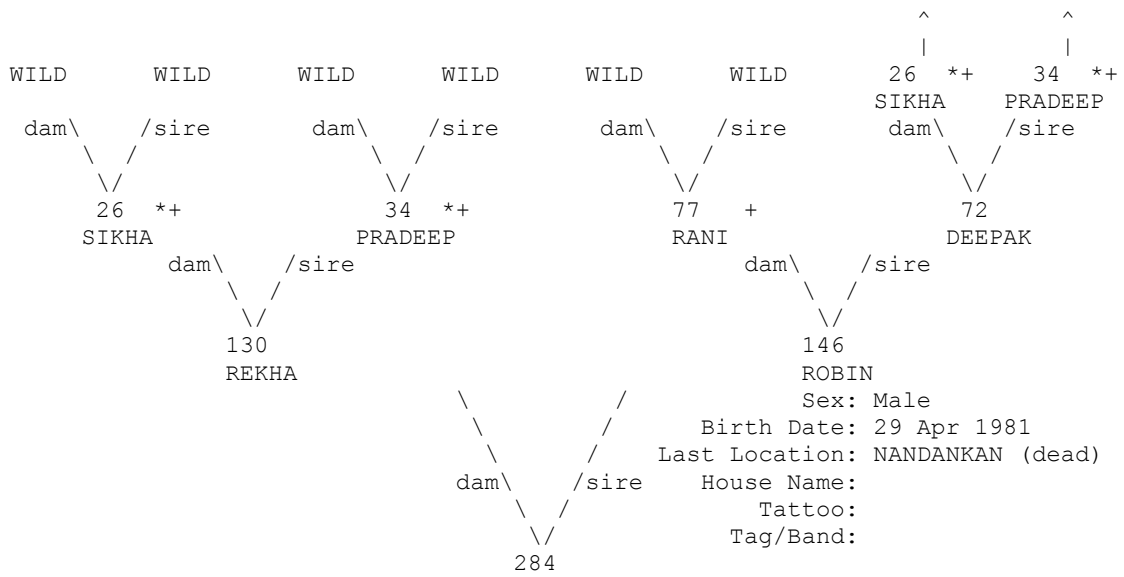

+ Wild-caught... * Appear more than once...
 ^ Pedigree continues beyond top of page...

=====
 Taxon Name: PANTHERA TIGRIS Studbook Number: 285
 =====

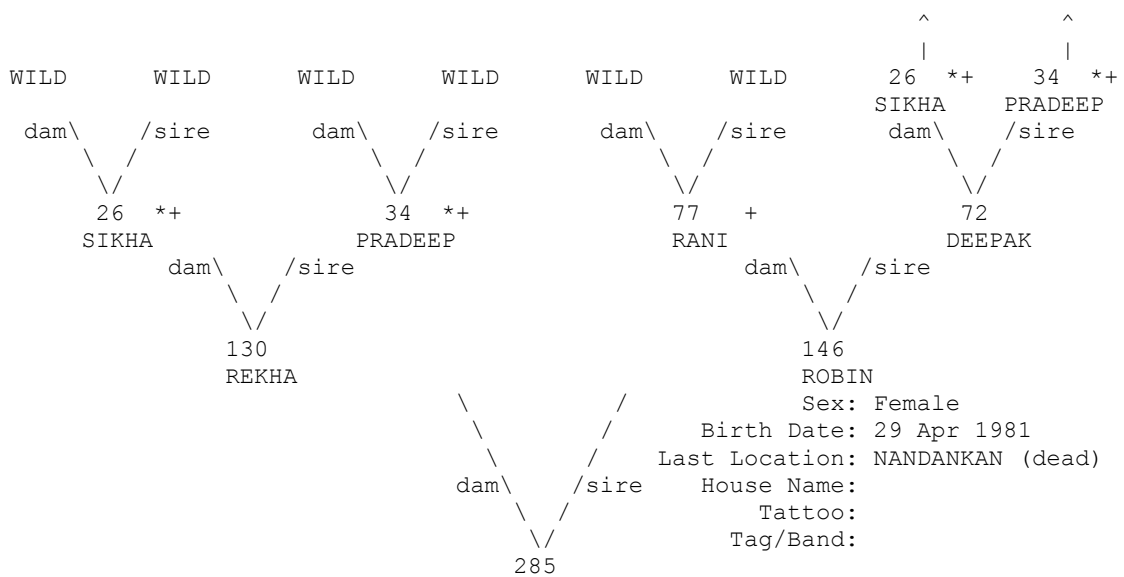

+ Wild-caught... * Appear more than once...
 ^ Pedigree continues beyond top of page...

=====
 Taxon Name: PANTHERA TIGRIS Studbook Number: 288
 =====

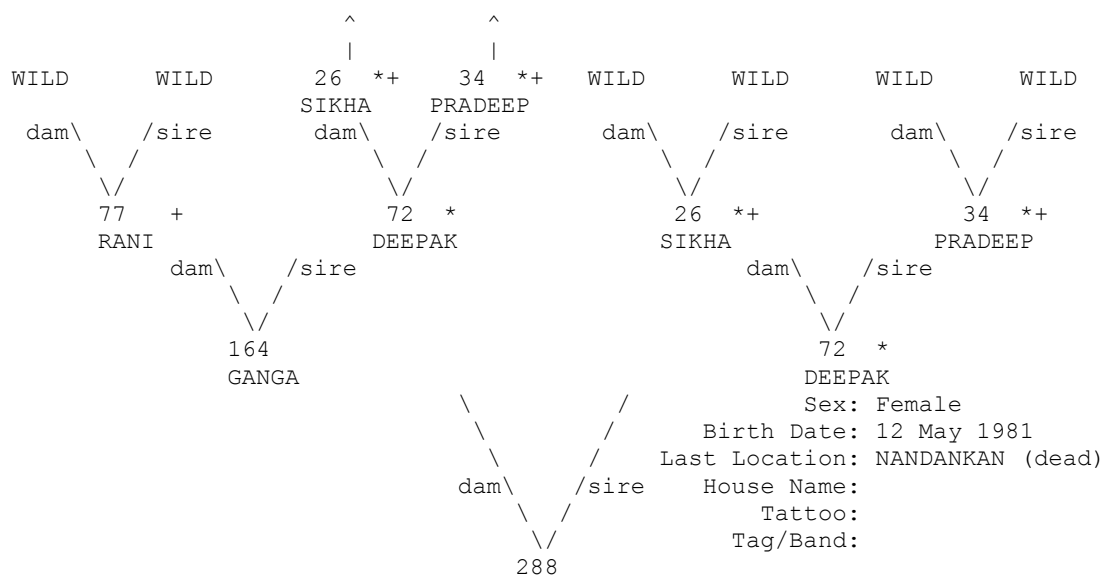

+ Wild-caught... * Appear more than once...
 ^ Pedigree continues beyond top of page...

=====
 Taxon Name: PANTHERA TIGRIS Studbook Number: 289
 =====

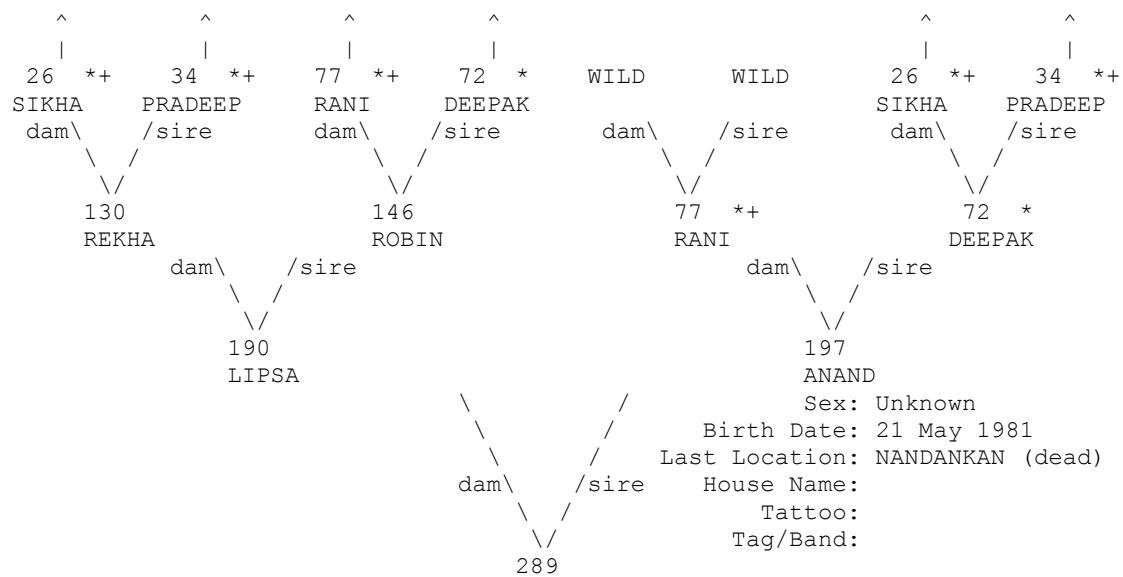

+ Wild-caught... * Appear more than once...
 ^ Pedigree continues beyond top of page...

=====
 Taxon Name: PANTHERA TIGRIS Studbook Number: 290
 =====

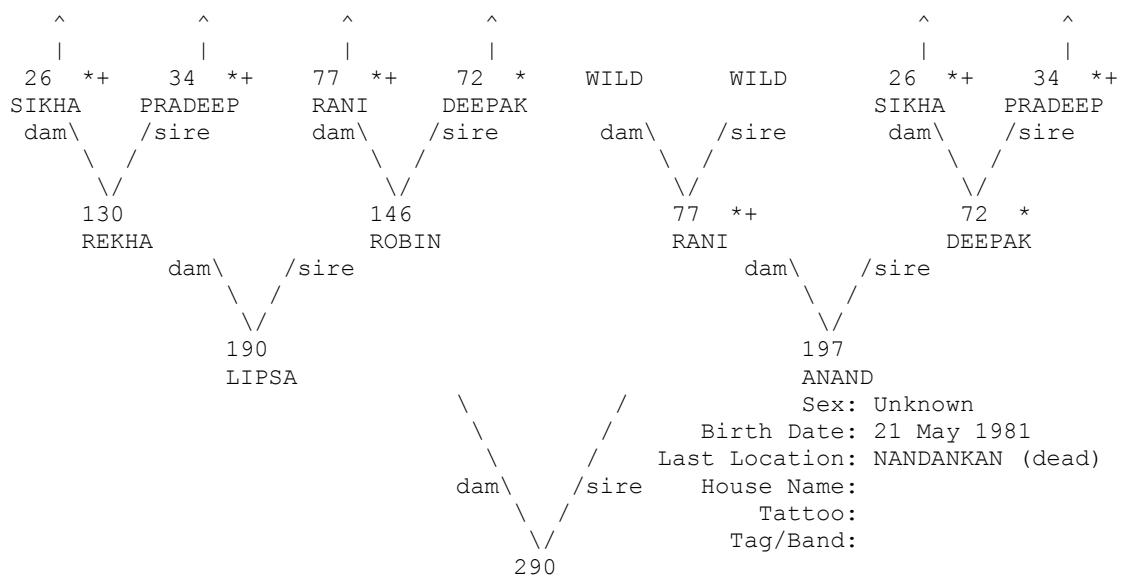

+ Wild-caught... * Appear more than once...
 ^ Pedigree continues beyond top of page...

=====
 Taxon Name: PANTHERA TIGRIS Studbook Number: 291
 =====

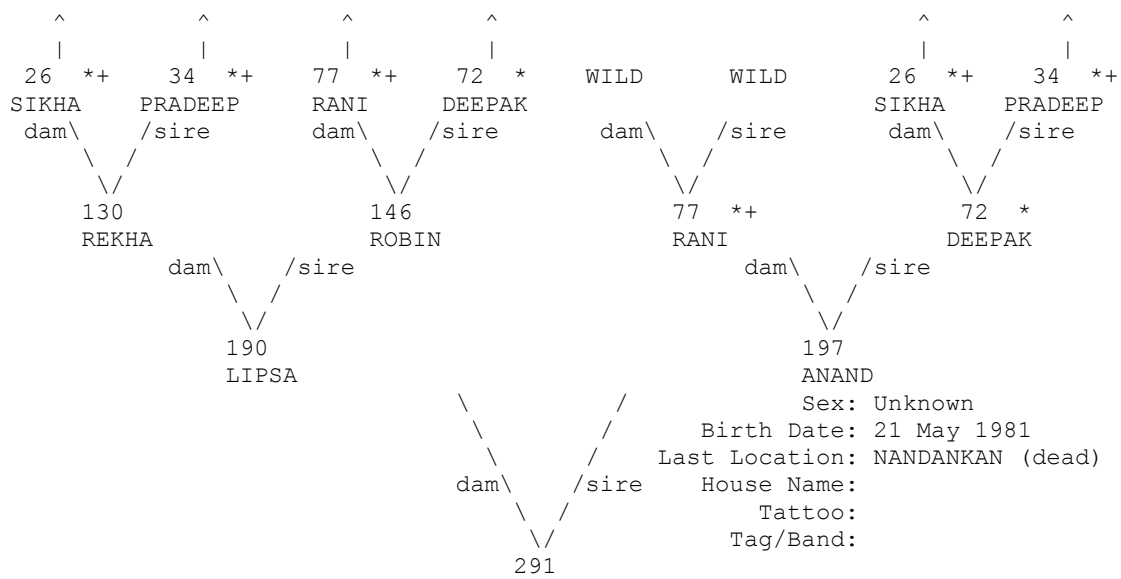

+ Wild-caught... * Appear more than once...
 ^ Pedigree continues beyond top of page...

=====
 Taxon Name: PANTHERA TIGRIS Studbook Number: 294
 =====

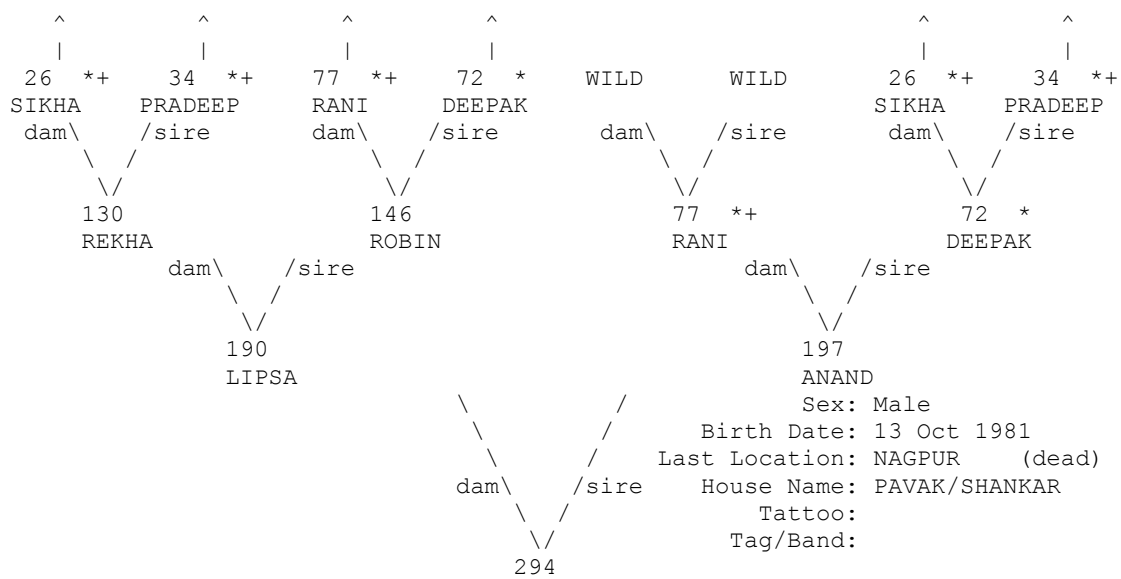

+ Wild-caught... * Appear more than once...
 ^ Pedigree continues beyond top of page...

=====
 Taxon Name: PANTHERA TIGRIS Studbook Number: 295
 =====

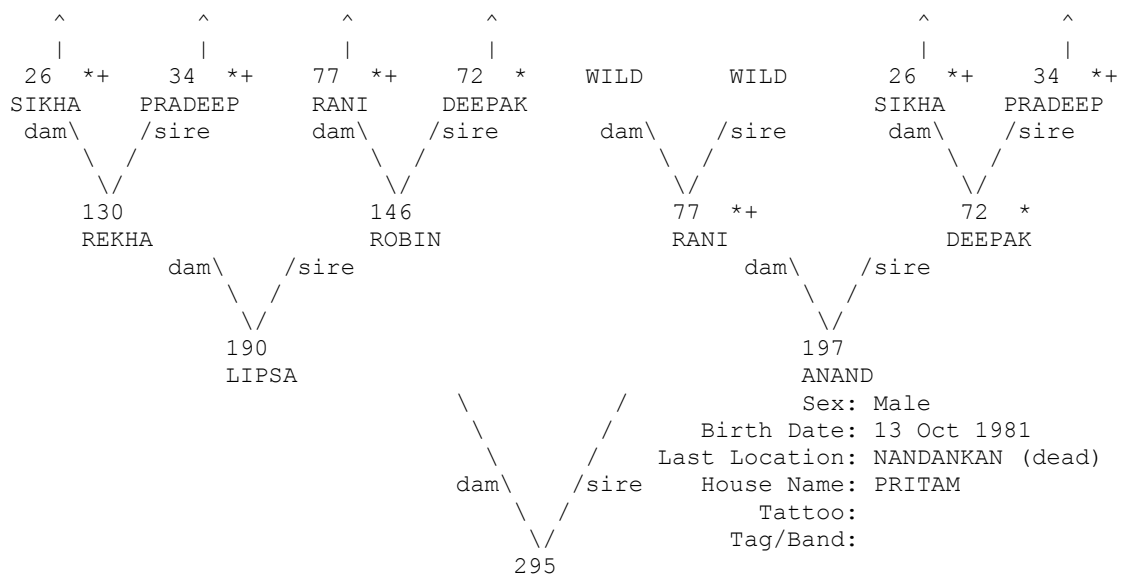

+ Wild-caught... * Appear more than once...
 ^ Pedigree continues beyond top of page...

=====
 Taxon Name: PANTHERA TIGRIS Studbook Number: 296
 =====

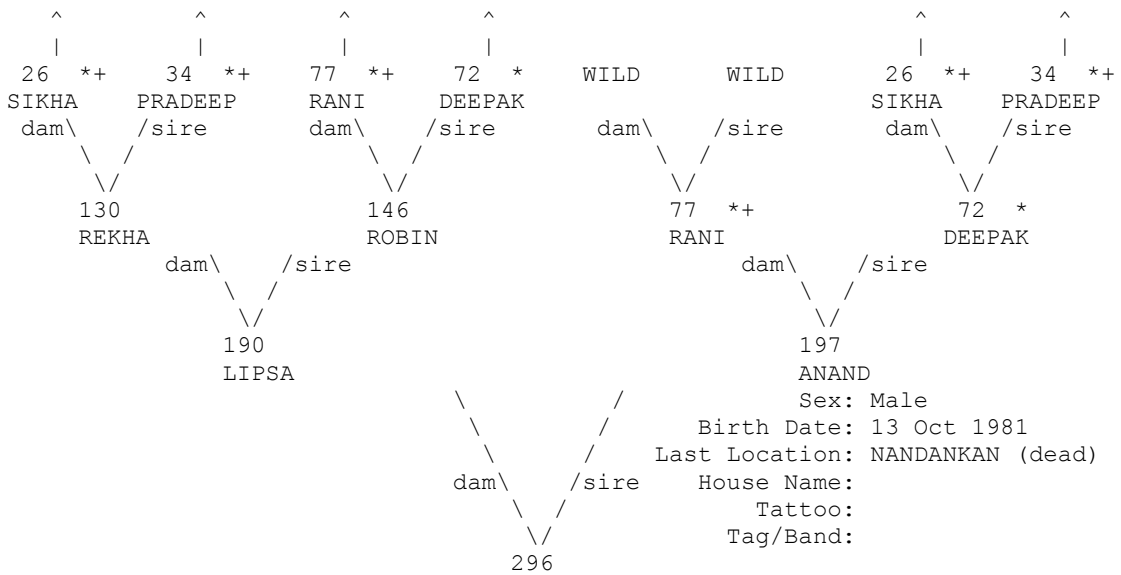

+ Wild-caught... * Appear more than once...
 ^ Pedigree continues beyond top of page...

=====
 Taxon Name: PANTHERA TIGRIS Studbook Number: 297
 =====

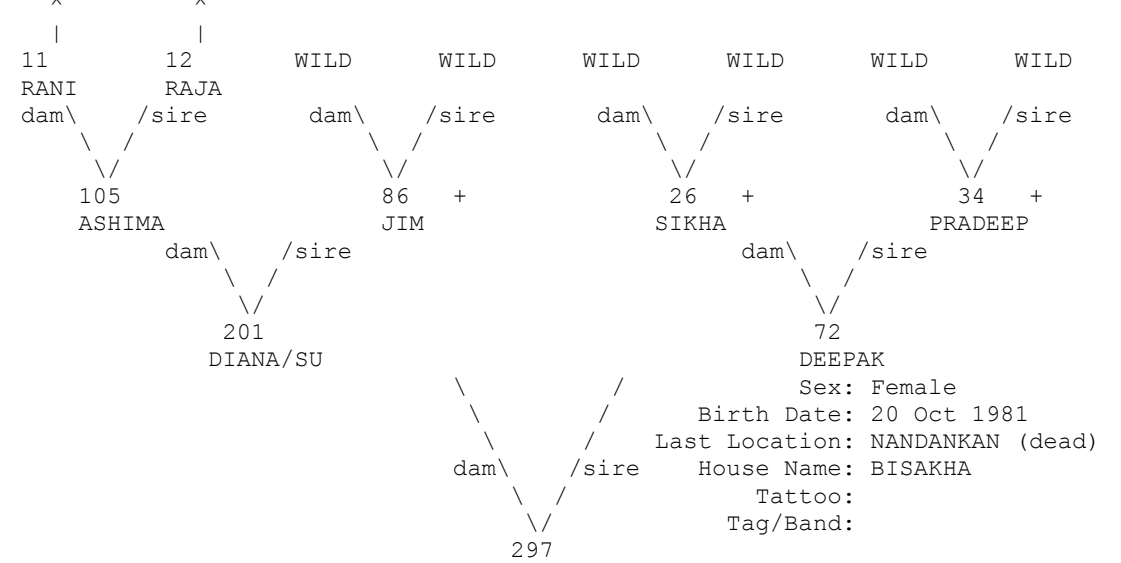

+ Wild-caught... * Appear more than once...
 ^ Pedigree continues beyond top of page...

=====
 Taxon Name: PANTHERA TIGRIS Studbook Number: 298
 =====

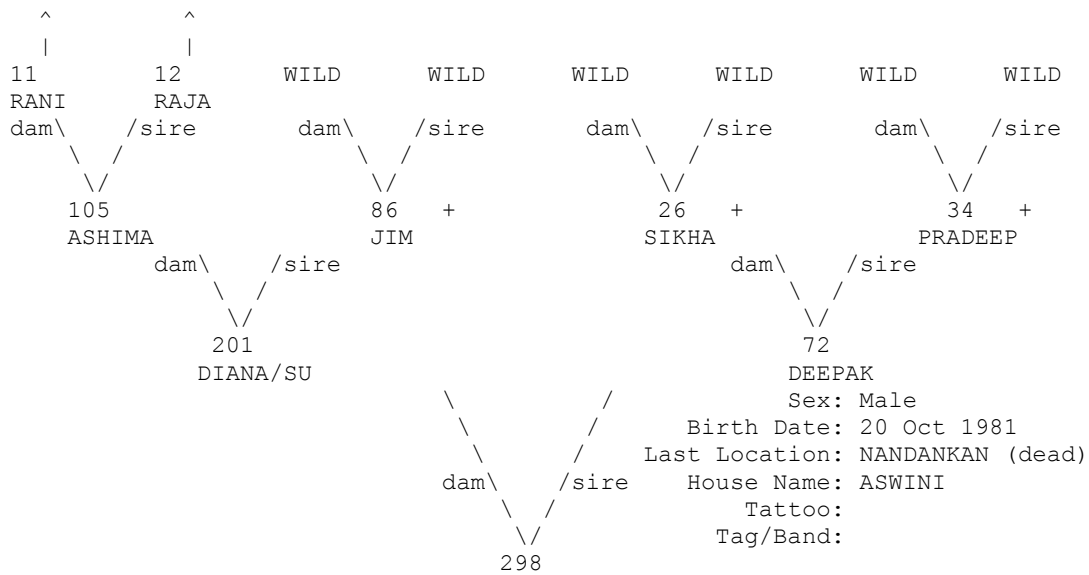

+ Wild-caught... * Appear more than once...
 ^ Pedigree continues beyond top of page...

=====
 Taxon Name: PANTHERA TIGRIS Studbook Number: 299
 =====

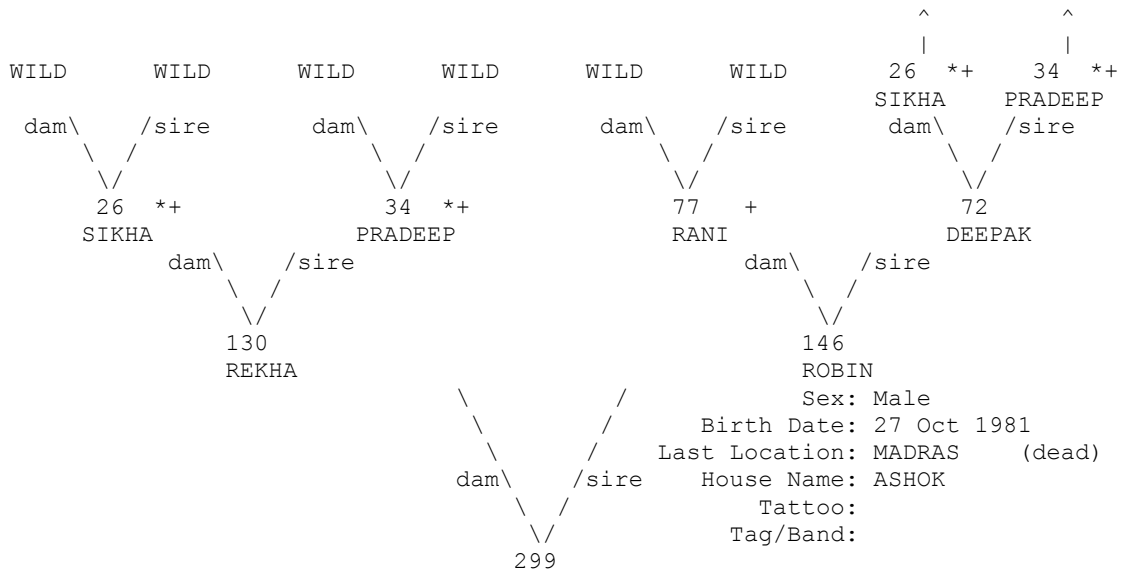

+ Wild-caught... * Appear more than once...
 ^ Pedigree continues beyond top of page...

=====
 Taxon Name: PANTHERA TIGRIS Studbook Number: 300
 =====

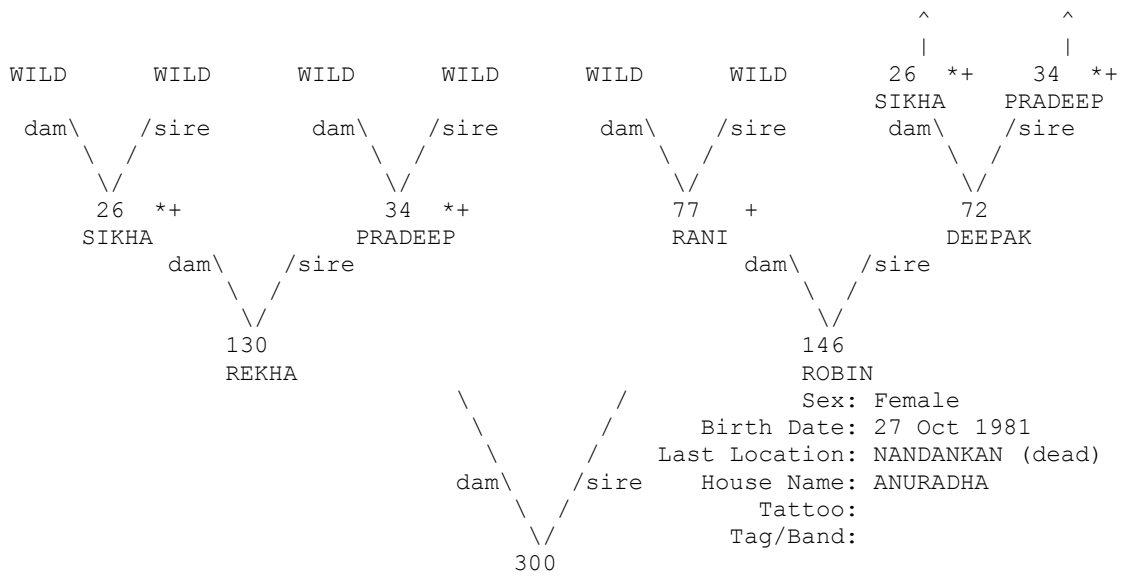

+ Wild-caught... * Appear more than once...
 ^ Pedigree continues beyond top of page...

=====
 Taxon Name: PANTHERA TIGRIS Studbook Number: 301
 =====

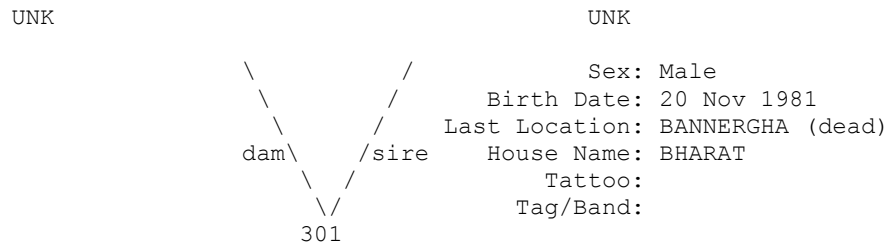

=====
 Taxon Name: PANTHERA TIGRIS Studbook Number: 302
 =====

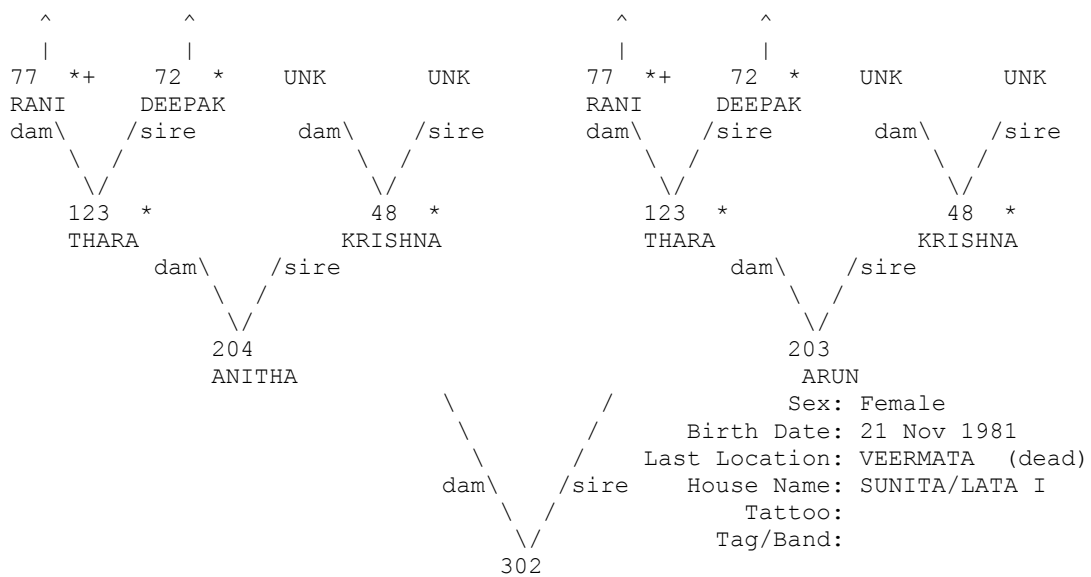

+ Wild-caught... * Appear more than once...
 ^ Pedigree continues beyond top of page...

=====
 Taxon Name: PANTHERA TIGRIS Studbook Number: 310
 =====

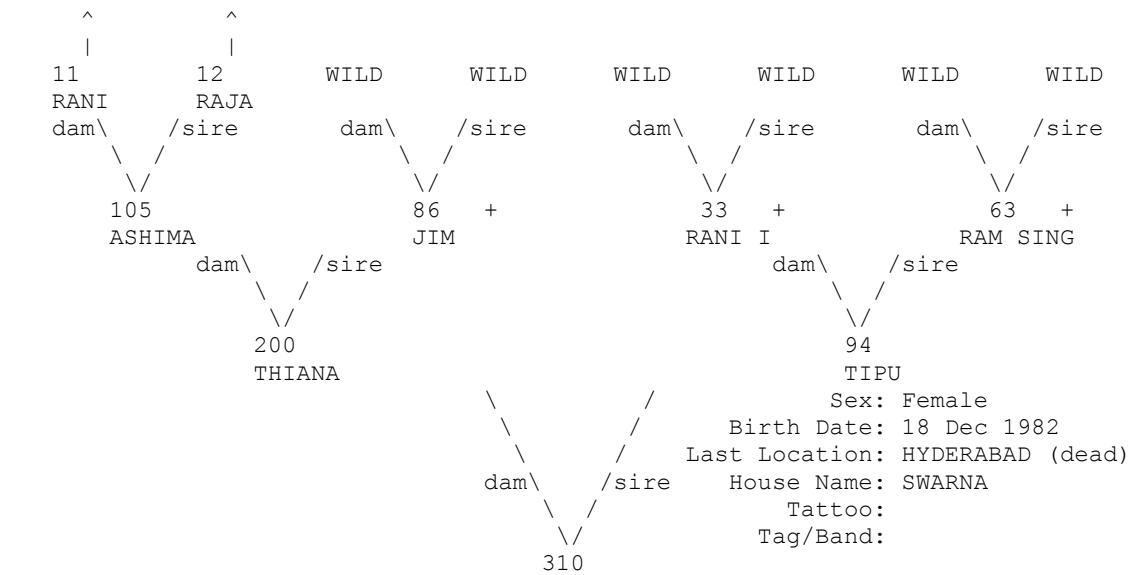

+ Wild-caught... * Appear more than once...
 ^ Pedigree continues beyond top of page...

=====
 Taxon Name: PANTHERA TIGRIS Studbook Number: 311
 =====

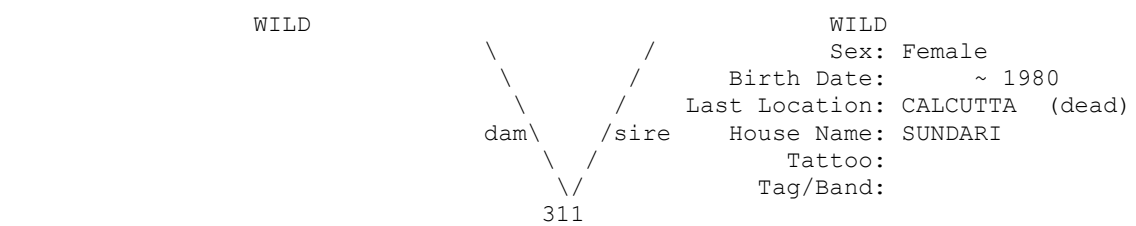

=====
 Taxon Name: PANTHERA TIGRIS Studbook Number: 312
 =====

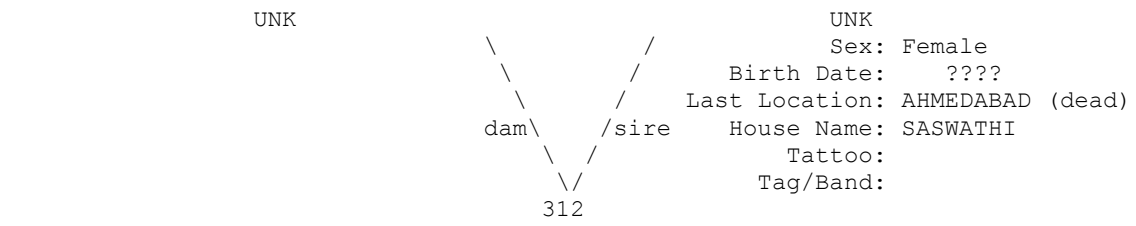

=====
 Taxon Name: PANTHERA TIGRIS Studbook Number: 313
 =====

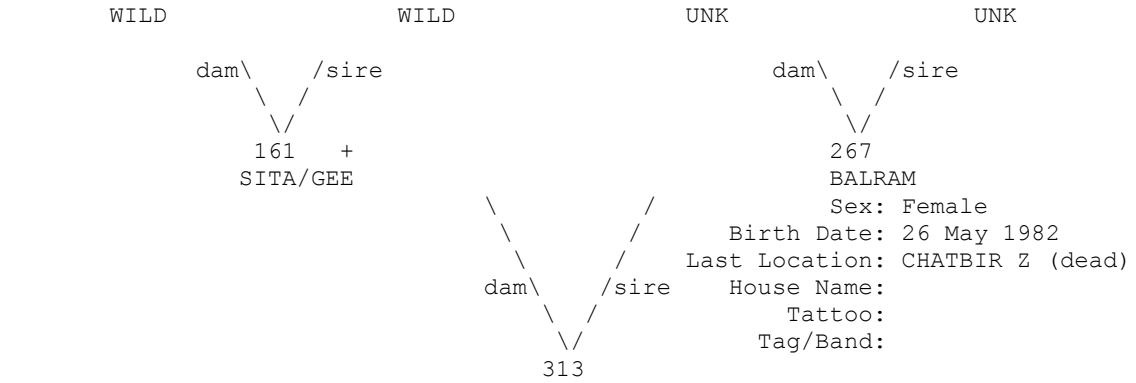

+ Wild-caught...

=====

Taxon Name: PANTHERA TIGRIS Studbook Number: 314

=====

WILD

WILD

UNK

UNK

dam\ /sire

 \ /

 161 +

 SITA/GEE

dam\ /sire

 \ /

 314

dam\ /sire

 \ /

 267

 BALRAM

 Sex: Female

 Birth Date: 26 May 1982

 Last Location: CHATBIR Z (dead)

 House Name:

 Tattoo:

 Tag/Band:

+ Wild-caught...

=====

Taxon Name: PANTHERA TIGRIS Studbook Number: 315

=====

WILD

WILD

dam\ /sire

 \ /

 315

Sex: Male

 Birth Date: ~ May 1982

 Last Location: VANVIHAR (dead)

 House Name: CHIKU

 Tattoo:

 Tag/Band:

=====

Taxon Name: PANTHERA TIGRIS Studbook Number: 316

=====

UNK

UNK

dam\ /sire

 \ /

 316

Sex: Female

 Birth Date: 9 Jul 1982

 Last Location: PESHWE (dead)

 House Name: RUKIMINI

 Tattoo:

 Tag/Band:

=====

Taxon Name: PANTHERA TIGRIS Studbook Number: 317

=====

UNK

UNK

dam\ /sire

 \ /

 317

Sex: Female

 Birth Date: 27 Jul 1982

 Last Location: PESHWE (dead)

 House Name: LAXMI

 Tattoo:

 Tag/Band:

=====
 Taxon Name: PANTHERA TIGRIS Studbook Number: 318
 =====

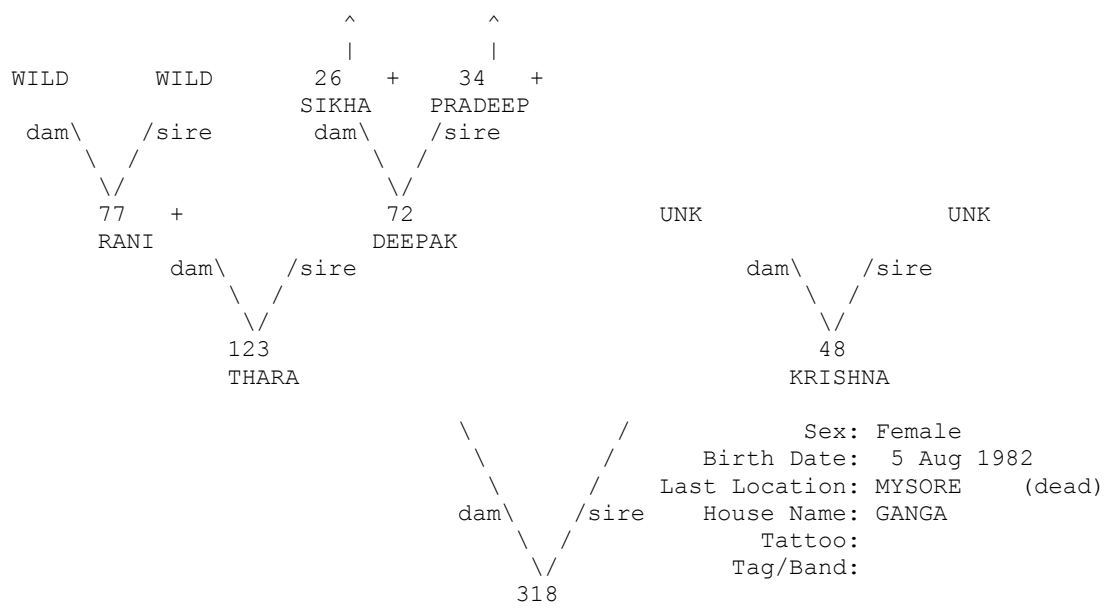

+ Wild-caught...
 ^ Pedigree continues beyond top of page...

=====
 Taxon Name: PANTHERA TIGRIS Studbook Number: 319
 =====

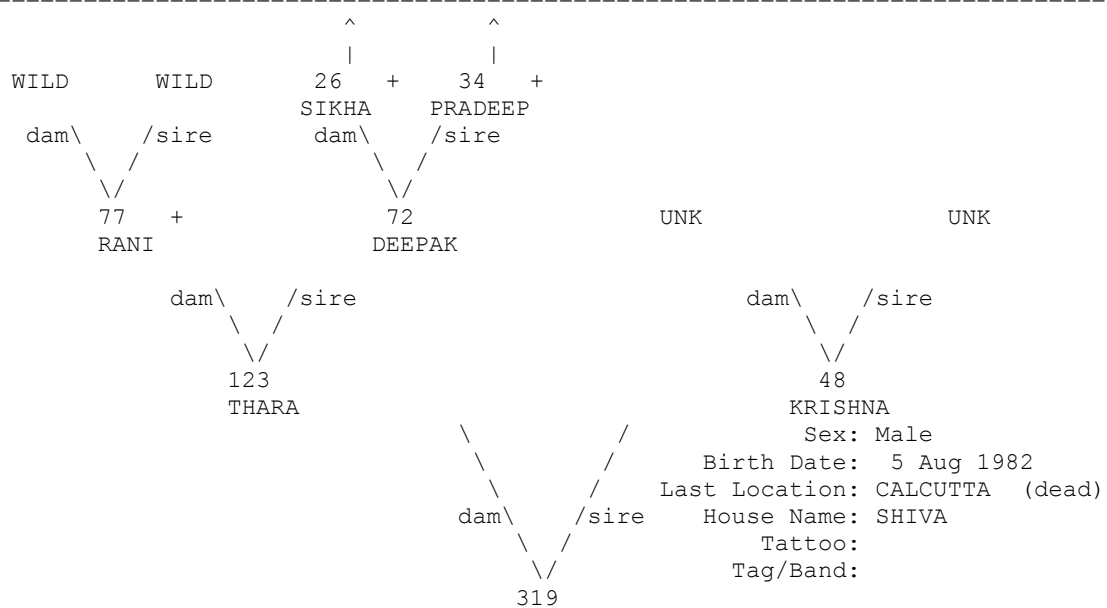

+ Wild-caught...
 ^ Pedigree continues beyond top of page...

=====

Taxon Name: PANTHERA TIGRIS Studbook Number: 323

=====

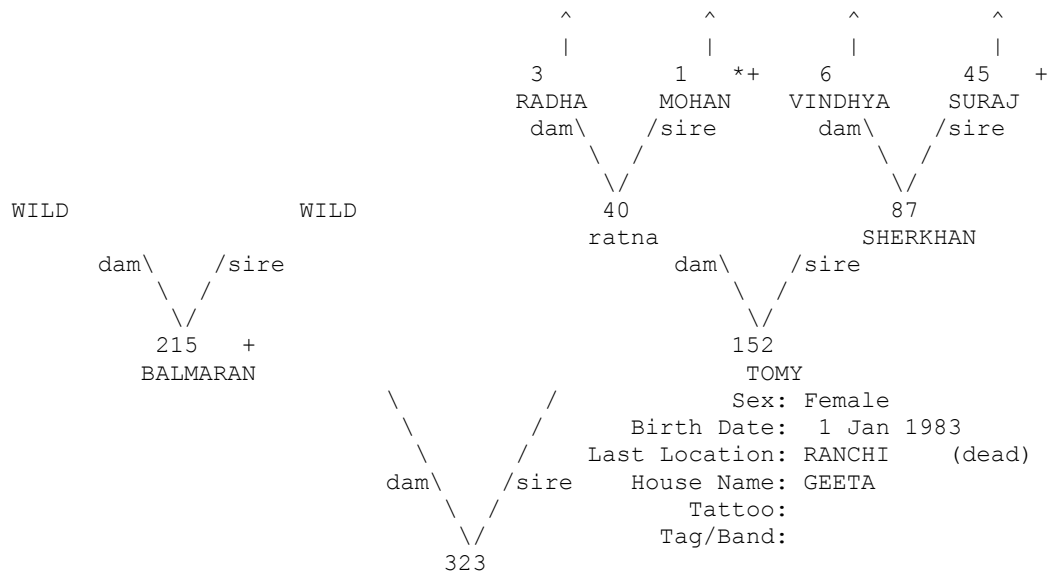

+ Wild-caught... * Appear more than once...
 ^ Pedigree continues beyond top of page...

=====

Taxon Name: PANTHERA TIGRIS Studbook Number: 324

=====

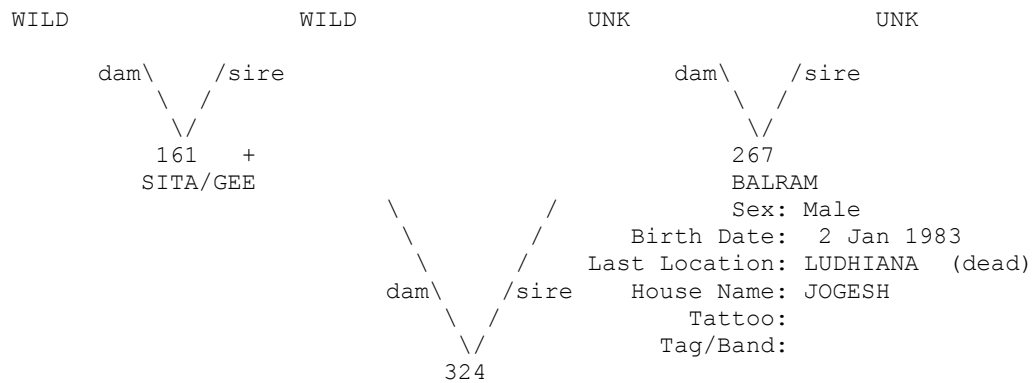

+ Wild-caught...

=====

Taxon Name: PANTHERA TIGRIS Studbook Number: 325

=====

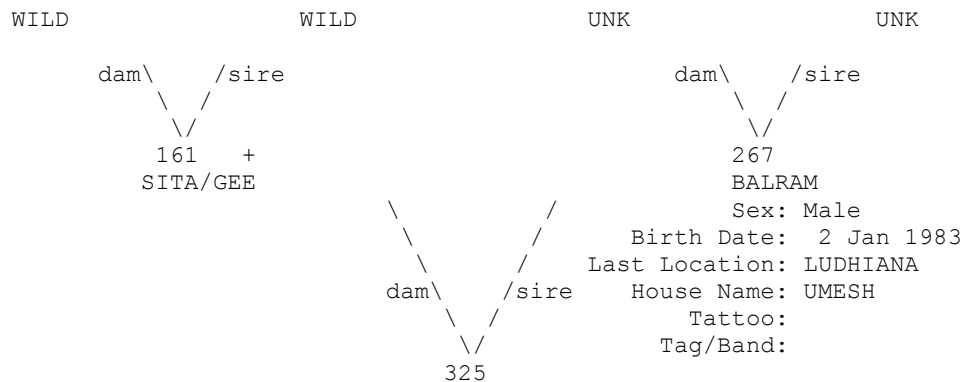

+ Wild-caught...

=====
 Taxon Name: PANTHERA TIGRIS Studbook Number: 326
 =====

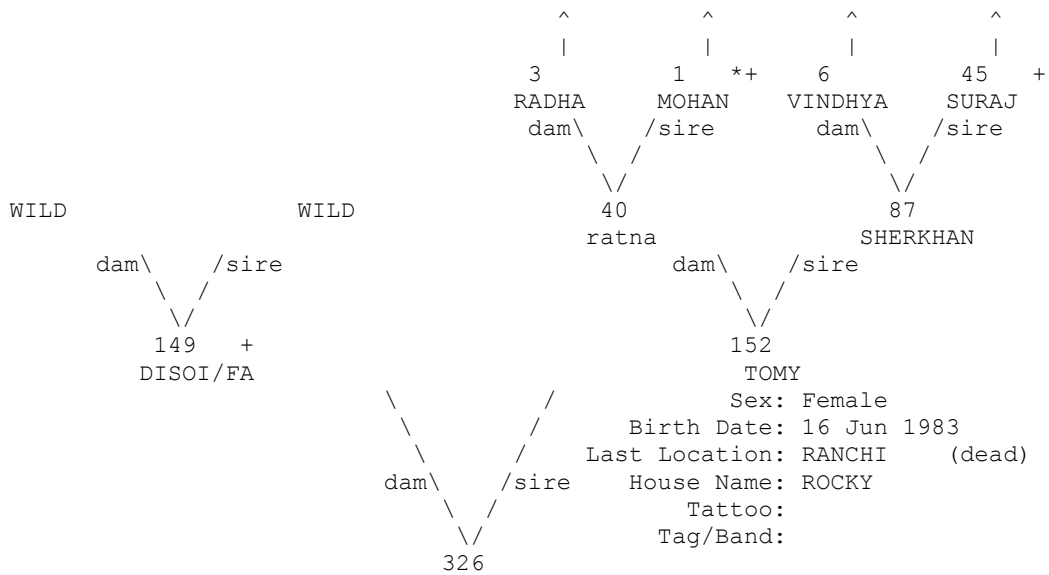

+ Wild-caught... * Appear more than once...
 ^ Pedigree continues beyond top of page...

=====
 Taxon Name: PANTHERA TIGRIS Studbook Number: 327
 =====

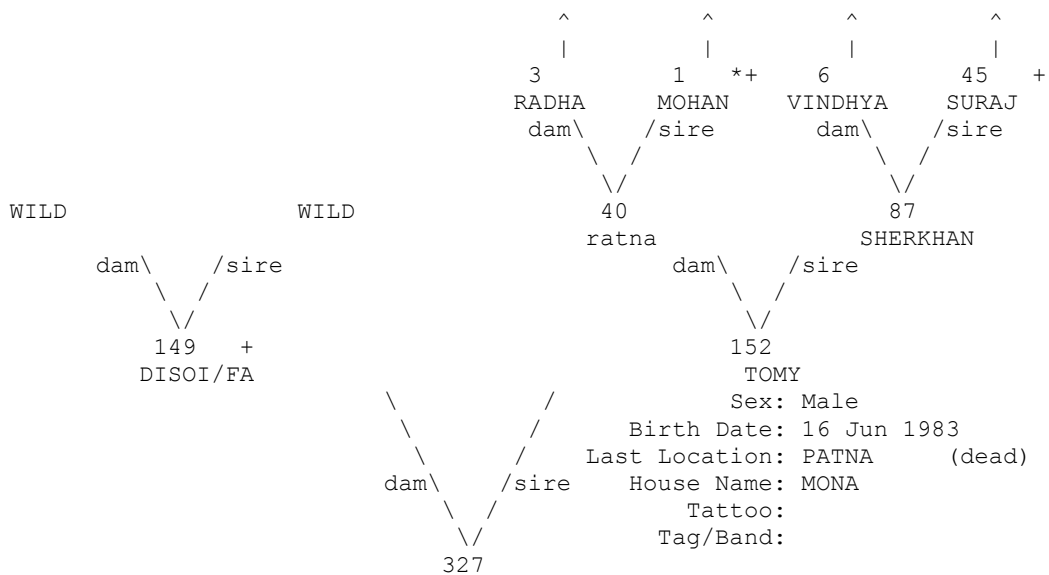

+ Wild-caught... * Appear more than once...
 ^ Pedigree continues beyond top of page...

=====
 Taxon Name: PANTHERA TIGRIS Studbook Number: 328
 =====

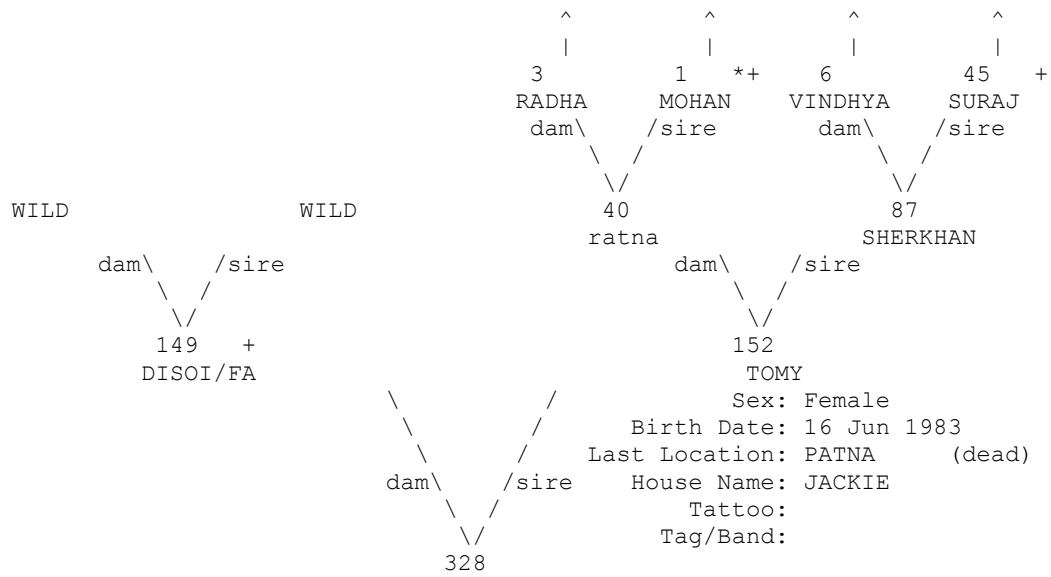

+ Wild-caught... * Appear more than once...
 ^ Pedigree continues beyond top of page...

=====
 Taxon Name: PANTHERA TIGRIS Studbook Number: 329
 =====

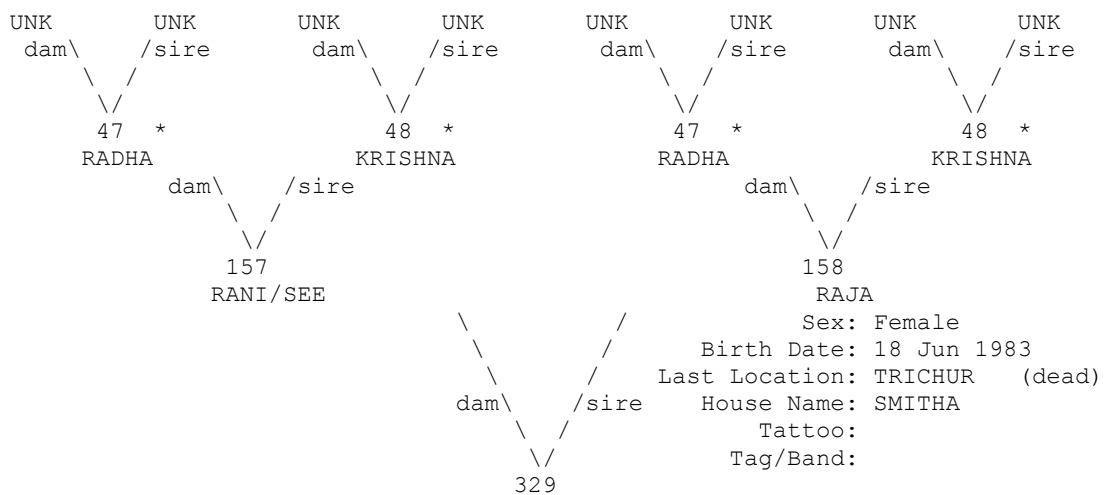

* Appear more than once...

=====
 Taxon Name: PANTHERA TIGRIS Studbook Number: 330
 =====

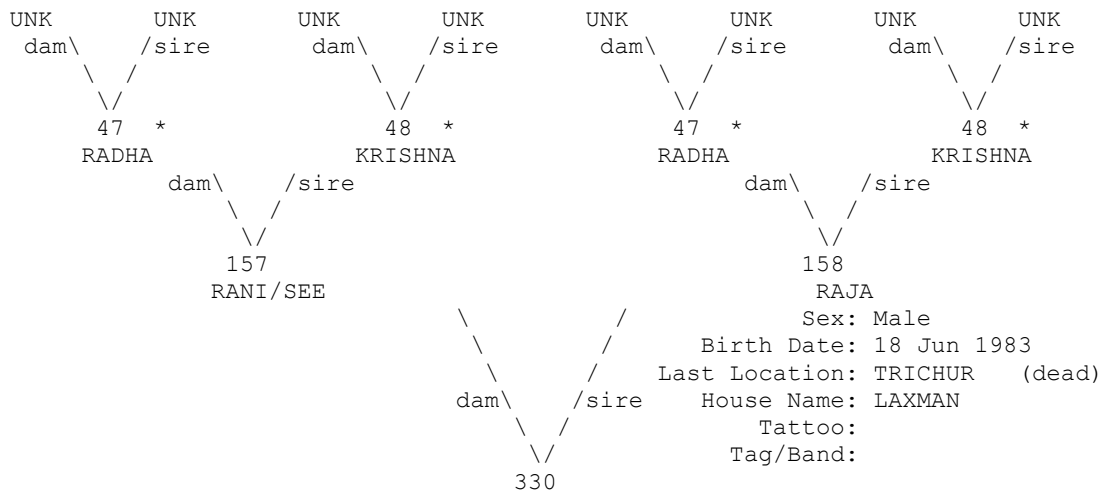

* Appear more than once...

=====
 Taxon Name: PANTHERA TIGRIS Studbook Number: 331
 =====

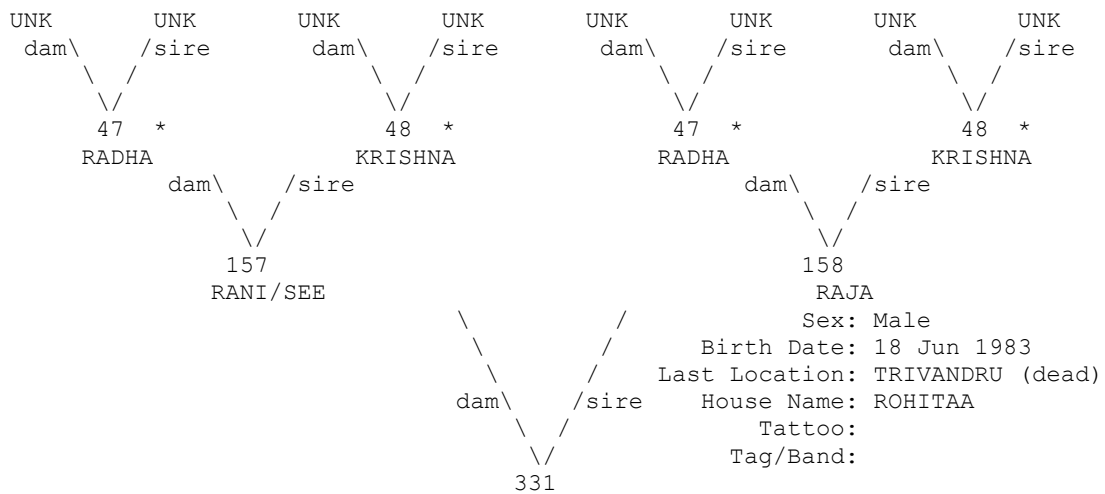

* Appear more than once...

=====

Taxon Name: PANTHERA TIGRIS Studbook Number: 337

=====

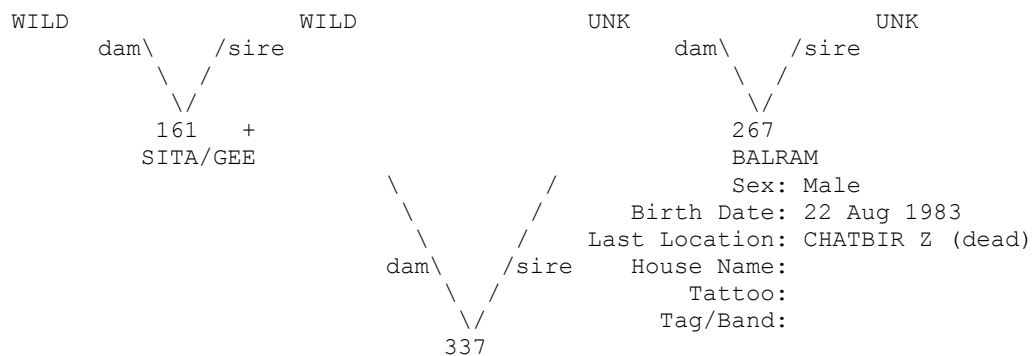

+ Wild-caught...

=====

Taxon Name: PANTHERA TIGRIS Studbook Number: 338

=====

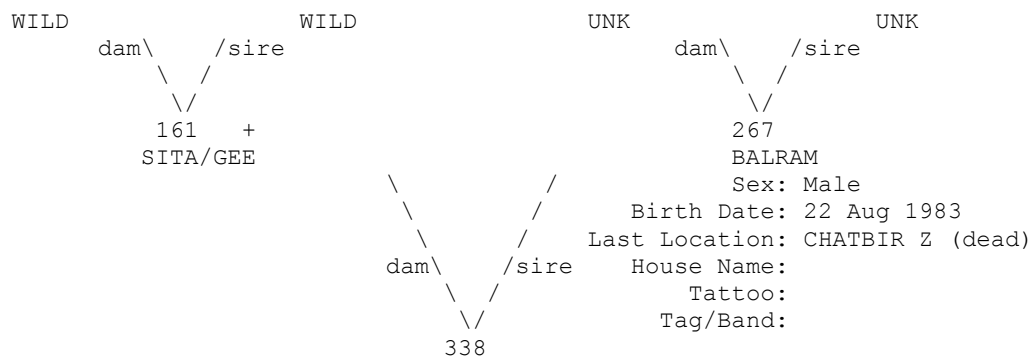

+ Wild-caught...

=====

Taxon Name: PANTHERA TIGRIS Studbook Number: 339

=====

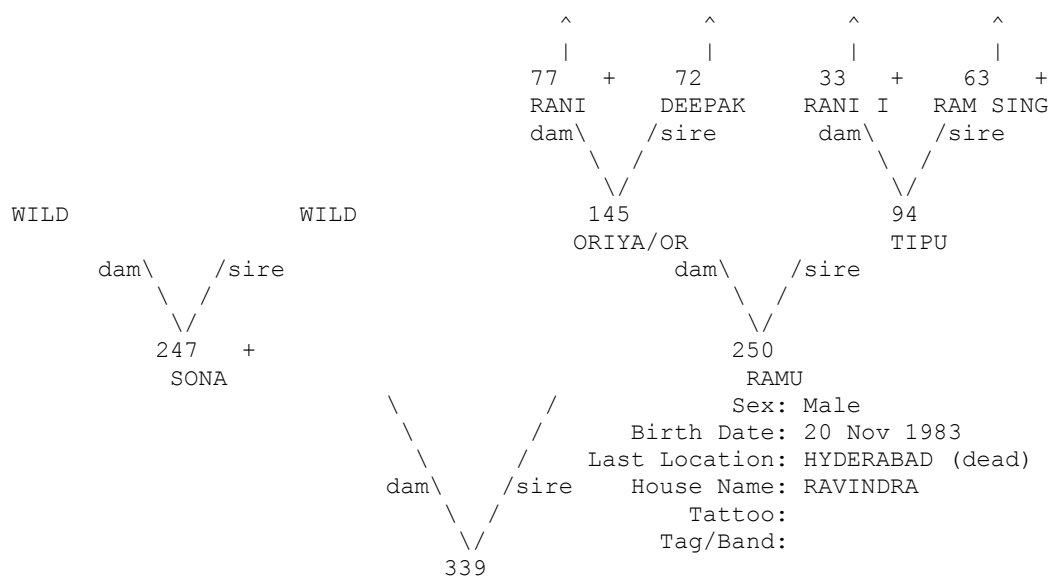

+ Wild-caught...

^ Pedigree continues beyond top of page...

=====
 Taxon Name: PANTHERA TIGRIS Studbook Number: 340
 =====

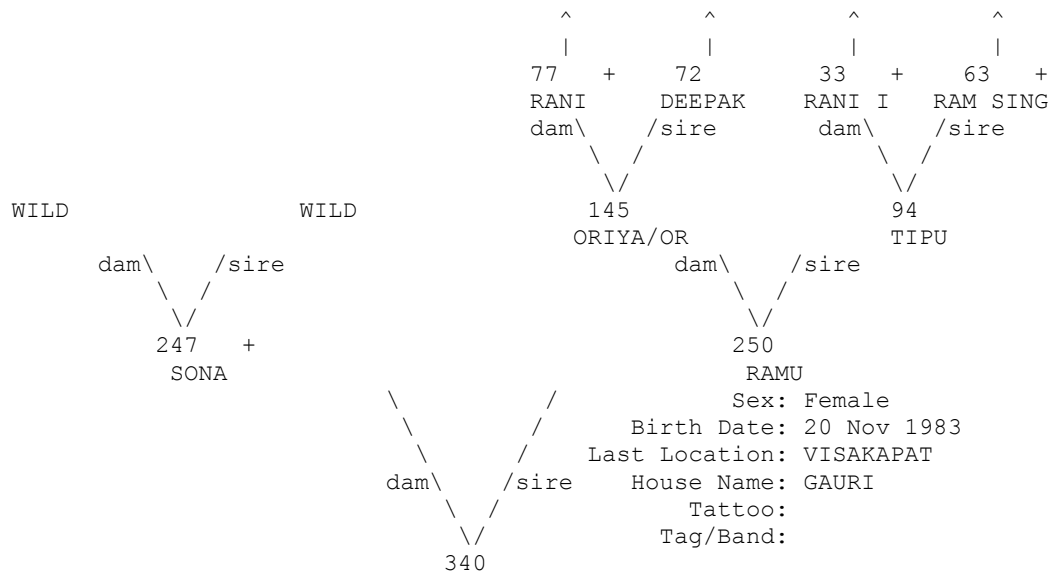

+ Wild-caught...
 ^ Pedigree continues beyond top of page...

=====
 Taxon Name: PANTHERA TIGRIS Studbook Number: 341
 =====

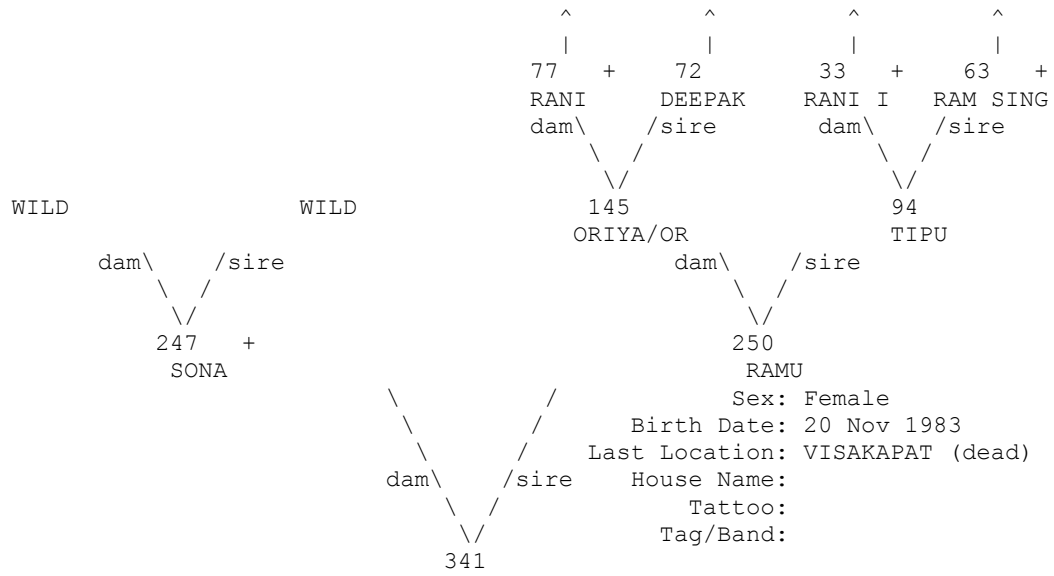

+ Wild-caught...
 ^ Pedigree continues beyond top of page...

=====
 Taxon Name: PANTHERA TIGRIS Studbook Number: 344
 =====

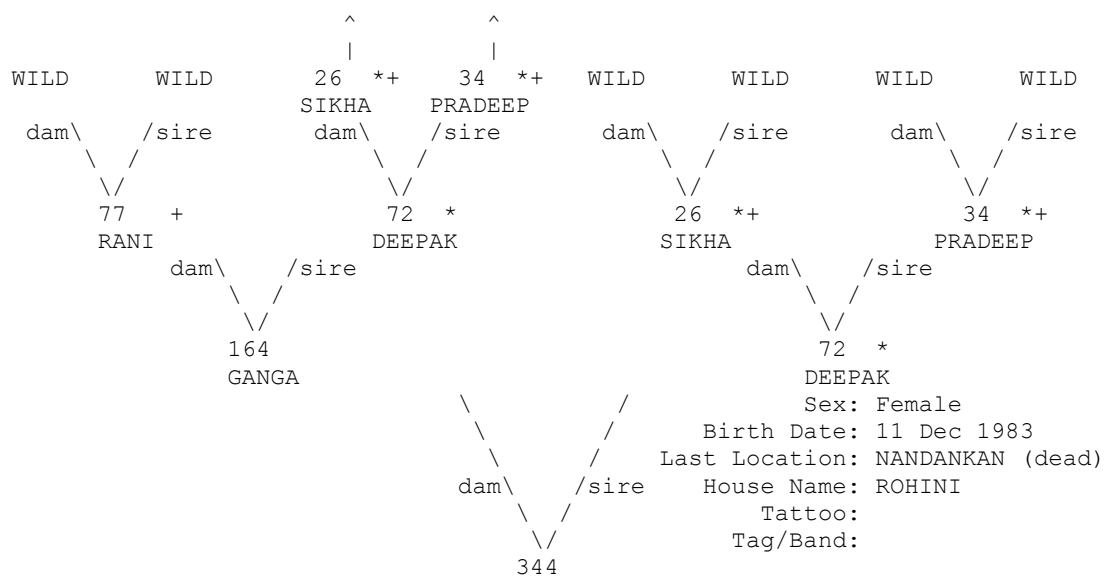

+ Wild-caught... * Appear more than once...
 ^ Pedigree continues beyond top of page...

=====
 Taxon Name: PANTHERA TIGRIS Studbook Number: 345
 =====

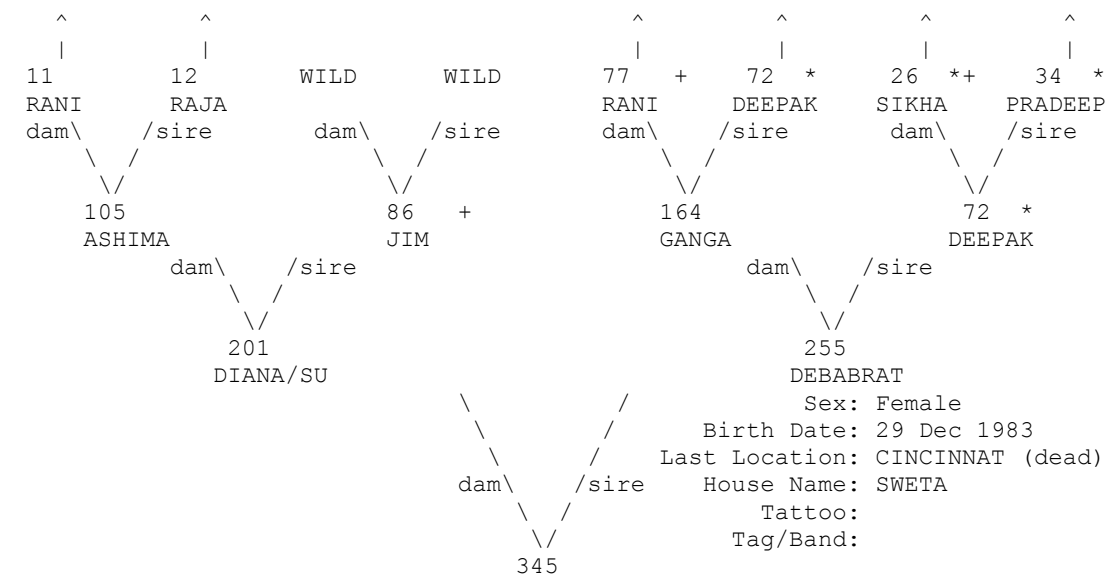

+ Wild-caught... * Appear more than once...
 ^ Pedigree continues beyond top of page...

=====
 Taxon Name: PANTHERA TIGRIS Studbook Number: 346
 =====

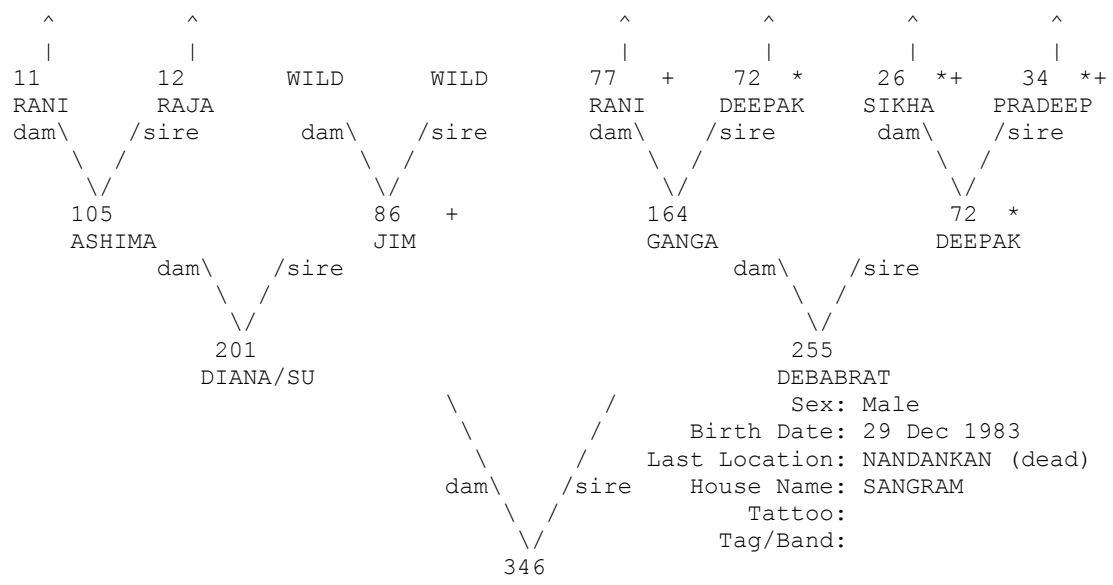

+ Wild-caught... * Appear more than once...
 ^ Pedigree continues beyond top of page...

=====
 Taxon Name: PANTHERA TIGRIS Studbook Number: 347
 =====

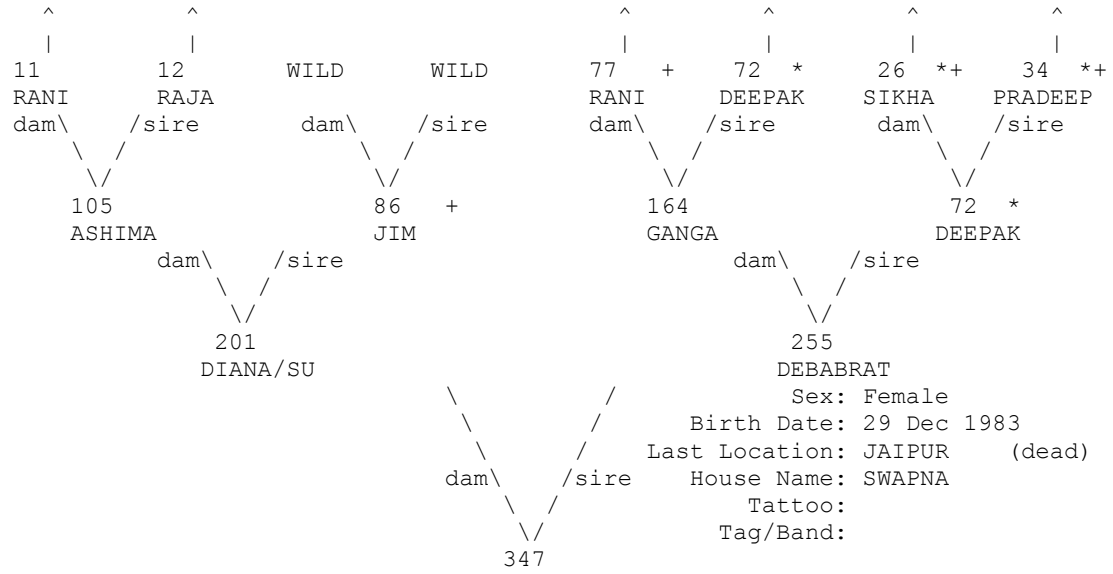

+ Wild-caught... * Appear more than once...
 ^ Pedigree continues beyond top of page...

=====
 Taxon Name: PANTHERA TIGRIS Studbook Number: 348
 =====

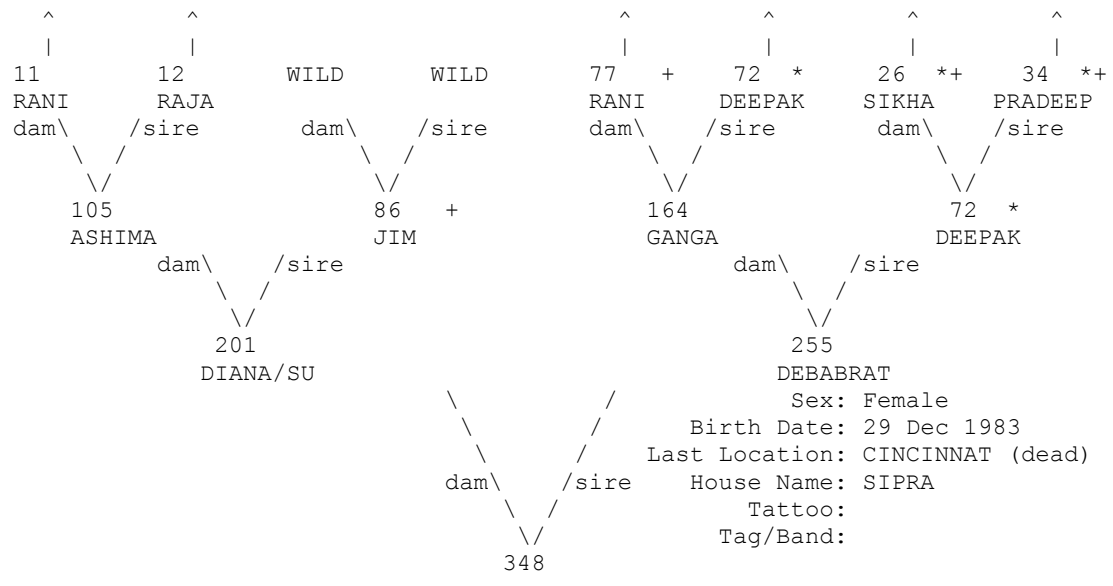

+ Wild-caught... * Appear more than once...
 ^ Pedigree continues beyond top of page...

=====
 Taxon Name: PANTHERA TIGRIS Studbook Number: 349
 =====

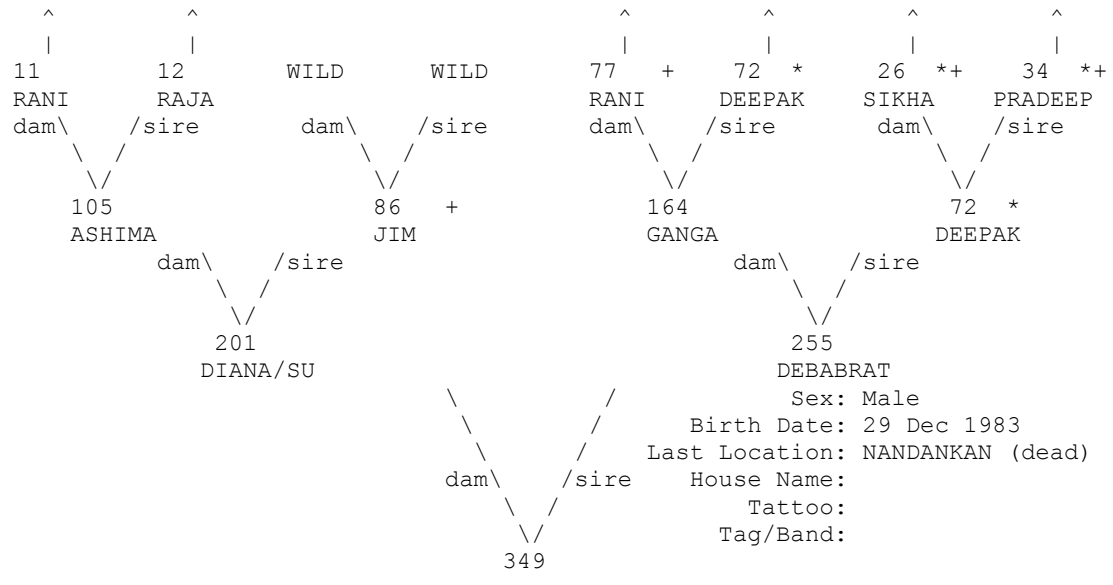

+ Wild-caught... * Appear more than once...
 ^ Pedigree continues beyond top of page...

=====
 Taxon Name: PANTHERA TIGRIS Studbook Number: 350
 =====

WILD

WILD

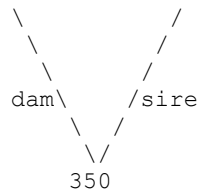

Sex: Female
 Birth Date: ~ 1964
 Last Location: ASSAM (dead)
 House Name: SIELADEVI
 Tattoo:
 Tag/Band:

=====
 Taxon Name: PANTHERA TIGRIS Studbook Number: 351
 =====

WILD

WILD

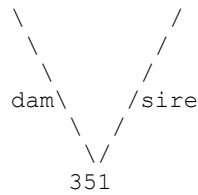

Sex: Male
 Birth Date: ????
 Last Location: KANPUR (dead)
 House Name: SHEROO
 Tattoo:
 Tag/Band:

=====
 Taxon Name: PANTHERA TIGRIS Studbook Number: 352
 =====

WILD

WILD

WILD

WILD

WILD

WILD

^

26

++

^

34

++

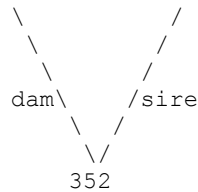
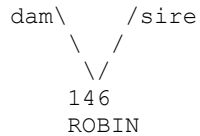
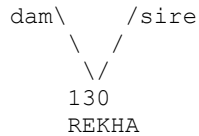
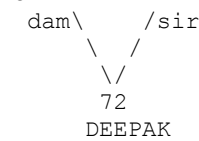
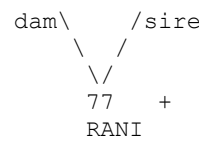
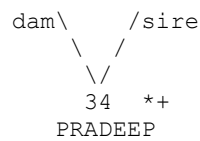
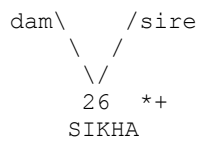

Sex: Female
 Birth Date: 8 Mar 1984
 Last Location: VADODARA (dead)
 House Name: BANANI
 Tattoo:
 Tag/Band:

+ Wild-caught... * Appear more than once...
 ^ Pedigree continues beyond top of page...

=====
 Taxon Name: PANTHERA TIGRIS Studbook Number: 353
 =====

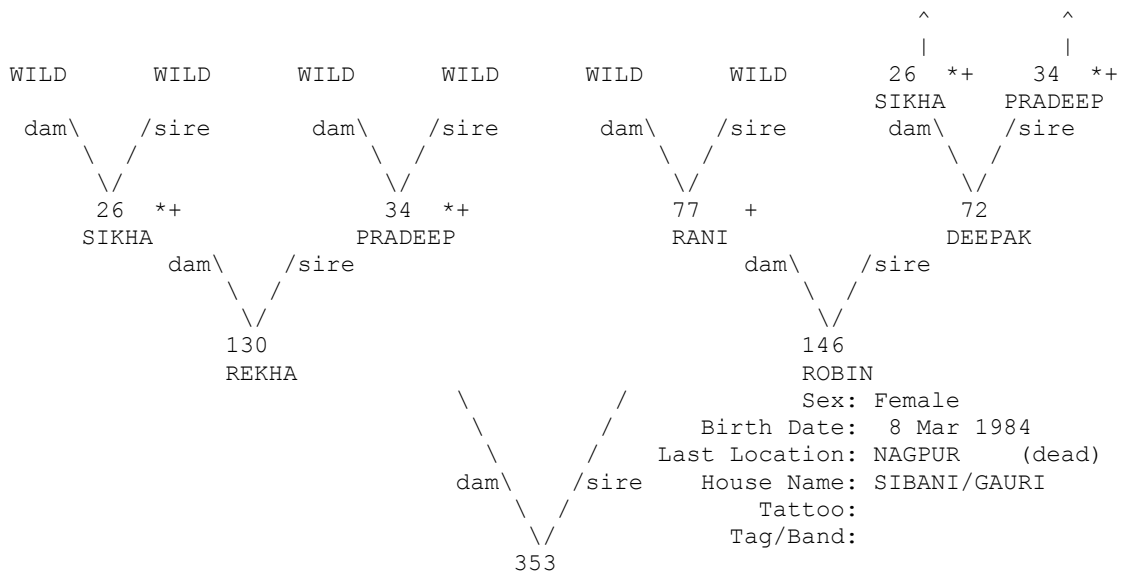

+ Wild-caught... * Appear more than once...
 ^ Pedigree continues beyond top of page...

=====
 Taxon Name: PANTHERA TIGRIS Studbook Number: 354
 =====

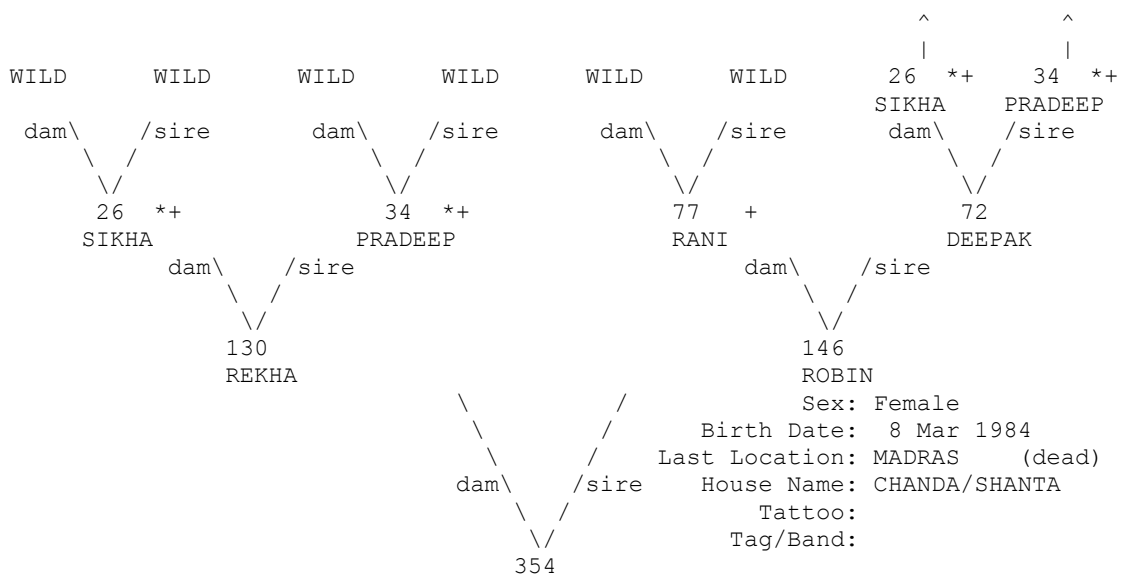

+ Wild-caught... * Appear more than once...
 ^ Pedigree continues beyond top of page...

=====
 Taxon Name: PANTHERA TIGRIS Studbook Number: 355
 =====

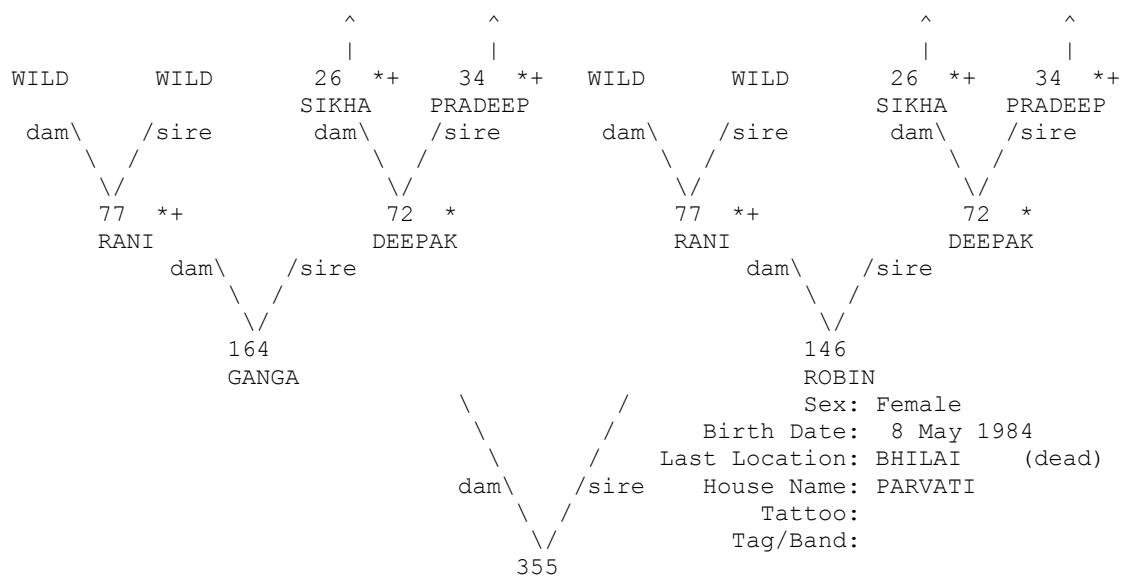

+ Wild-caught... * Appear more than once...
 ^ Pedigree continues beyond top of page...

=====
 Taxon Name: PANTHERA TIGRIS Studbook Number: 356
 =====

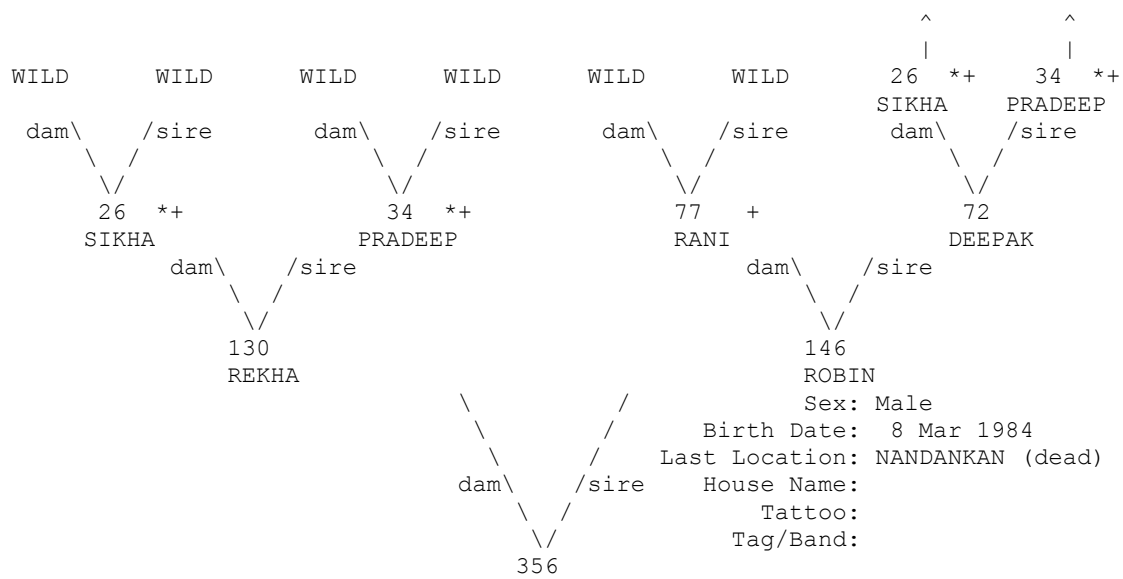

+ Wild-caught... * Appear more than once...
 ^ Pedigree continues beyond top of page...

=====
 Taxon Name: PANTHERA TIGRIS Studbook Number: 357
 =====

UNK

UNK

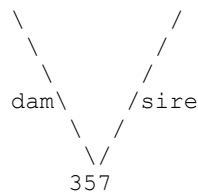

Sex: Female
 Birth Date: 8 Mar 1984
 Last Location: VADODARA (dead)
 House Name: DORA
 Tattoo:
 Tag/Band:

=====
 Taxon Name: PANTHERA TIGRIS Studbook Number: 358
 =====

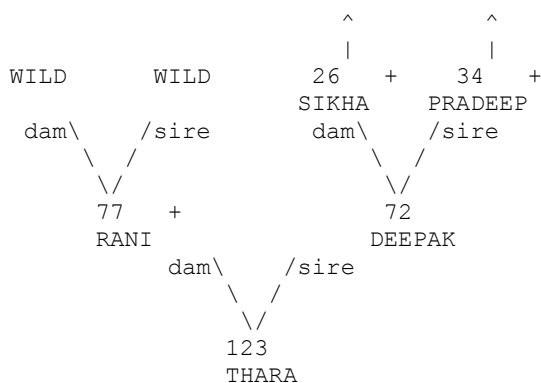

UNK

UNK

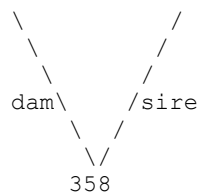

Sex: Male
 Birth Date: 19 Apr 1984
 Last Location: AURANGABA (dead)
 House Name: DORA
 Tattoo:
 Tag/Band:

+ Wild-caught...
 ^ Pedigree continues beyond top of page...

=====
 Taxon Name: PANTHERA TIGRIS Studbook Number: 359
 =====

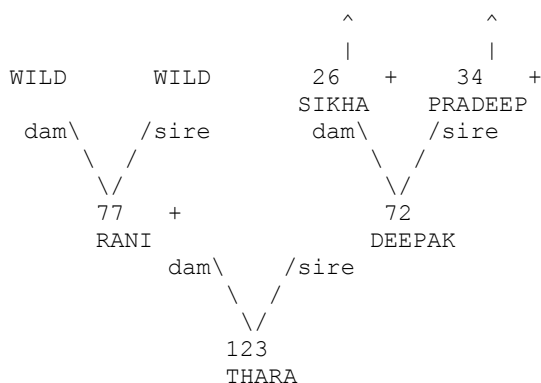

UNK

UNK

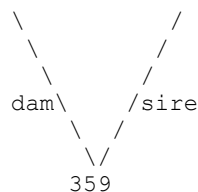

Sex: Female
 Birth Date: 19 Apr 1984
 Last Location: TRIVANDRU (dead)
 House Name: MEERA
 Tattoo:
 Tag/Band:

+ Wild-caught...
 ^ Pedigree continues beyond top of page...

=====
 Taxon Name: PANTHERA TIGRIS Studbook Number: 360
 =====

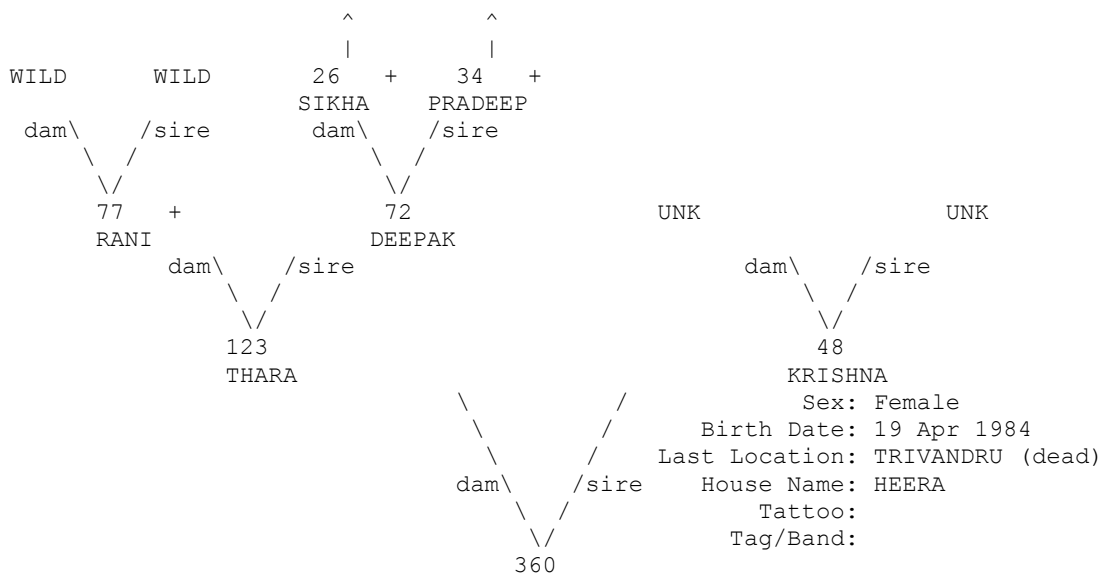

+ Wild-caught...
 ^ Pedigree continues beyond top of page...

=====
 Taxon Name: PANTHERA TIGRIS Studbook Number: 361
 =====

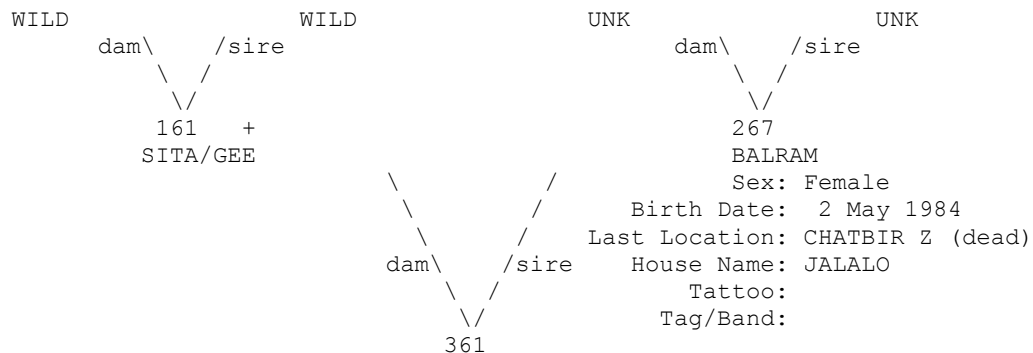

+ Wild-caught...

=====
 Taxon Name: PANTHERA TIGRIS Studbook Number: 362
 =====

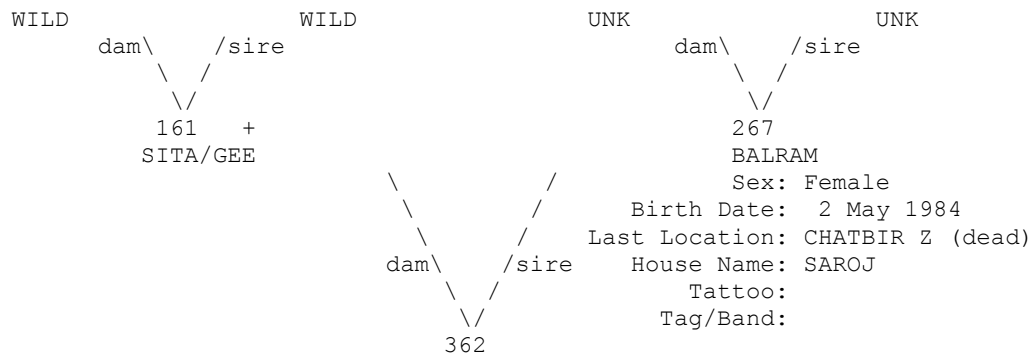

+ Wild-caught...

=====
 Taxon Name: PANTHERA TIGRIS Studbook Number: 366
 =====

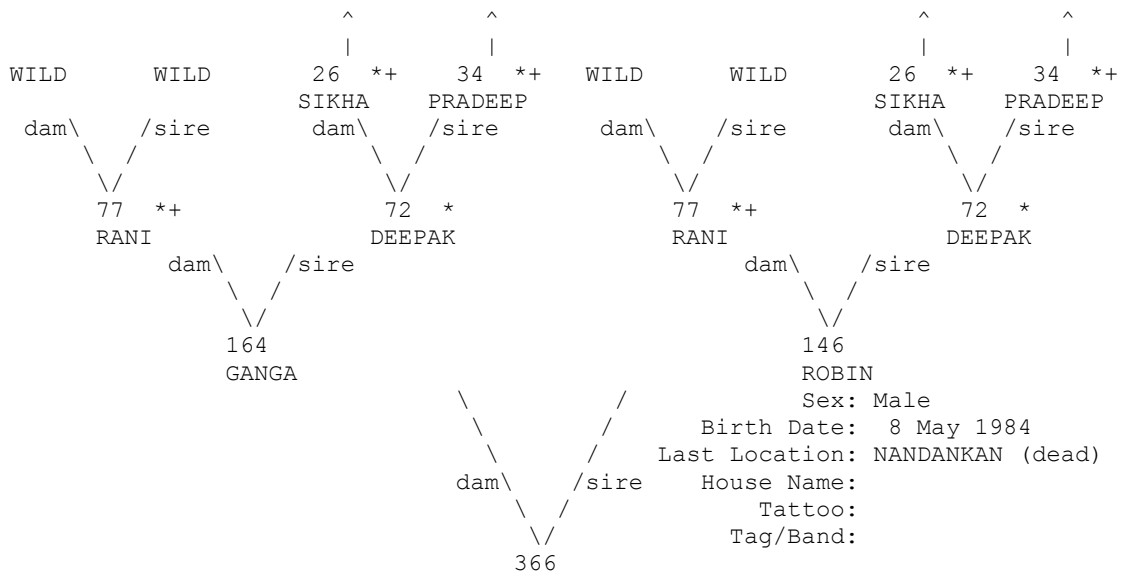

+ Wild-caught... * Appear more than once...
 ^ Pedigree continues beyond top of page...

=====
 Taxon Name: PANTHERA TIGRIS Studbook Number: 367
 =====

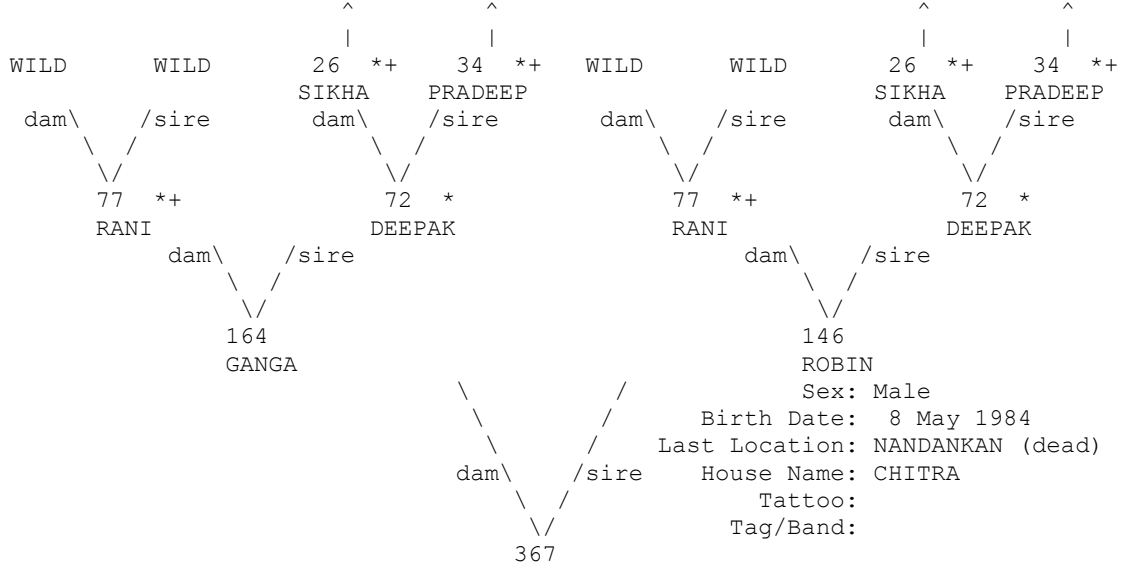

+ Wild-caught... * Appear more than once...
 ^ Pedigree continues beyond top of page...

=====
Taxon Name: PANTHERA TIGRIS Studbook Number: 368
=====

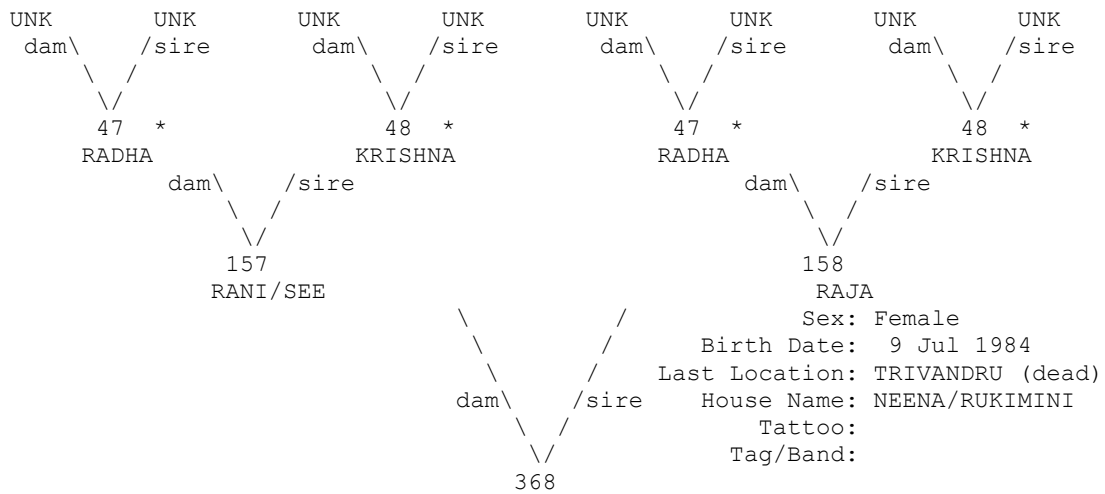

* Appear more than once...

=====
Taxon Name: PANTHERA TIGRIS Studbook Number: 369
=====

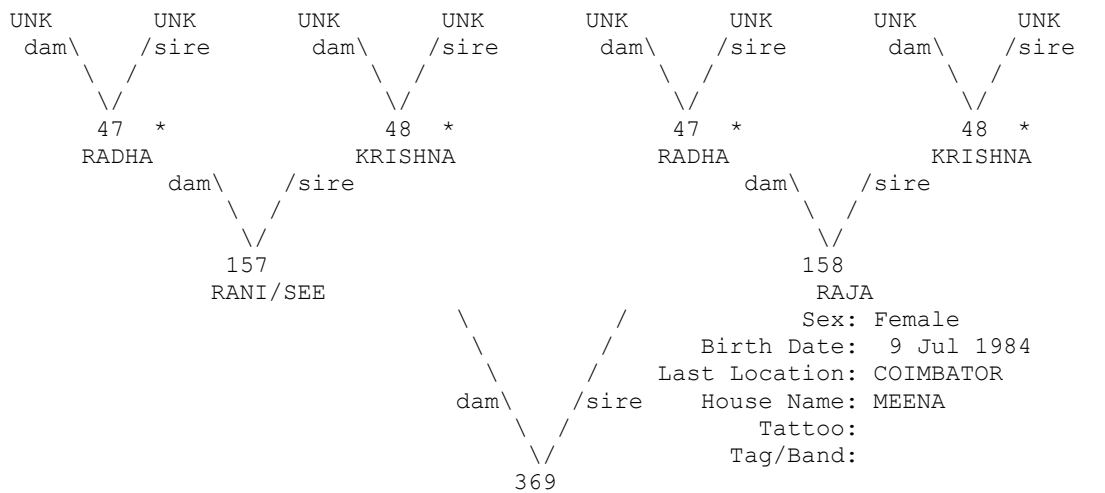

* Appear more than once...

=====
Taxon Name: PANTHERA TIGRIS Studbook Number: 370
=====

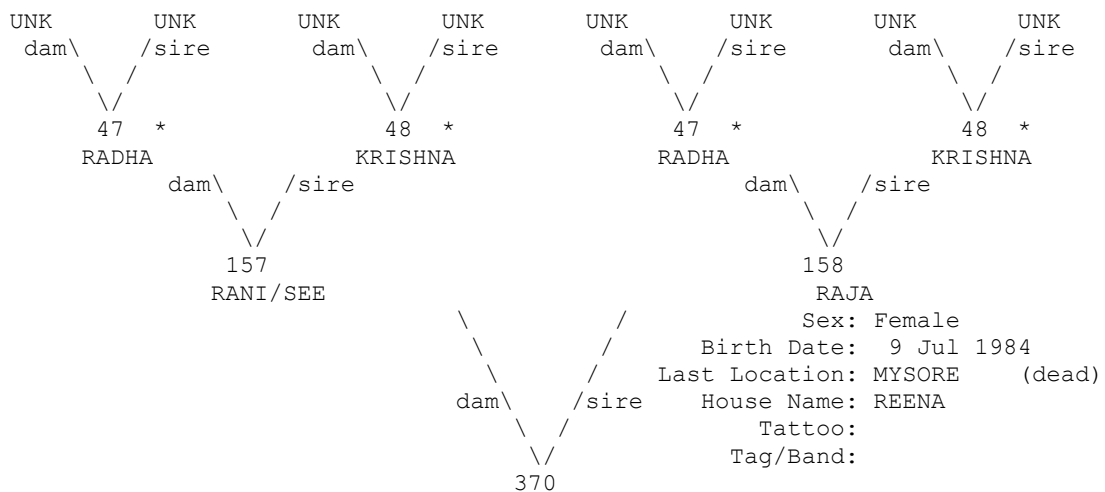

* Appear more than once...

=====
 Taxon Name: PANTHERA TIGRIS Studbook Number: 371
 =====

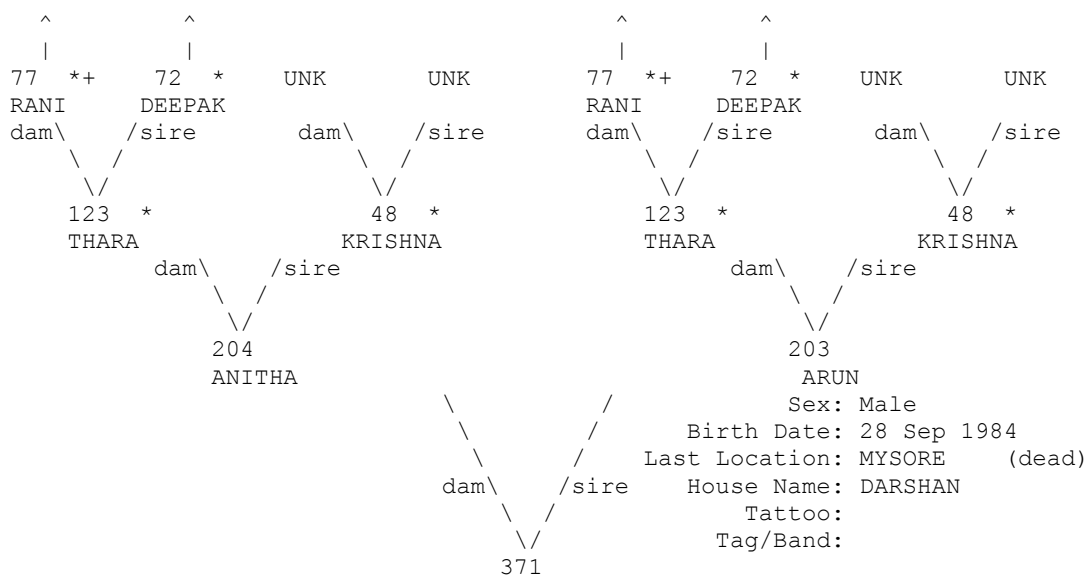

+ Wild-caught... * Appear more than once...
 ^ Pedigree continues beyond top of page...

=====
 Taxon Name: PANTHERA TIGRIS Studbook Number: 372
 =====

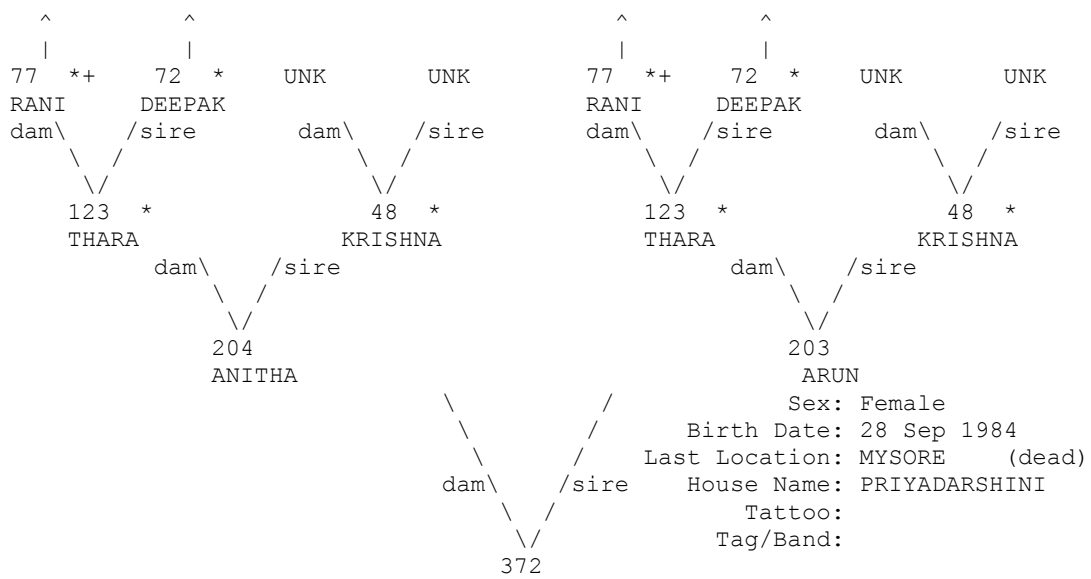

+ Wild-caught... * Appear more than once...
 ^ Pedigree continues beyond top of page...

=====
 Taxon Name: PANTHERA TIGRIS Studbook Number: 373
 =====

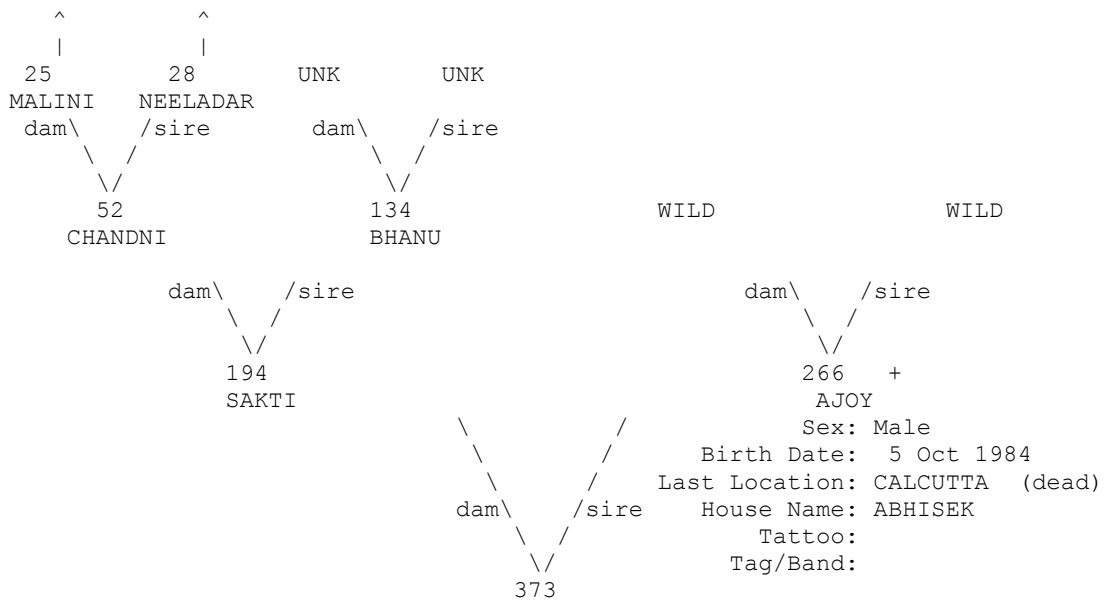

+ Wild-caught... * Appear more than once...
 ^ Pedigree continues beyond top of page...

=====
 Taxon Name: PANTHERA TIGRIS Studbook Number: 374
 =====

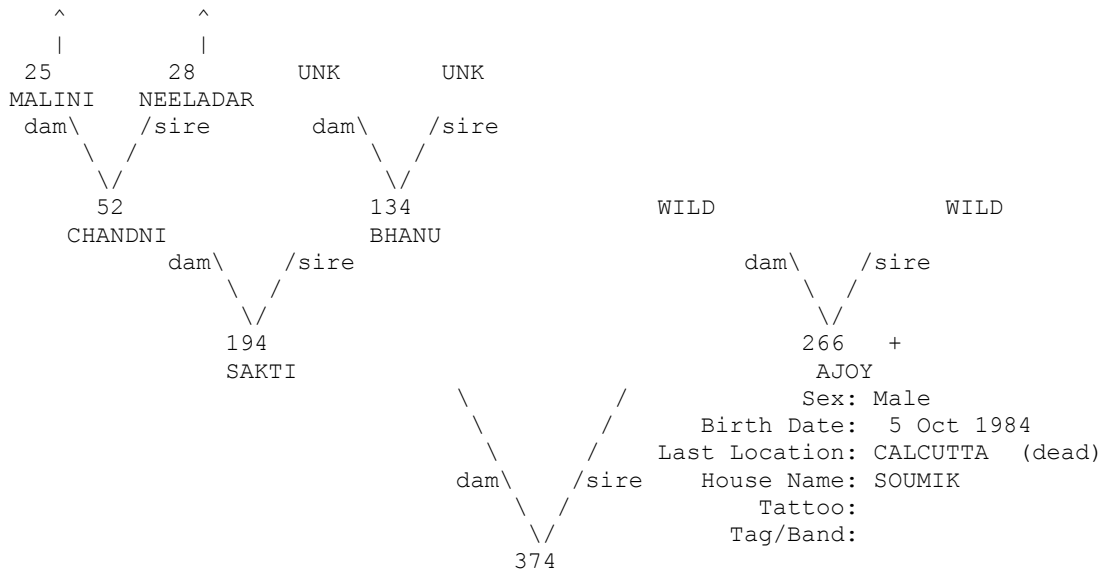

+ Wild-caught... * Appear more than once...
 ^ Pedigree continues beyond top of page...

=====
 Taxon Name: PANTHERA TIGRIS Studbook Number: 375
 =====

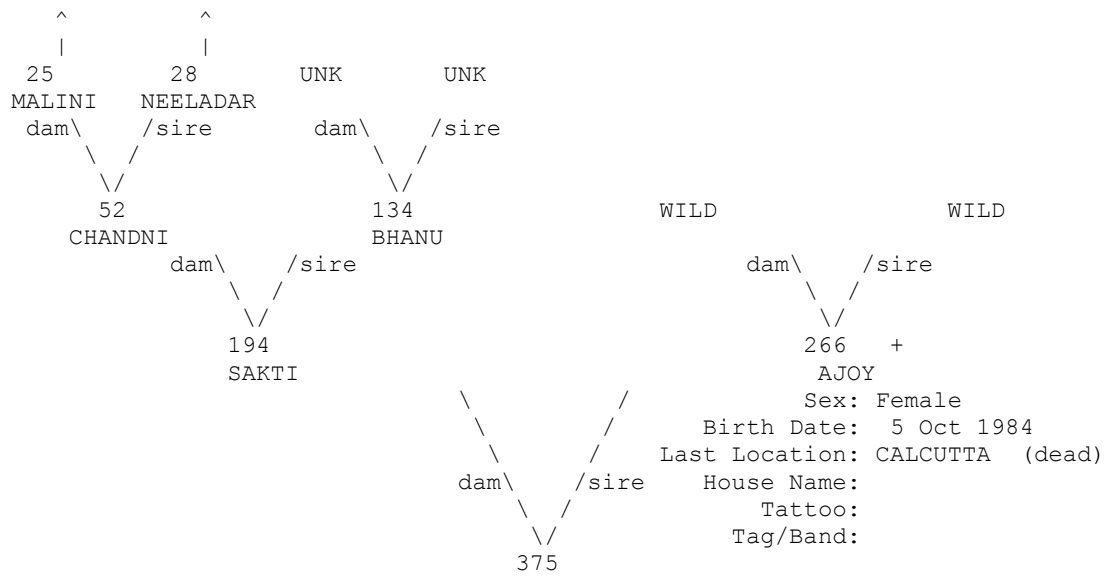

+ Wild-caught... * Appear more than once...
 ^ Pedigree continues beyond top of page...

=====
 Taxon Name: PANTHERA TIGRIS Studbook Number: 376
 =====

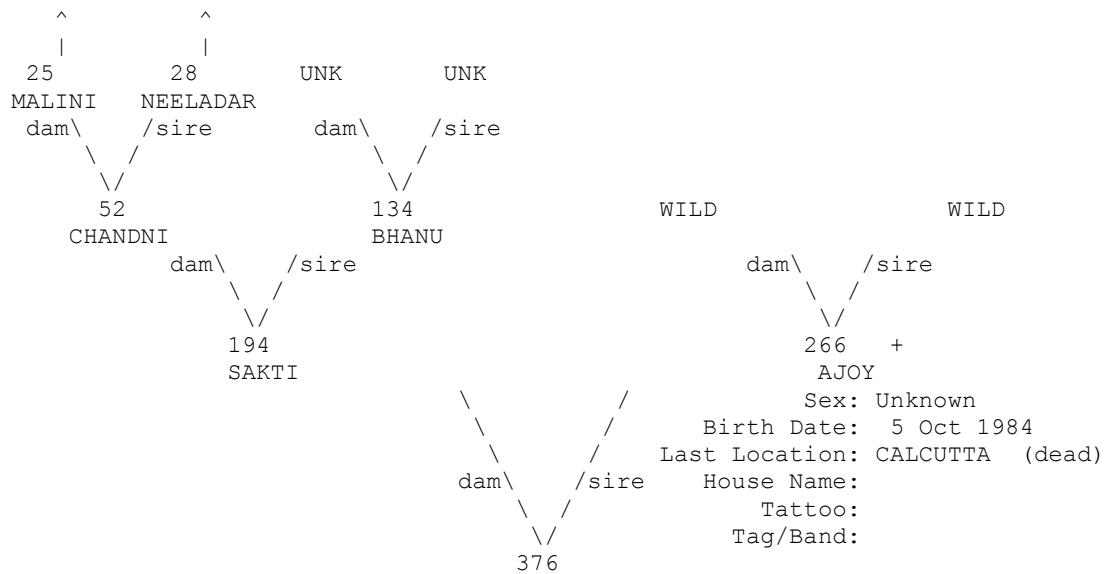

+ Wild-caught... * Appear more than once...
 ^ Pedigree continues beyond top of page...

```

=====
Taxon Name: PANTHERA TIGRIS                      Studbook Number: 377
=====
WILD                                              WILD
                                                Sex: Male
                                                Birth Date: ~ 1981
                                                Last Location: HYDERABAD (dead)
                                                House Name: ATMARAM
                                                Tattoo:
                                                Tag/Band:
dam\      /sire
 \      /
  \    /
   \  /
    \ /
     V
    377

```

```

=====
Taxon Name: PANTHERA TIGRIS                      Studbook Number: 378
=====
WILD                                              WILD
                                                Sex: Male
                                                Birth Date: ~ 1982
                                                Last Location: ASSAM (dead)
                                                House Name: SHANKAR II
                                                Tattoo:
                                                Tag/Band:
dam\      /sire
 \      /
  \    /
   \  /
    \ /
     V
    378

```

```

=====
Taxon Name: PANTHERA TIGRIS                      Studbook Number: 379
=====
WILD      WILD      26  *+      34  *+      WILD      WILD      WILD      WILD
dam\      /sire      dam\      /sire      dam\      /sire      dam\      /sire
 \      /              \      /              \      /              \      /
  \    /              \    /              \    /              \    /
   \  /              \  /              \  /              \  /
    \ /              \ /              \ /              \ /
     V              V              V              V
    77  +          72  *          26  *+          34  *+
    RANI          DEEPAK          SIKHA          PRADEEP
      dam\      /sire      dam\      /sire
       \      /              \      /
        \    /              \    /
         \  /              \  /
          \ /              \ /
           V              V
          164          72  *
          GANGA          DEEPAK
                        Sex: Male
                        Birth Date: 21 Apr 1985
                        Last Location: SHOLAPUR (dead)
                        House Name: KRISHNA
                        Tattoo:
                        Tag/Band:
dam\      /sire
 \      /
  \    /
   \  /
    \ /
     V
    379

```

+ Wild-caught... * Appear more than once...
^ Pedigree continues beyond top of page...

=====
 Taxon Name: PANTHERA TIGRIS Studbook Number: 380
 =====

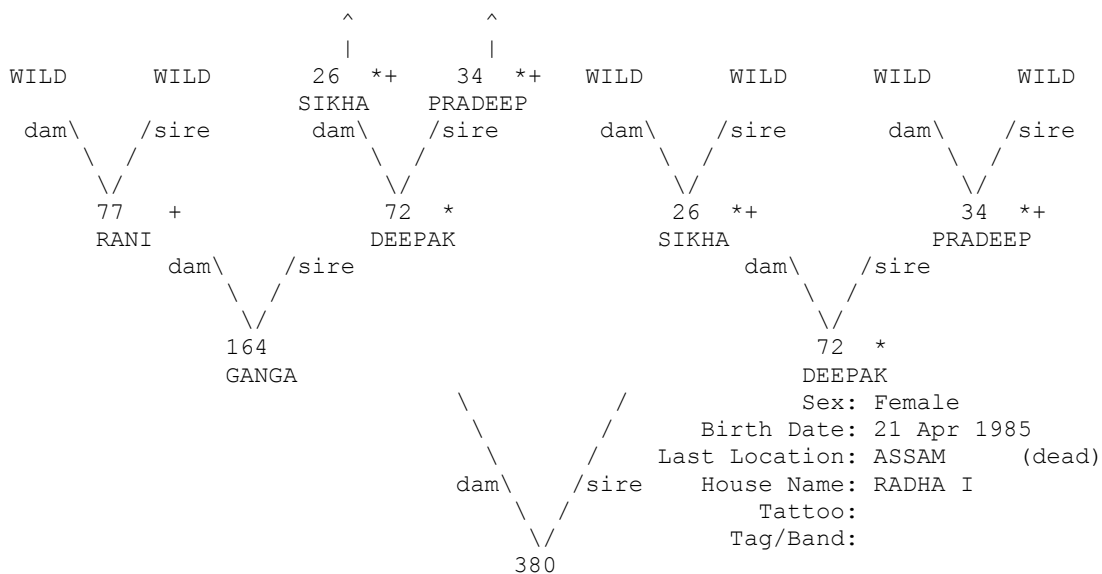

+ Wild-caught... * Appear more than once...
 ^ Pedigree continues beyond top of page...

=====
 Taxon Name: PANTHERA TIGRIS Studbook Number: 381
 =====

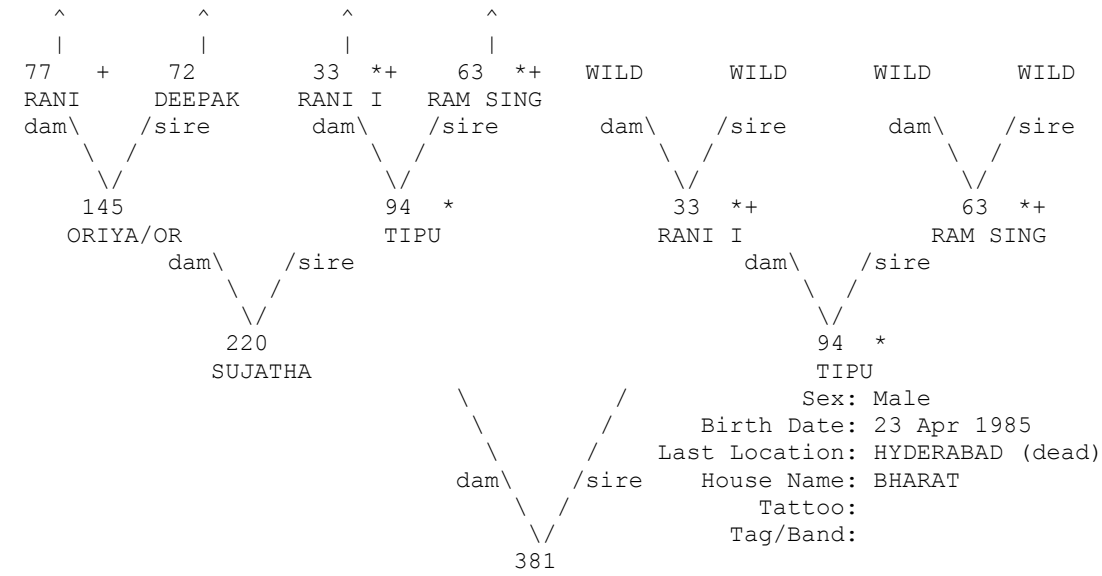

+ Wild-caught... * Appear more than once...
 ^ Pedigree continues beyond top of page...

=====
 Taxon Name: PANTHERA TIGRIS Studbook Number: 382
 =====

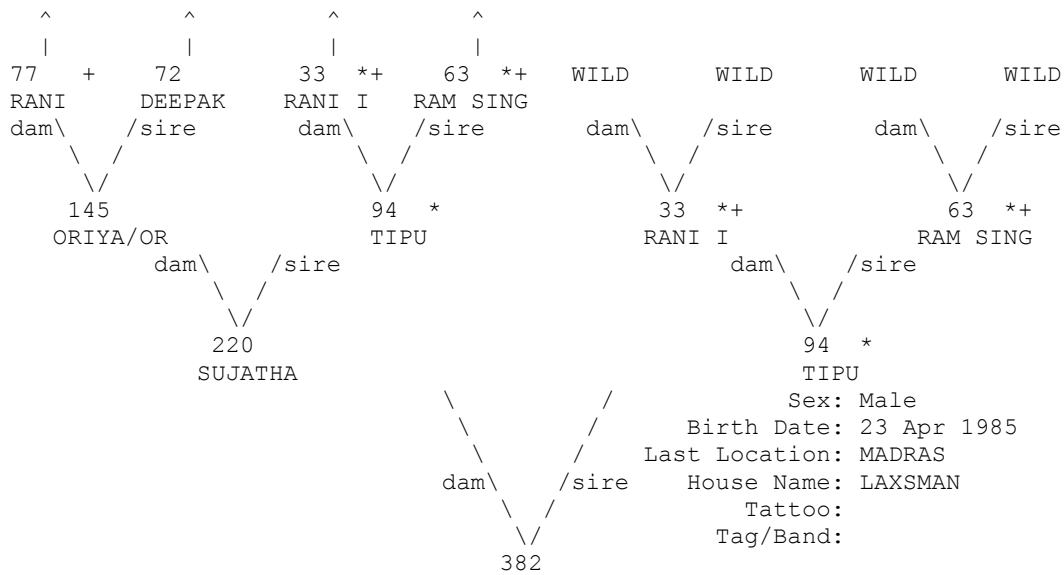

Sex: Male
 Birth Date: 23 Apr 1985
 Last Location: MADRAS
 House Name: LAXSMAN
 Tattoo:
 Tag/Band:

+ Wild-caught... * Appear more than once...
 ^ Pedigree continues beyond top of page...

=====
 Taxon Name: PANTHERA TIGRIS Studbook Number: 383
 =====

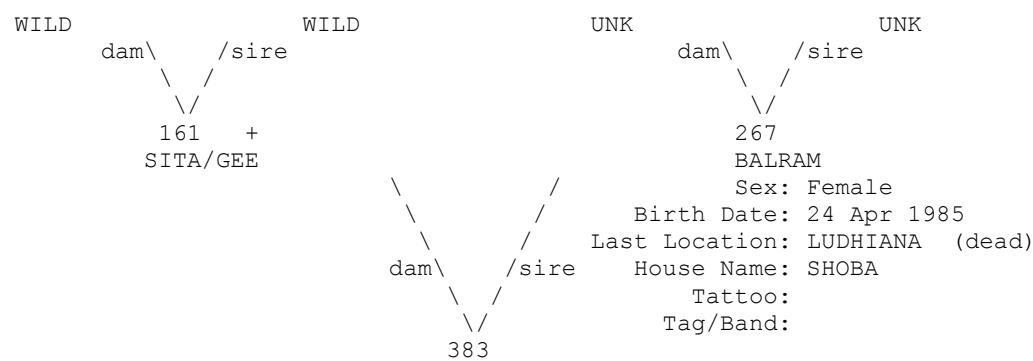

+ Wild-caught...

=====
 Taxon Name: PANTHERA TIGRIS Studbook Number: 384
 =====

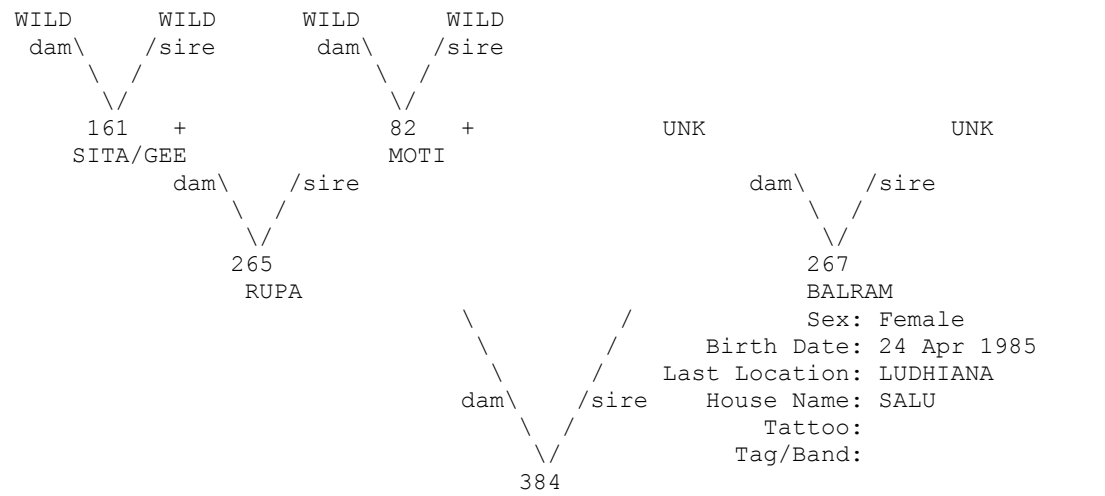

+ Wild-caught...

=====
 Taxon Name: PANTHERA TIGRIS Studbook Number: 385
 =====

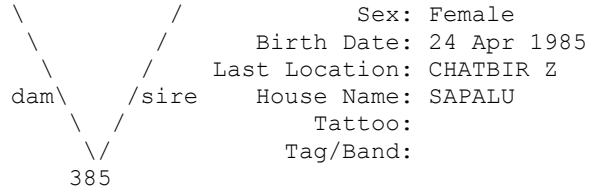
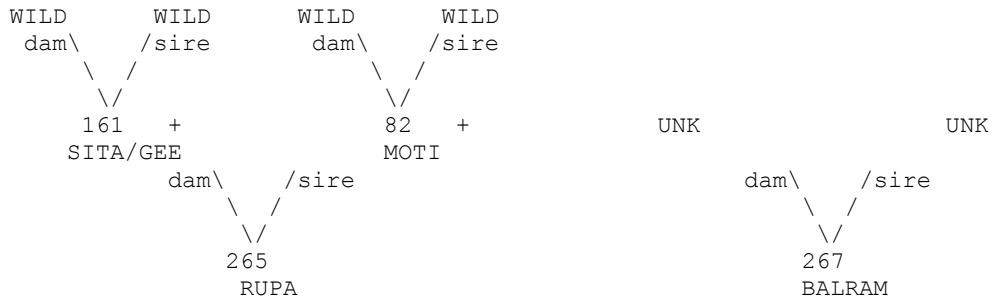

+ Wild-caught...

=====
 Taxon Name: PANTHERA TIGRIS Studbook Number: 386
 =====

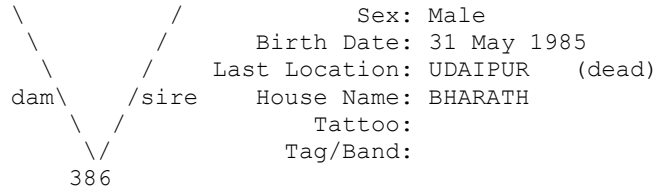
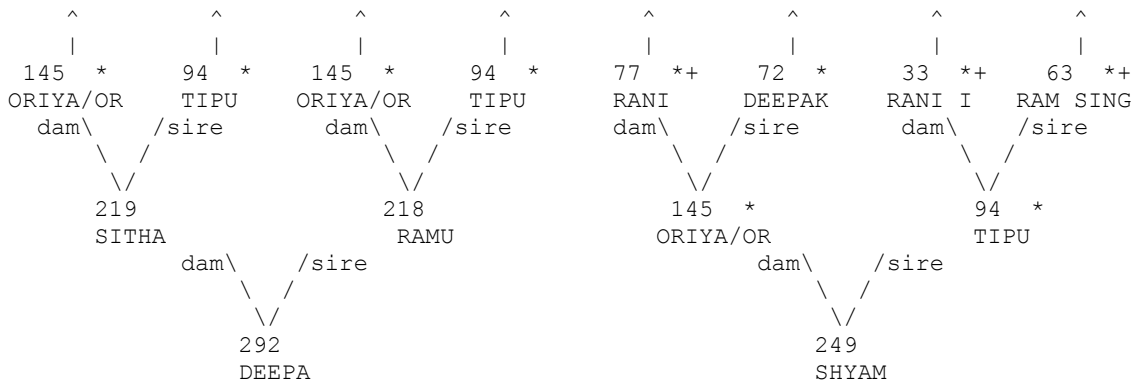

+ Wild-caught... * Appear more than once...

^ Pedigree continues beyond top of page...

=====

Taxon Name: PANTHERA TIGRIS Studbook Number: 387

=====

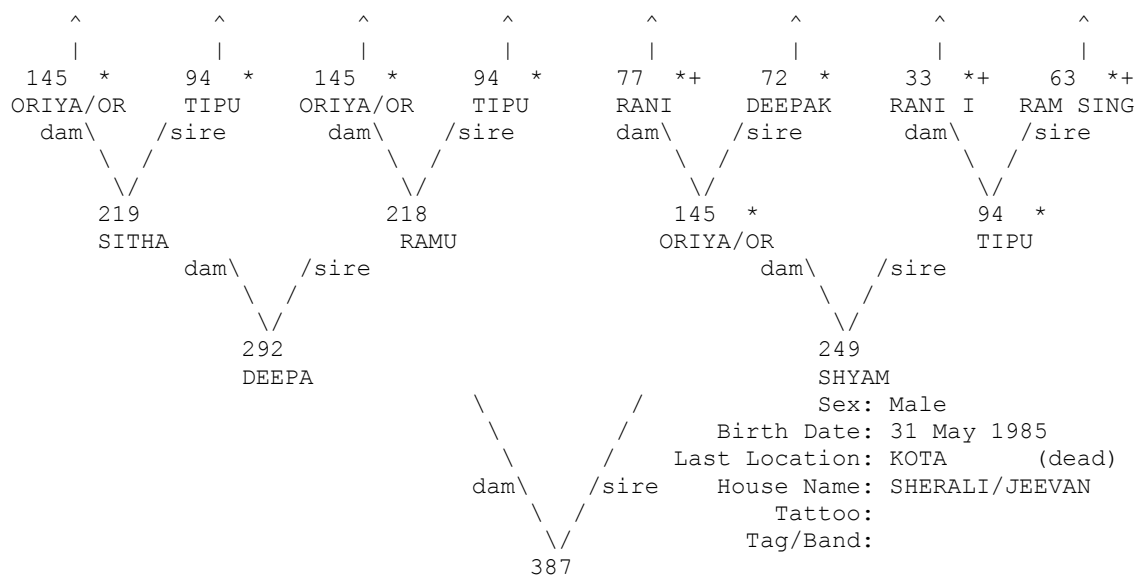

+ Wild-caught... * Appear more than once...
 ^ Pedigree continues beyond top of page...

=====

Taxon Name: PANTHERA TIGRIS Studbook Number: 388

=====

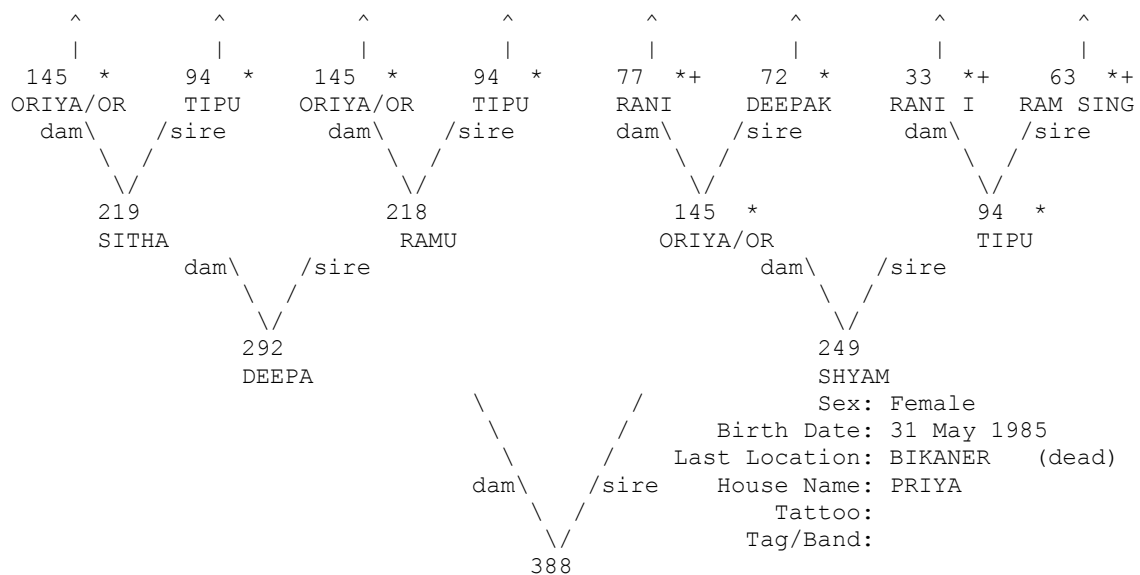

+ Wild-caught... * Appear more than once...
 ^ Pedigree continues beyond top of page...

=====

Taxon Name: PANTHERA TIGRIS Studbook Number: 389

=====

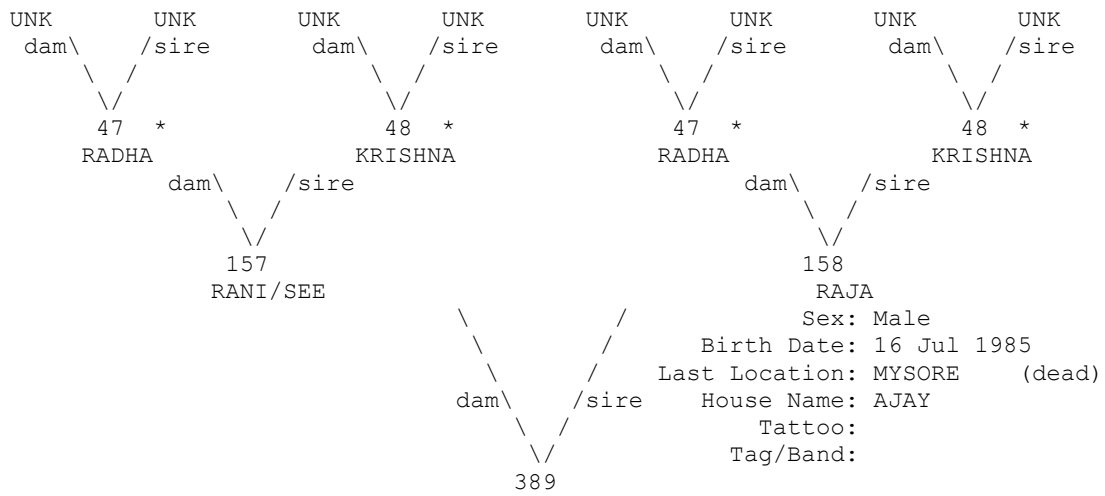

* Appear more than once...

=====

Taxon Name: PANTHERA TIGRIS Studbook Number: 390

=====

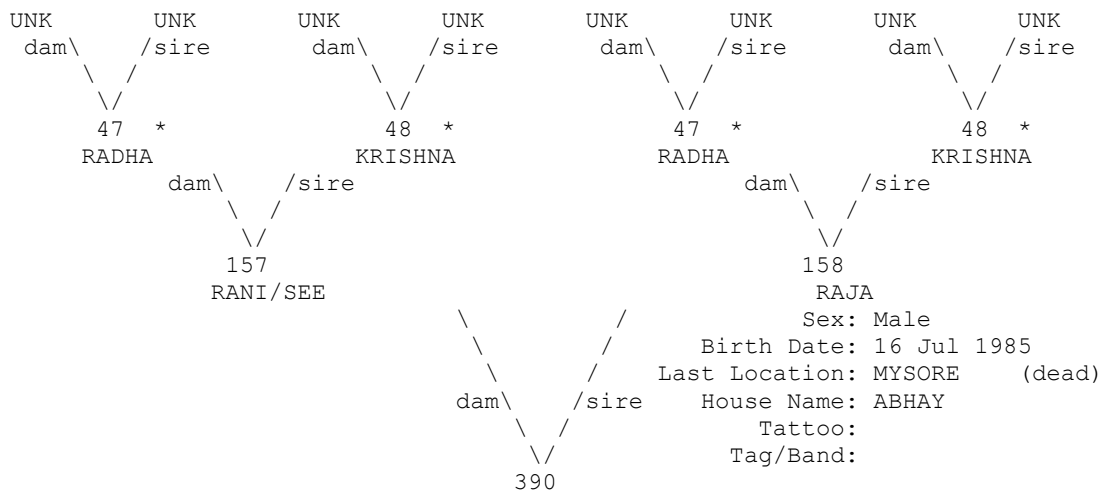

* Appear more than once...

=====
 Taxon Name: PANTHERA TIGRIS Studbook Number: 391
 =====

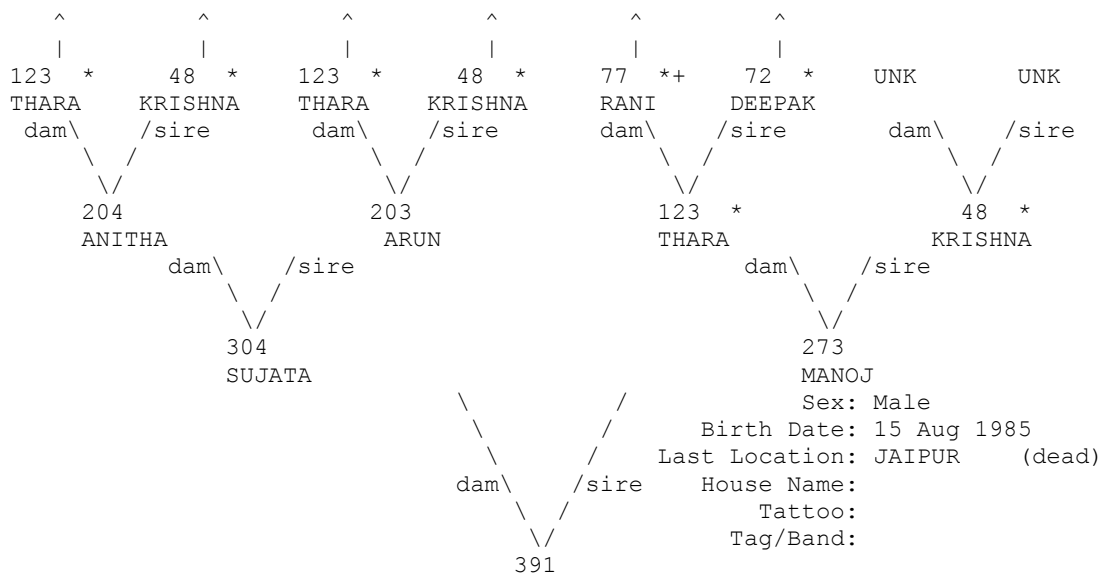

+ Wild-caught... * Appear more than once...
 ^ Pedigree continues beyond top of page...

=====
 Taxon Name: PANTHERA TIGRIS Studbook Number: 392
 =====

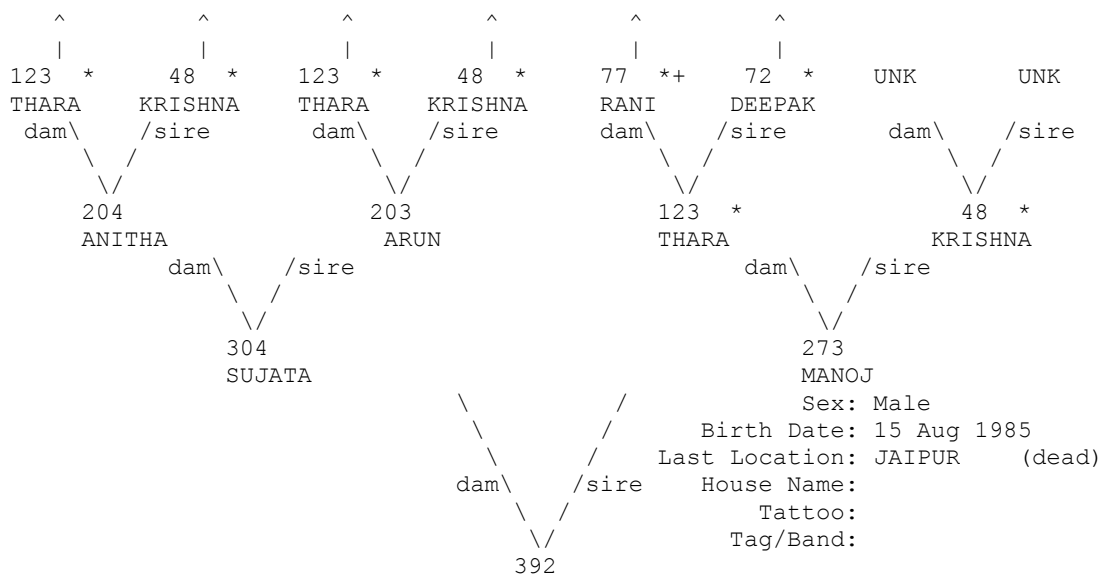

+ Wild-caught... * Appear more than once...
 ^ Pedigree continues beyond top of page...

=====
 Taxon Name: PANTHERA TIGRIS Studbook Number: 396
 =====

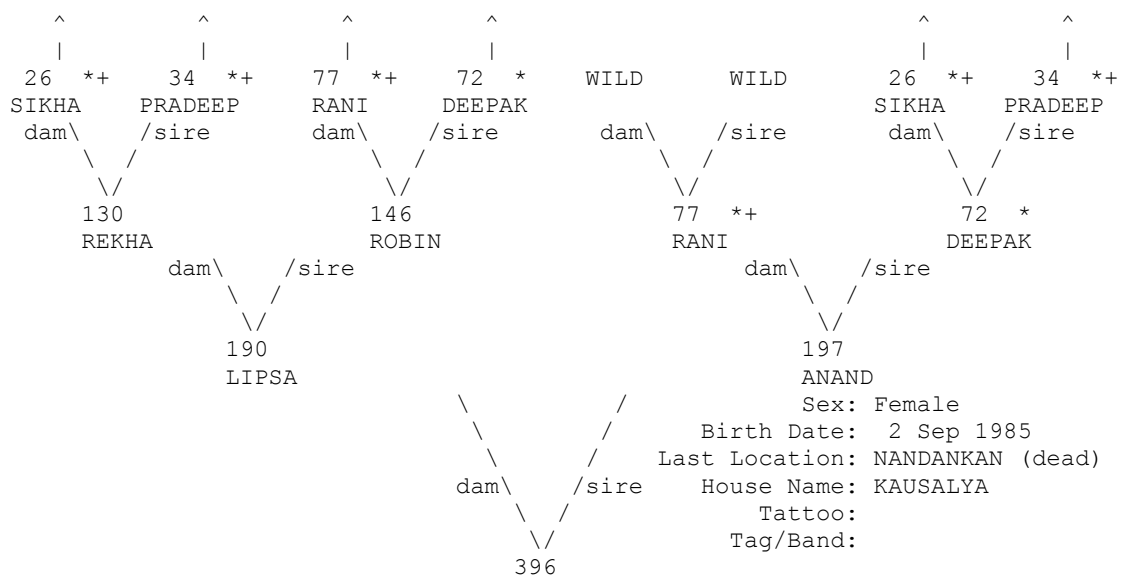

+ Wild-caught... * Appear more than once...
 ^ Pedigree continues beyond top of page...

=====
 Taxon Name: PANTHERA TIGRIS Studbook Number: 397
 =====

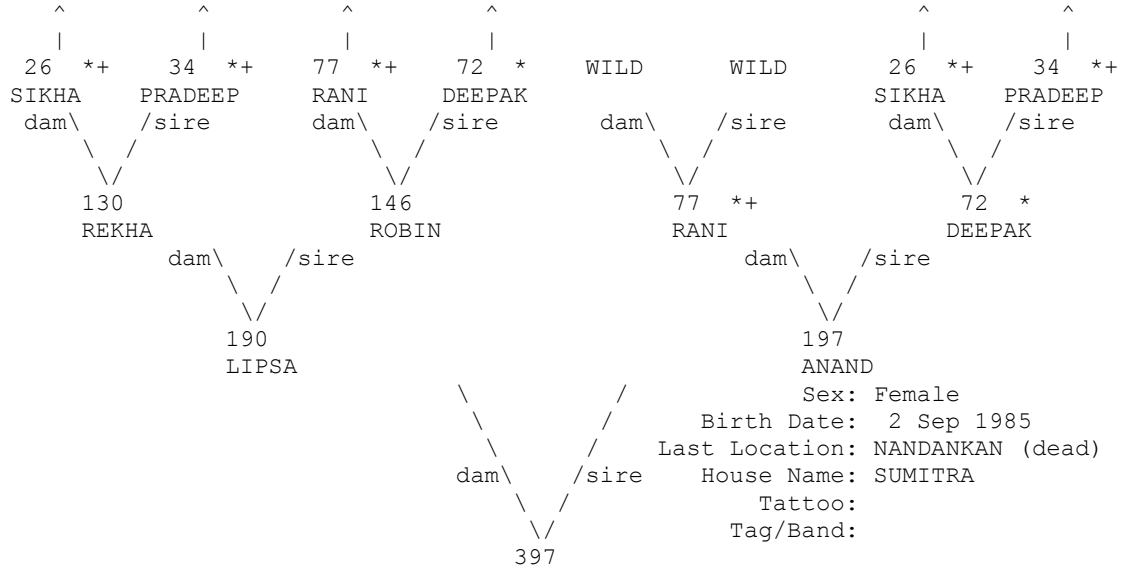

+ Wild-caught... * Appear more than once...
 ^ Pedigree continues beyond top of page...

=====
 Taxon Name: PANTHERA TIGRIS Studbook Number: 402
 =====

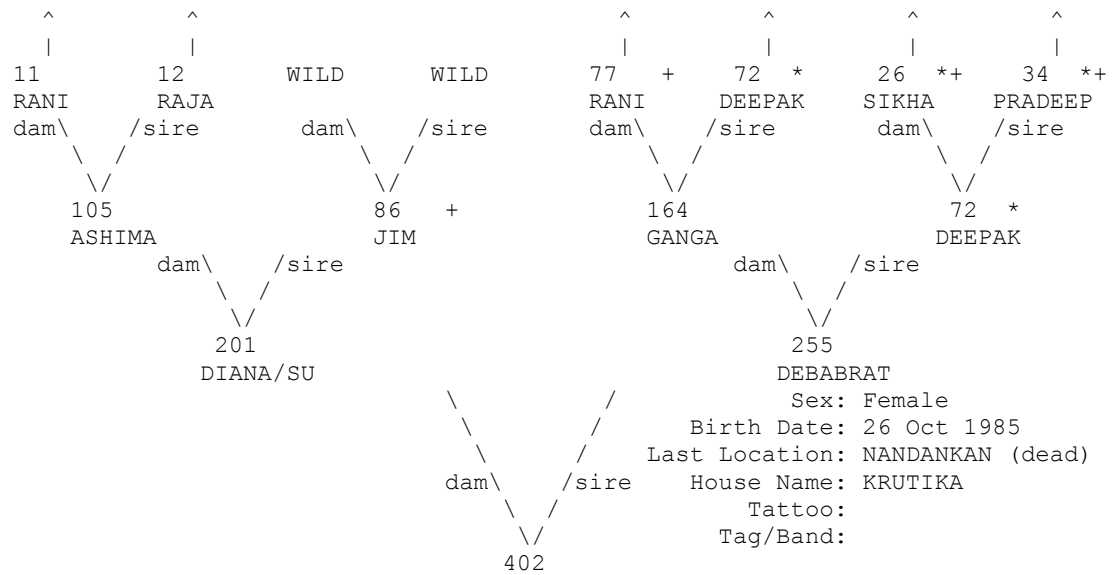

+ Wild-caught... * Appear more than once...
 ^ Pedigree continues beyond top of page...

=====
 Taxon Name: PANTHERA TIGRIS Studbook Number: 403
 =====

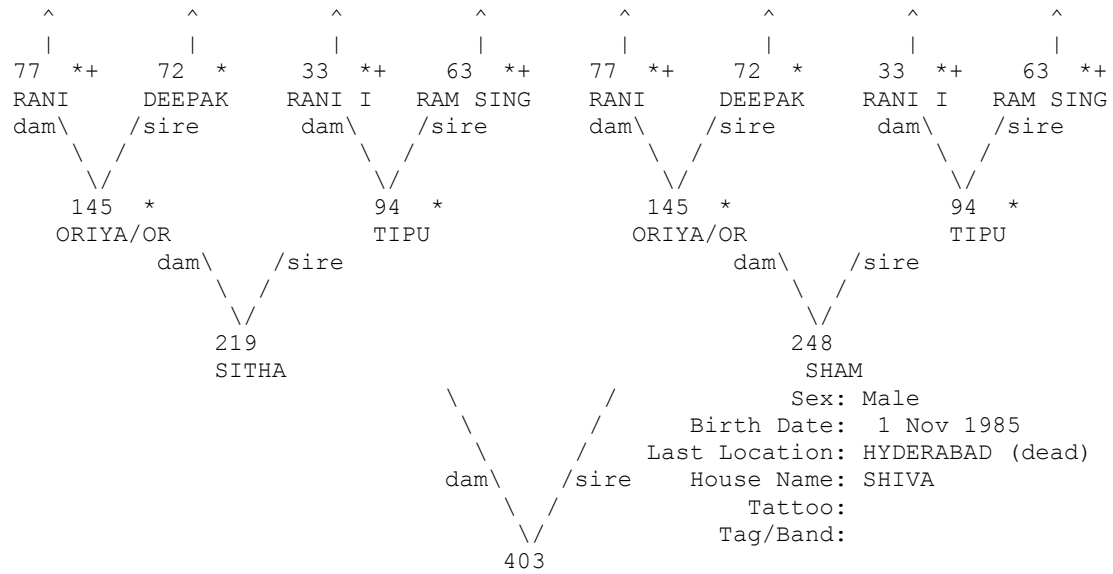

+ Wild-caught... * Appear more than once...
 ^ Pedigree continues beyond top of page...

=====
 Taxon Name: PANTHERA TIGRIS Studbook Number: 404
 =====

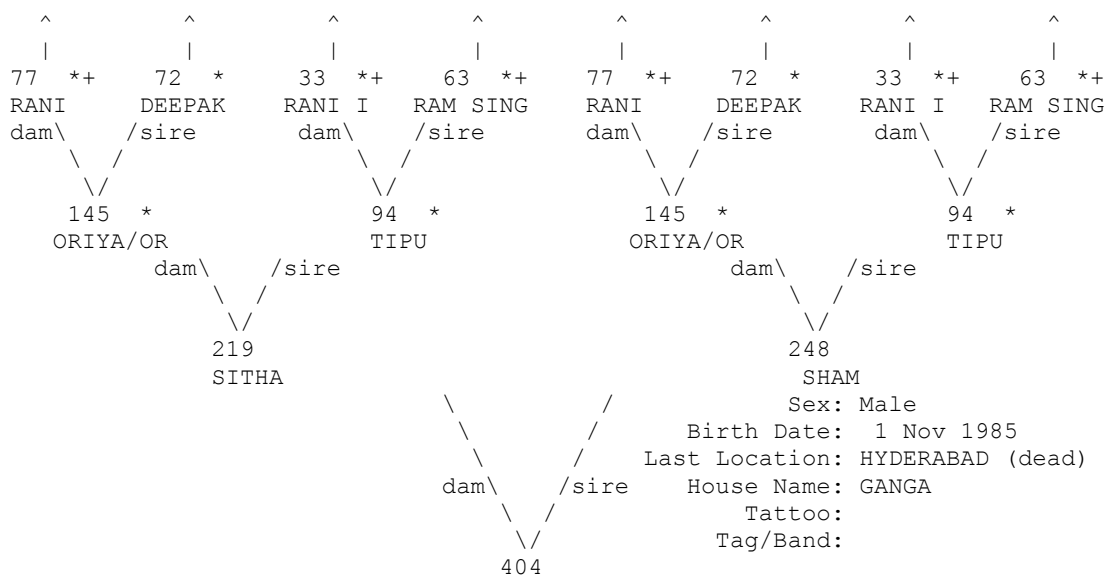

+ Wild-caught... * Appear more than once...
 ^ Pedigree continues beyond top of page...

=====
 Taxon Name: PANTHERA TIGRIS Studbook Number: 405
 =====

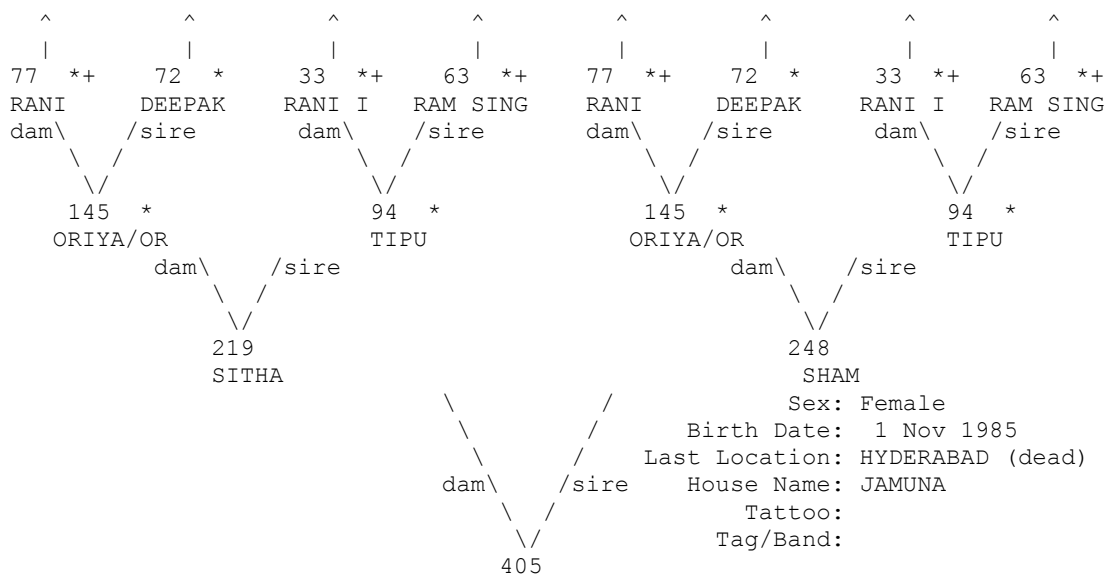

+ Wild-caught... * Appear more than once...
 ^ Pedigree continues beyond top of page...

=====
 Taxon Name: PANTHERA TIGRIS Studbook Number: 409
 =====

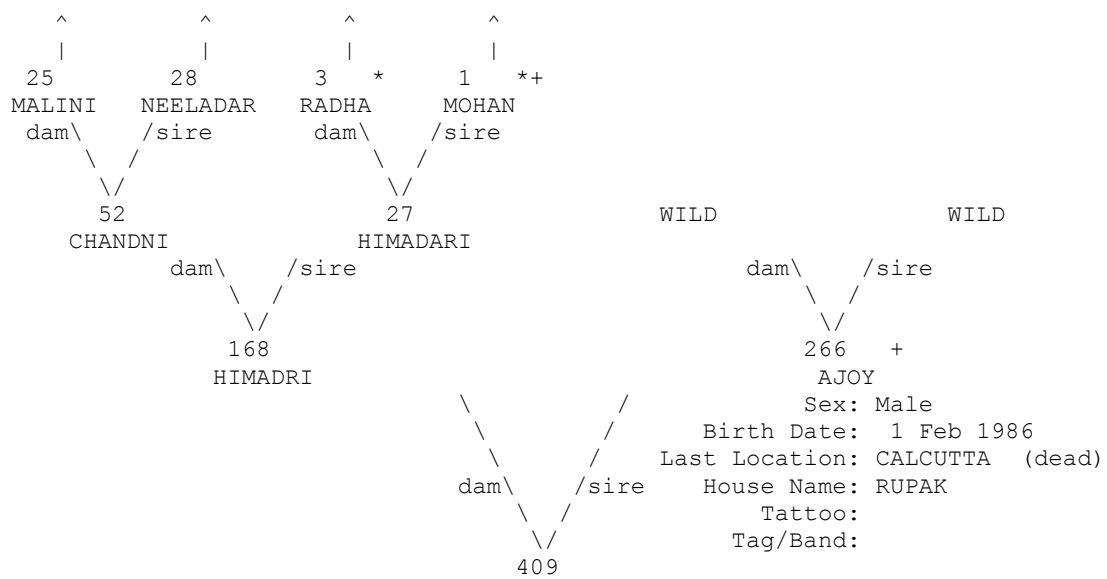

+ Wild-caught... * Appear more than once...
 ^ Pedigree continues beyond top of page...

=====
 Taxon Name: PANTHERA TIGRIS Studbook Number: 410
 =====

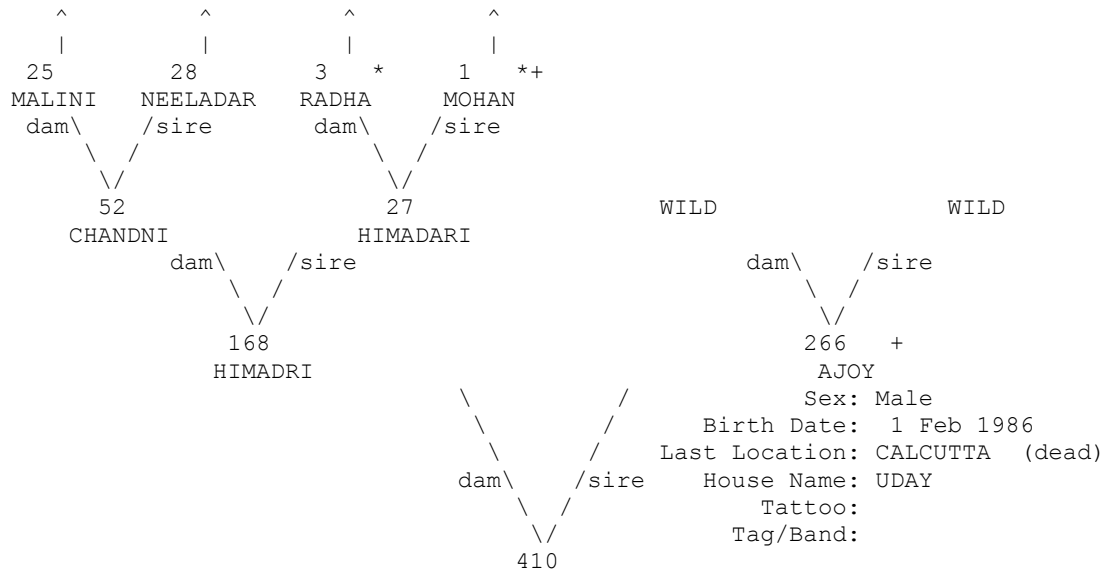

+ Wild-caught... * Appear more than once...
 ^ Pedigree continues beyond top of page...

=====
 Taxon Name: PANTHERA TIGRIS Studbook Number: 411
 =====

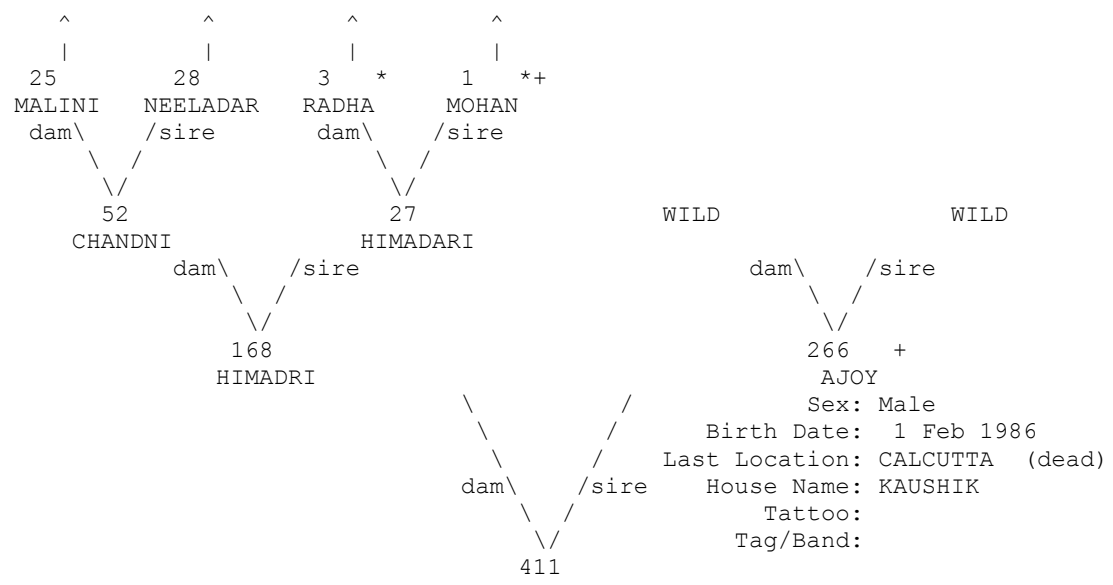

+ Wild-caught... * Appear more than once...
 ^ Pedigree continues beyond top of page...

=====
 Taxon Name: PANTHERA TIGRIS Studbook Number: 412
 =====

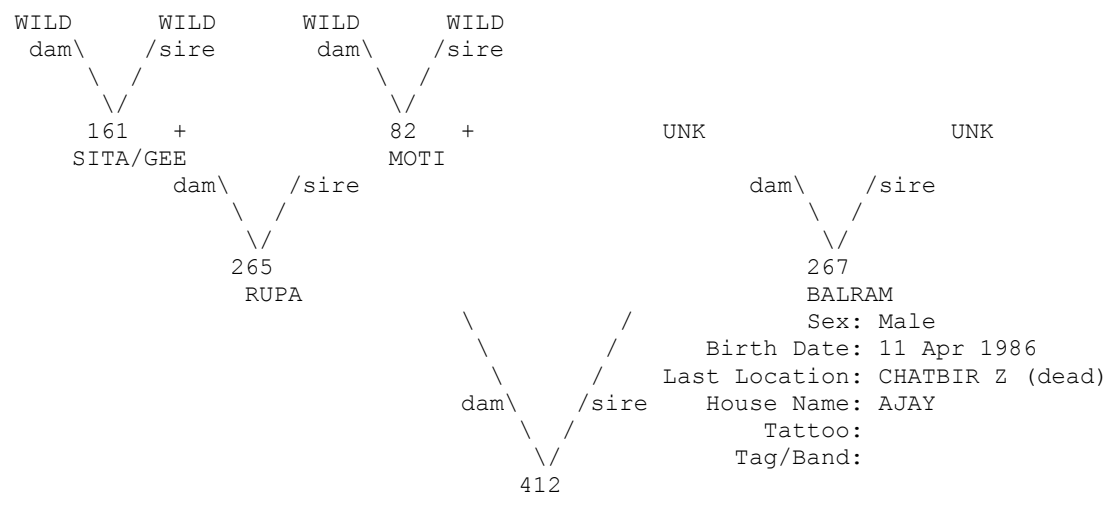

+ Wild-caught...

=====
 Taxon Name: PANTHERA TIGRIS Studbook Number: 413
 =====

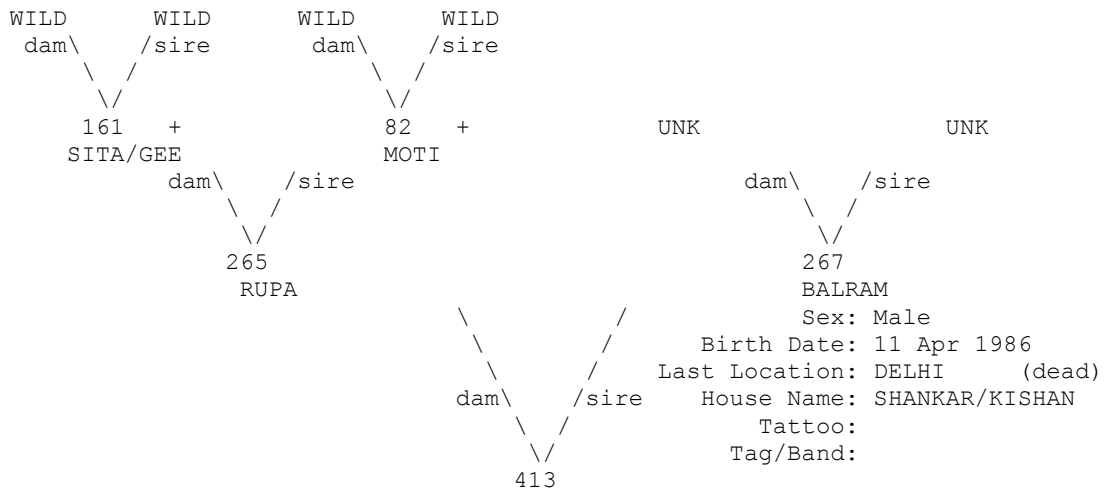

+ Wild-caught...

=====
 Taxon Name: PANTHERA TIGRIS Studbook Number: 414
 =====

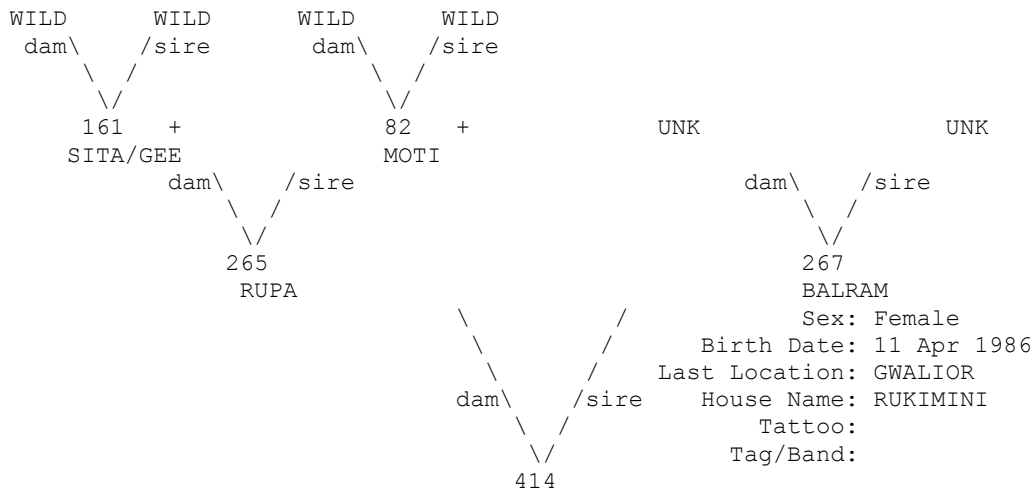

+ Wild-caught...

=====
 Taxon Name: PANTHERA TIGRIS Studbook Number: 415
 =====

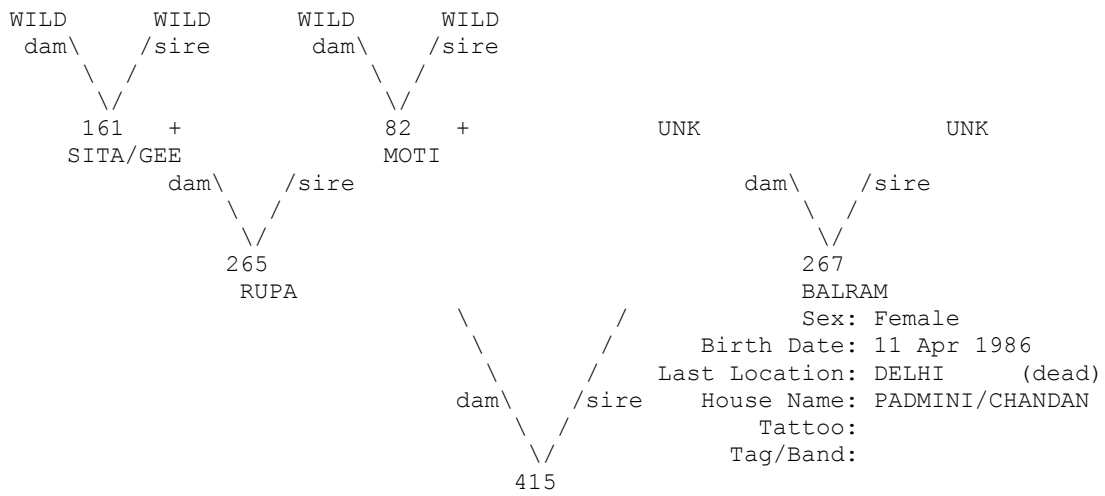

+ Wild-caught...

=====
 Taxon Name: PANTHERA TIGRIS Studbook Number: 416
 =====

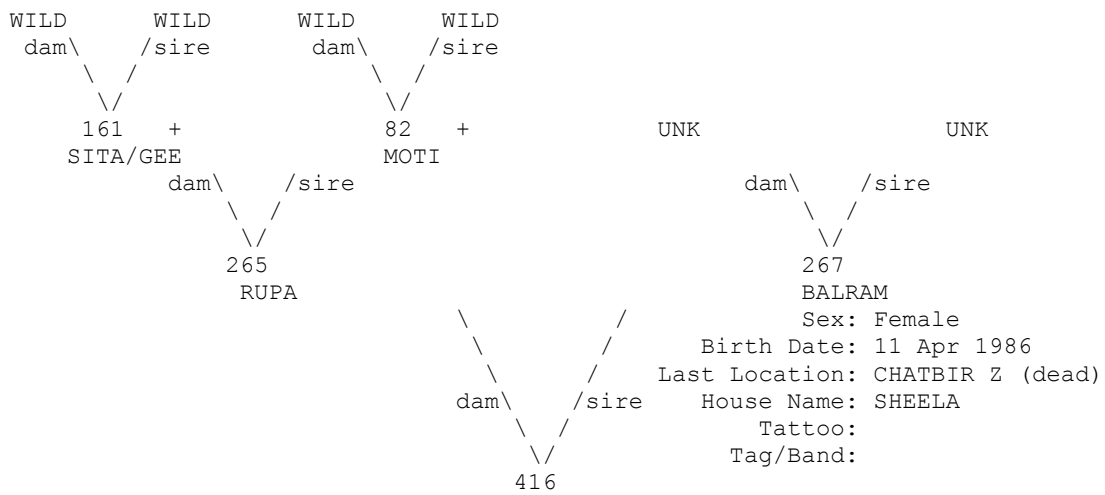

+ Wild-caught...

=====
 Taxon Name: PANTHERA TIGRIS Studbook Number: 417
 =====

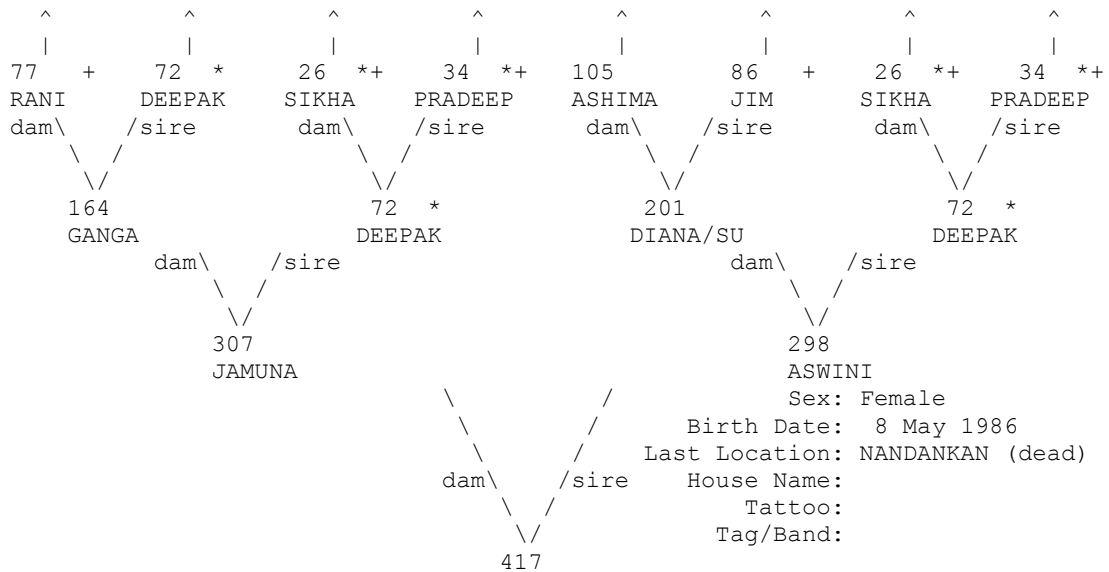

+ Wild-caught... * Appear more than once...
 ^ Pedigree continues beyond top of page...

=====
 Taxon Name: PANTHERA TIGRIS Studbook Number: 418
 =====

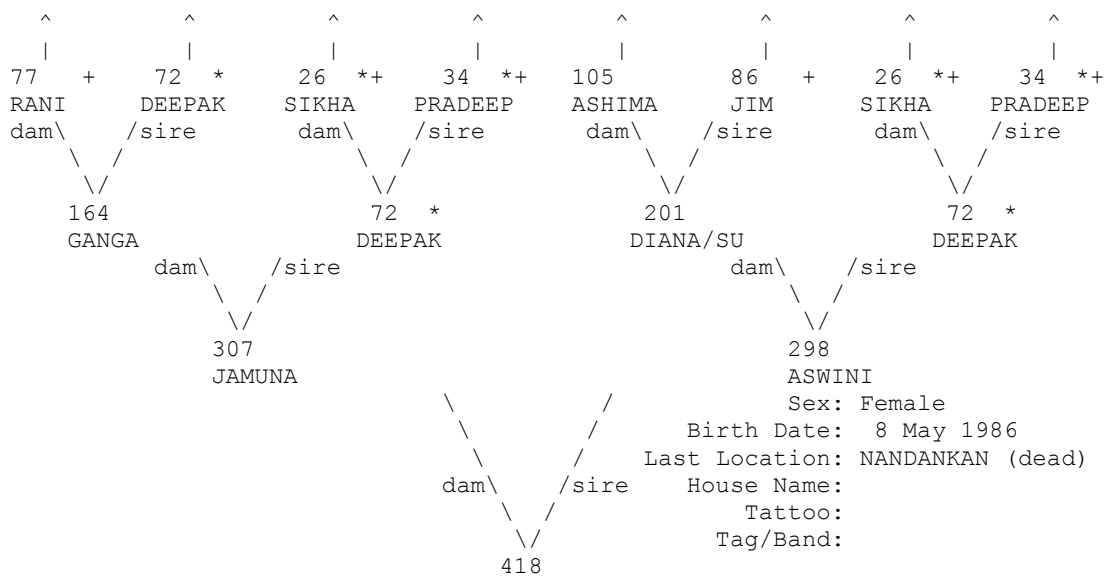

+ Wild-caught... * Appear more than once...
 ^ Pedigree continues beyond top of page...

=====
 Taxon Name: PANTHERA TIGRIS Studbook Number: 419
 =====

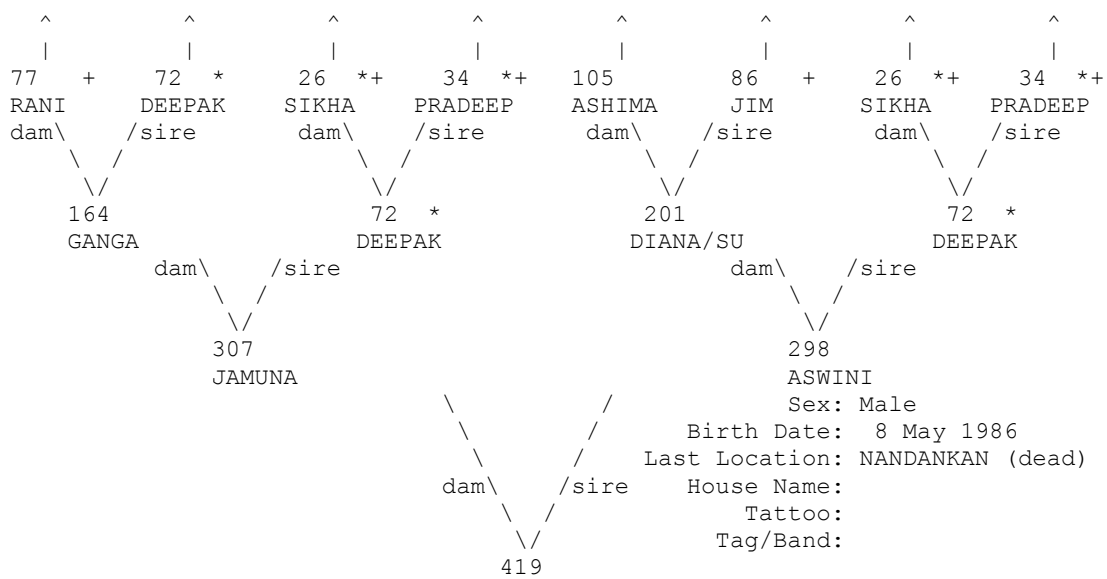

+ Wild-caught... * Appear more than once...
 ^ Pedigree continues beyond top of page...

=====
 Taxon Name: PANTHERA TIGRIS Studbook Number: 420
 =====

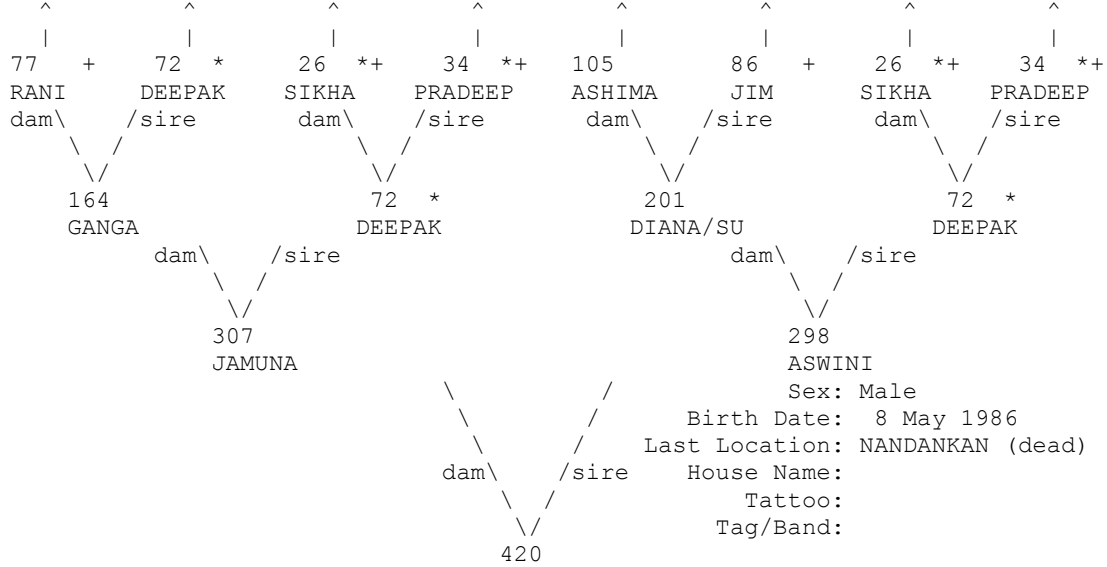

+ Wild-caught... * Appear more than once...
 ^ Pedigree continues beyond top of page...

=====
 Taxon Name: PANTHERA TIGRIS Studbook Number: 421
 =====

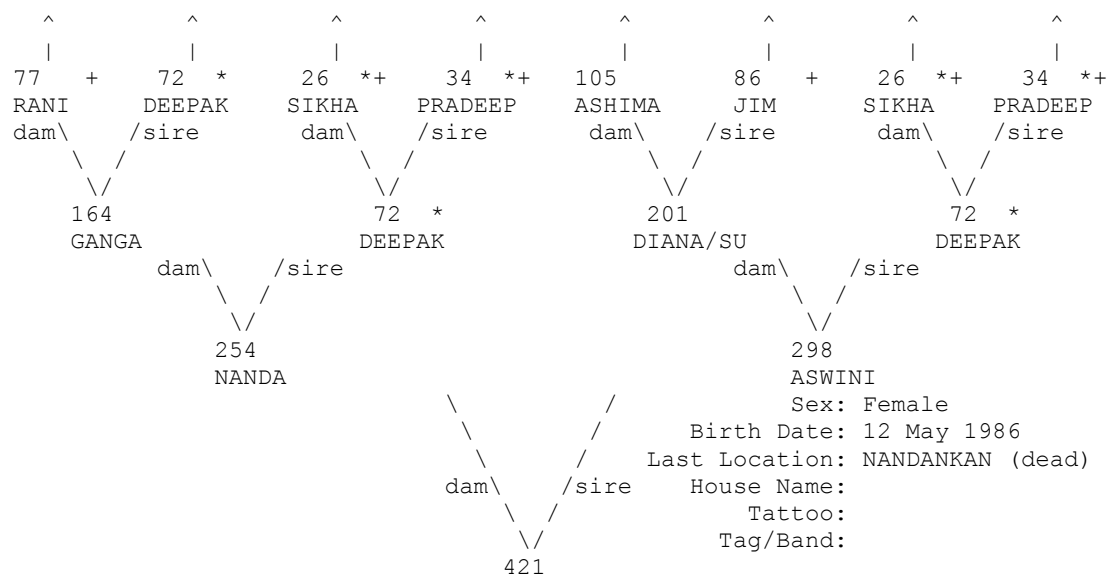

+ Wild-caught... * Appear more than once...
 ^ Pedigree continues beyond top of page...

=====
 Taxon Name: PANTHERA TIGRIS Studbook Number: 422
 =====

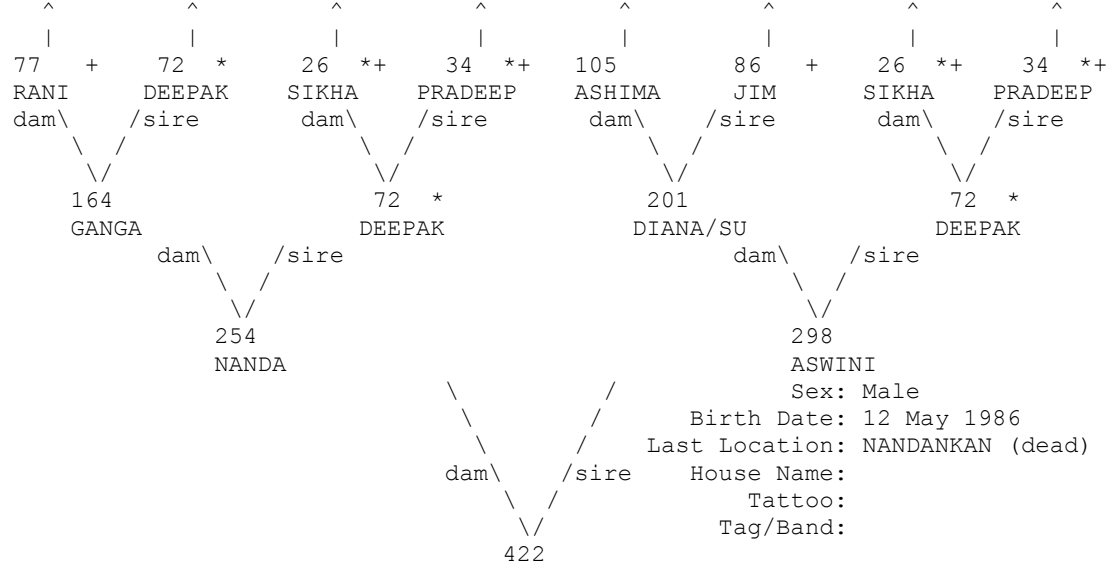

+ Wild-caught... * Appear more than once...
 ^ Pedigree continues beyond top of page...

=====
 Taxon Name: PANTHERA TIGRIS Studbook Number: 423
 =====

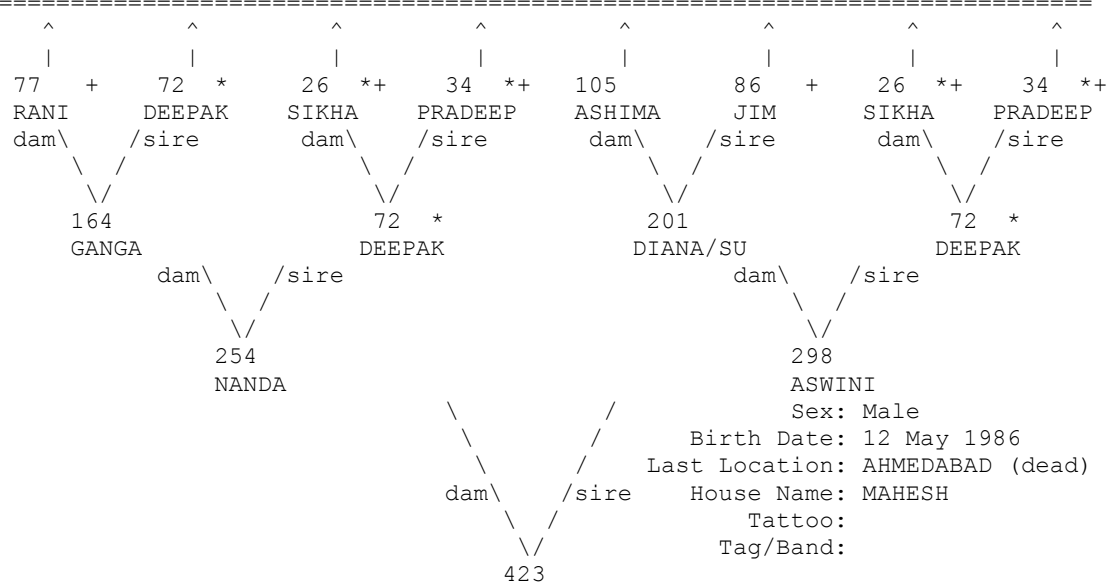

+ Wild-caught... * Appear more than once...
 ^ Pedigree continues beyond top of page...

=====
 Taxon Name: PANTHERA TIGRIS Studbook Number: 424
 =====

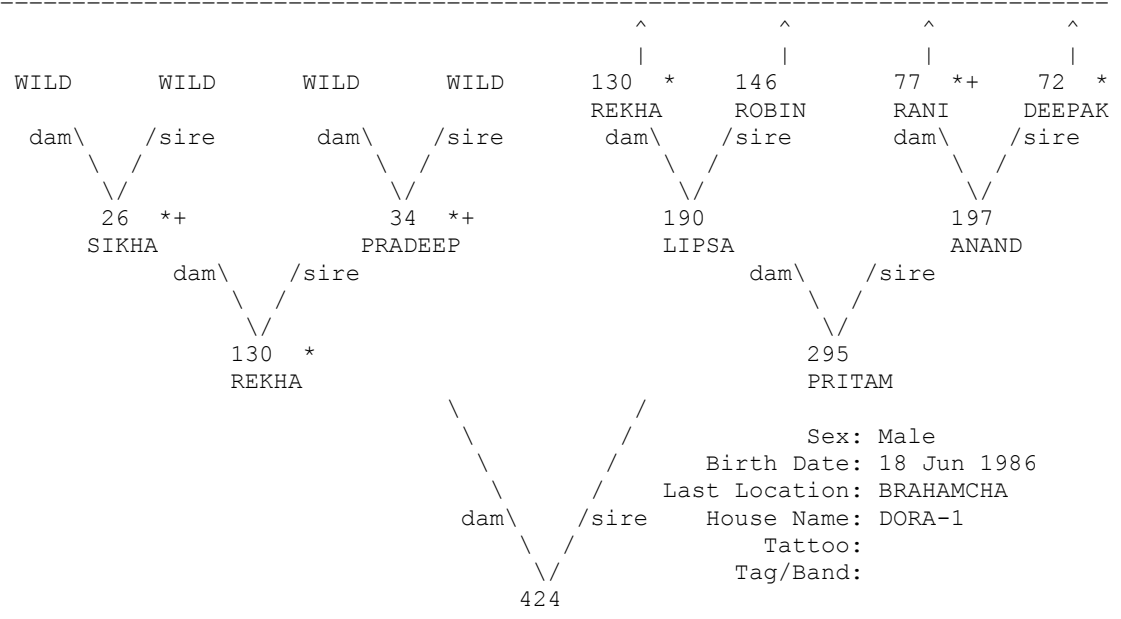

+ Wild-caught... * Appear more than once...
 ^ Pedigree continues beyond top of page...

=====
 Taxon Name: PANTHERA TIGRIS Studbook Number: 425
 =====

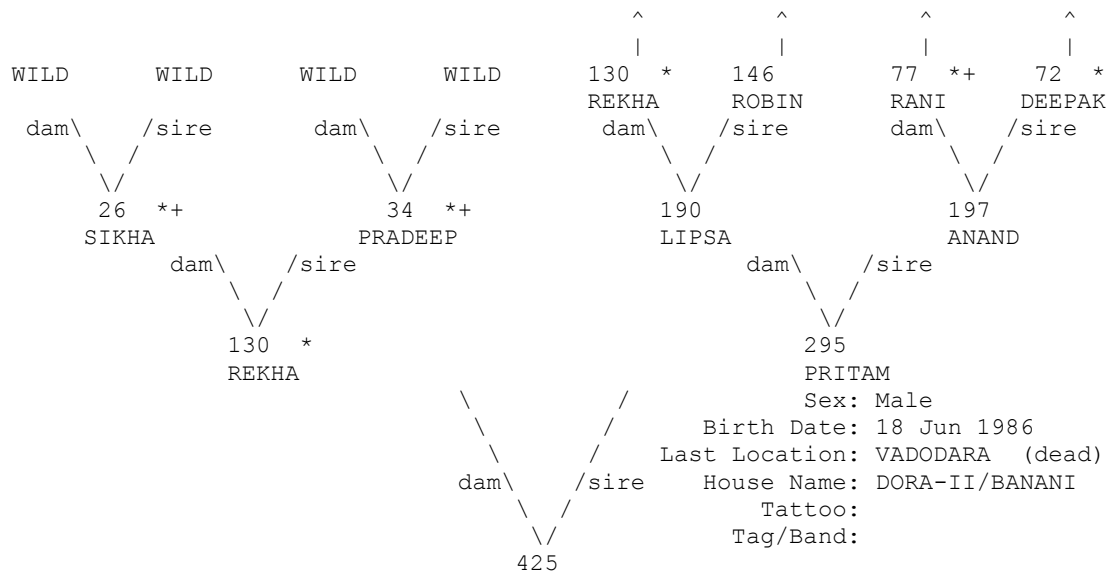

+ Wild-caught... * Appear more than once...
 ^ Pedigree continues beyond top of page...

=====
 Taxon Name: PANTHERA TIGRIS Studbook Number: 426
 =====

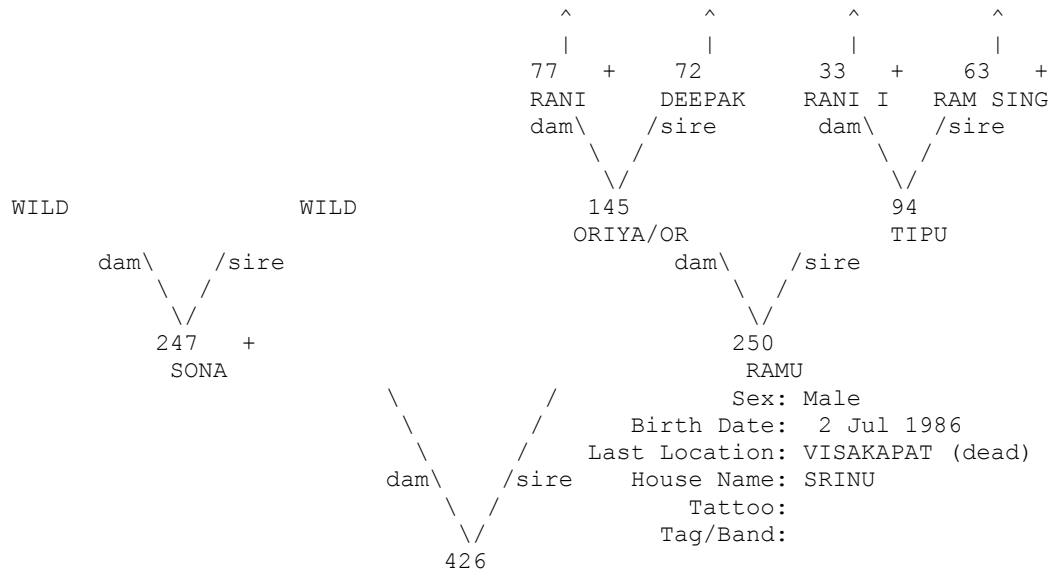

^ Pedigree continues beyond top of page...

```
=====
Taxon Name: PANTHERA TIGRIS                               Studbook Number: 429
=====
```

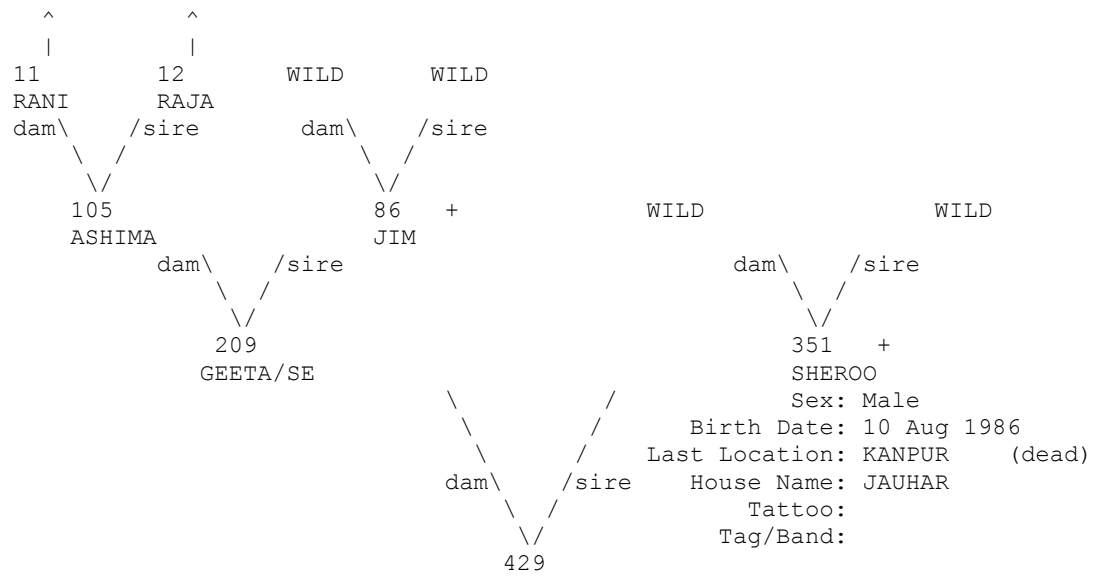

+ Wild-caught... * Appear more than once...
 ^ Pedigree continues beyond top of page...

```
=====
Taxon Name: PANTHERA TIGRIS                               Studbook Number: 430
=====
```

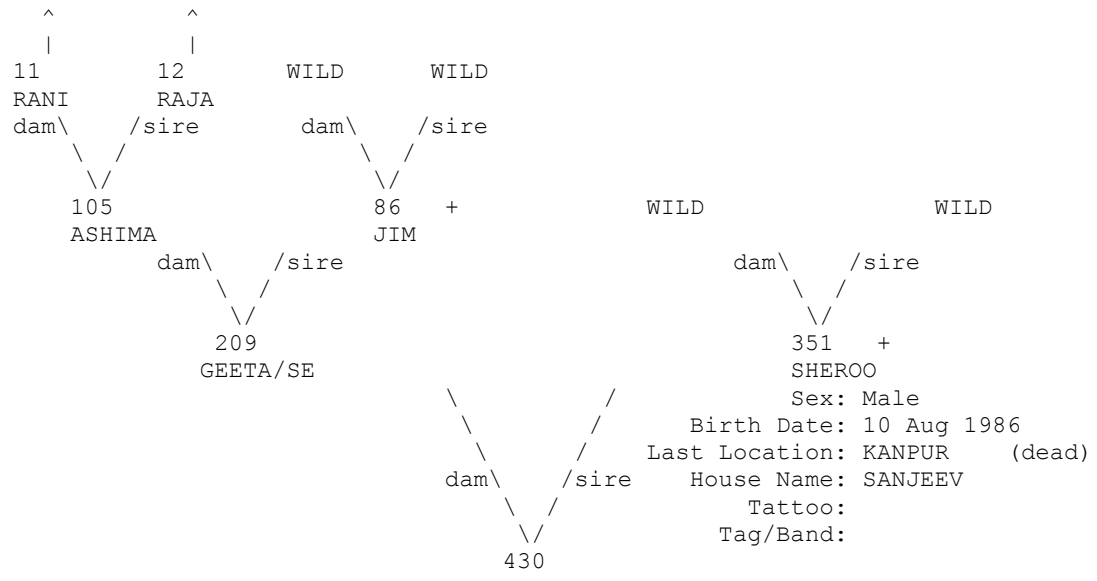

+ Wild-caught... * Appear more than once...
 ^ Pedigree continues beyond top of page...

=====
 Taxon Name: PANTHERA TIGRIS Studbook Number: 431
 =====

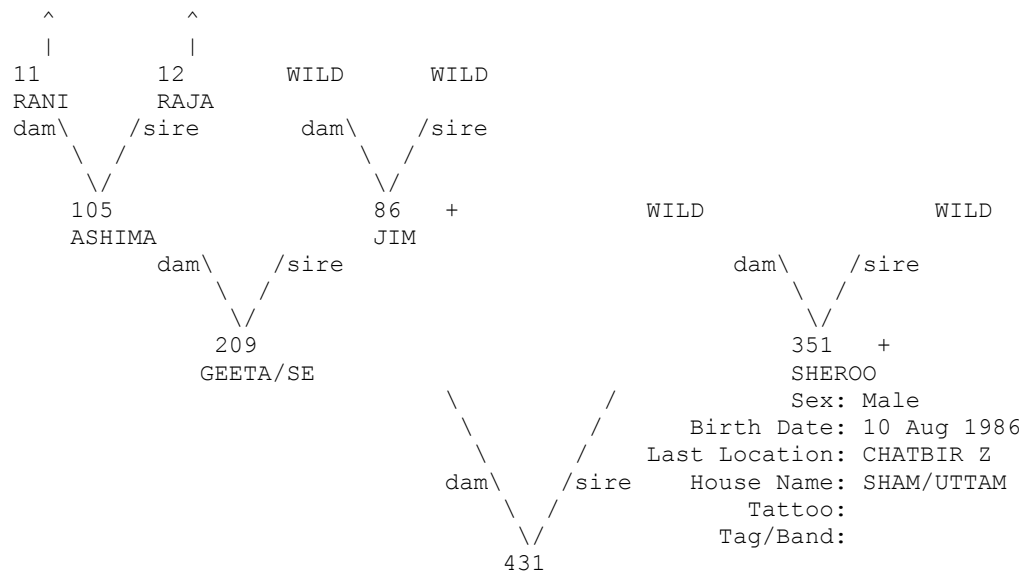

+ Wild-caught... * Appear more than once...
 ^ Pedigree continues beyond top of page...

=====
 Taxon Name: PANTHERA TIGRIS Studbook Number: 432
 =====

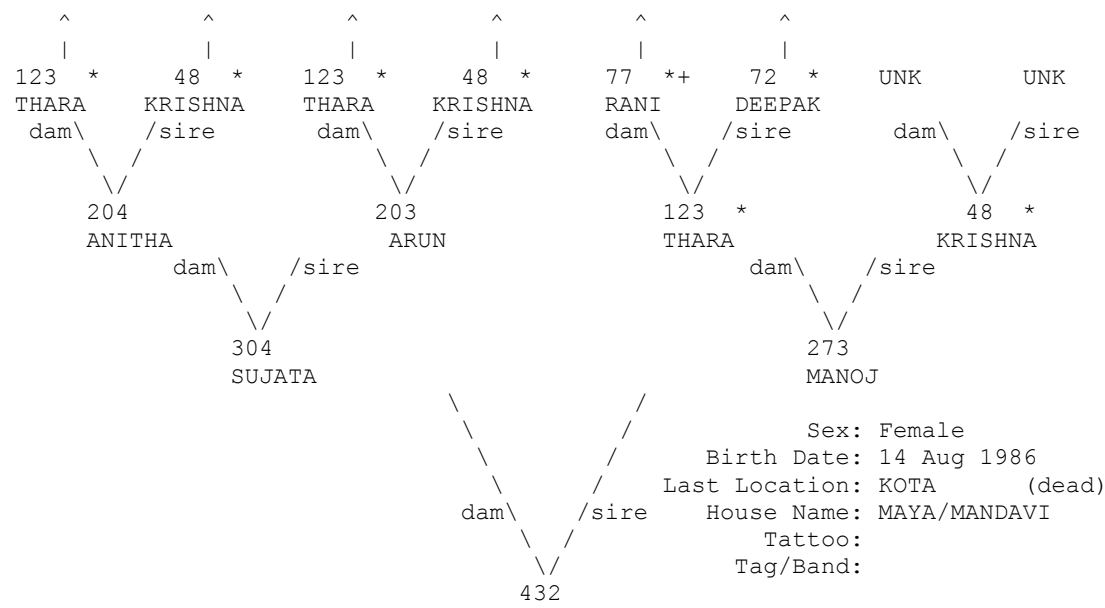

+ Wild-caught... * Appear more than once...
 ^ Pedigree continues beyond top of page...

=====
 Taxon Name: PANTHERA TIGRIS Studbook Number: 433
 =====

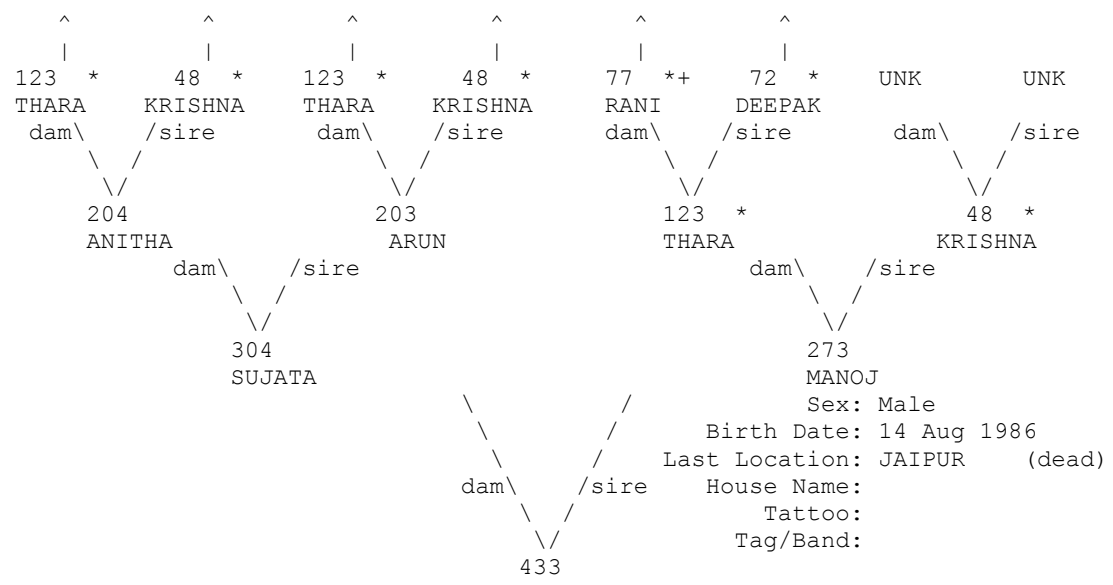

+ Wild-caught... * Appear more than once...
 ^ Pedigree continues beyond top of page...

=====
 Taxon Name: PANTHERA TIGRIS Studbook Number: 434
 =====

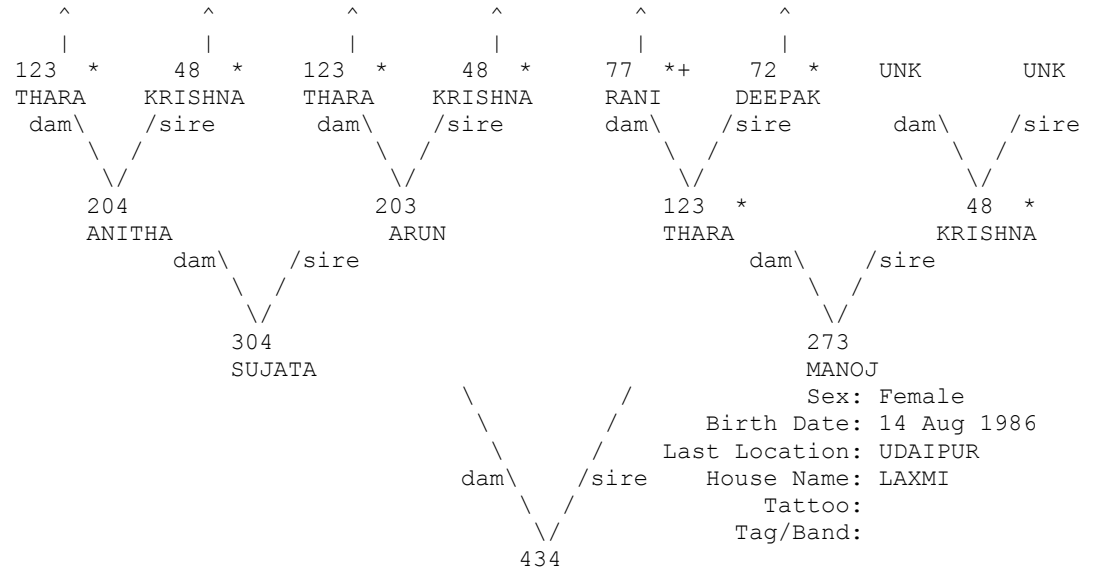

+ Wild-caught... * Appear more than once...
 ^ Pedigree continues beyond top of page...

=====
 Taxon Name: PANTHERA TIGRIS Studbook Number: 435
 =====

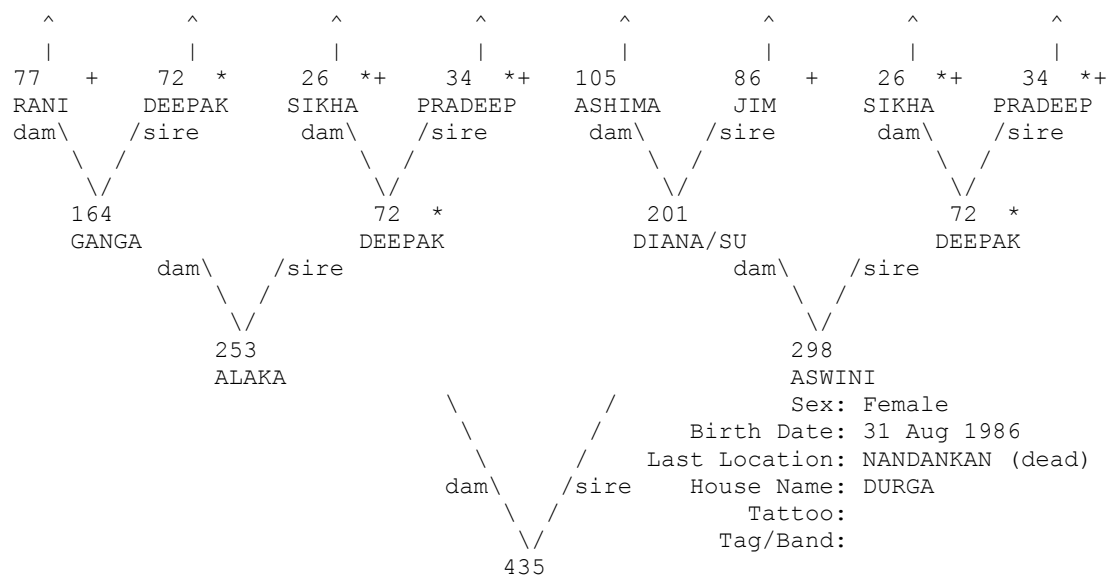

+ Wild-caught... * Appear more than once...
 ^ Pedigree continues beyond top of page...

=====
 Taxon Name: PANTHERA TIGRIS Studbook Number: 436
 =====

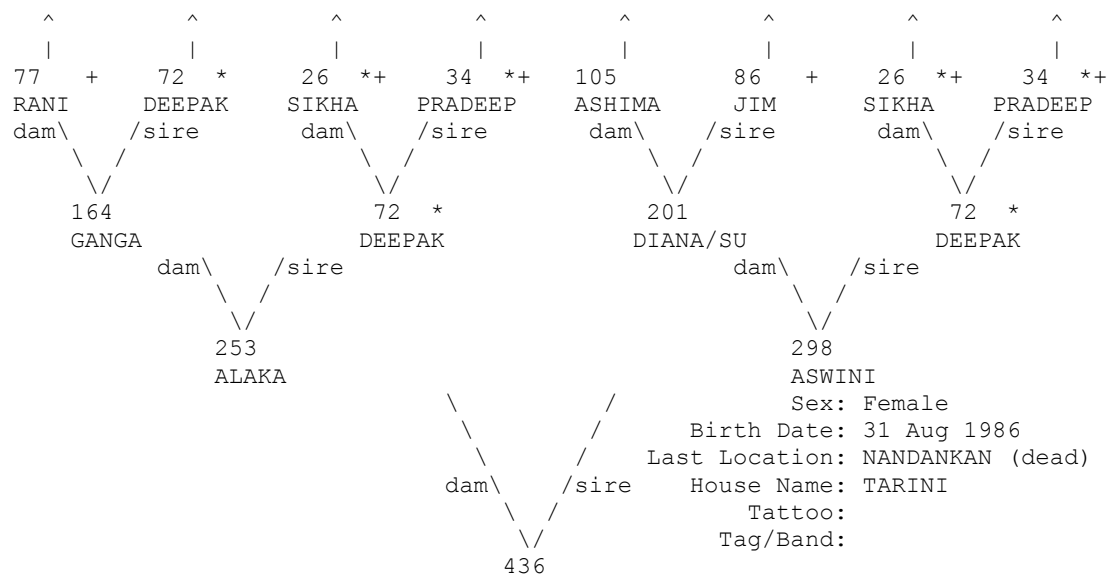

+ Wild-caught... * Appear more than once...
 ^ Pedigree continues beyond top of page...

=====
 Taxon Name: PANTHERA TIGRIS Studbook Number: 439
 =====

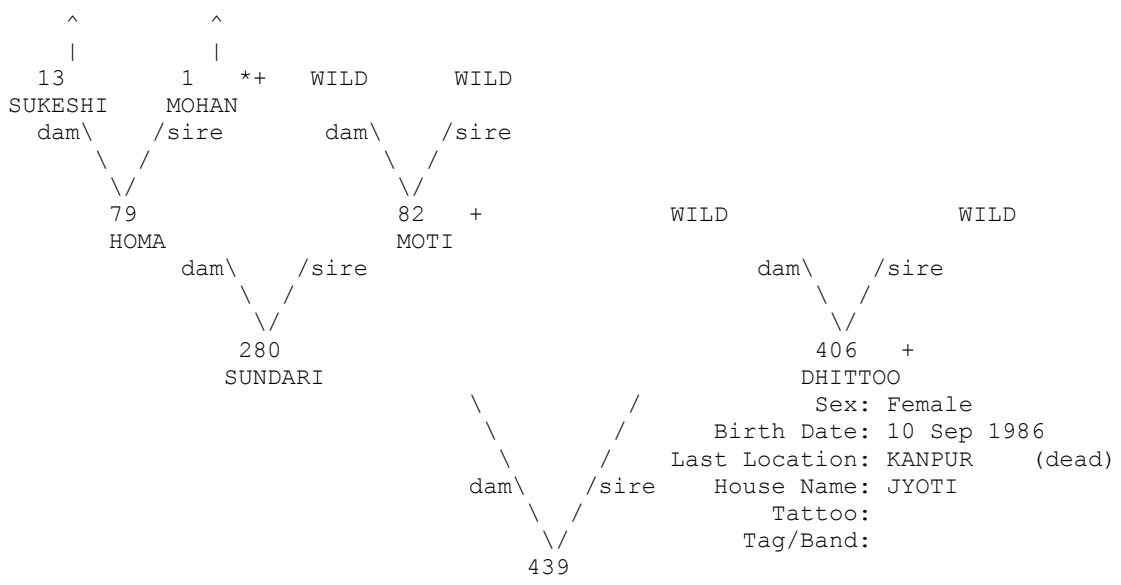

+ Wild-caught... * Appear more than once...
 ^ Pedigree continues beyond top of page...

=====
 Taxon Name: PANTHERA TIGRIS Studbook Number: 440
 =====

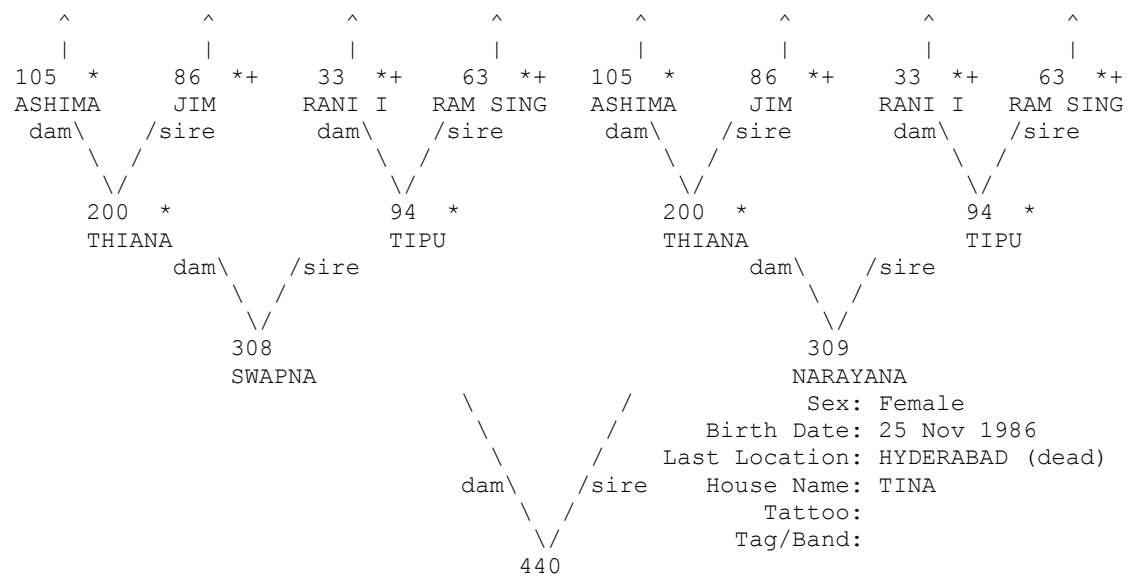

+ Wild-caught... * Appear more than once...
 ^ Pedigree continues beyond top of page...

=====
 Taxon Name: PANTHERA TIGRIS Studbook Number: 441
 =====

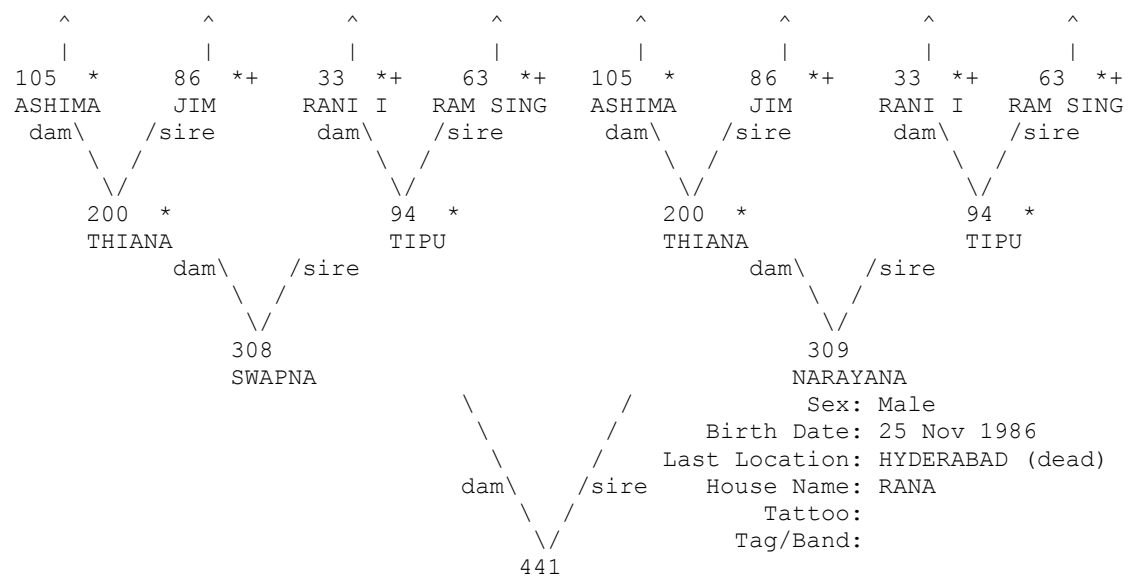

+ Wild-caught... * Appear more than once...
 ^ Pedigree continues beyond top of page...

=====
 Taxon Name: PANTHERA TIGRIS Studbook Number: 442
 =====

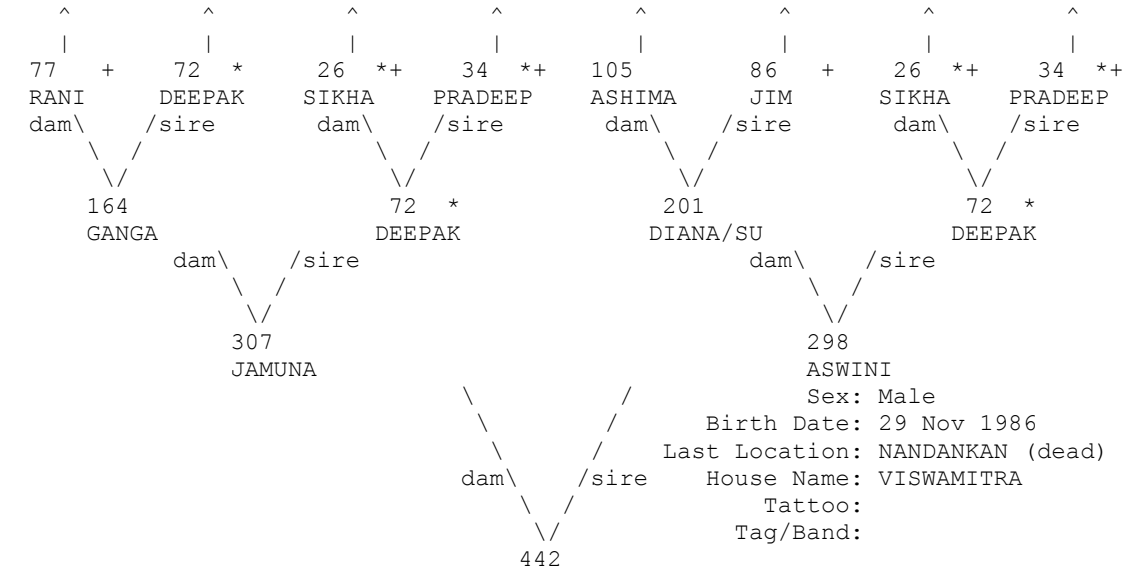

+ Wild-caught... * Appear more than once...
 ^ Pedigree continues beyond top of page...

=====
 Taxon Name: PANTHERA TIGRIS Studbook Number: 443
 =====

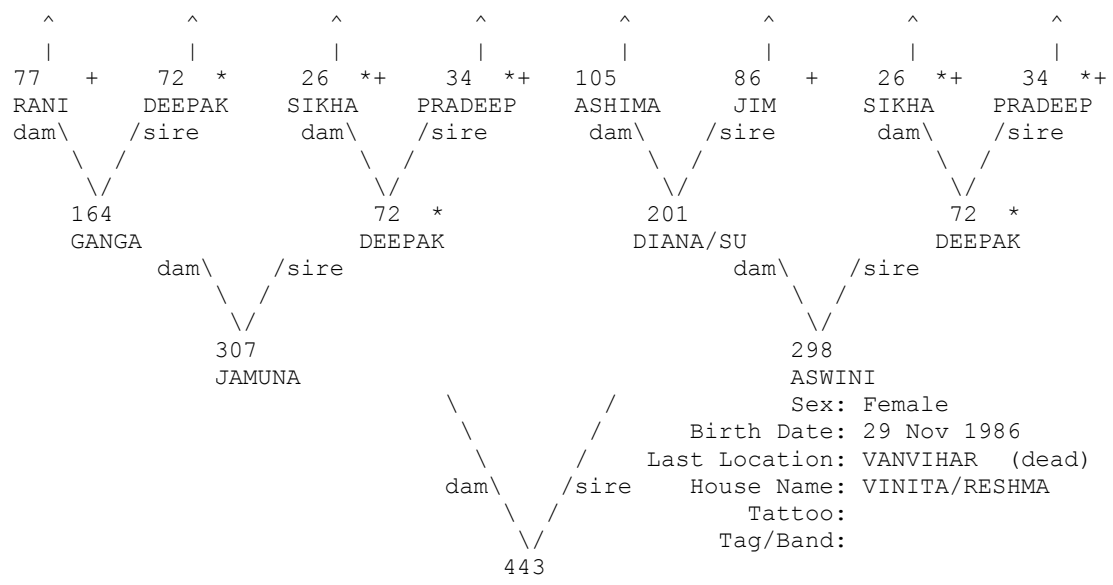

+ Wild-caught... * Appear more than once...
 ^ Pedigree continues beyond top of page...

=====
 Taxon Name: PANTHERA TIGRIS Studbook Number: 444
 =====

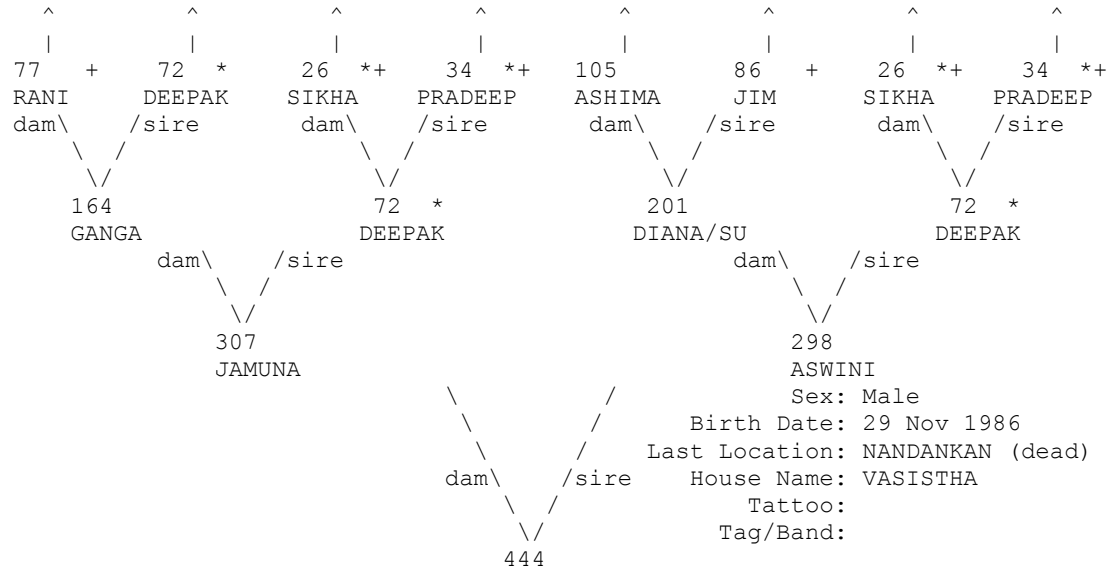

+ Wild-caught... * Appear more than once...
 ^ Pedigree continues beyond top of page...

=====
 Taxon Name: PANTHERA TIGRIS Studbook Number: 445
 =====

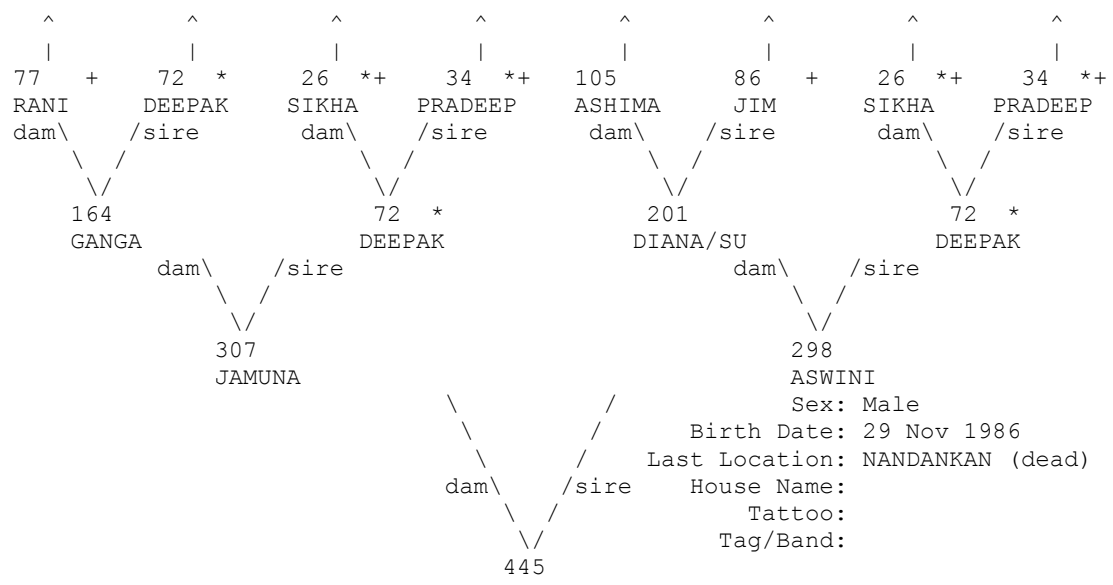

+ Wild-caught... * Appear more than once...
 ^ Pedigree continues beyond top of page...

=====
 Taxon Name: PANTHERA TIGRIS Studbook Number: 446
 =====

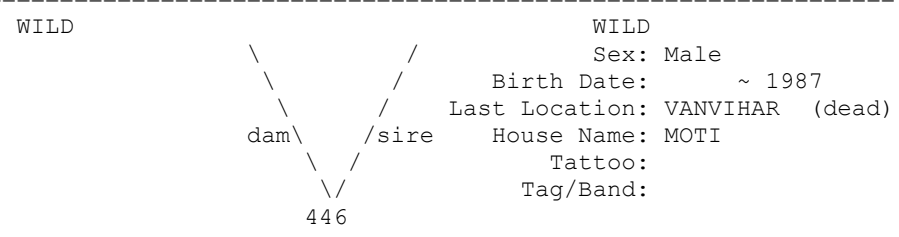

=====
 Taxon Name: PANTHERA TIGRIS Studbook Number: 447
 =====

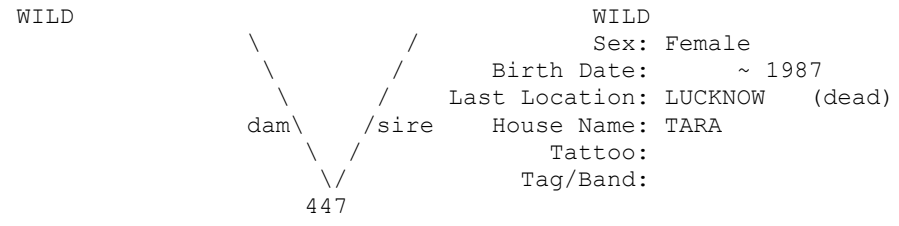

=====
 Taxon Name: PANTHERA TIGRIS Studbook Number: 448
 =====

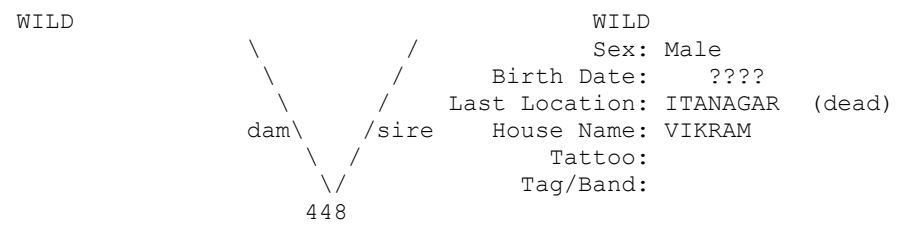

=====
 Taxon Name: PANTHERA TIGRIS Studbook Number: 452
 =====

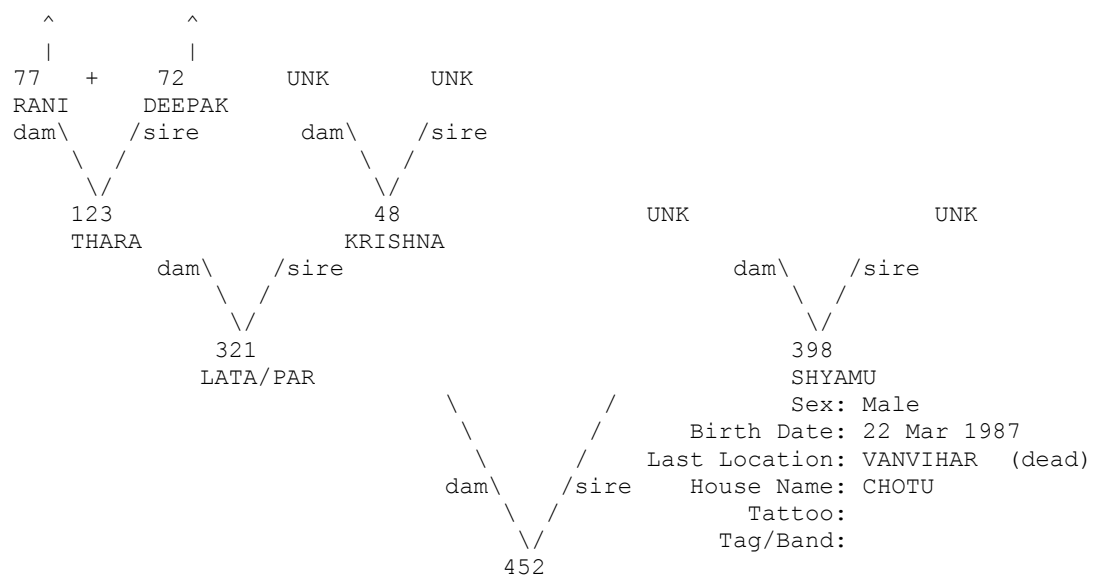

+ Wild-caught...
 ^ Pedigree continues beyond top of page...

=====
 Taxon Name: PANTHERA TIGRIS Studbook Number: 453
 =====

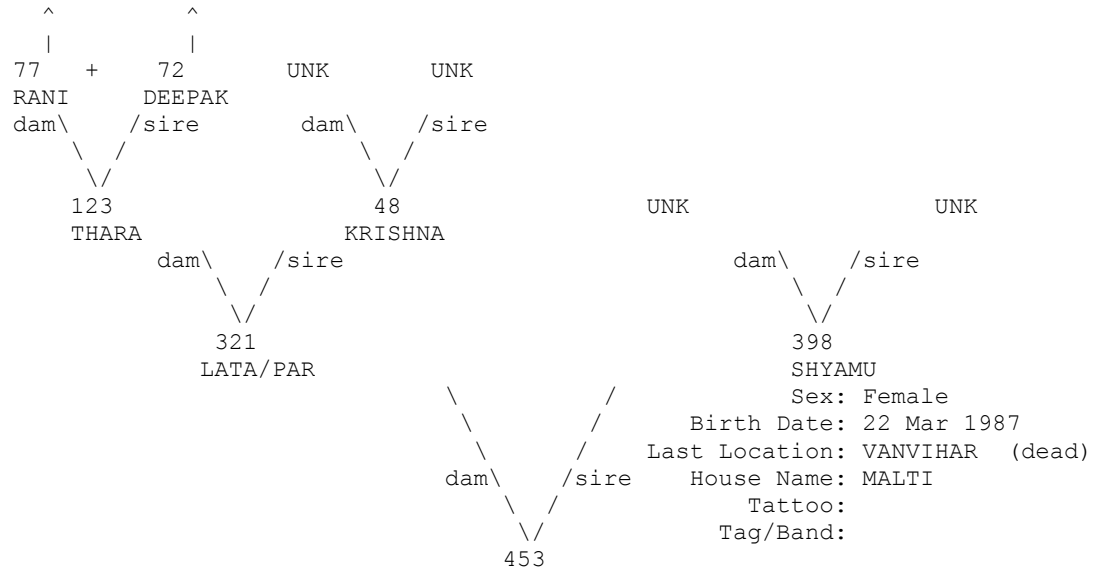

+ Wild-caught...
 ^ Pedigree continues beyond top of page...

=====
 Taxon Name: PANTHERA TIGRIS Studbook Number: 454
 =====

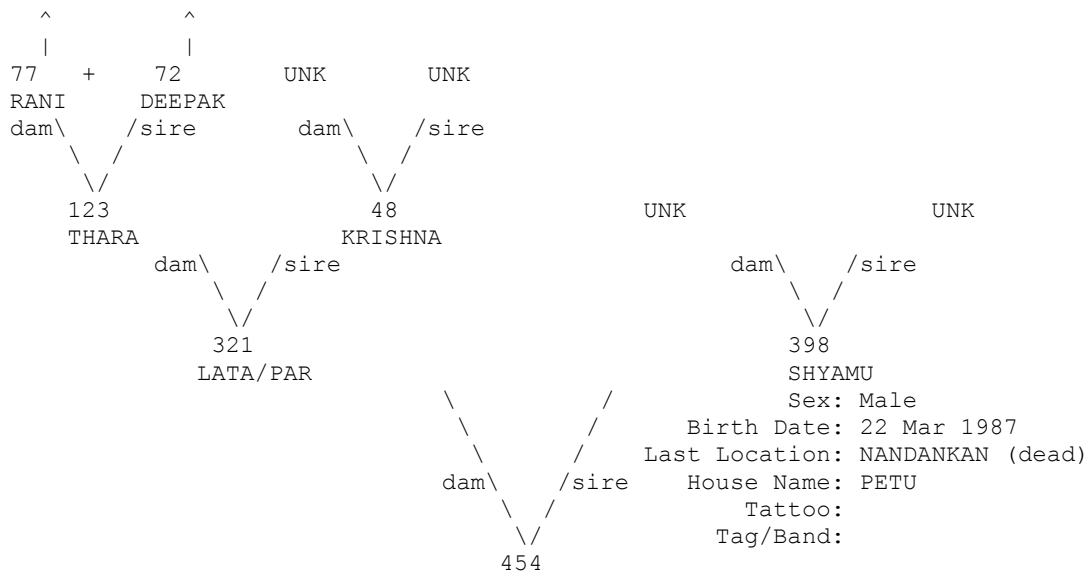

+ Wild-caught...
 ^ Pedigree continues beyond top of page...

=====
 Taxon Name: PANTHERA TIGRIS Studbook Number: 455
 =====

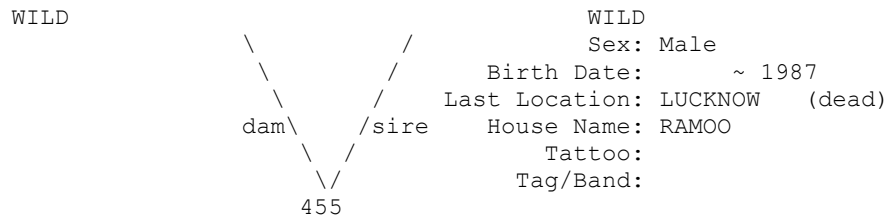

=====
 Taxon Name: PANTHERA TIGRIS Studbook Number: 456
 =====

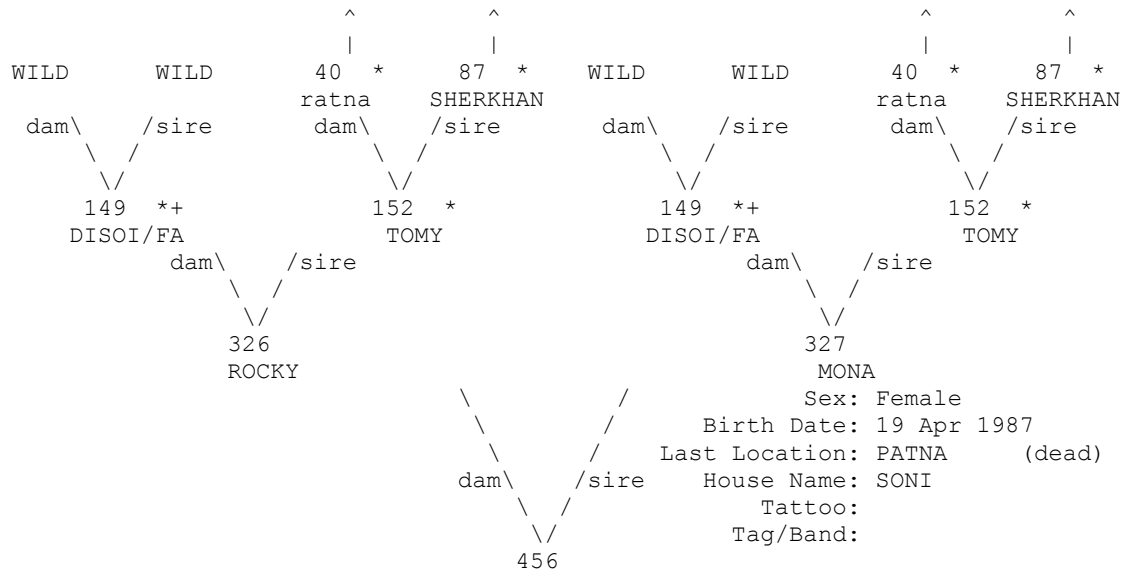

+ Wild-caught... * Appear more than once...
 ^ Pedigree continues beyond top of page...

=====
 Taxon Name: PANTHERA TIGRIS Studbook Number: 459
 =====

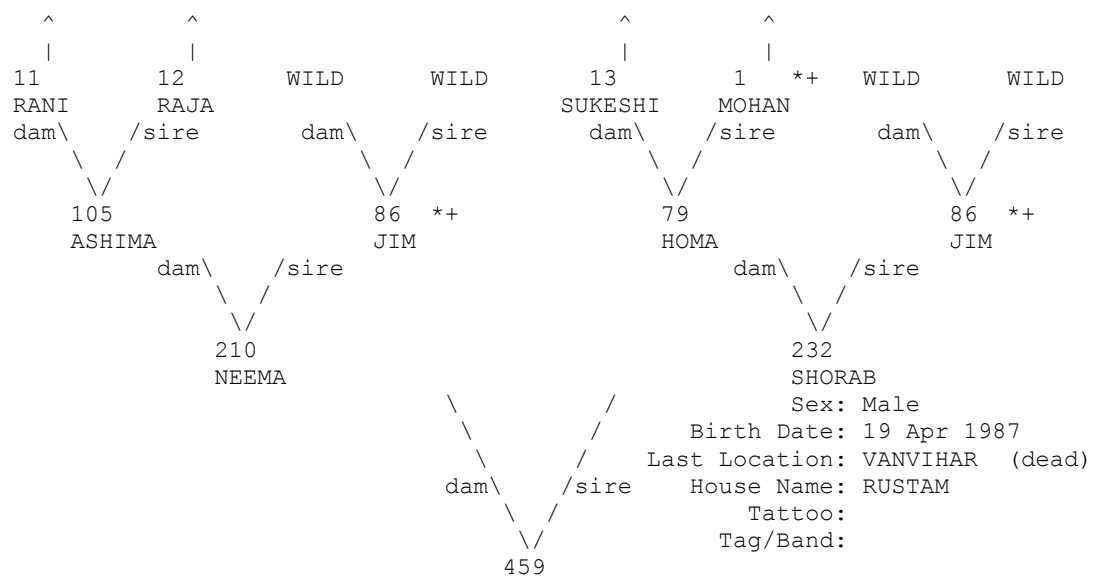

+ Wild-caught... * Appear more than once...
 ^ Pedigree continues beyond top of page...

=====
 Taxon Name: PANTHERA TIGRIS Studbook Number: 460
 =====

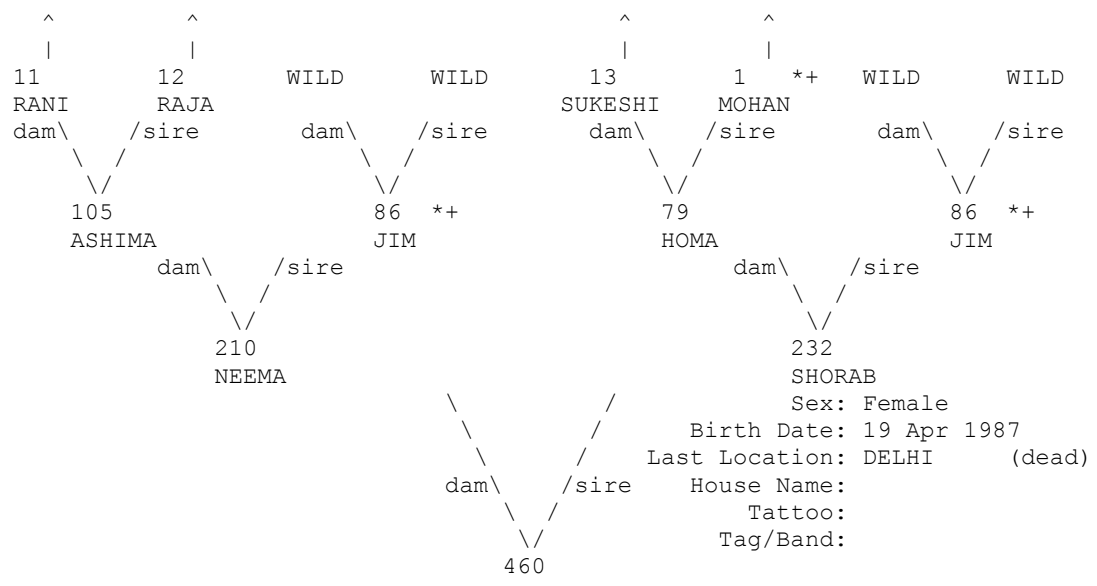

+ Wild-caught... * Appear more than once...
 ^ Pedigree continues beyond top of page...

=====
 Taxon Name: PANTHERA TIGRIS Studbook Number: 463
 =====

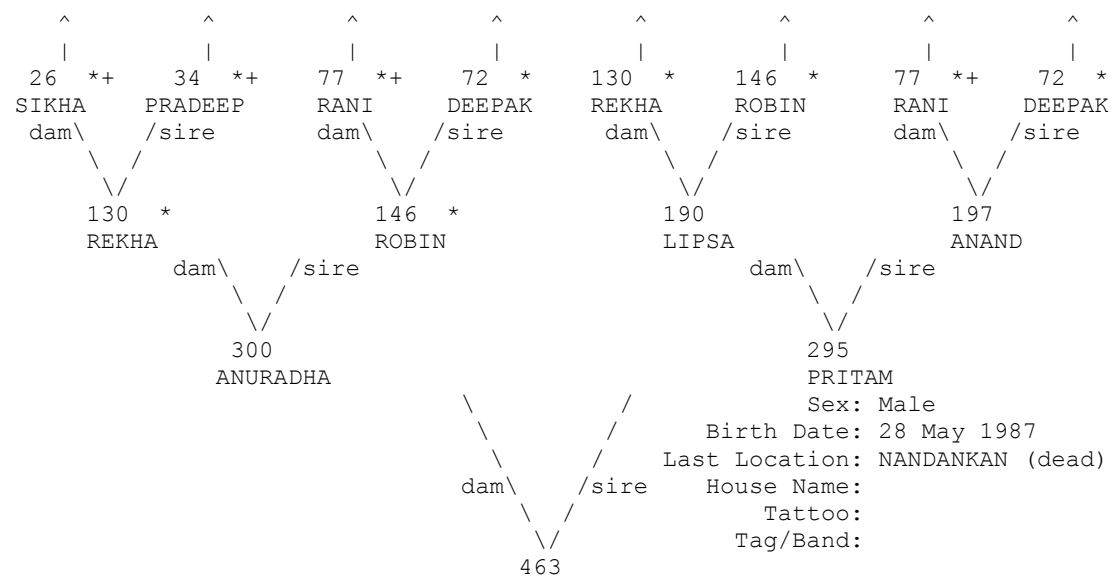

+ Wild-caught... * Appear more than once...
 ^ Pedigree continues beyond top of page...

=====
 Taxon Name: PANTHERA TIGRIS Studbook Number: 464
 =====

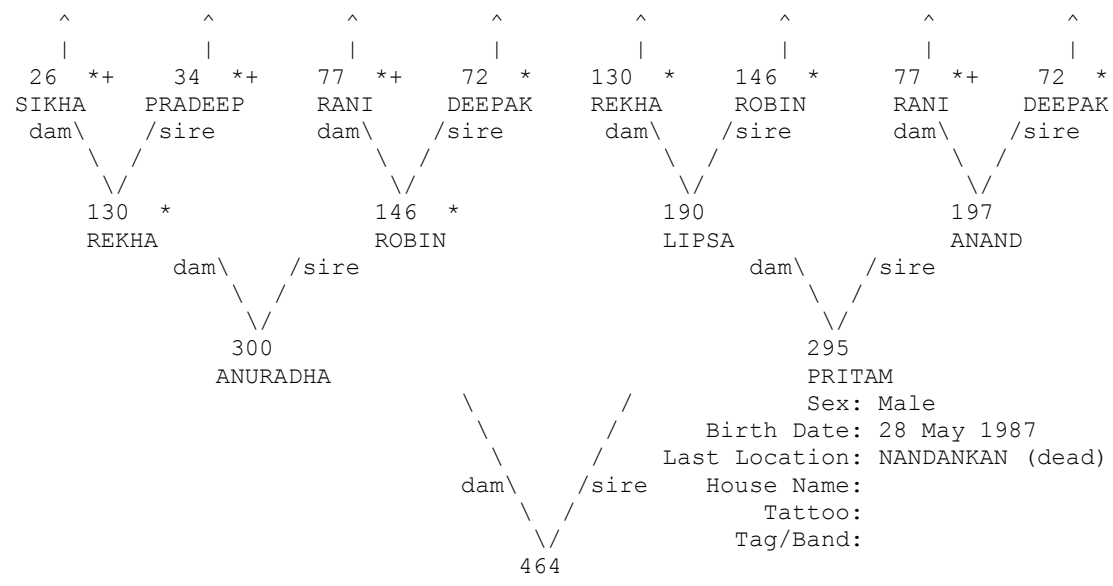

+ Wild-caught... * Appear more than once...
 ^ Pedigree continues beyond top of page...

=====
 Taxon Name: PANTHERA TIGRIS Studbook Number: 465
 =====

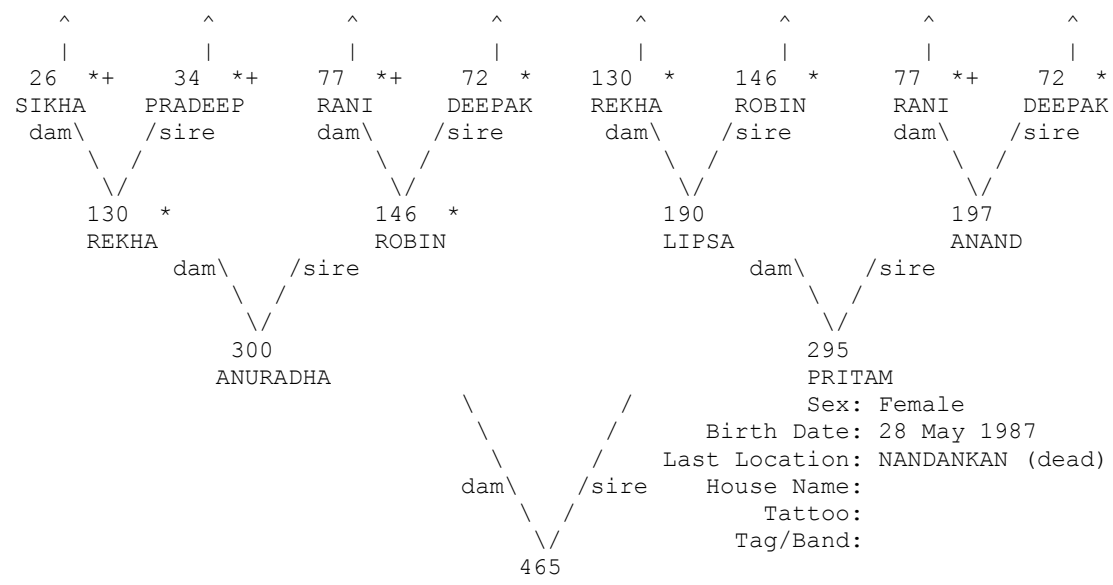

+ Wild-caught... * Appear more than once...
 ^ Pedigree continues beyond top of page...

=====
 Taxon Name: PANTHERA TIGRIS Studbook Number: 466
 =====

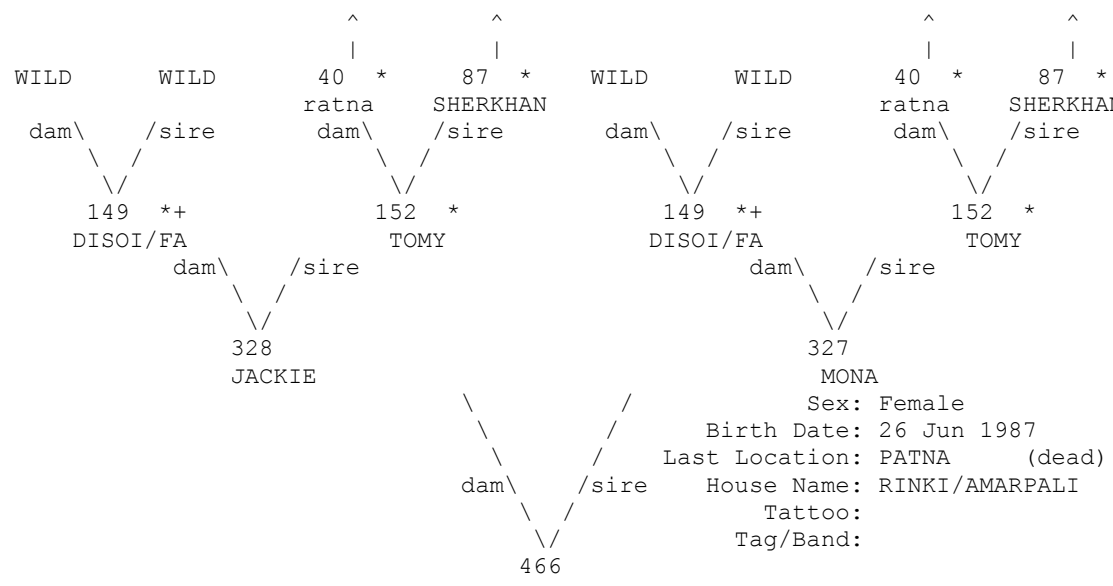

+ Wild-caught... * Appear more than once...
 ^ Pedigree continues beyond top of page...

=====
 Taxon Name: PANTHERA TIGRIS Studbook Number: 467
 =====

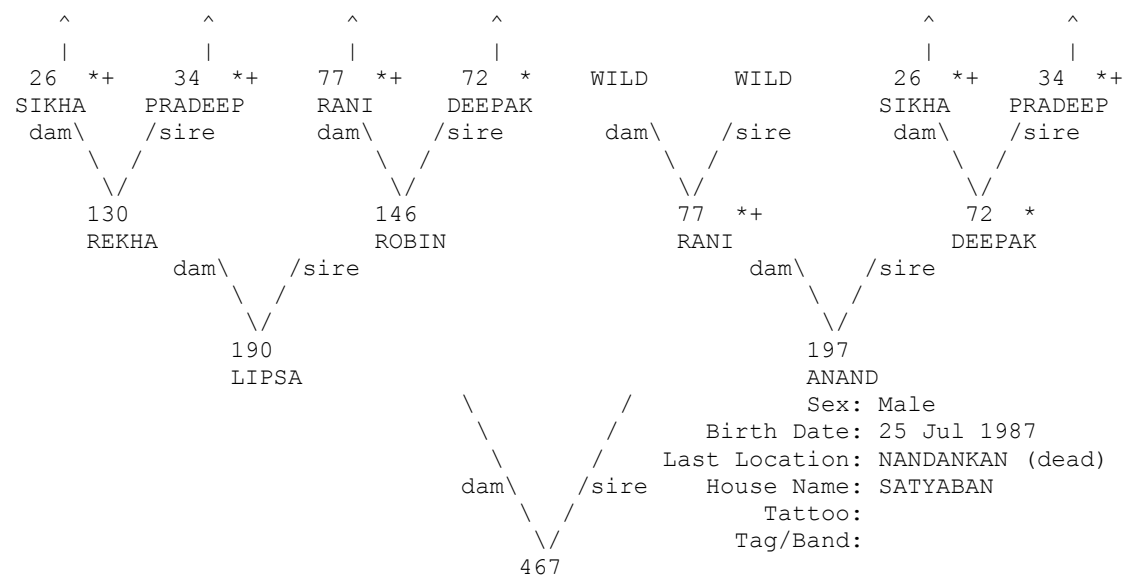

+ Wild-caught... * Appear more than once...
 ^ Pedigree continues beyond top of page...

=====
 Taxon Name: PANTHERA TIGRIS Studbook Number: 468
 =====

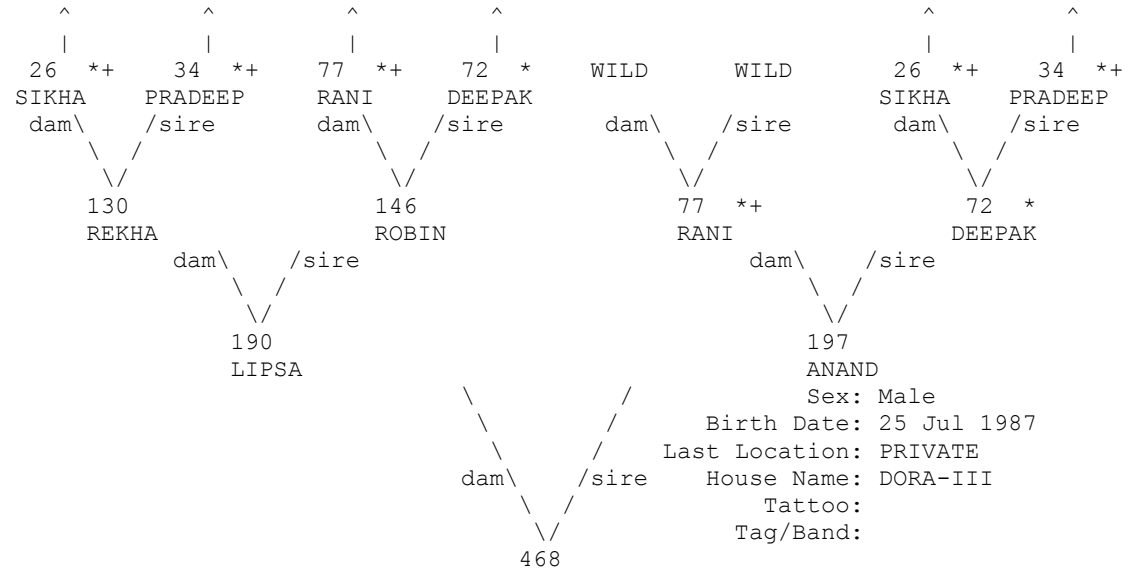

+ Wild-caught... * Appear more than once...
 ^ Pedigree continues beyond top of page...

=====
 Taxon Name: PANTHERA TIGRIS Studbook Number: 469
 =====

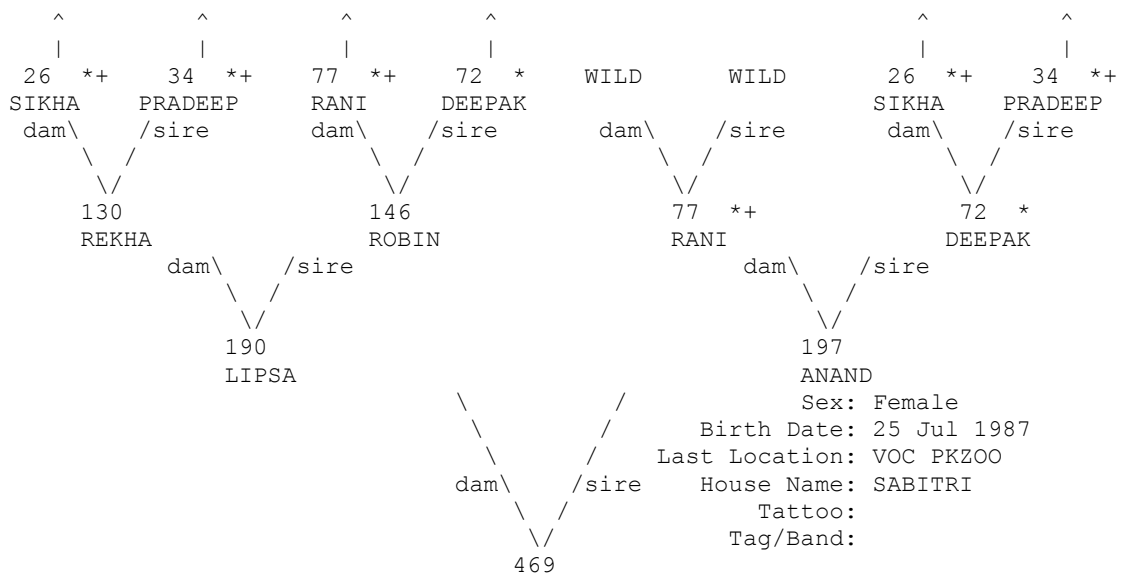

+ Wild-caught... * Appear more than once...
 ^ Pedigree continues beyond top of page...

=====
 Taxon Name: PANTHERA TIGRIS Studbook Number: 470
 =====

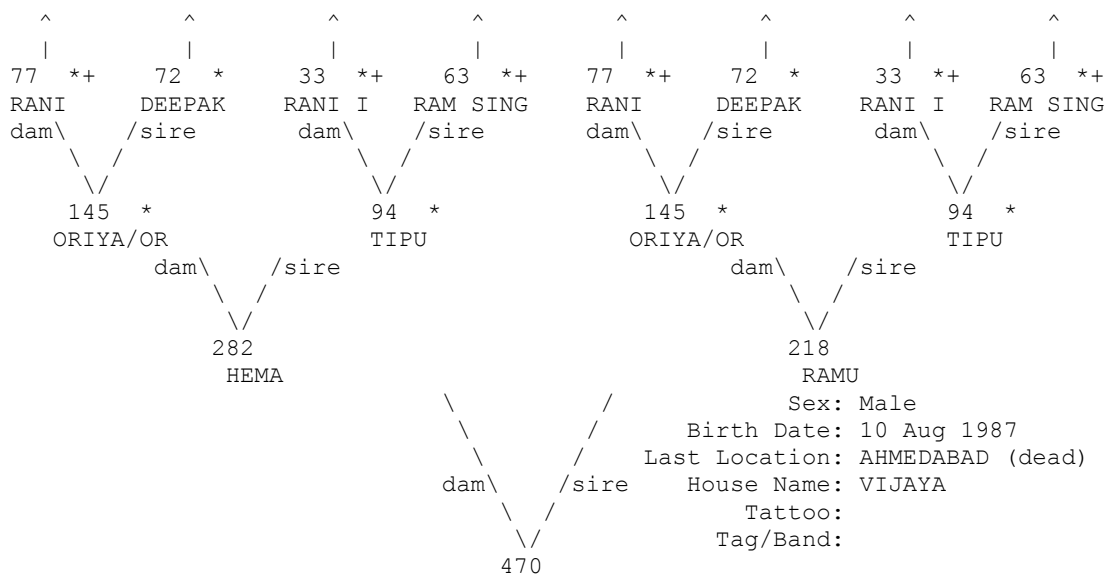

+ Wild-caught... * Appear more than once...
 ^ Pedigree continues beyond top of page...

=====
 Taxon Name: PANTHERA TIGRIS Studbook Number: 471
 =====

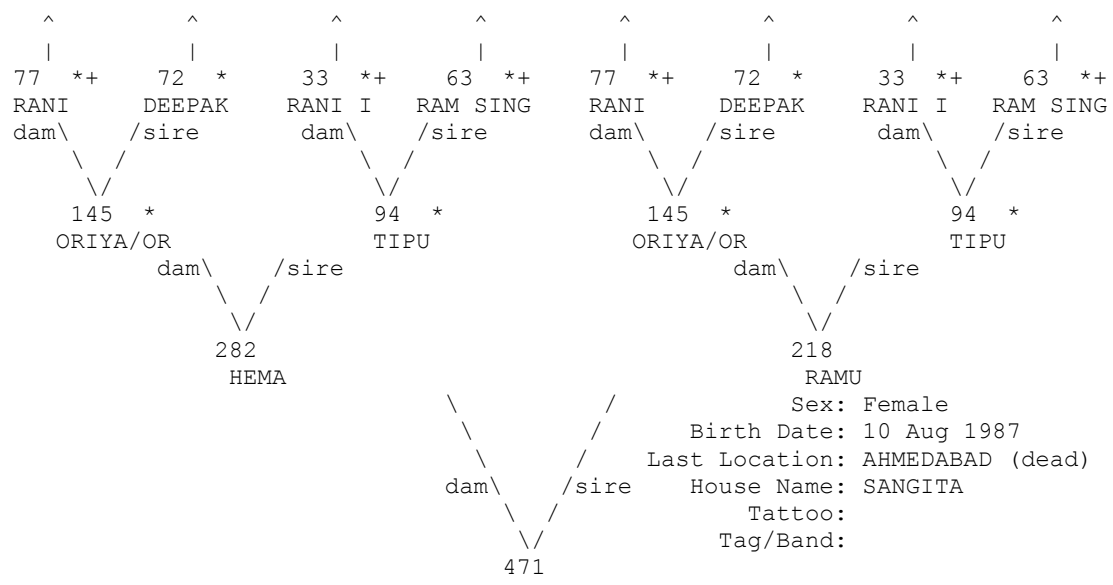

+ Wild-caught... * Appear more than once...
 ^ Pedigree continues beyond top of page...

=====
 Taxon Name: PANTHERA TIGRIS Studbook Number: 472
 =====

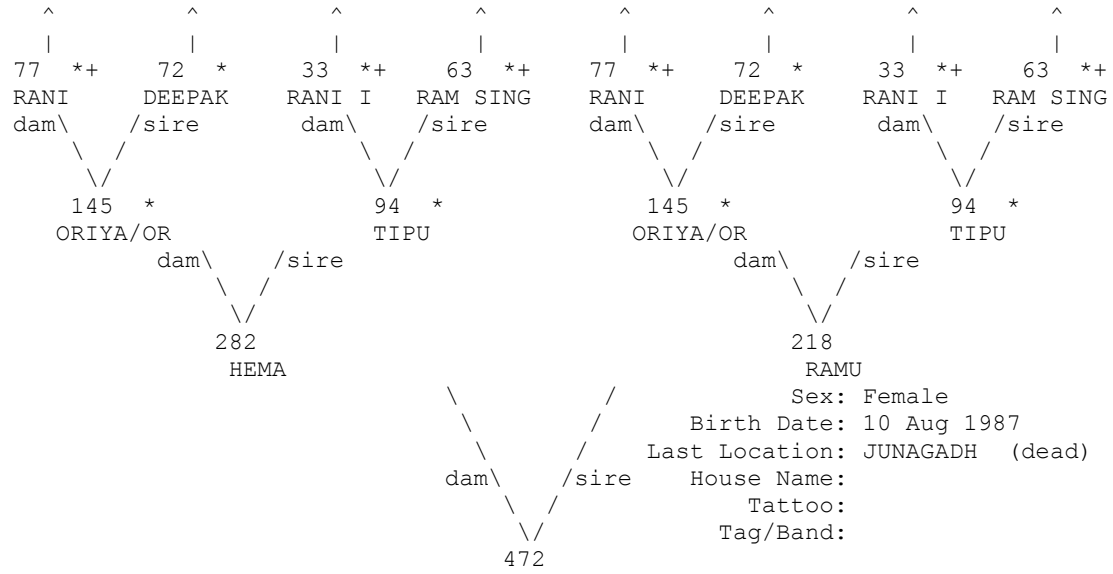

+ Wild-caught... * Appear more than once...
 ^ Pedigree continues beyond top of page...

=====
 Taxon Name: PANTHERA TIGRIS Studbook Number: 473
 =====

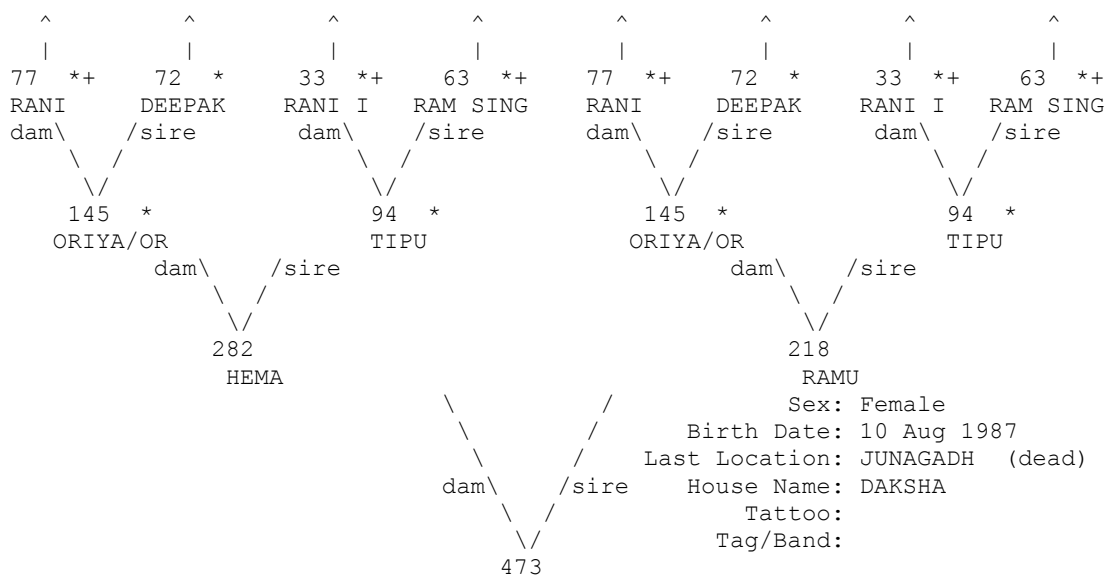

+ Wild-caught... * Appear more than once...
 ^ Pedigree continues beyond top of page...

=====
 Taxon Name: PANTHERA TIGRIS Studbook Number: 474
 =====

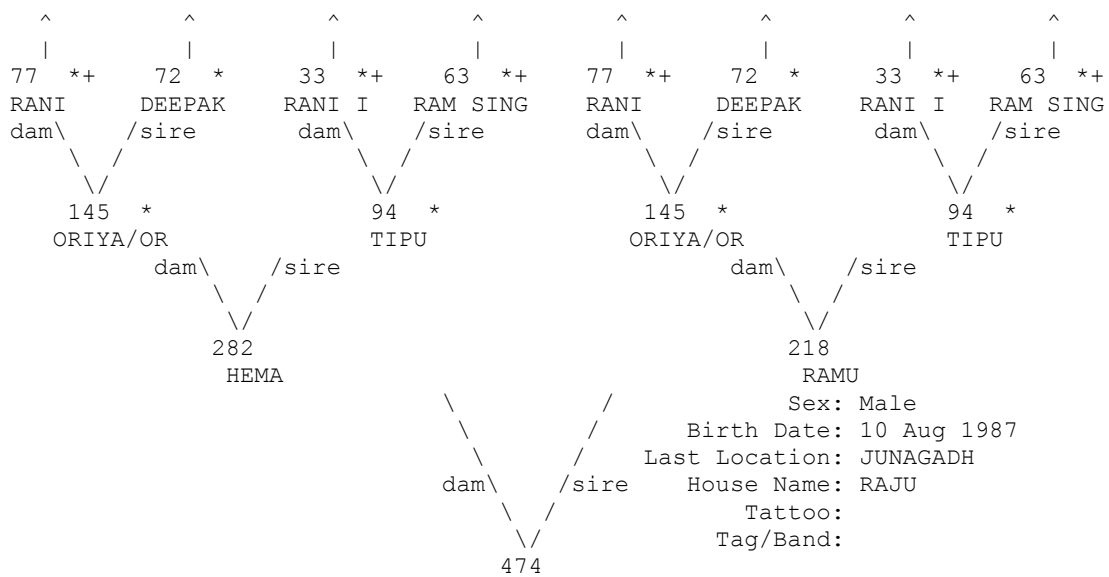

+ Wild-caught... * Appear more than once...
 ^ Pedigree continues beyond top of page...

=====
 Taxon Name: PANTHERA TIGRIS Studbook Number: 475
 =====

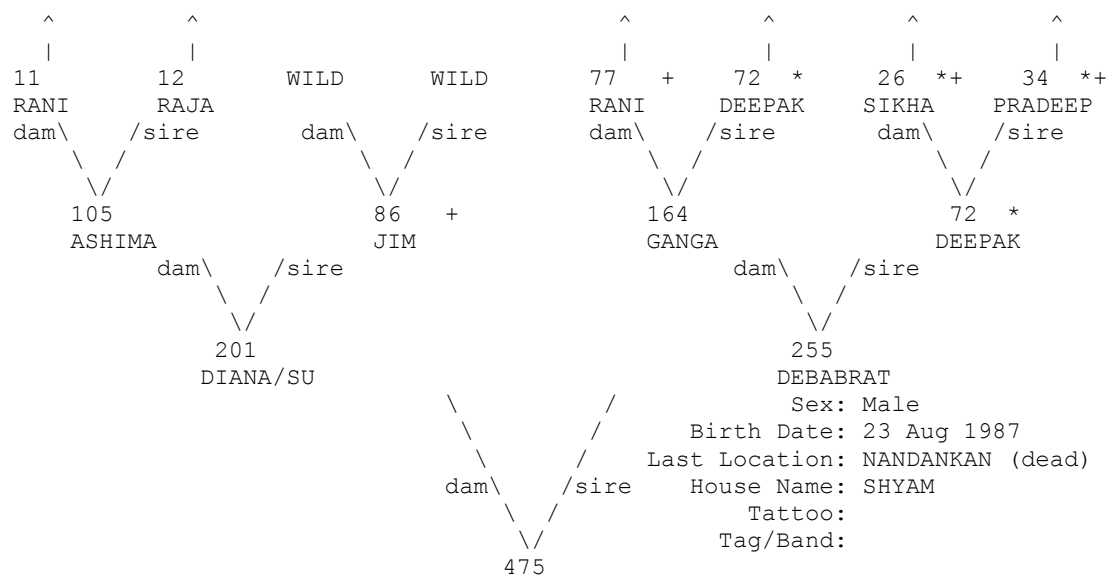

+ Wild-caught... * Appear more than once...
 ^ Pedigree continues beyond top of page...

=====
 Taxon Name: PANTHERA TIGRIS Studbook Number: 476
 =====

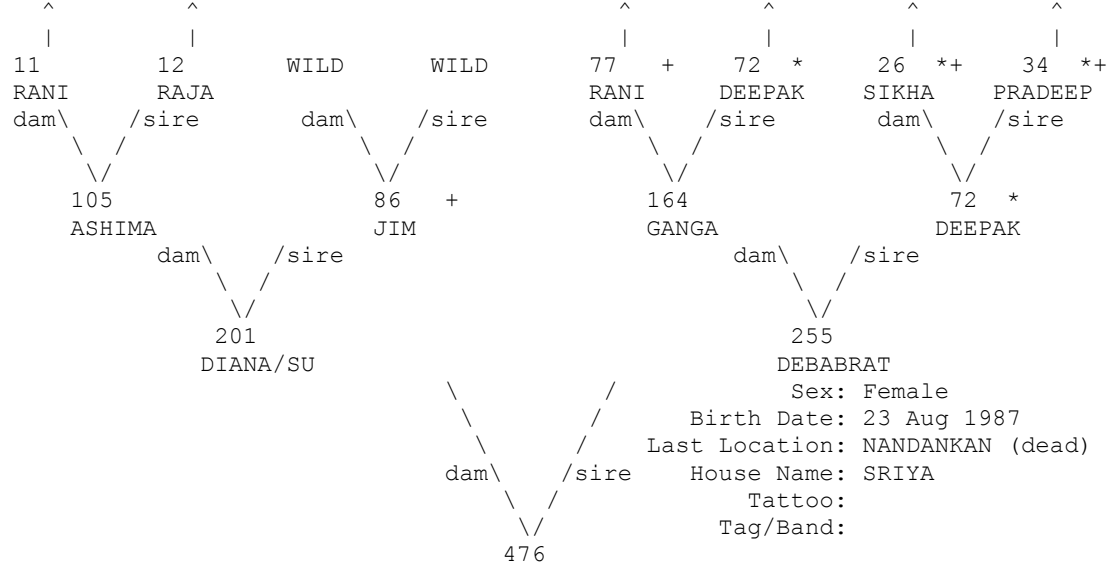

+ Wild-caught... * Appear more than once...
 ^ Pedigree continues beyond top of page...

```

=====
Taxon Name: PANTHERA TIGRIS                               Studbook Number: 477
=====
UNK                                                         UNK
                                                           Sex: Male
                                                           Birth Date: 25 Sep 1987
                                                           Last Location: TRIVANDRU (dead)
                                                           House Name:
                                                           Tattoo:
                                                           Tag/Band:
    \      /
   dam\  /sire
      \  /
       477

```

```

=====
Taxon Name: PANTHERA TIGRIS                               Studbook Number: 478
=====
UNK                                                         UNK
                                                           Sex: Male
                                                           Birth Date: 25 Sep 1987
                                                           Last Location: TRIVANDRU (dead)
                                                           House Name:
                                                           Tattoo:
                                                           Tag/Band:
    \      /
   dam\  /sire
      \  /
       478

```

```

=====
Taxon Name: PANTHERA TIGRIS                               Studbook Number: 479
=====
UNK                                                         UNK
                                                           Sex: Female
                                                           Birth Date: 25 Sep 1987
                                                           Last Location: TRIVANDRU (dead)
                                                           House Name:
                                                           Tattoo:
                                                           Tag/Band:
    \      /
   dam\  /sire
      \  /
       479

```

```

=====
Taxon Name: PANTHERA TIGRIS                               Studbook Number: 480
=====
UNK dam\  /sire  UNK dam\  /sire  UNK dam\  /sire  UNK dam\  /sire
  47 *          48 *          47 *          48 *
  RADHA        KRISHNA
    dam\  /sire
      \  /
       170
      SATYABHA
    \      /
   dam\  /sire
      \  /
       158
      RAJA
    Sex: Female
    Birth Date: 16 Oct 1987
    Last Location: MYSORE (dead)
    House Name: DIVYA
    Tattoo:
    Tag/Band:
    \      /
   dam\  /sire
      \  /
       480

```

* Appear more than once...

=====
 Taxon Name: PANTHERA TIGRIS Studbook Number: 481
 =====

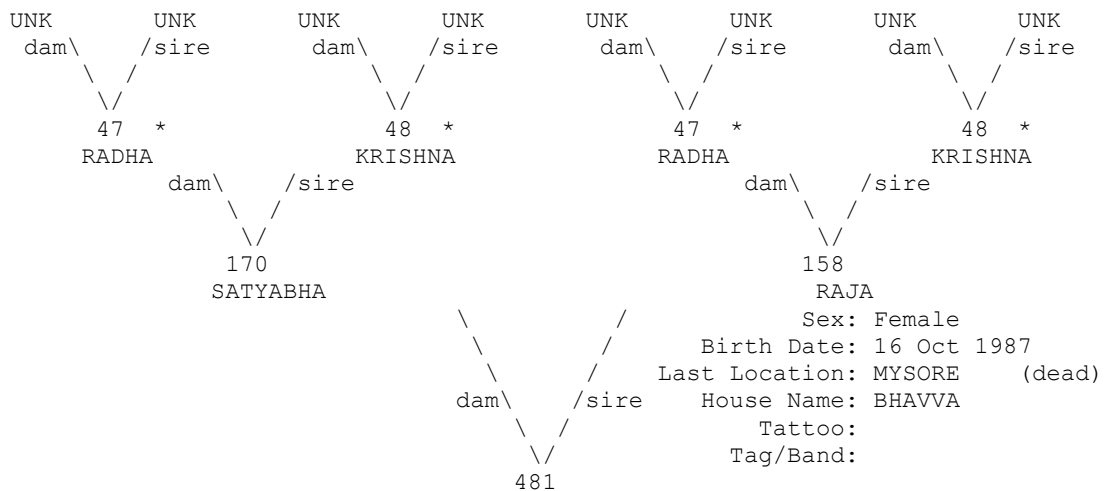

* Appear more than once...

=====
 Taxon Name: PANTHERA TIGRIS Studbook Number: 482
 =====

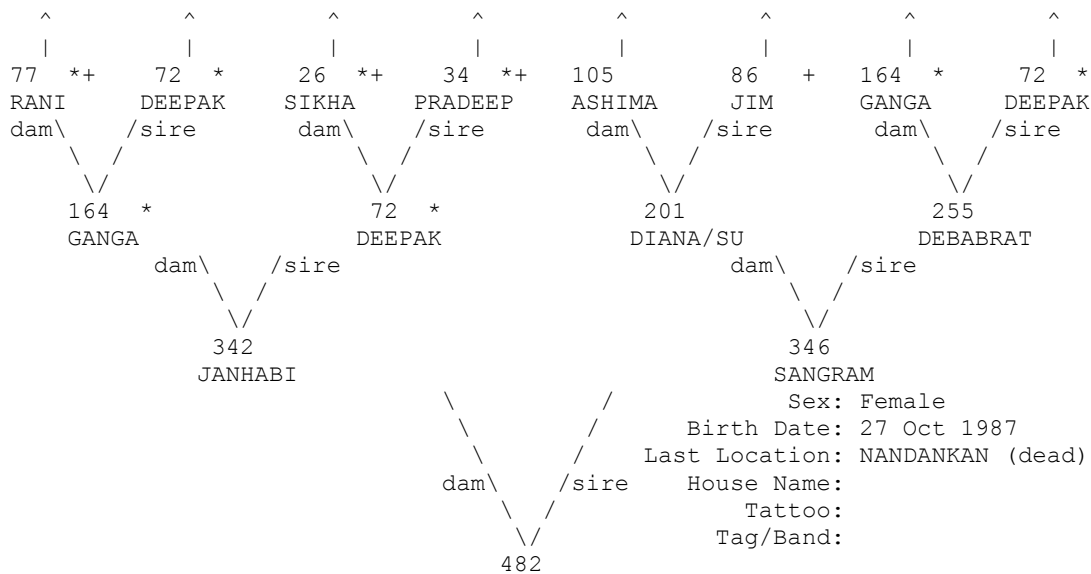

+ Wild-caught... * Appear more than once...

^ Pedigree continues beyond top of page...

=====
 Taxon Name: PANTHERA TIGRIS Studbook Number: 483
 =====

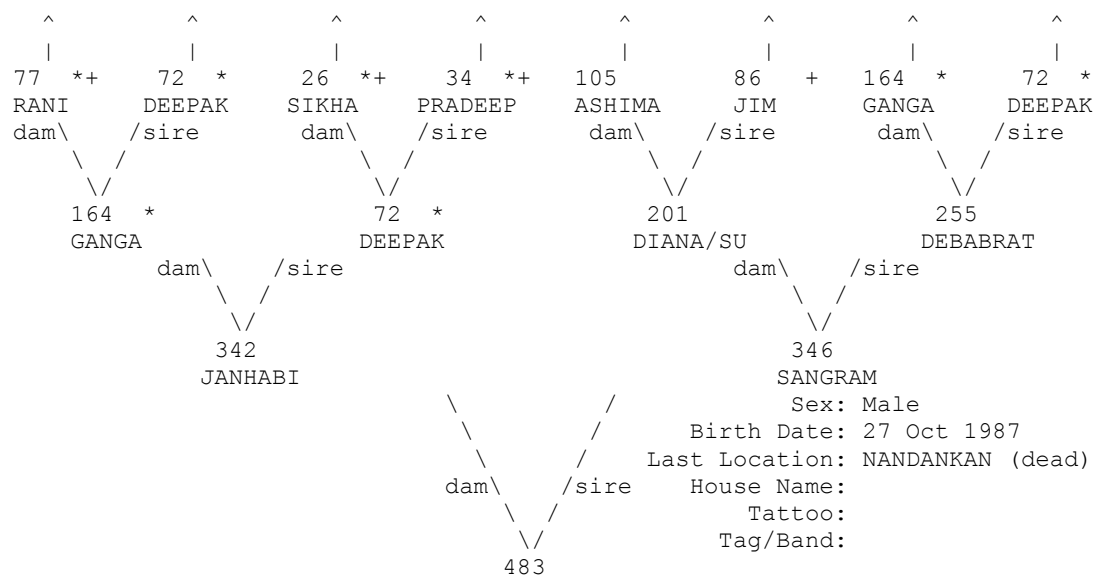

+ Wild-caught... * Appear more than once...
 ^ Pedigree continues beyond top of page...

=====
 Taxon Name: PANTHERA TIGRIS Studbook Number: 484
 =====

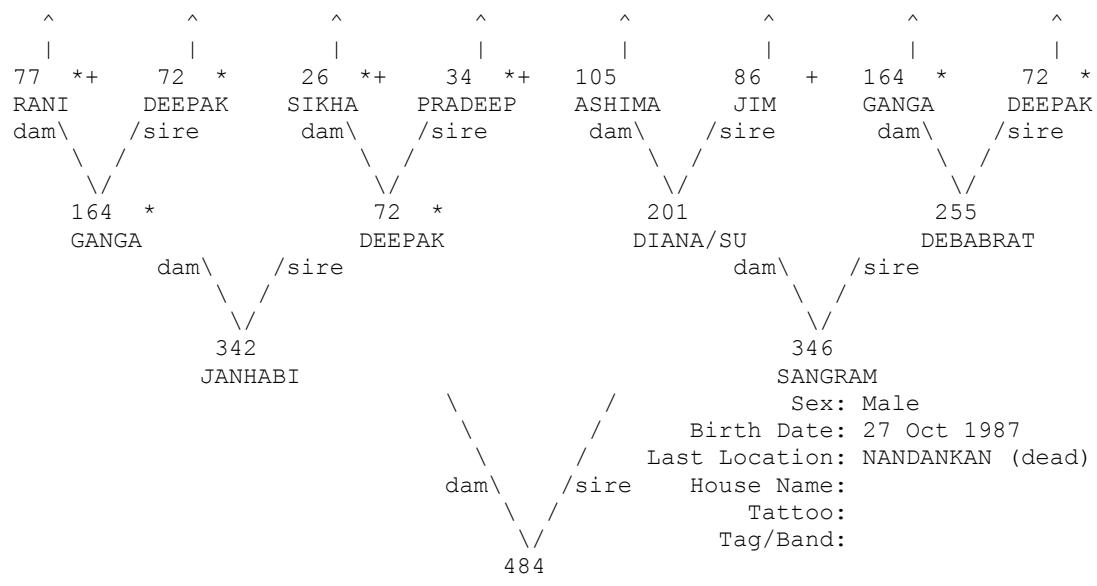

+ Wild-caught... * Appear more than once...
 ^ Pedigree continues beyond top of page...

=====
 Taxon Name: PANTHERA TIGRIS Studbook Number: 485
 =====

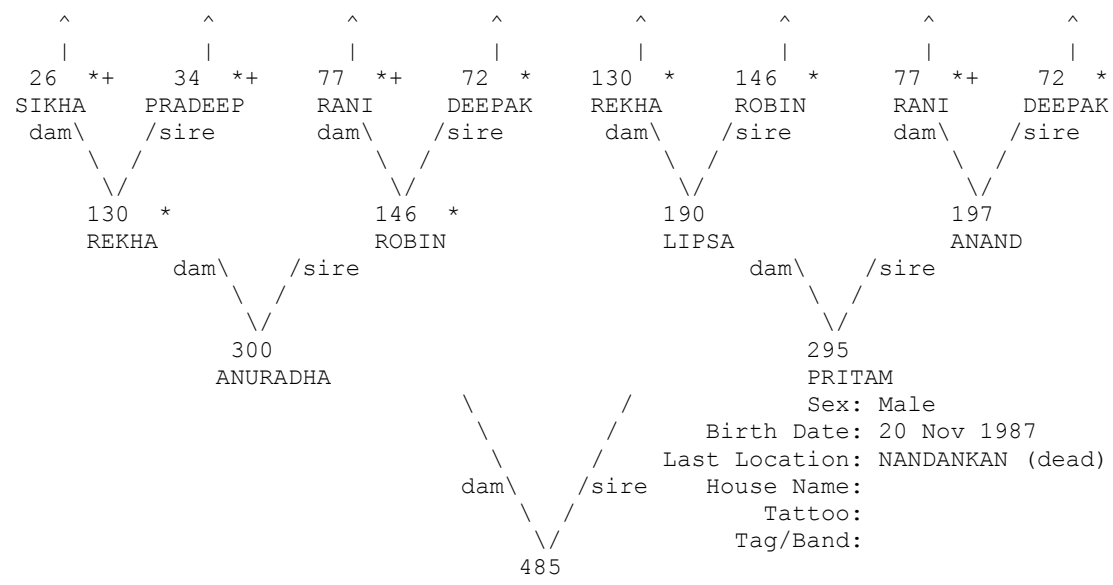

+ Wild-caught... * Appear more than once...
 ^ Pedigree continues beyond top of page...

=====
 Taxon Name: PANTHERA TIGRIS Studbook Number: 486
 =====

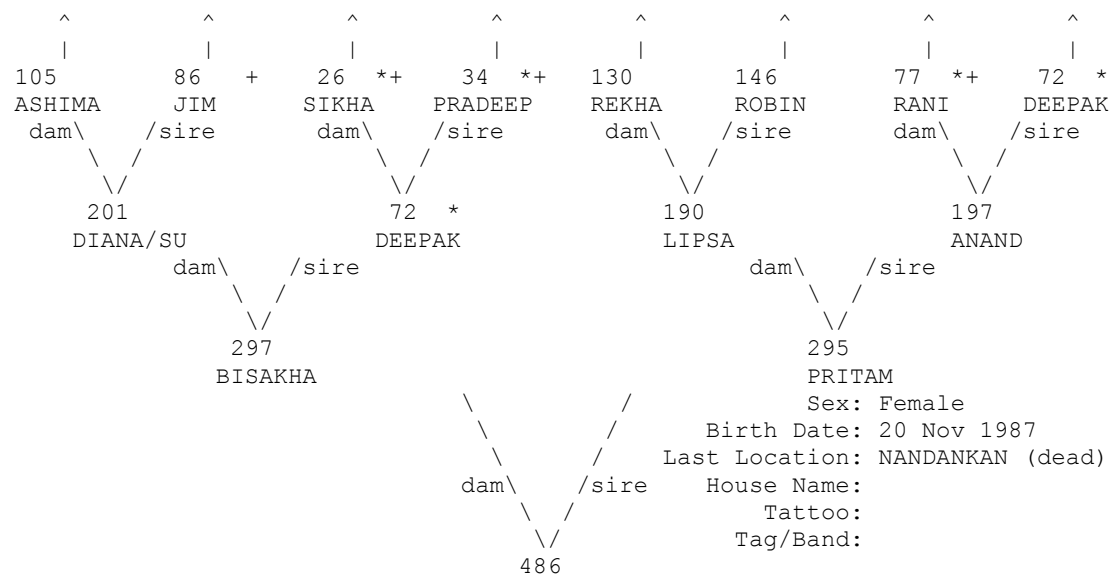

+ Wild-caught... * Appear more than once...
 ^ Pedigree continues beyond top of page...

=====
 Taxon Name: PANTHERA TIGRIS Studbook Number: 487
 =====

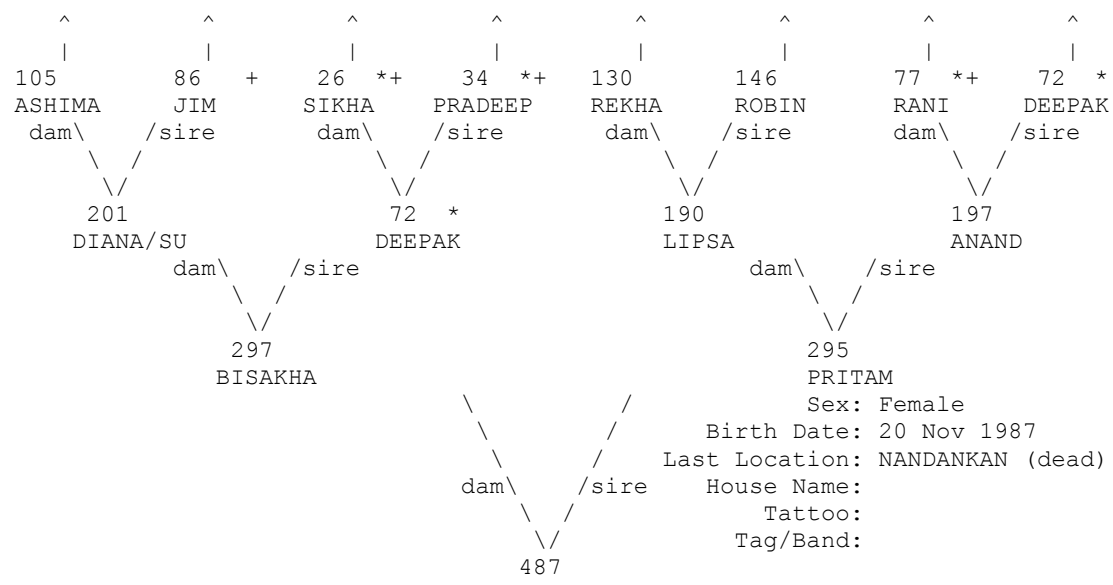

+ Wild-caught... * Appear more than once...
 ^ Pedigree continues beyond top of page...

=====
 Taxon Name: PANTHERA TIGRIS Studbook Number: 488
 =====

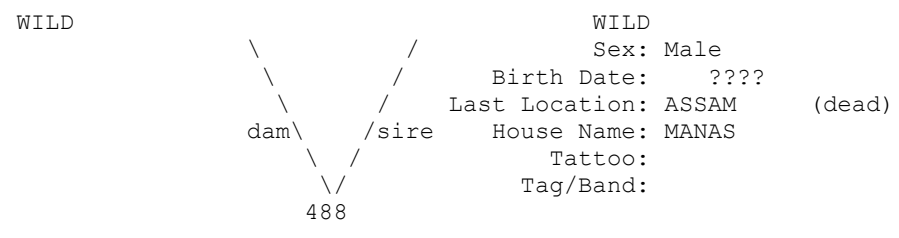

=====
 Taxon Name: PANTHERA TIGRIS Studbook Number: 489
 =====

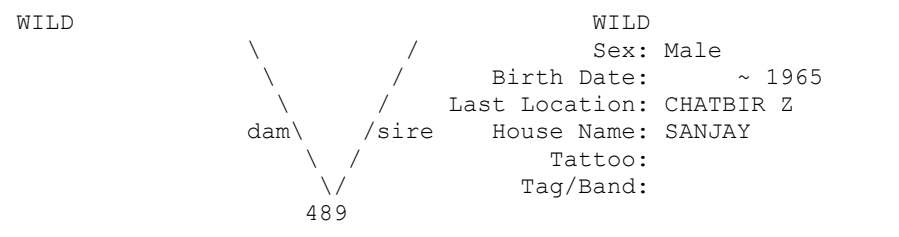

=====
 Taxon Name: PANTHERA TIGRIS Studbook Number: 490
 =====

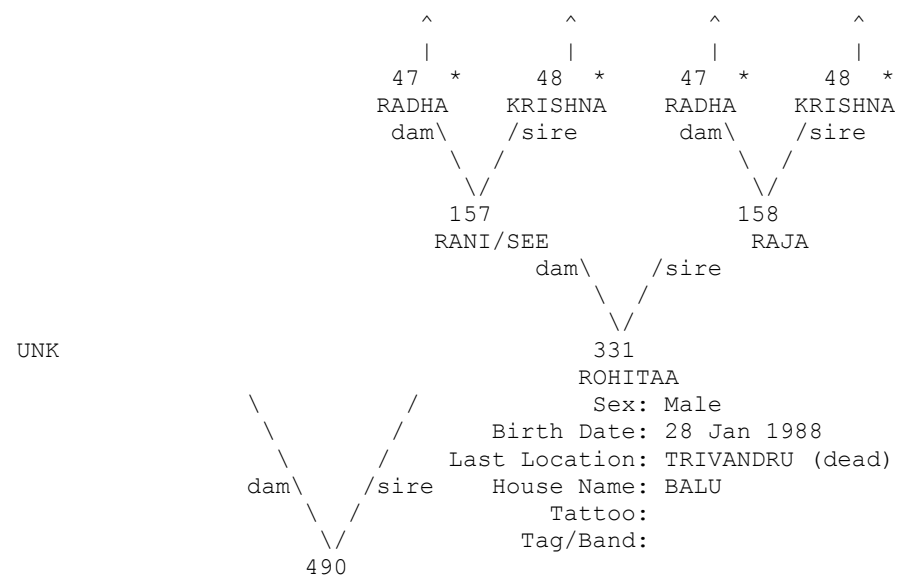

* Appear more than once...
 ^ Pedigree continues beyond top of page...

=====
 Taxon Name: PANTHERA TIGRIS Studbook Number: 491
 =====

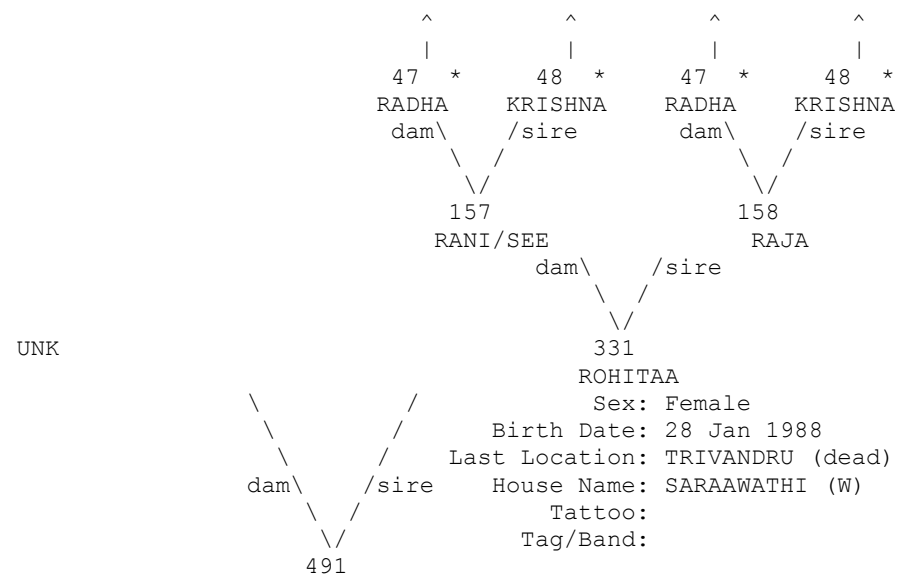

* Appear more than once...
 ^ Pedigree continues beyond top of page...

=====
 Taxon Name: PANTHERA TIGRIS Studbook Number: 492
 =====

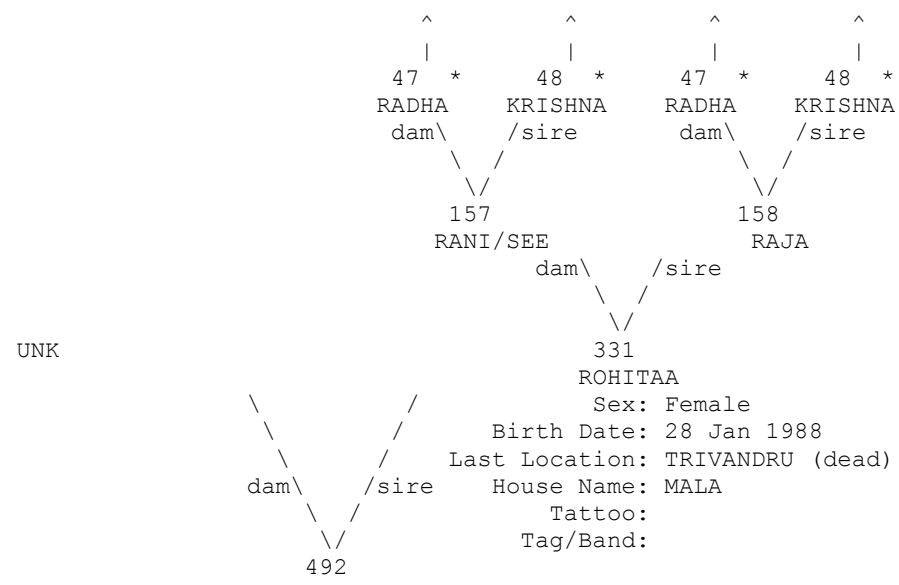

* Appear more than once...
 ^ Pedigree continues beyond top of page...

=====
 Taxon Name: PANTHERA TIGRIS Studbook Number: 493
 =====

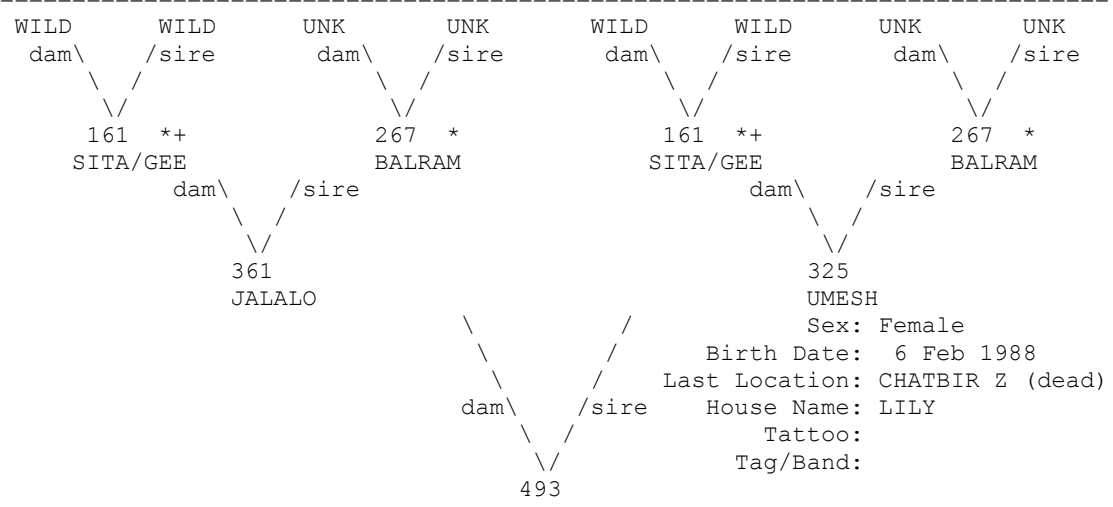

+ Wild-caught... * Appear more than once...

=====
 Taxon Name: PANTHERA TIGRIS Studbook Number: 494
 =====

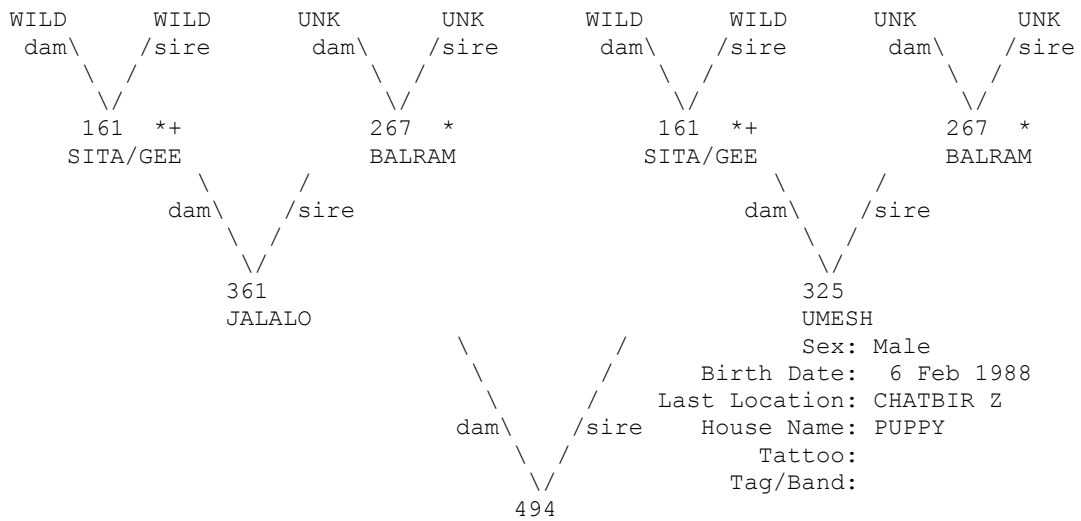

+ Wild-caught... * Appear more than once...

=====
 Taxon Name: PANTHERA TIGRIS Studbook Number: 495
 =====

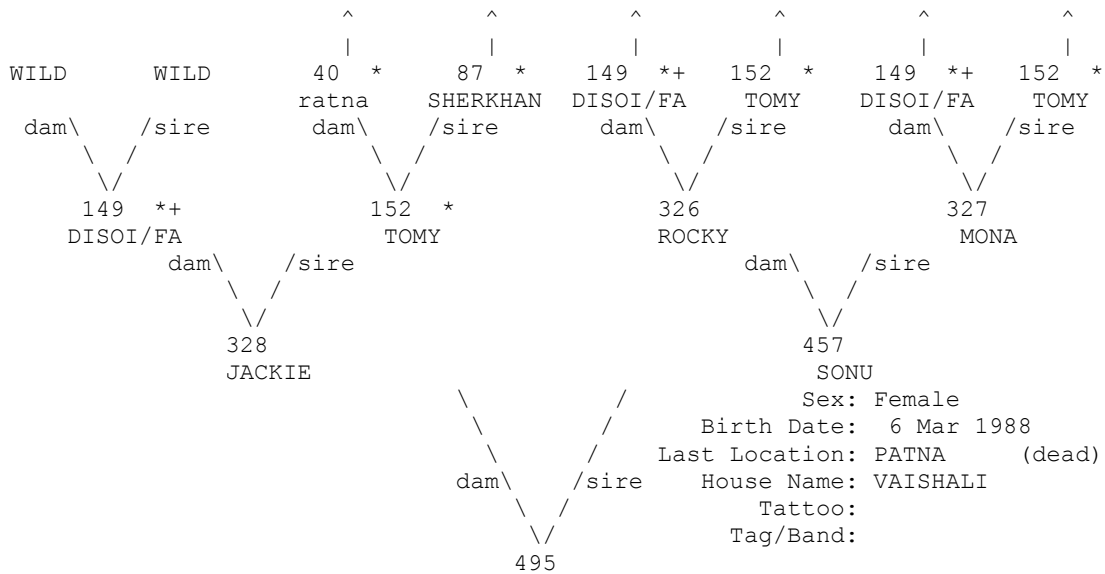

+ Wild-caught... * Appear more than once...

^ Pedigree continues beyond top of page...

=====
 Taxon Name: PANTHERA TIGRIS Studbook Number: 496
 =====

WILD

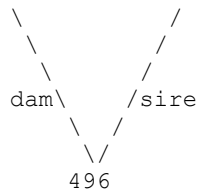

WILD
 Sex: Male
 Birth Date: ~ 1978
 Last Location: SEPAHIJAL (dead)
 House Name: RAJKUMAR/RAJA
 Tattoo:
 Tag/Band:

=====
 Taxon Name: PANTHERA TIGRIS Studbook Number: 497
 =====

UNK

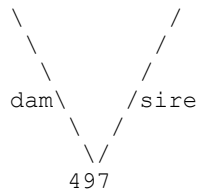

UNK
 Sex: Male
 Birth Date: 23 Mar 1988
 Last Location: TRICHUR (dead)
 House Name:
 Tattoo:
 Tag/Band:

=====
 Taxon Name: PANTHERA TIGRIS Studbook Number: 498
 =====

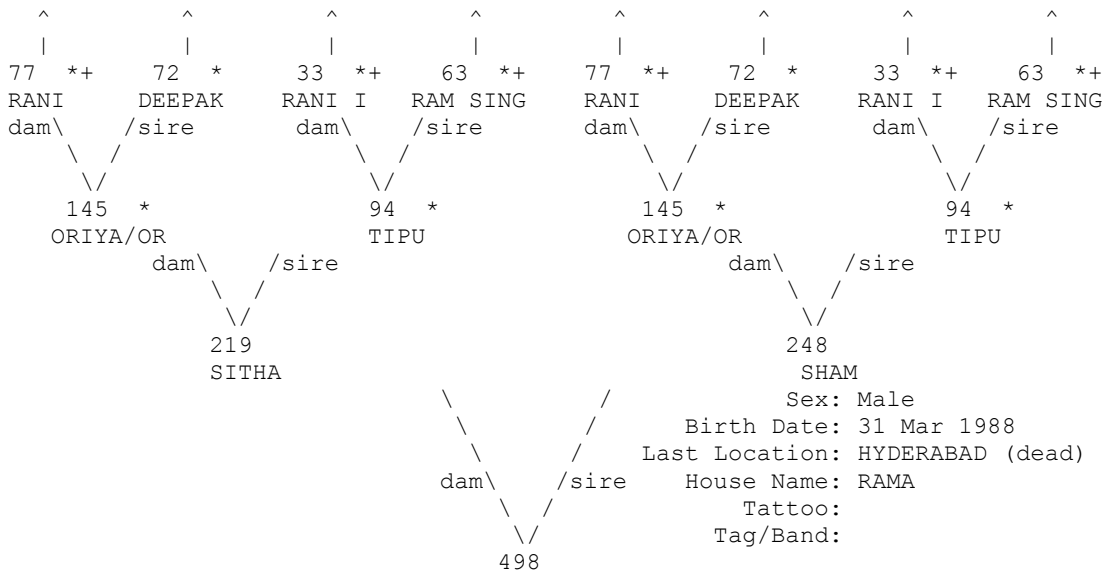

Sex: Male
 Birth Date: 31 Mar 1988
 Last Location: HYDERABAD (dead)
 House Name: RAMA
 Tattoo:
 Tag/Band:

+ Wild-caught... * Appear more than once...
 ^ Pedigree continues beyond top of page...

=====
 Taxon Name: PANTHERA TIGRIS Studbook Number: 499
 =====

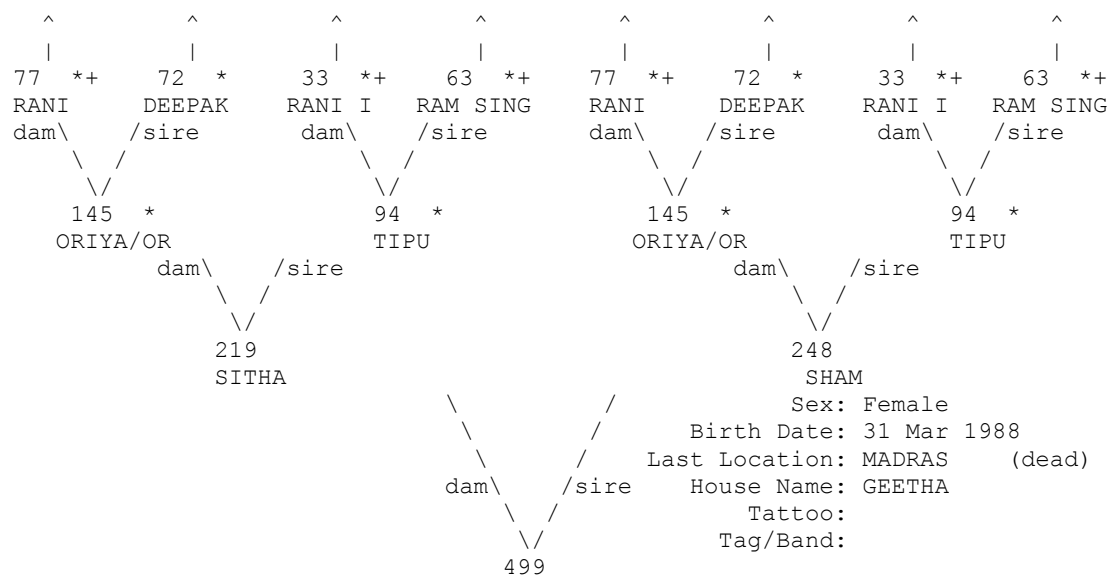

+ Wild-caught... * Appear more than once...
 ^ Pedigree continues beyond top of page...

=====
 Taxon Name: PANTHERA TIGRIS Studbook Number: 500
 =====

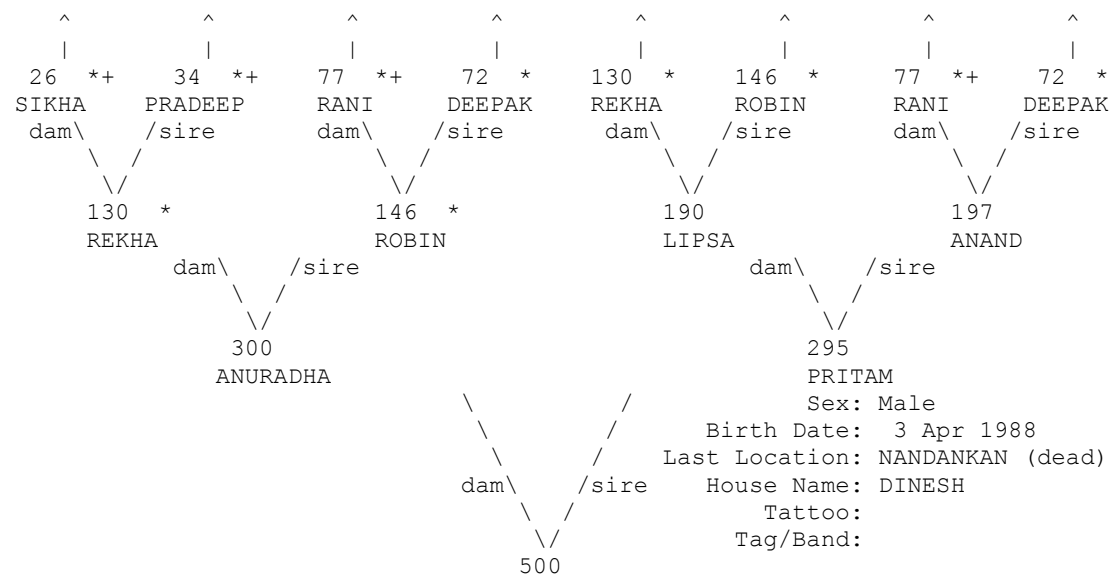

+ Wild-caught... * Appear more than once...
 ^ Pedigree continues beyond top of page...

=====
 Taxon Name: PANTHERA TIGRIS Studbook Number: 501
 =====

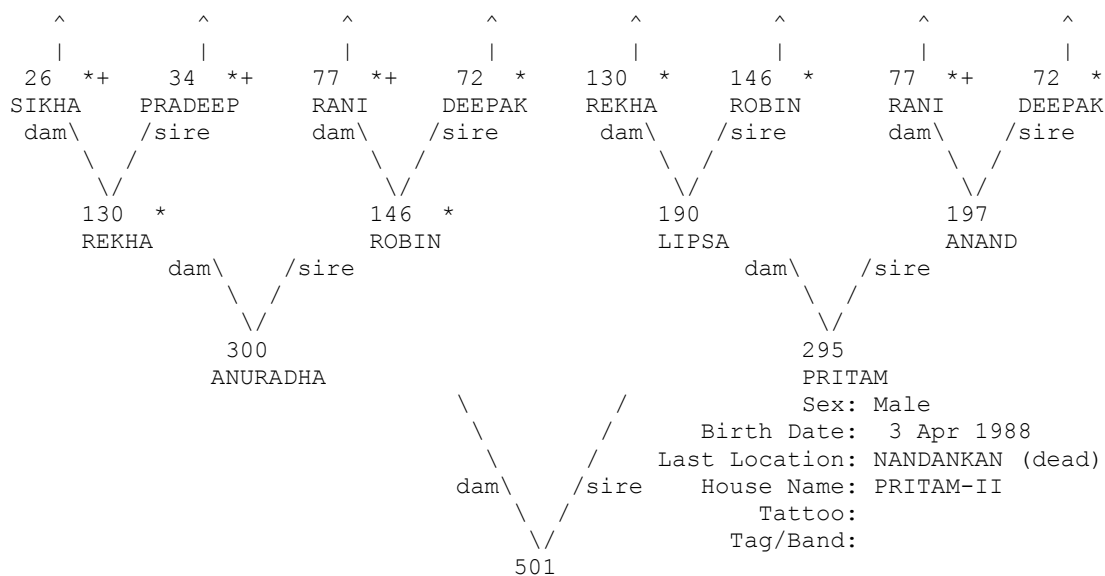

+ Wild-caught... * Appear more than once...
 ^ Pedigree continues beyond top of page...

=====
 Taxon Name: PANTHERA TIGRIS Studbook Number: 502
 =====

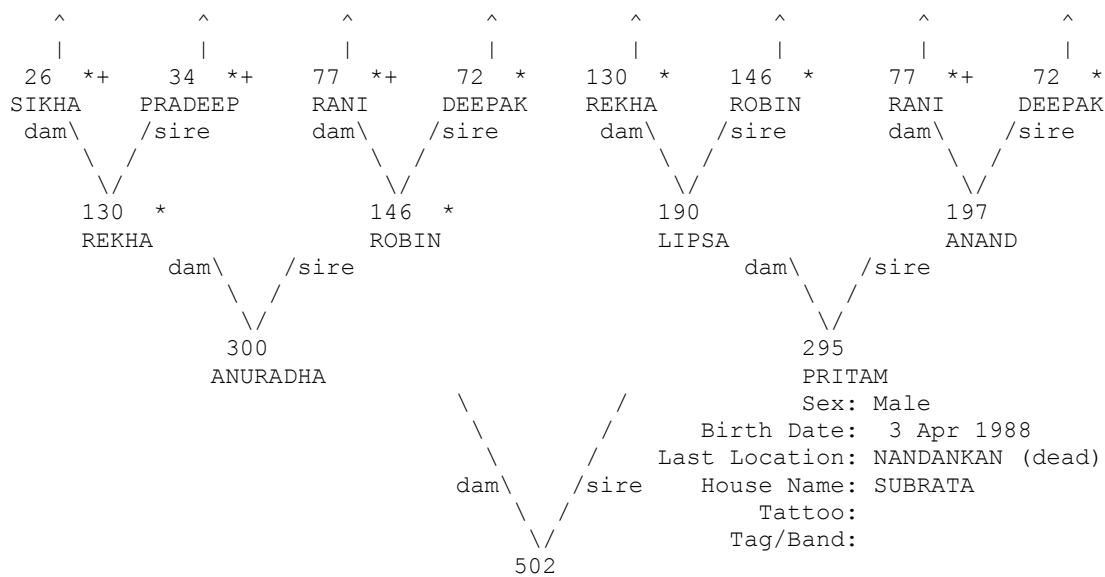

+ Wild-caught... * Appear more than once...
 ^ Pedigree continues beyond top of page...

=====
 Taxon Name: PANTHERA TIGRIS Studbook Number: 503
 =====

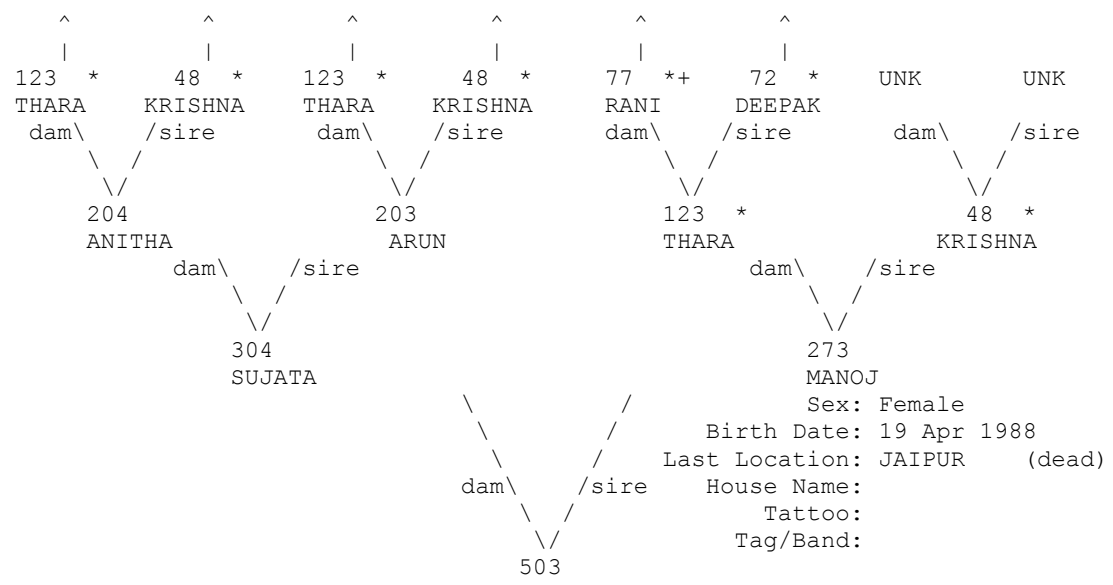

+ Wild-caught... * Appear more than once...
 ^ Pedigree continues beyond top of page...

=====
 Taxon Name: PANTHERA TIGRIS Studbook Number: 504
 =====

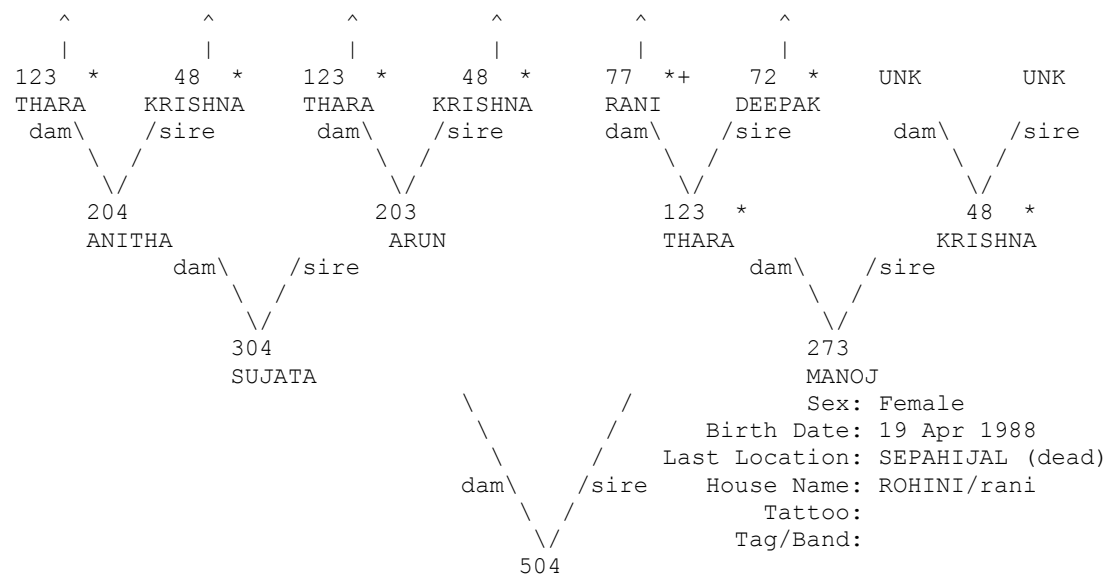

+ Wild-caught... * Appear more than once...
 ^ Pedigree continues beyond top of page...

=====
 Taxon Name: PANTHERA TIGRIS Studbook Number: 505
 =====

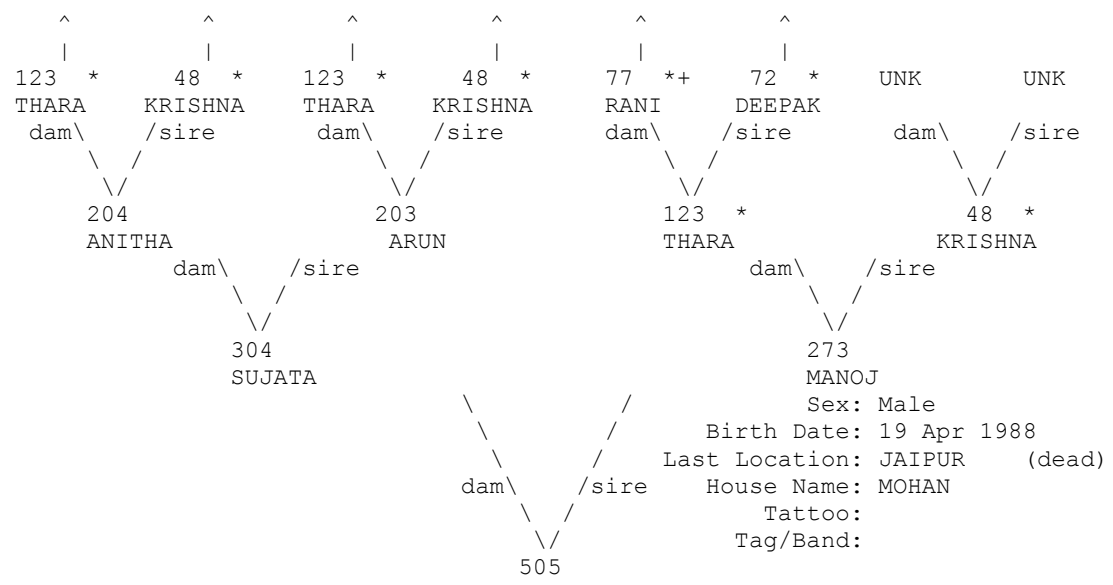

+ Wild-caught... * Appear more than once...
 ^ Pedigree continues beyond top of page...

=====
 Taxon Name: PANTHERA TIGRIS Studbook Number: 506
 =====

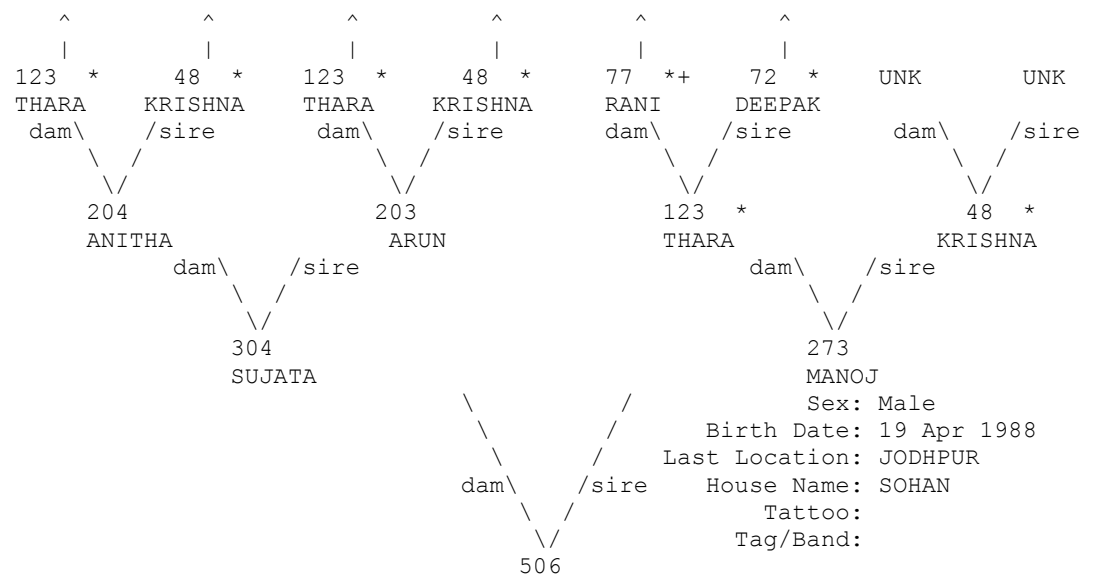

+ Wild-caught... * Appear more than once...
 ^ Pedigree continues beyond top of page...

=====
Taxon Name: PANTHERA TIGRIS Studbook Number: 507
=====

WILD

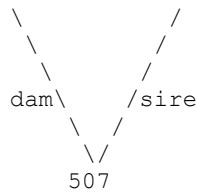

WILD

Sex: Male
Birth Date: ????
Last Location: VISAKAPAT (dead)
House Name:
Tattoo:
Tag/Band:

=====
Taxon Name: PANTHERA TIGRIS Studbook Number: 508
=====

WILD

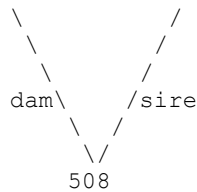

WILD

Sex: Male
Birth Date: ????
Last Location: VISAKAPAT (dead)
House Name:
Tattoo:
Tag/Band:

=====
Taxon Name: PANTHERA TIGRIS Studbook Number: 509
=====

WILD

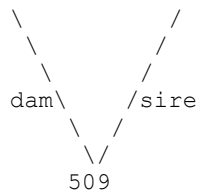

WILD

Sex: Female
Birth Date: ????
Last Location: VISAKAPAT (dead)
House Name:
Tattoo:
Tag/Band:

=====
Taxon Name: PANTHERA TIGRIS Studbook Number: 510
=====

WILD

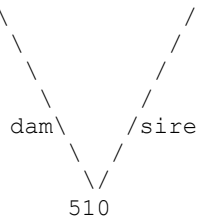

WILD

Sex: Male
Birth Date: ~ 1984
Last Location: HYDERABAD (dead)
House Name: RUDRAMUDU
Tattoo:
Tag/Band:

=====
 Taxon Name: PANTHERA TIGRIS Studbook Number: 511
 =====

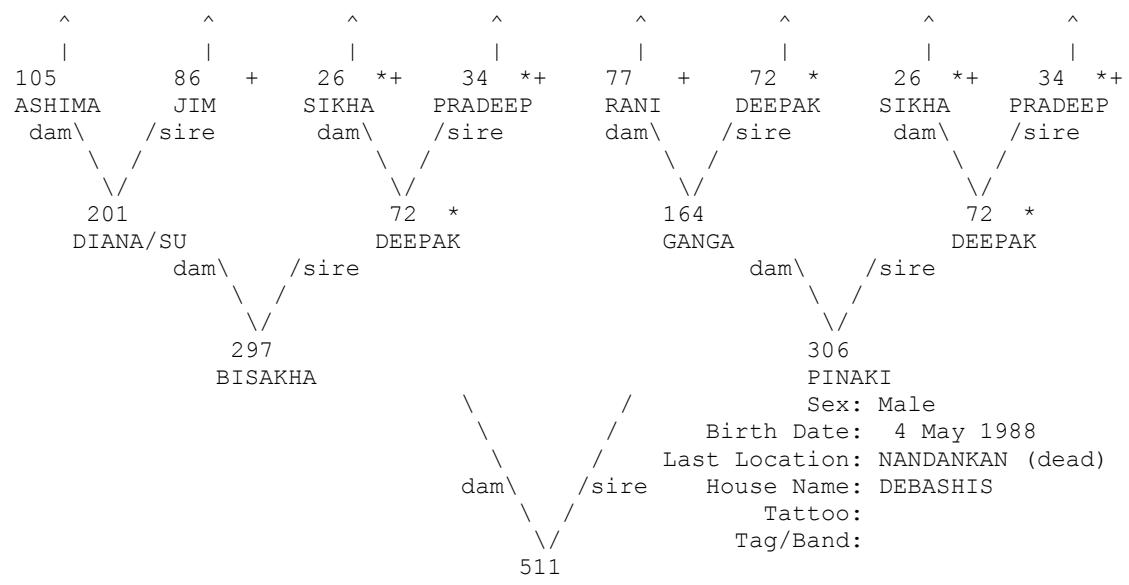

+ Wild-caught... * Appear more than once...
 ^ Pedigree continues beyond top of page...

=====
 Taxon Name: PANTHERA TIGRIS Studbook Number: 512
 =====

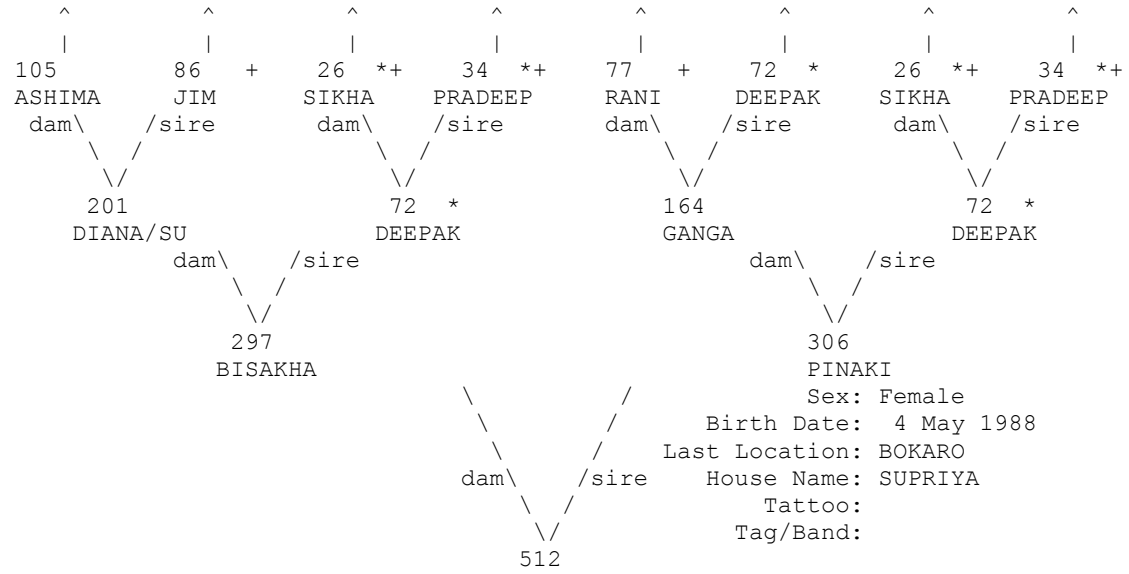

+ Wild-caught... * Appear more than once...
 ^ Pedigree continues beyond top of page...

=====
 Taxon Name: PANTHERA TIGRIS Studbook Number: 513
 =====

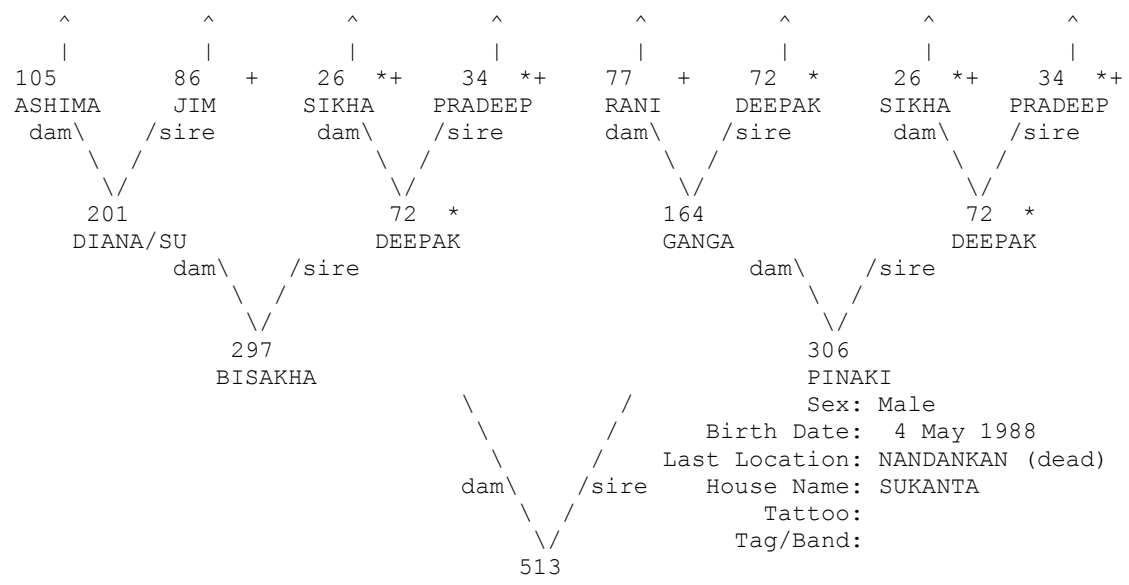

+ Wild-caught... * Appear more than once...
 ^ Pedigree continues beyond top of page...

=====
 Taxon Name: PANTHERA TIGRIS Studbook Number: 514
 =====

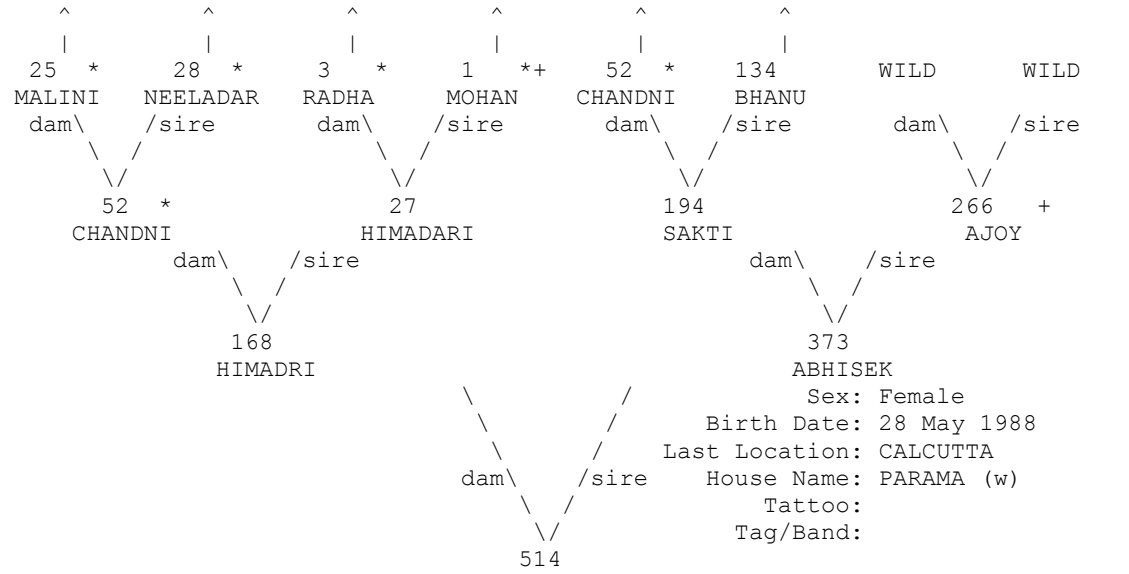

+ Wild-caught... * Appear more than once...
 ^ Pedigree continues beyond top of page...

=====
 Taxon Name: PANTHERA TIGRIS Studbook Number: 515
 =====

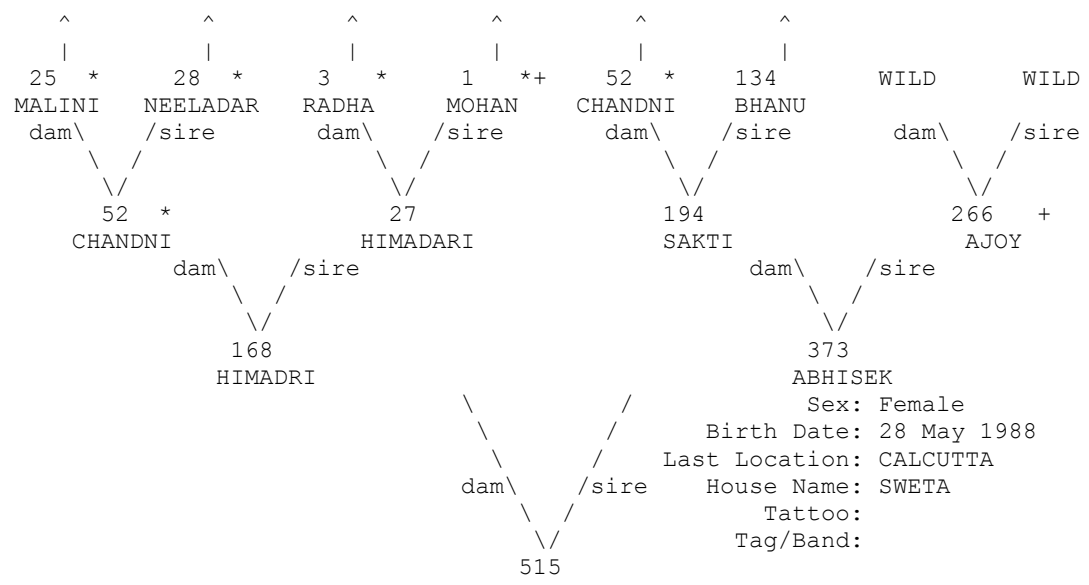

+ Wild-caught... * Appear more than once...
 ^ Pedigree continues beyond top of page...

=====
 Taxon Name: PANTHERA TIGRIS Studbook Number: 516
 =====

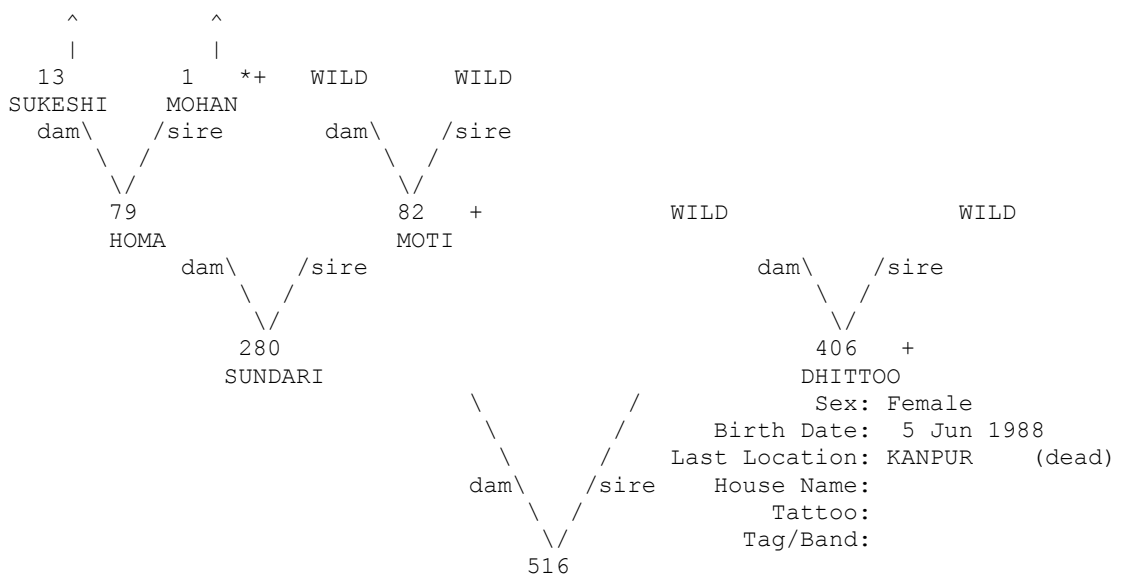

+ Wild-caught... * Appear more than once...
 ^ Pedigree continues beyond top of page...

=====
 Taxon Name: PANTHERA TIGRIS Studbook Number: 517
 =====

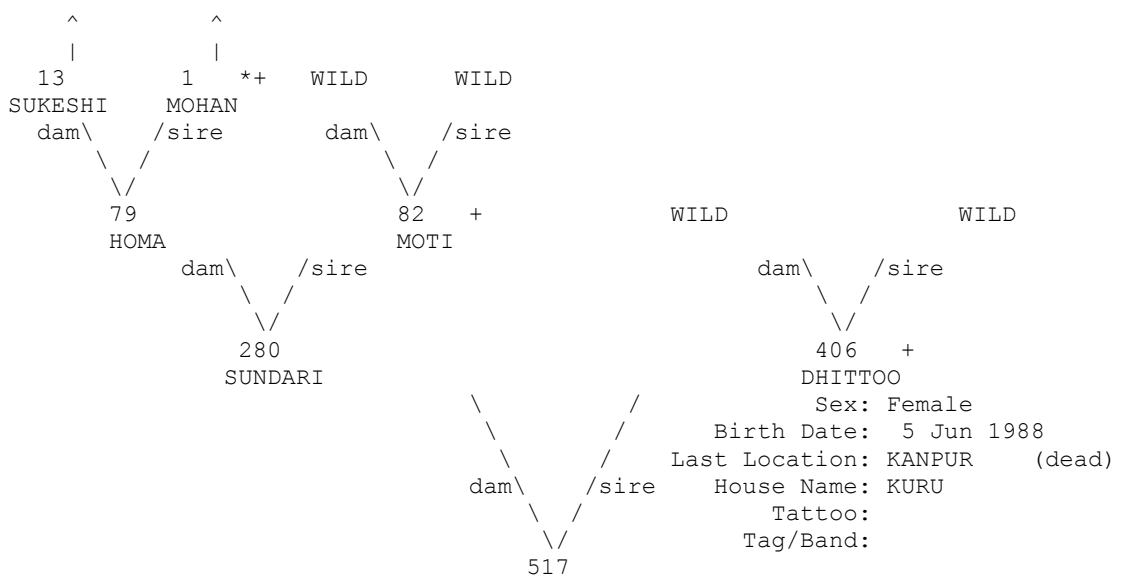

+ Wild-caught... * Appear more than once...
 ^ Pedigree continues beyond top of page...

=====
 Taxon Name: PANTHERA TIGRIS Studbook Number: 518
 =====

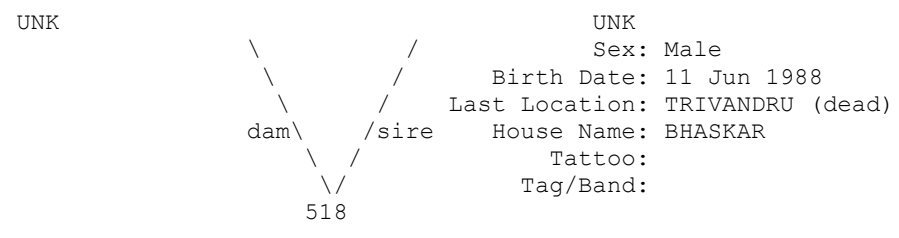

=====
 Taxon Name: PANTHERA TIGRIS Studbook Number: 519
 =====

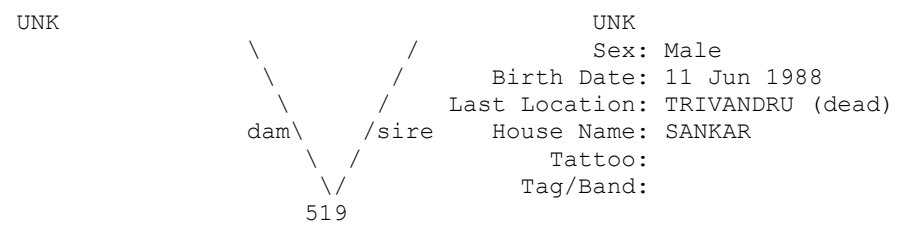

=====
 Taxon Name: PANTHERA TIGRIS Studbook Number: 520
 =====

UNK

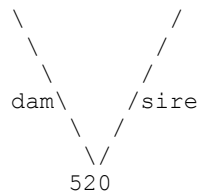

UNK
 Sex: Female
 Birth Date: 11 Jun 1988
 Last Location: TRIVANDRU (dead)
 House Name: ASWATHI (W)
 Tattoo:
 Tag/Band:

=====
 Taxon Name: PANTHERA TIGRIS Studbook Number: 521
 =====

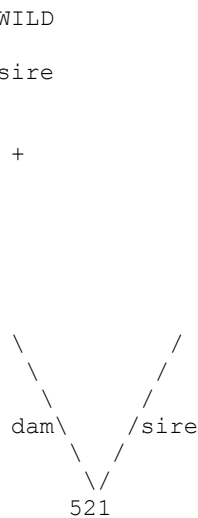
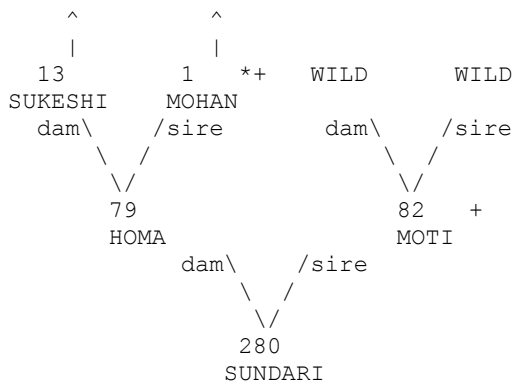

WILD WILD
 dam\ /sire
 \ /
 406 +
 DHITTOO
 Sex: Male
 Birth Date: 13 Jun 1988
 Last Location: KANPUR (dead)
 House Name: RAJ
 Tattoo:
 Tag/Band:

+ Wild-caught... * Appear more than once...
 ^ Pedigree continues beyond top of page...

=====
 Taxon Name: PANTHERA TIGRIS Studbook Number: 522
 =====

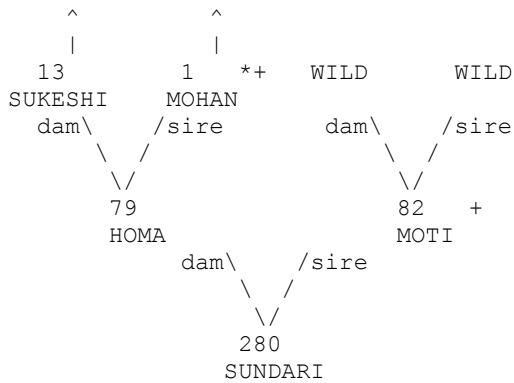

WILD WILD
 dam\ /sire
 \ /
 406 +
 DHITTOO
 Sex: Male
 Birth Date: 13 Jun 1988
 Last Location: GWALIOR
 House Name: KISHORE
 Tattoo:
 Tag/Band:

+ Wild-caught... * Appear more than once...
 ^ Pedigree continues beyond top of page...

=====
Taxon Name: PANTHERA TIGRIS Studbook Number: 523
=====

UNK UNK
Sex: Male
Birth Date: 1 Jul 1988
Last Location: TRIVANDRU (dead)
House Name: MANU
Tattoo:
Tag/Band:
dam \ / sire
523

=====
Taxon Name: PANTHERA TIGRIS Studbook Number: 524
=====

UNK UNK
Sex: Male
Birth Date: 1 Jul 1988
Last Location: TRIVANDRU (dead)
House Name: MOHAN
Tattoo:
Tag/Band:
dam \ / sire
524

=====
Taxon Name: PANTHERA TIGRIS Studbook Number: 525
=====

UNK UNK
Sex: Male
Birth Date: 1 Jul 1988
Last Location: TRIVANDRU (dead)
House Name: HARI
Tattoo:
Tag/Band:
dam \ / sire
525

=====
Taxon Name: PANTHERA TIGRIS Studbook Number: 526
=====

WILD WILD
Sex: Female
Birth Date: ~ 1983
Last Location: ITANAGAR (dead)
House Name: RANI
Tattoo:
Tag/Band:
dam \ / sire
526

=====
 Taxon Name: PANTHERA TIGRIS Studbook Number: 527
 =====

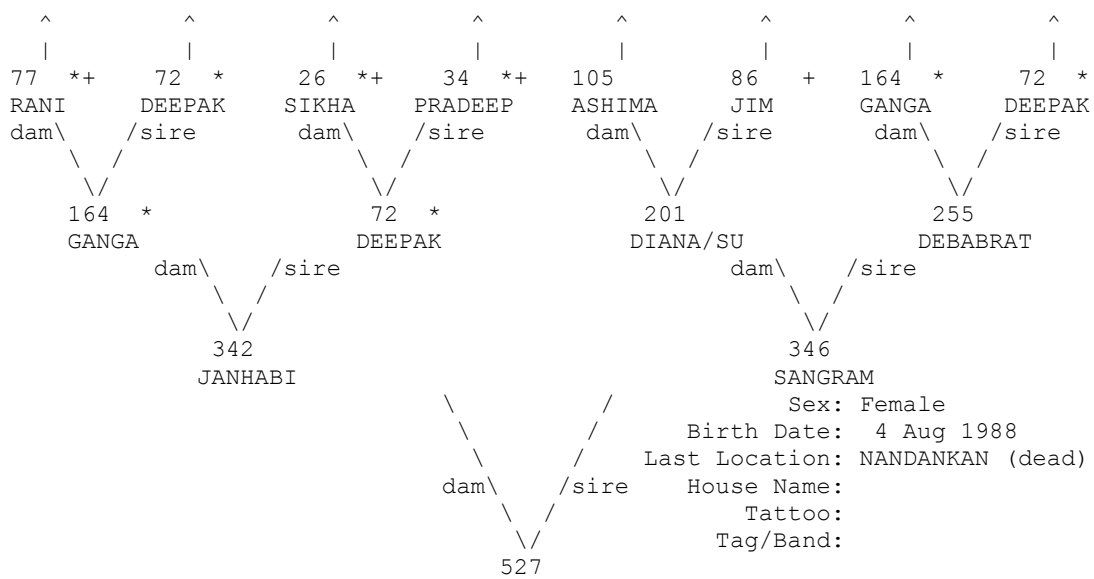

+ Wild-caught... * Appear more than once...
 ^ Pedigree continues beyond top of page...

=====
 Taxon Name: PANTHERA TIGRIS Studbook Number: 528
 =====

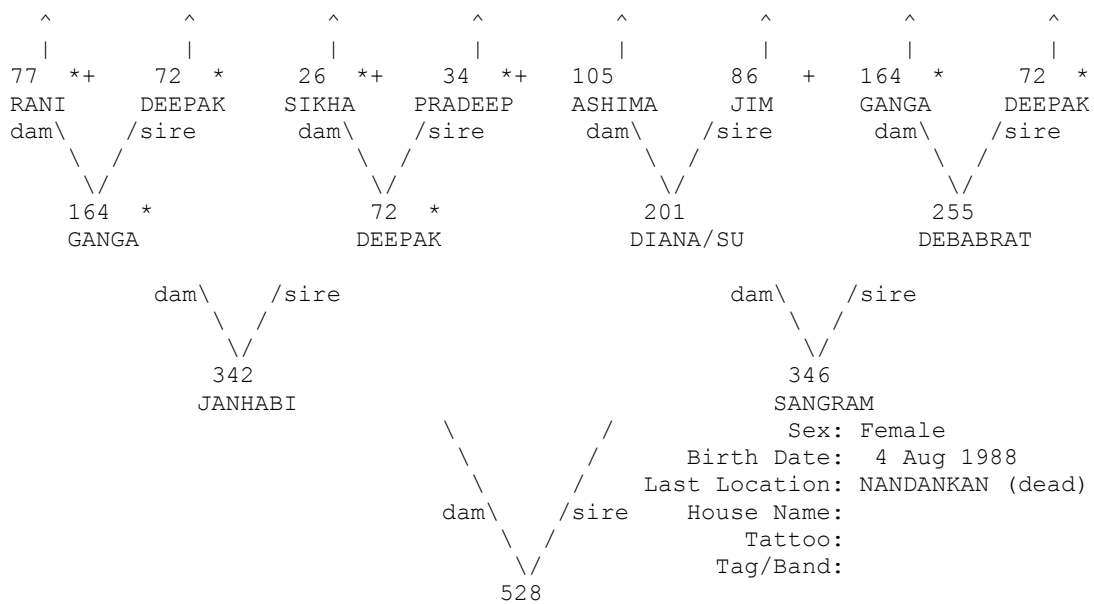

+ Wild-caught... * Appear more than once...
 ^ Pedigree continues beyond top of page...

=====
 Taxon Name: PANTHERA TIGRIS Studbook Number: 529
 =====

WILD

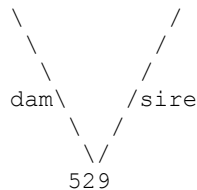

WILD
 Sex: Female
 Birth Date: ~ Feb 1988
 Last Location: VANVIHAR (dead)
 House Name: MOHINI
 Tattoo:
 Tag/Band:

=====
 Taxon Name: PANTHERA TIGRIS Studbook Number: 530
 =====

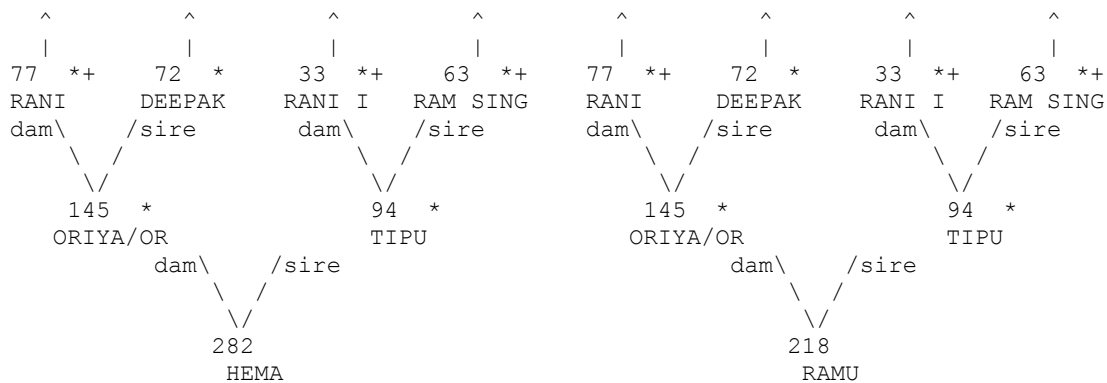

Sex: Male
 Birth Date: 21 Aug 1988
 Last Location: RAJKOT (dead)
 House Name: ROHIT/UDAY
 Tattoo:
 Tag/Band:

+ Wild-caught... * Appear more than once...
 ^ Pedigree continues beyond top of page...

=====
 Taxon Name: PANTHERA TIGRIS Studbook Number: 533
 =====

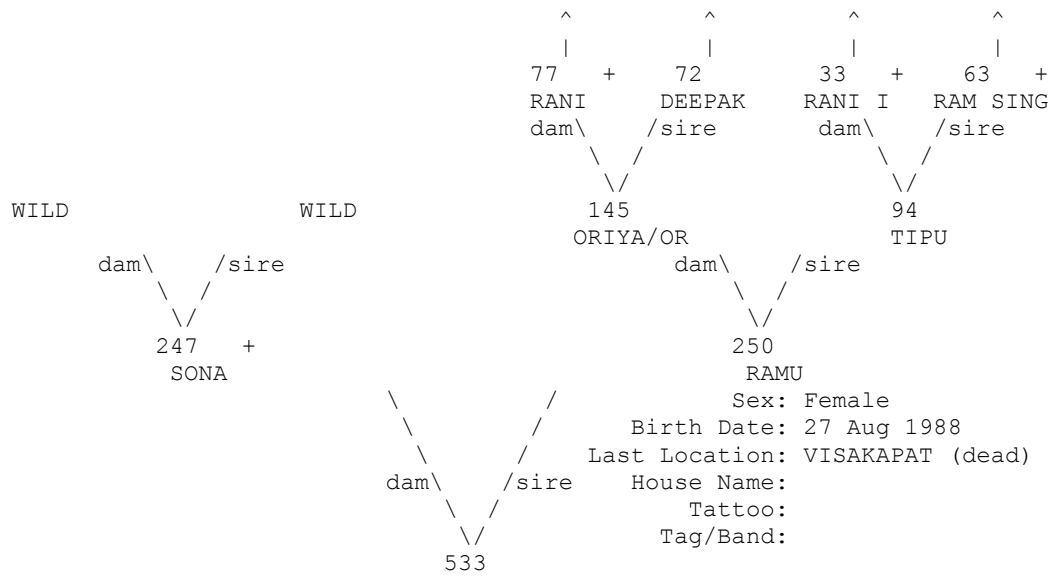

+ Wild-caught...
 ^ Pedigree continues beyond top of page...

=====
 Taxon Name: PANTHERA TIGRIS Studbook Number: 534
 =====

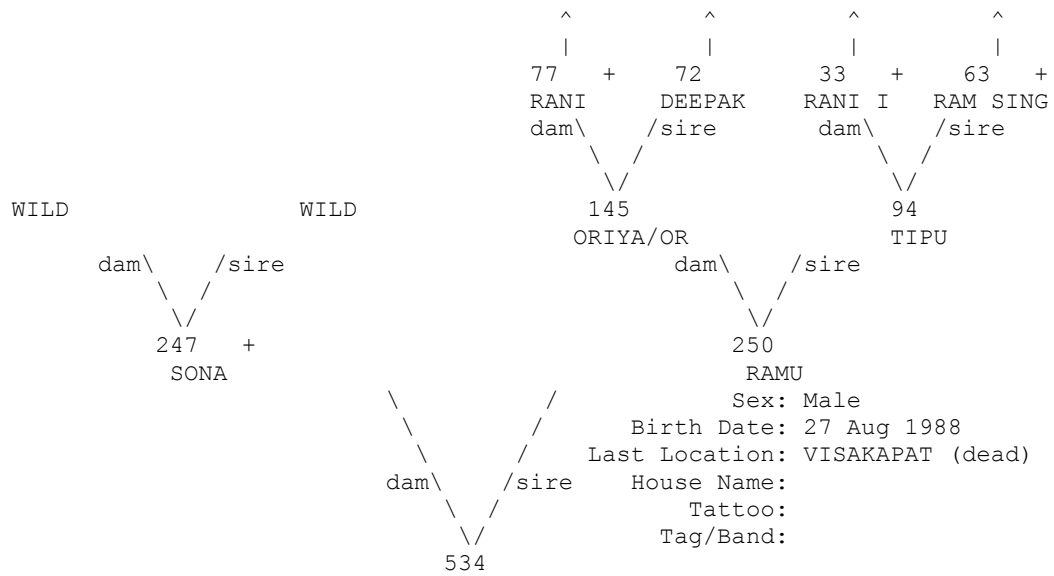

+ Wild-caught...
 ^ Pedigree continues beyond top of page...

=====
 Taxon Name: PANTHERA TIGRIS Studbook Number: 535
 =====

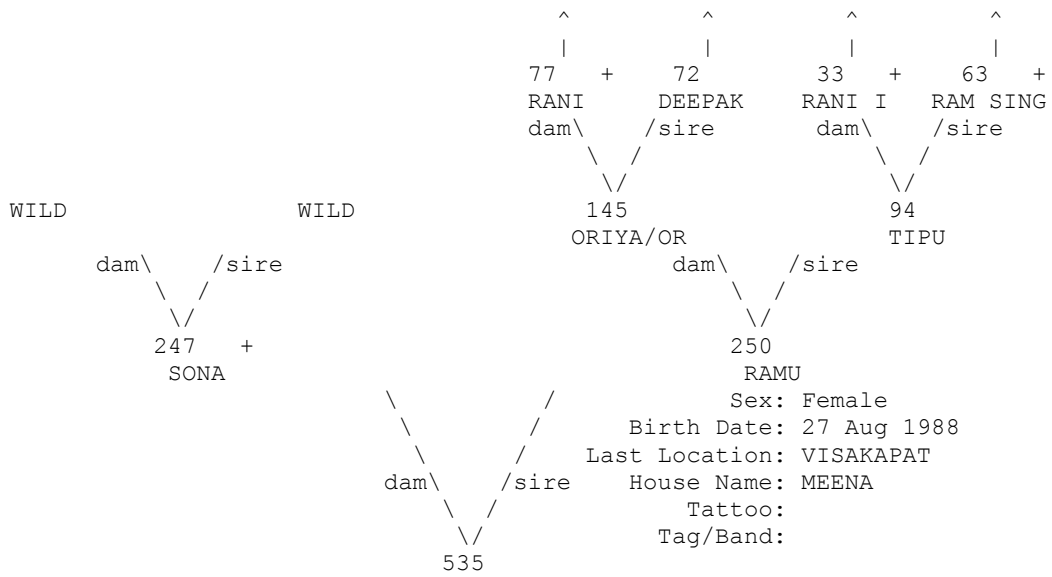

+ Wild-caught...
 ^ Pedigree continues beyond top of page...

=====
 Taxon Name: PANTHERA TIGRIS Studbook Number: 536
 =====

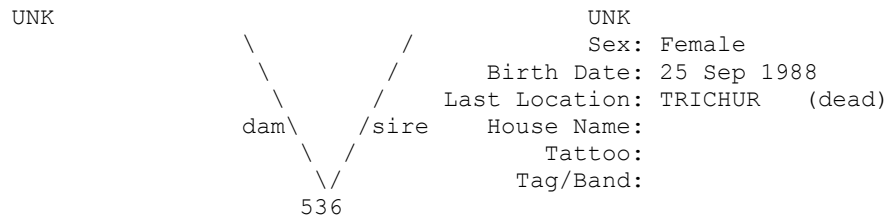

=====
 Taxon Name: PANTHERA TIGRIS Studbook Number: 537
 =====

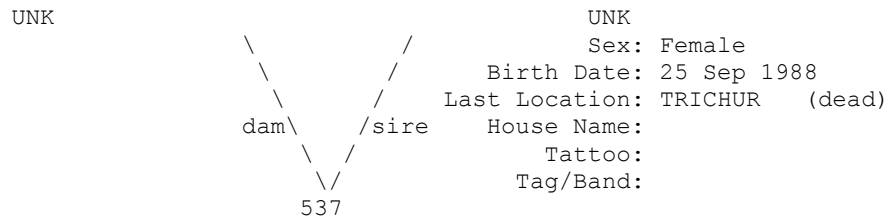

=====
 Taxon Name: PANTHERA TIGRIS Studbook Number: 538
 =====

UNK

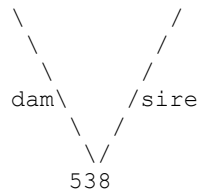

Sex: Male
 Birth Date: 25 Sep 1988
 Last Location: TRIVANDRU (dead)
 House Name: RAJA
 Tattoo:
 Tag/Band:

=====
 Taxon Name: PANTHERA TIGRIS Studbook Number: 539
 =====

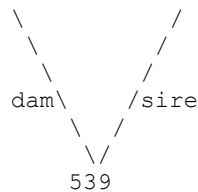
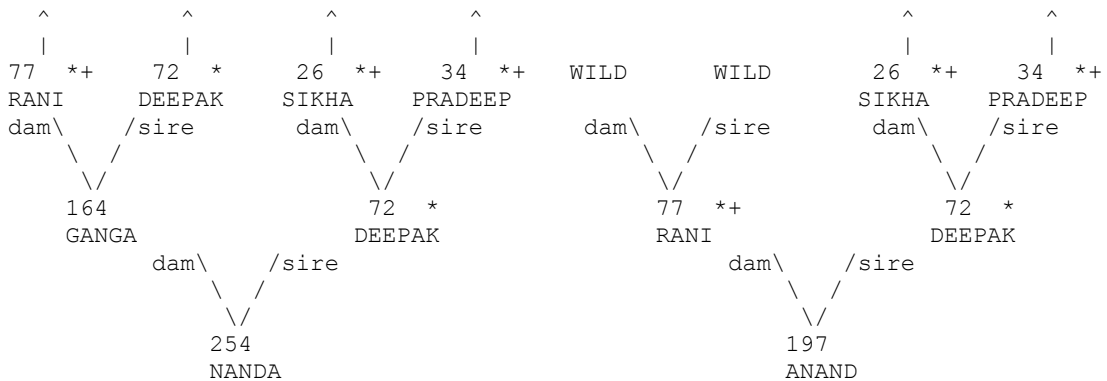

Sex: Male
 Birth Date: 1 Oct 1988
 Last Location: NANDANKAN (dead)
 House Name:
 Tattoo:
 Tag/Band:

+ Wild-caught... * Appear more than once...
 ^ Pedigree continues beyond top of page...

=====
 Taxon Name: PANTHERA TIGRIS Studbook Number: 540
 =====

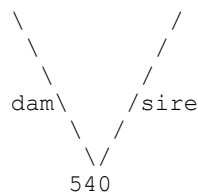
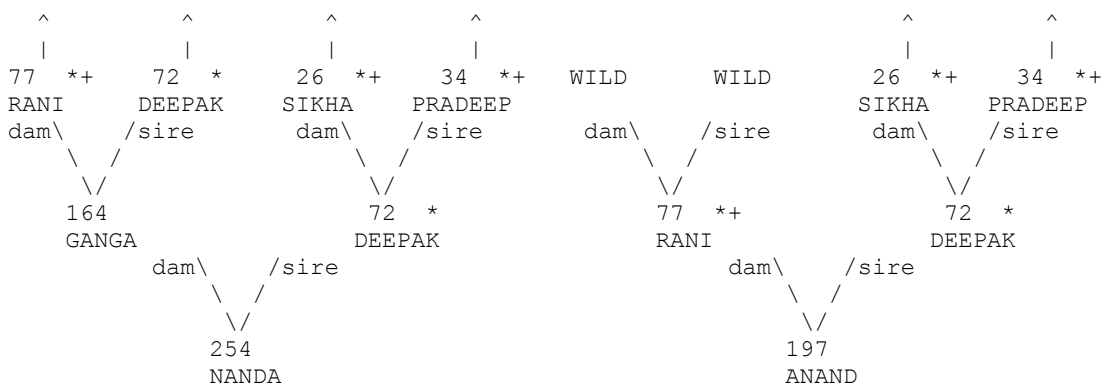

Sex: Male
 Birth Date: 1 Oct 1988
 Last Location: NANDANKAN (dead)
 House Name:
 Tattoo:
 Tag/Band:

+ Wild-caught... * Appear more than once...
 ^ Pedigree continues beyond top of page...

=====
 Taxon Name: PANTHERA TIGRIS Studbook Number: 541
 =====

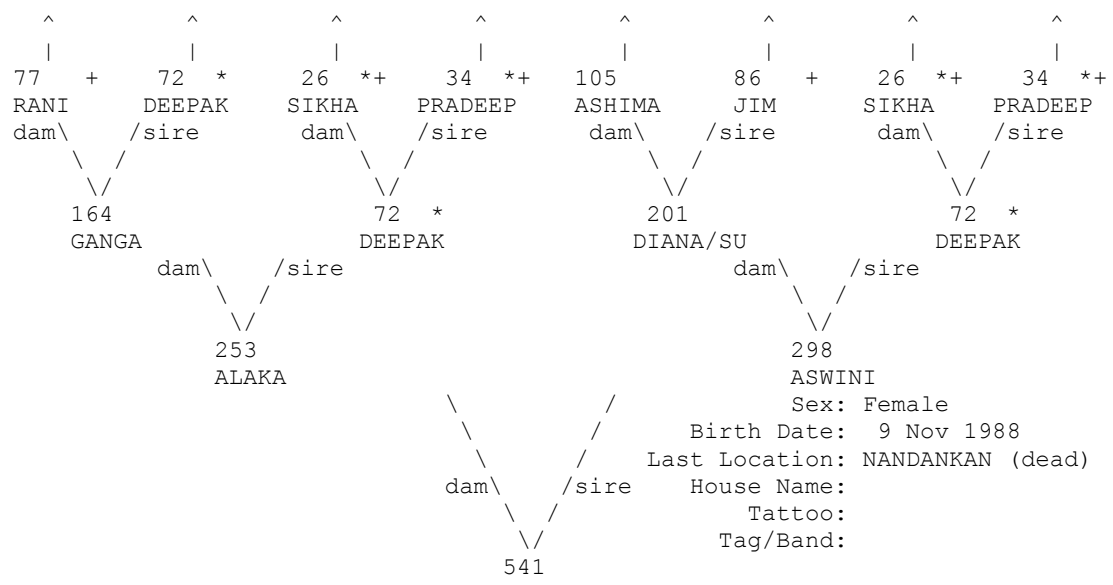

+ Wild-caught... * Appear more than once...
 ^ Pedigree continues beyond top of page...

=====
 Taxon Name: PANTHERA TIGRIS Studbook Number: 542
 =====

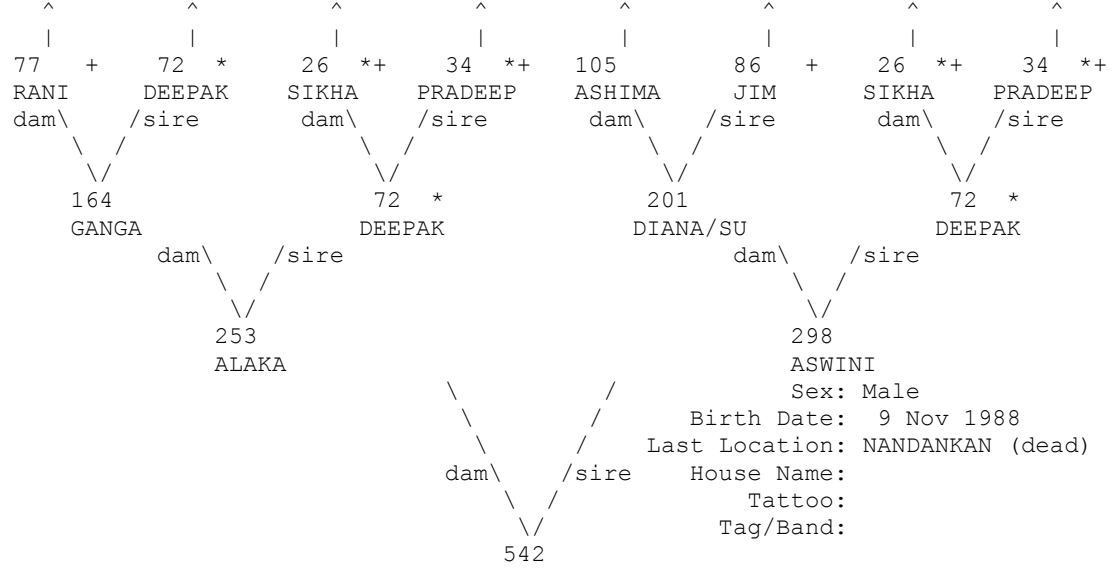

+ Wild-caught... * Appear more than once...
 ^ Pedigree continues beyond top of page...

=====
 Taxon Name: PANTHERA TIGRIS Studbook Number: 543
 =====

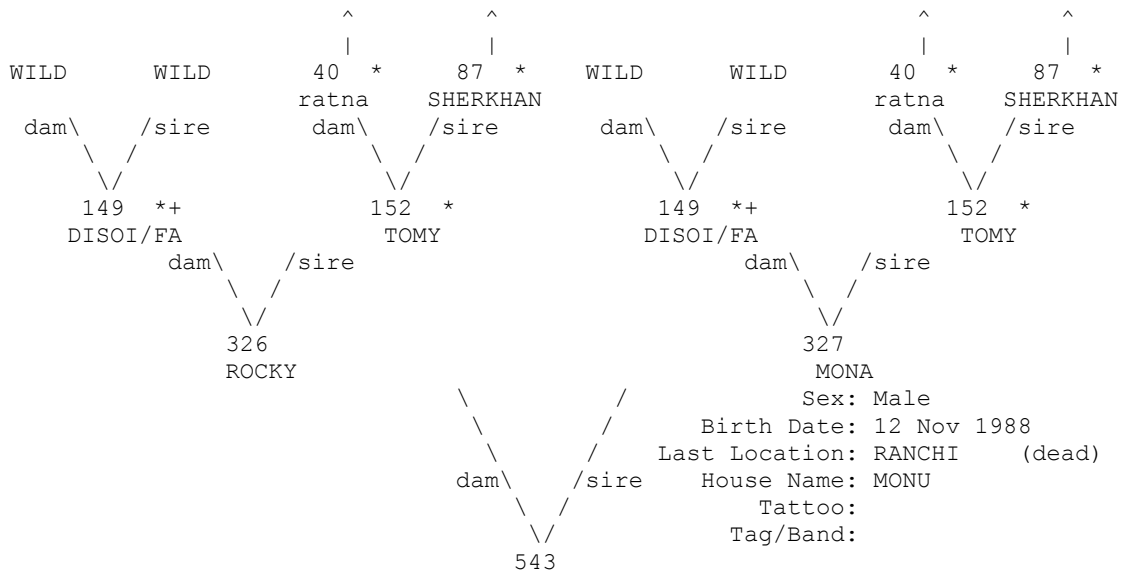

+ Wild-caught... * Appear more than once...
 ^ Pedigree continues beyond top of page...

=====
 Taxon Name: PANTHERA TIGRIS Studbook Number: 544
 =====

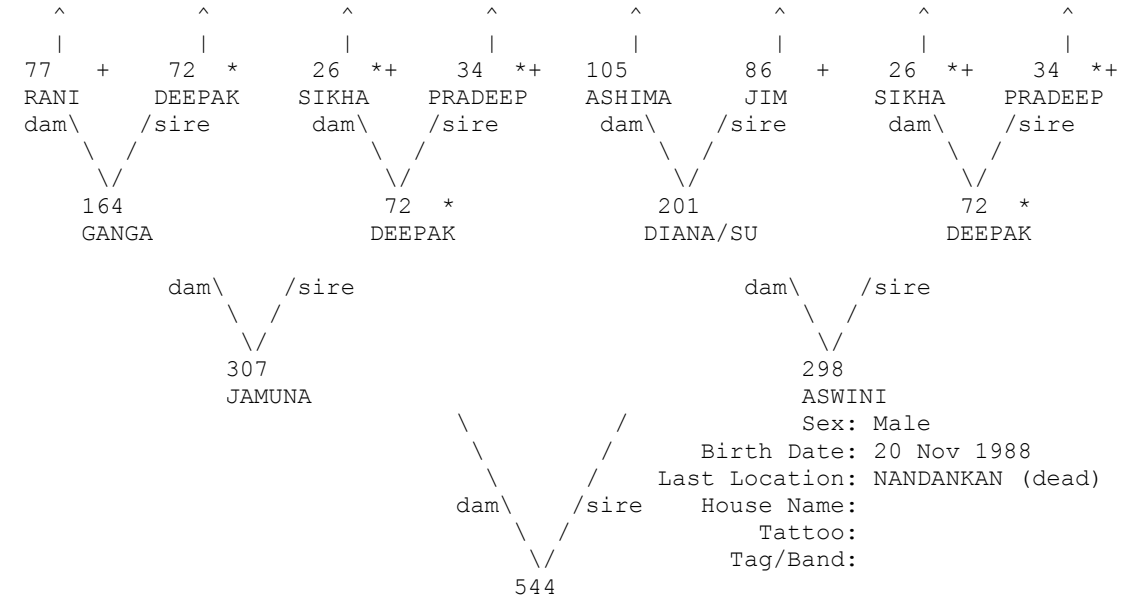

+ Wild-caught... * Appear more than once...
 ^ Pedigree continues beyond top of page...

=====
 Taxon Name: PANTHERA TIGRIS Studbook Number: 545
 =====

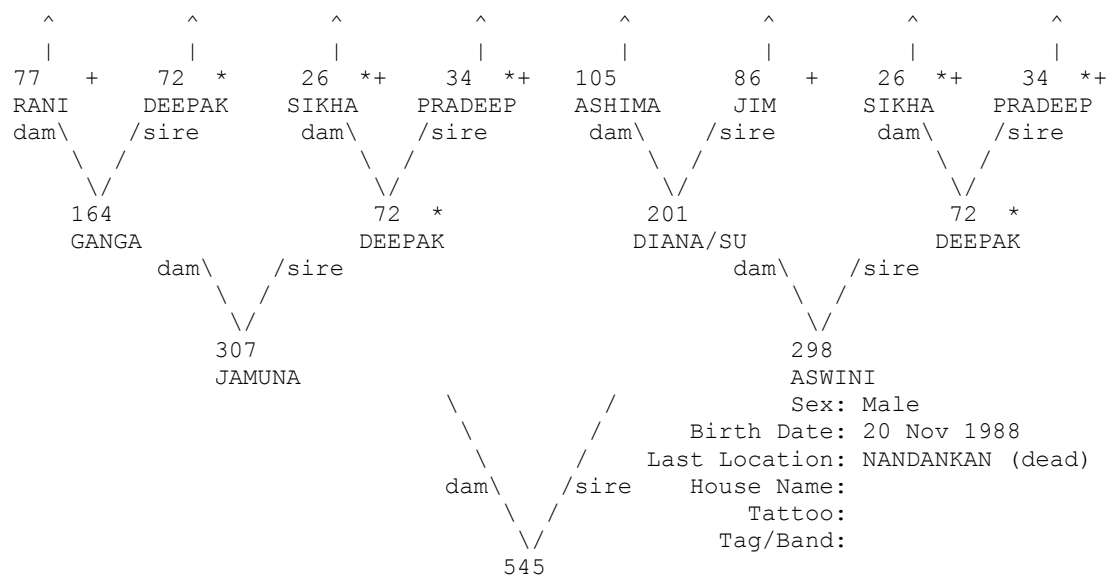

+ Wild-caught... * Appear more than once...
 ^ Pedigree continues beyond top of page...

=====
 Taxon Name: PANTHERA TIGRIS Studbook Number: 546
 =====

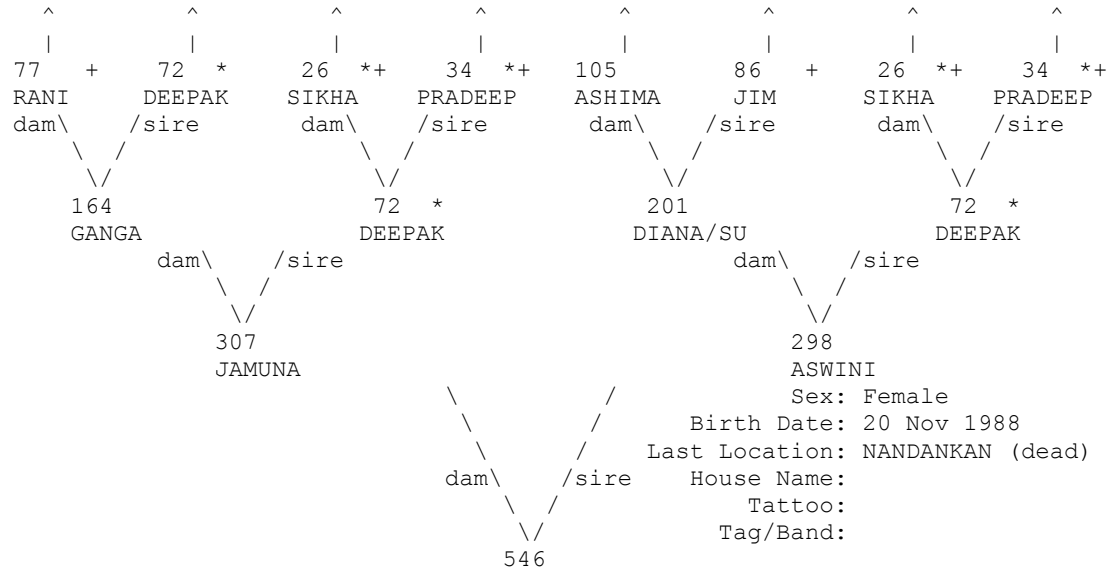

+ Wild-caught... * Appear more than once...
 ^ Pedigree continues beyond top of page...

=====
 Taxon Name: PANTHERA TIGRIS Studbook Number: 547
 =====

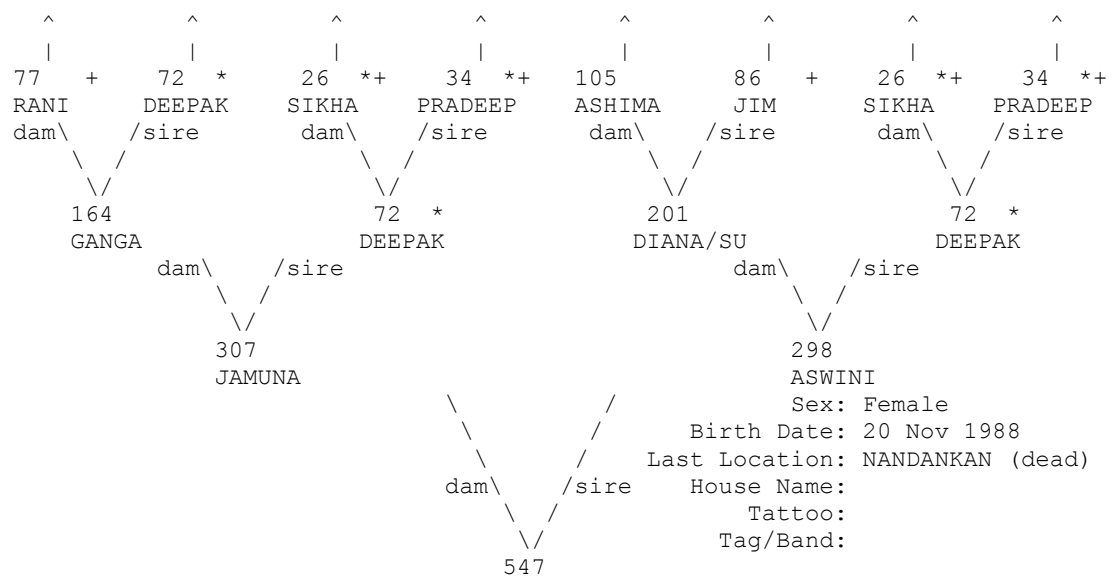

+ Wild-caught... * Appear more than once...
 ^ Pedigree continues beyond top of page...

=====
 Taxon Name: PANTHERA TIGRIS Studbook Number: 548
 =====

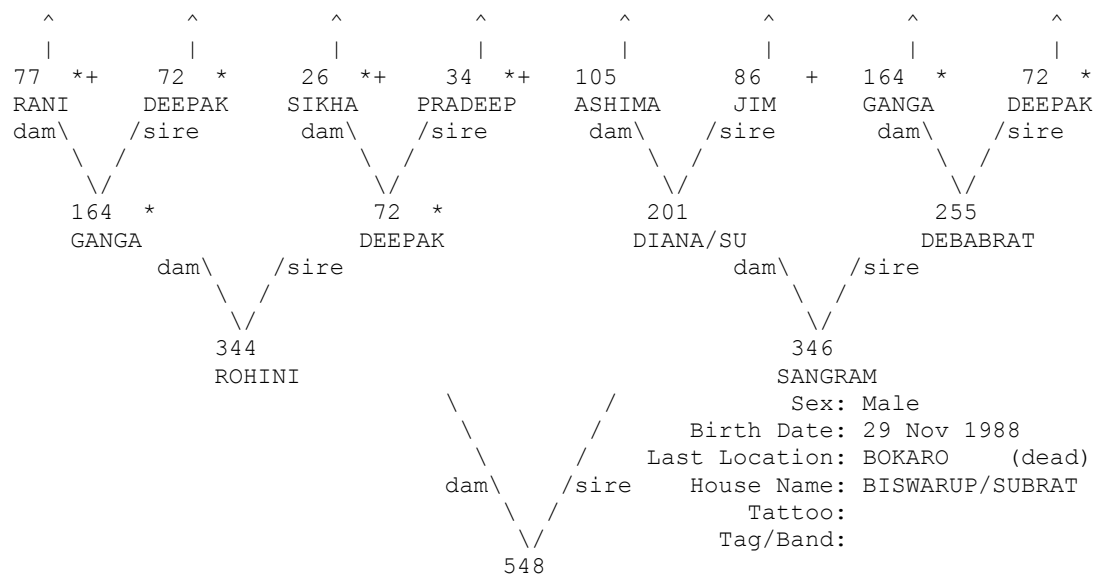

+ Wild-caught... * Appear more than once...
 ^ Pedigree continues beyond top of page...

=====
 Taxon Name: PANTHERA TIGRIS Studbook Number: 549
 =====

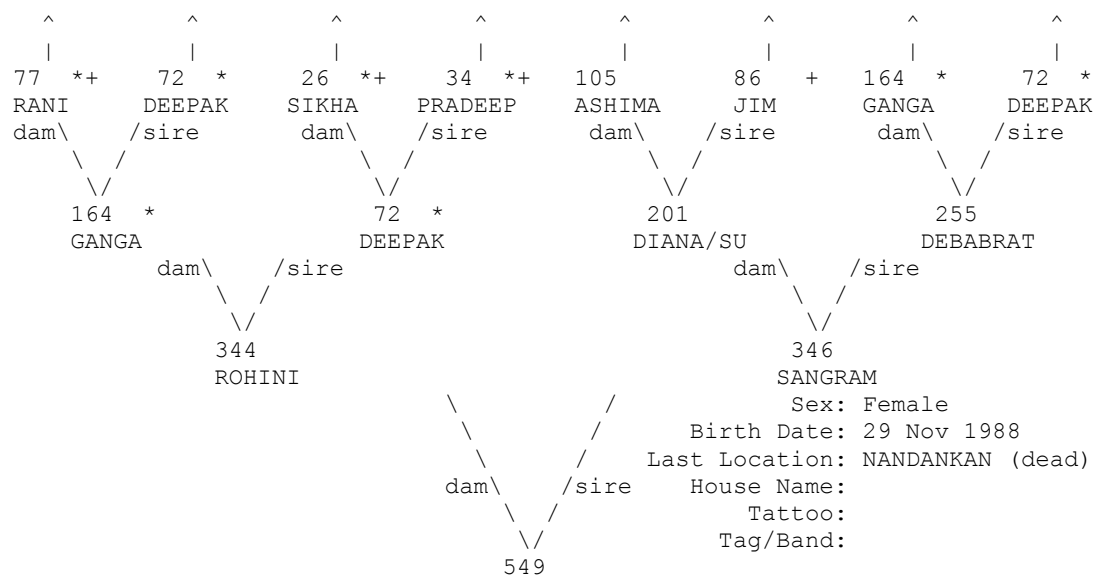

+ Wild-caught... * Appear more than once...
 ^ Pedigree continues beyond top of page...

=====
 Taxon Name: PANTHERA TIGRIS Studbook Number: 550
 =====

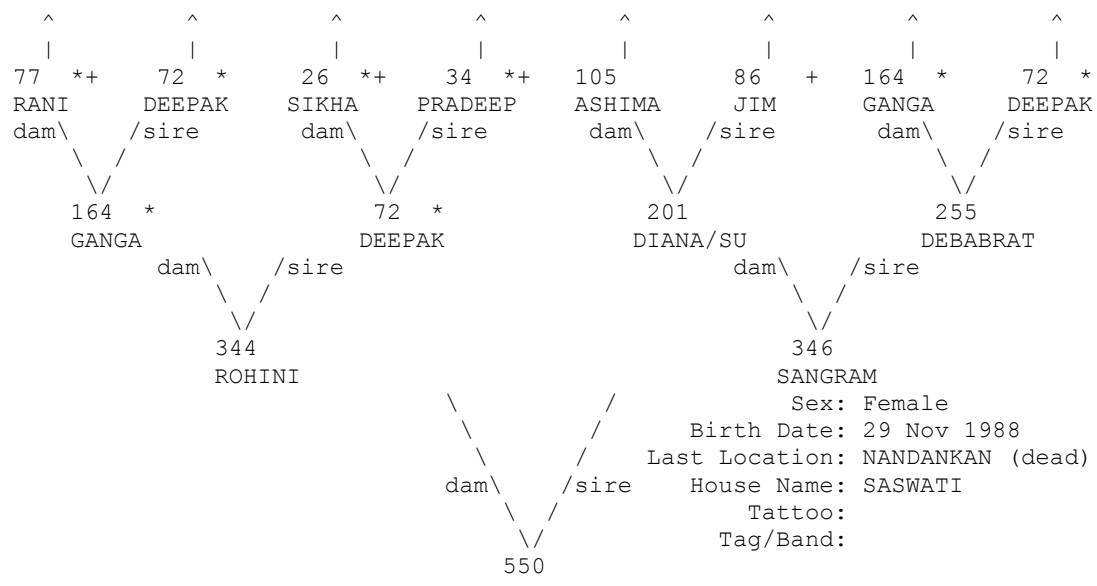

+ Wild-caught... * Appear more than once...
 ^ Pedigree continues beyond top of page...

=====
 Taxon Name: PANTHERA TIGRIS Studbook Number: 551
 =====

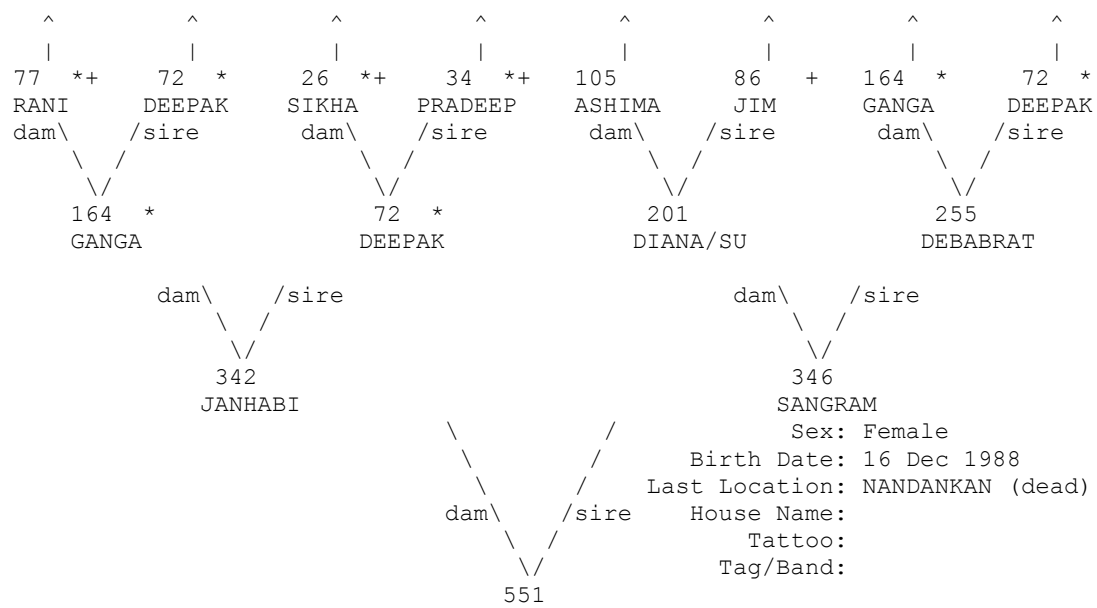

+ Wild-caught... * Appear more than once...
 ^ Pedigree continues beyond top of page...

=====
 Taxon Name: PANTHERA TIGRIS Studbook Number: 552
 =====

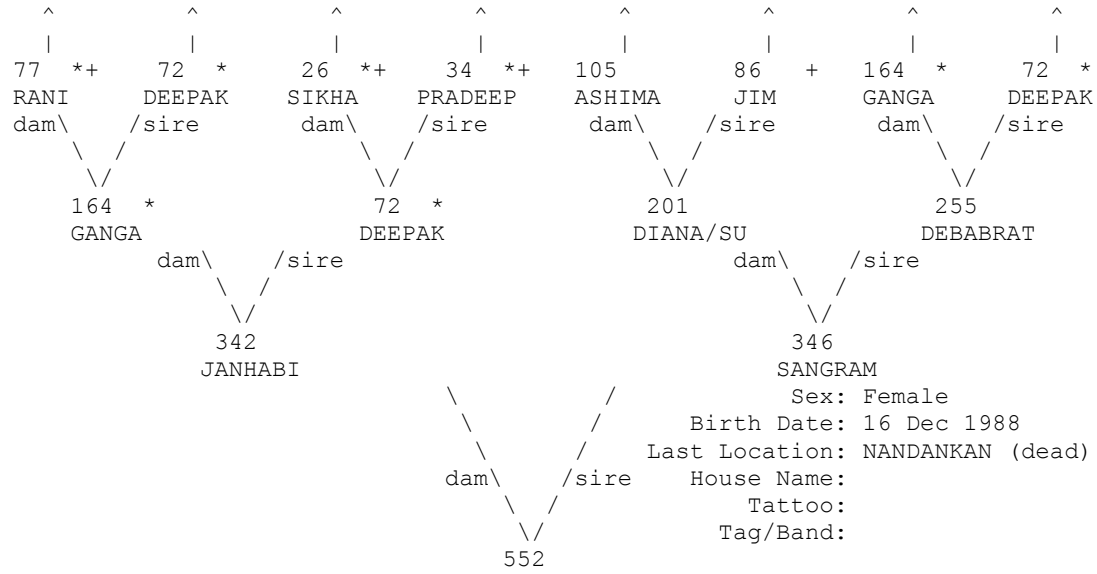

+ Wild-caught... * Appear more than once...
 ^ Pedigree continues beyond top of page...

=====
 Taxon Name: PANTHERA TIGRIS Studbook Number: 553
 =====

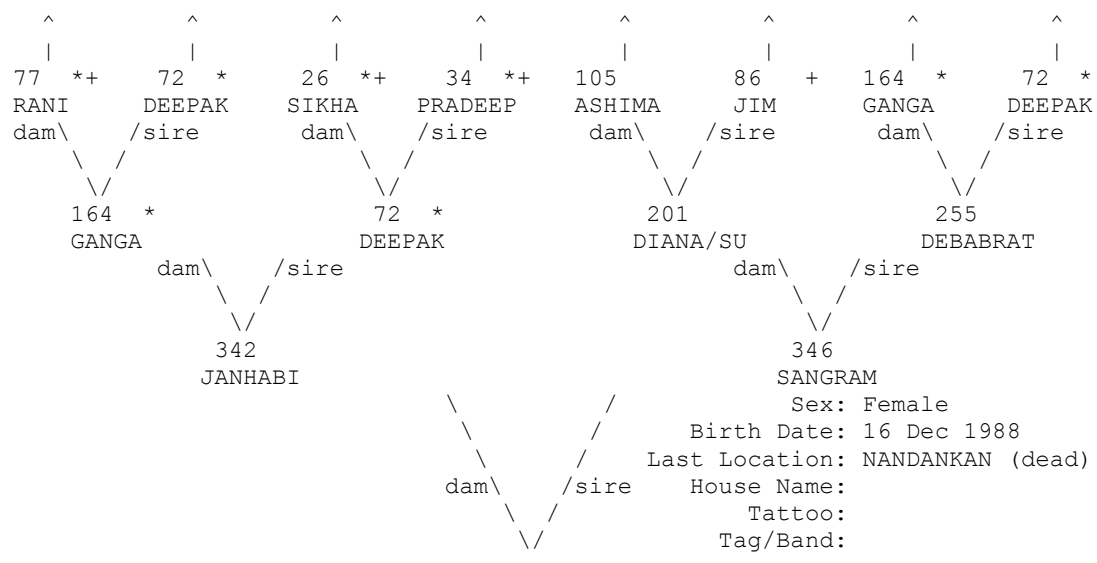

+ Wild-caught... * Appear more than once...
 ^ Pedigree continues beyond top of page...

=====
 Taxon Name: PANTHERA TIGRIS Studbook Number: 554
 =====

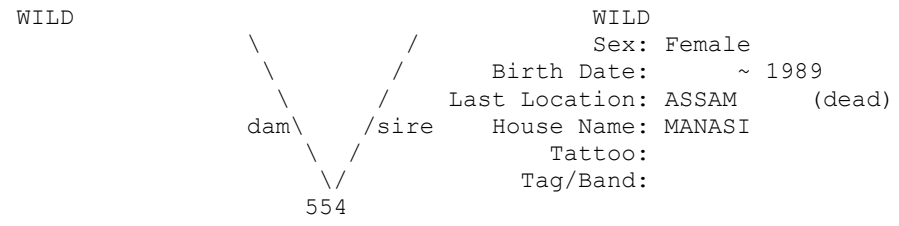

=====
 Taxon Name: PANTHERA TIGRIS Studbook Number: 555
 =====

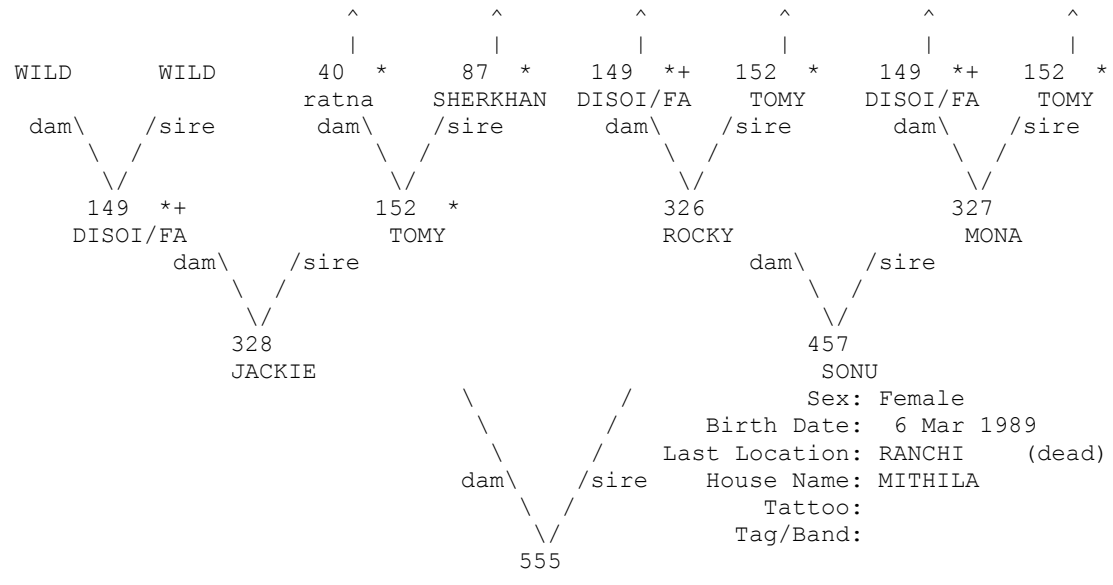

+ Wild-caught... * Appear more than once...
 ^ Pedigree continues beyond top of page...

=====
 Taxon Name: PANTHERA TIGRIS Studbook Number: 556
 =====

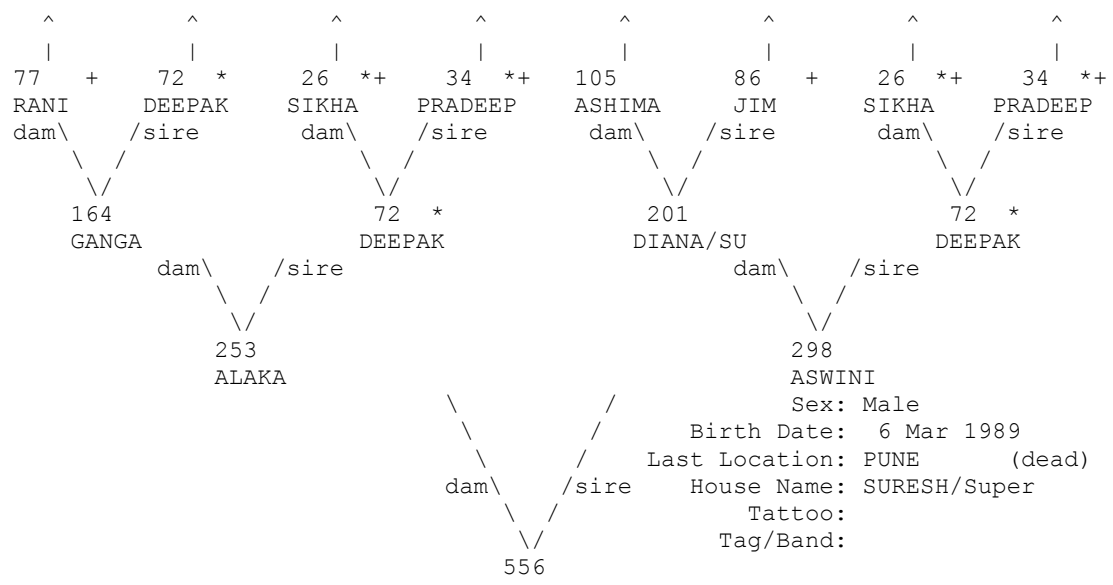

+ Wild-caught... * Appear more than once...
 ^ Pedigree continues beyond top of page...

=====
 Taxon Name: PANTHERA TIGRIS Studbook Number: 557
 =====

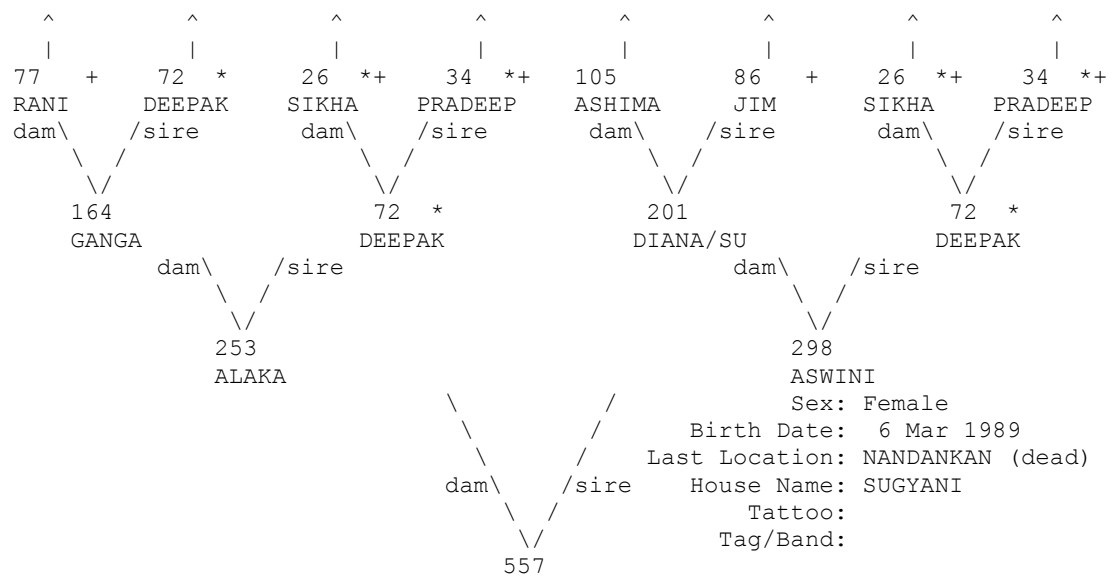

+ Wild-caught... * Appear more than once...
 ^ Pedigree continues beyond top of page...

=====
 Taxon Name: PANTHERA TIGRIS Studbook Number: 558
 =====

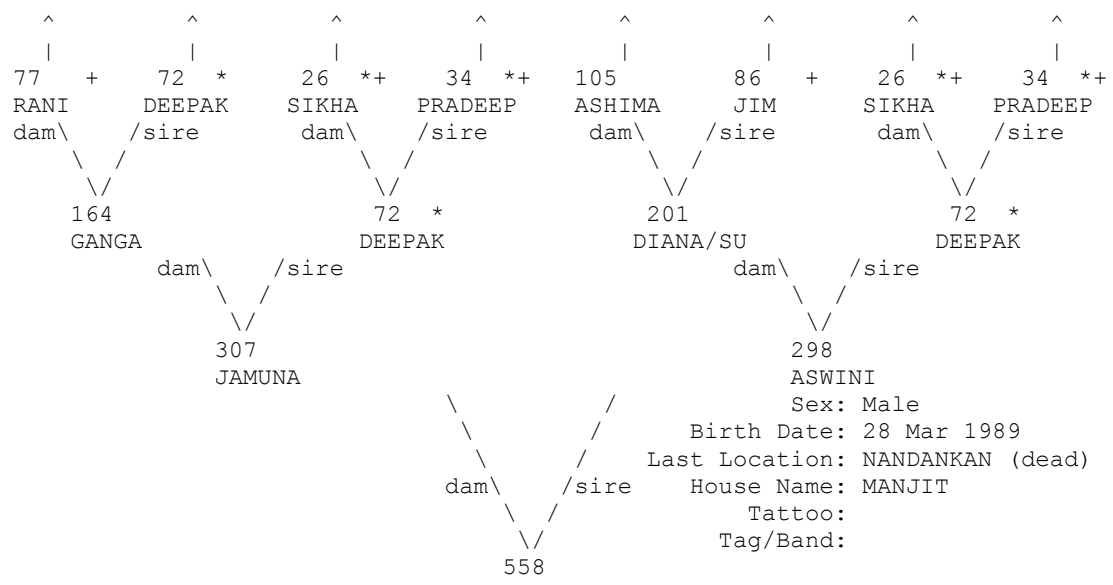

+ Wild-caught... * Appear more than once...
 ^ Pedigree continues beyond top of page...

=====
 Taxon Name: PANTHERA TIGRIS Studbook Number: 559
 =====

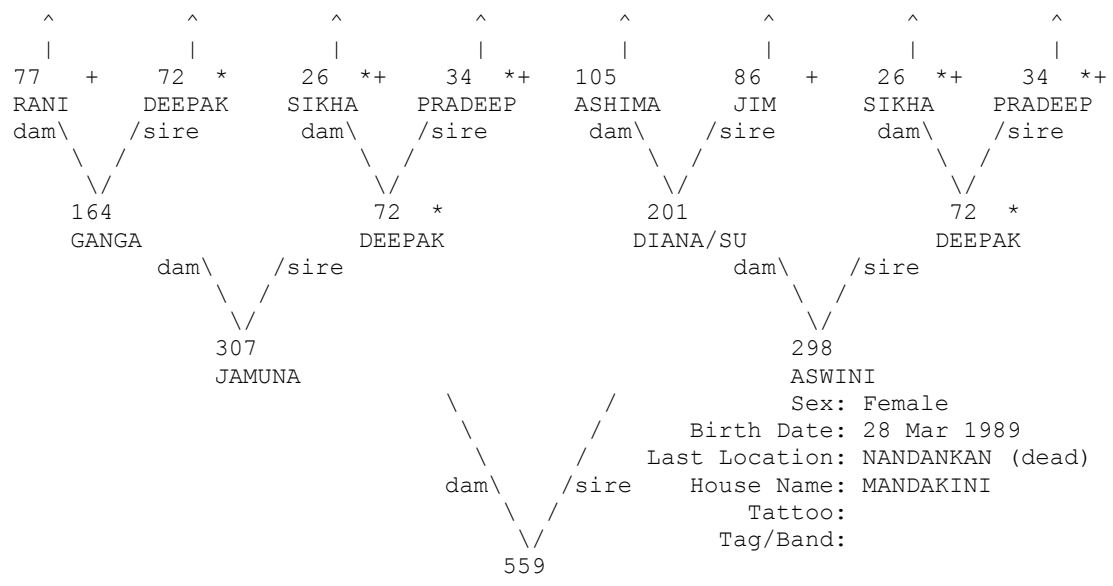

+ Wild-caught... * Appear more than once...
 ^ Pedigree continues beyond top of page...

=====
 Taxon Name: PANTHERA TIGRIS Studbook Number: 560
 =====

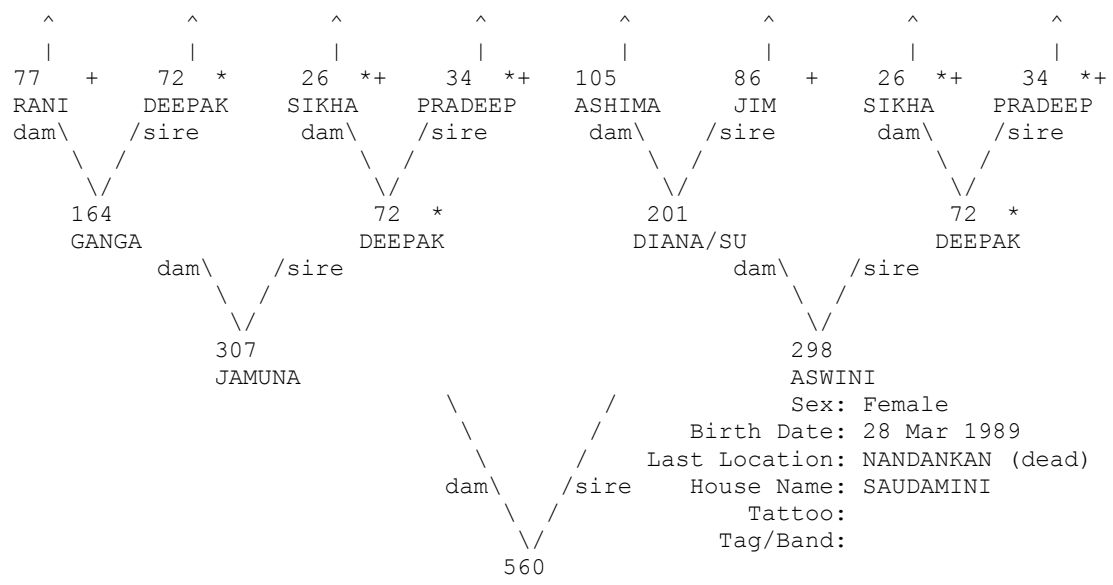

+ Wild-caught... * Appear more than once...
 ^ Pedigree continues beyond top of page...

=====
 Taxon Name: PANTHERA TIGRIS Studbook Number: 561
 =====

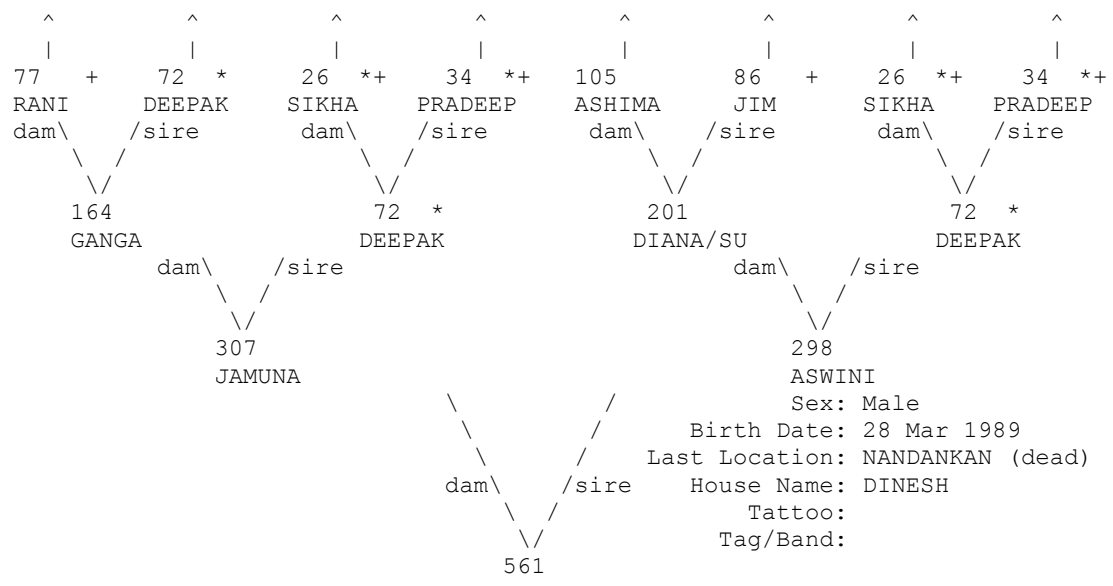

+ Wild-caught... * Appear more than once...
 ^ Pedigree continues beyond top of page...

=====

Taxon Name: PANTHERA TIGRIS Studbook Number: 562

=====

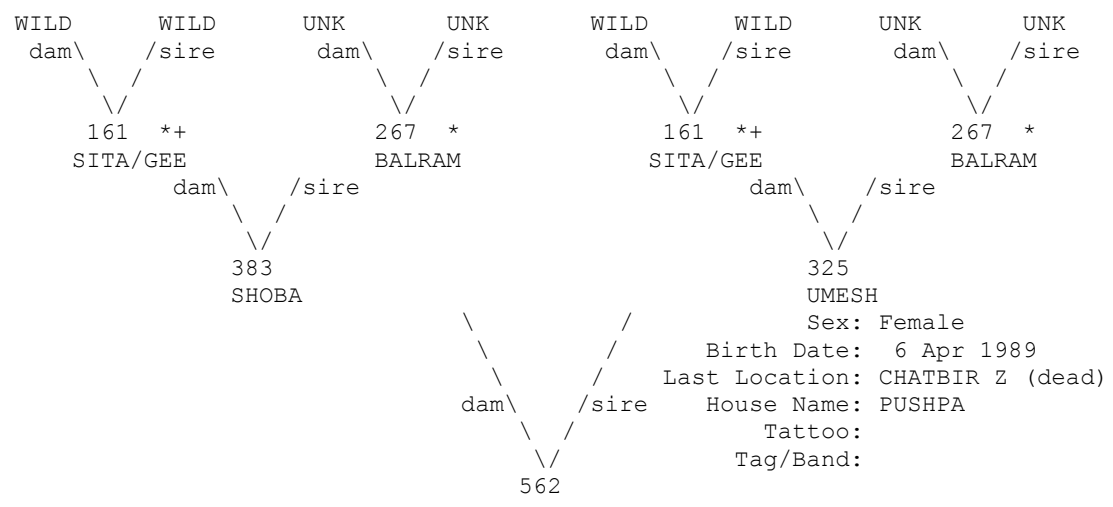

+ Wild-caught... * Appear more than once...

=====

Taxon Name: PANTHERA TIGRIS Studbook Number: 563

=====

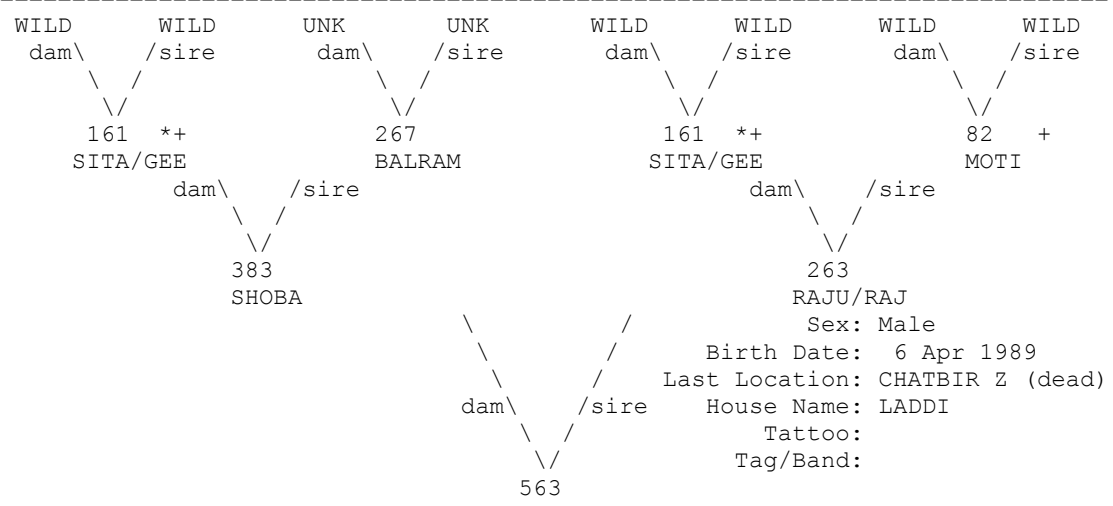

+ Wild-caught... * Appear more than once...

=====
 Taxon Name: PANTHERA TIGRIS Studbook Number: 564
 =====

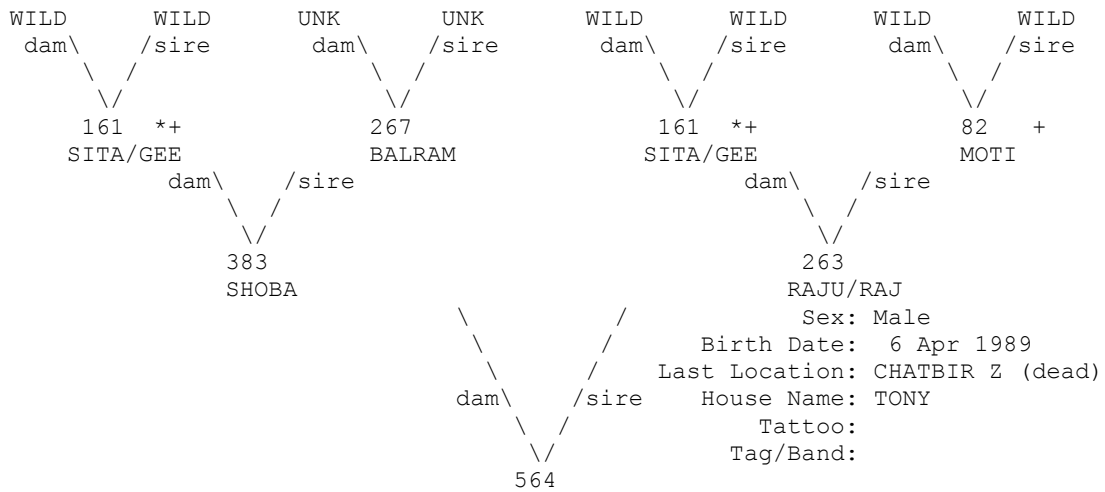

+ Wild-caught... * Appear more than once...

=====
 Taxon Name: PANTHERA TIGRIS Studbook Number: 565
 =====

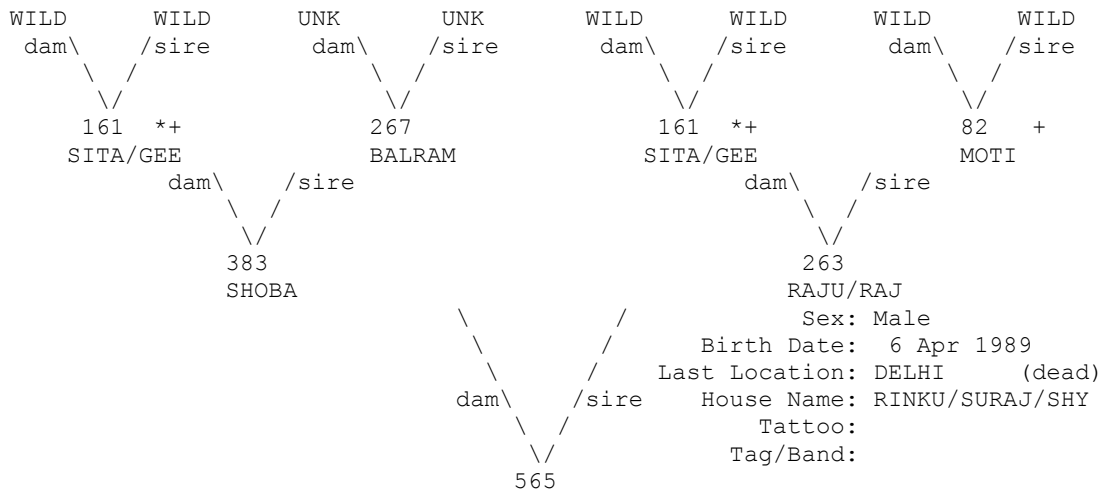

+ Wild-caught... * Appear more than once...

=====
 Taxon Name: PANTHERA TIGRIS Studbook Number: 566
 =====

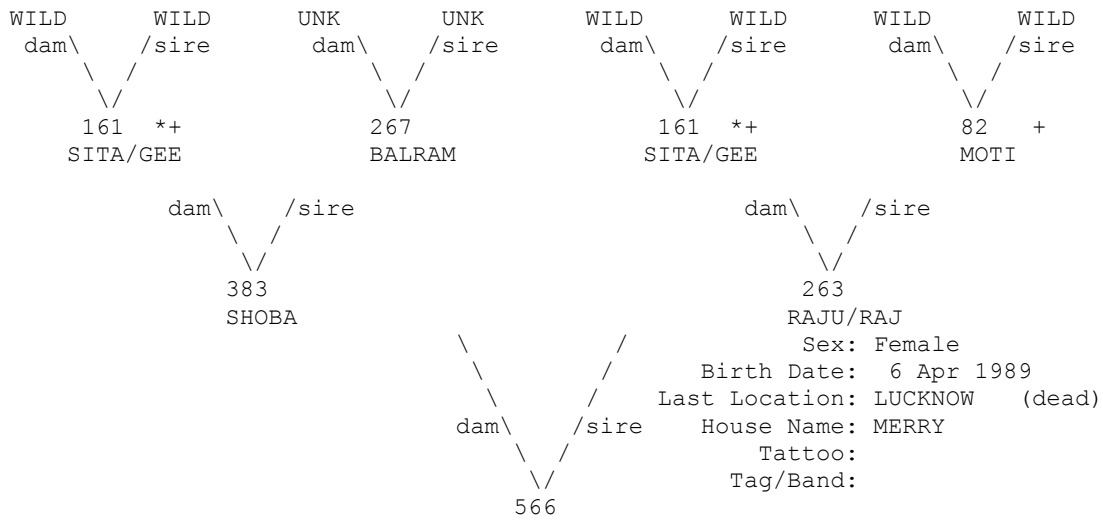

+ Wild-caught... * Appear more than once...

=====
 Taxon Name: PANTHERA TIGRIS Studbook Number: 567
 =====

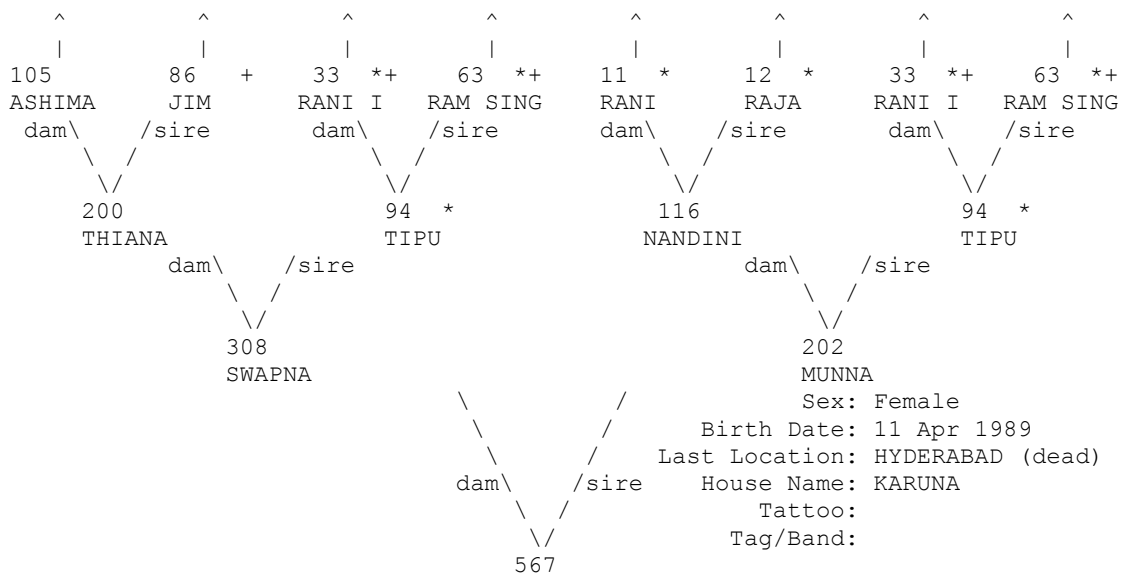

+ Wild-caught... * Appear more than once...

^ Pedigree continues beyond top of page...

=====
 Taxon Name: PANTHERA TIGRIS Studbook Number: 568
 =====

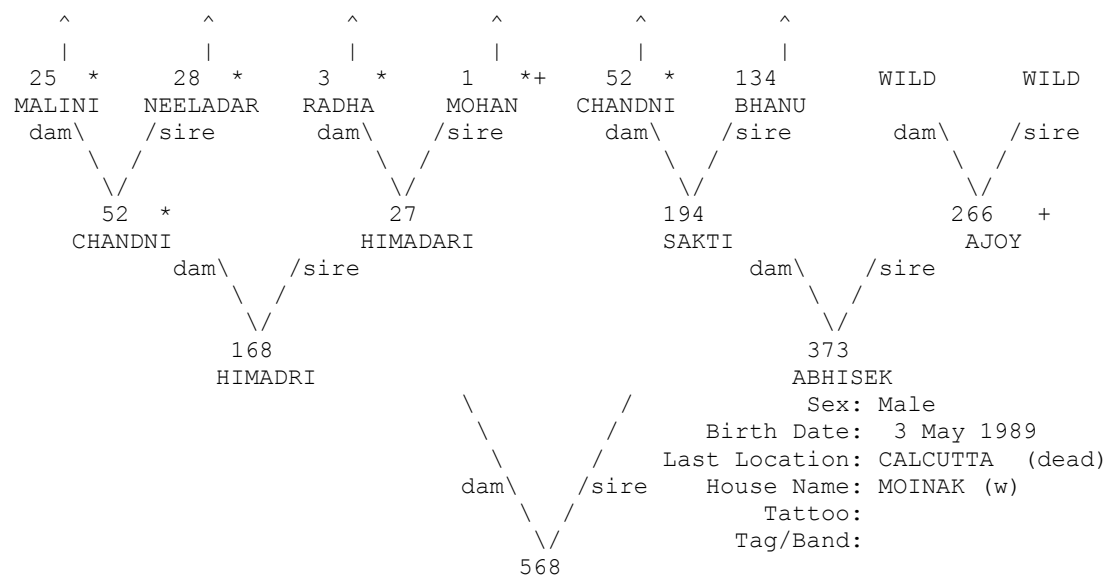

+ Wild-caught... * Appear more than once...
 ^ Pedigree continues beyond top of page...

=====
 Taxon Name: PANTHERA TIGRIS Studbook Number: 569
 =====

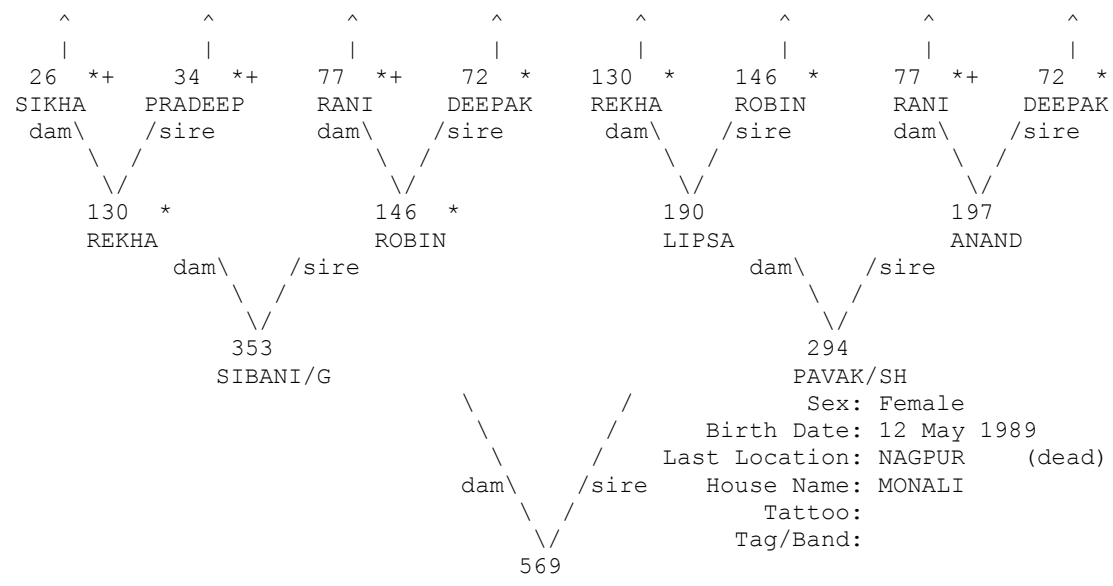

+ Wild-caught... * Appear more than once...
 ^ Pedigree continues beyond top of page...

=====
 Taxon Name: PANTHERA TIGRIS Studbook Number: 570
 =====

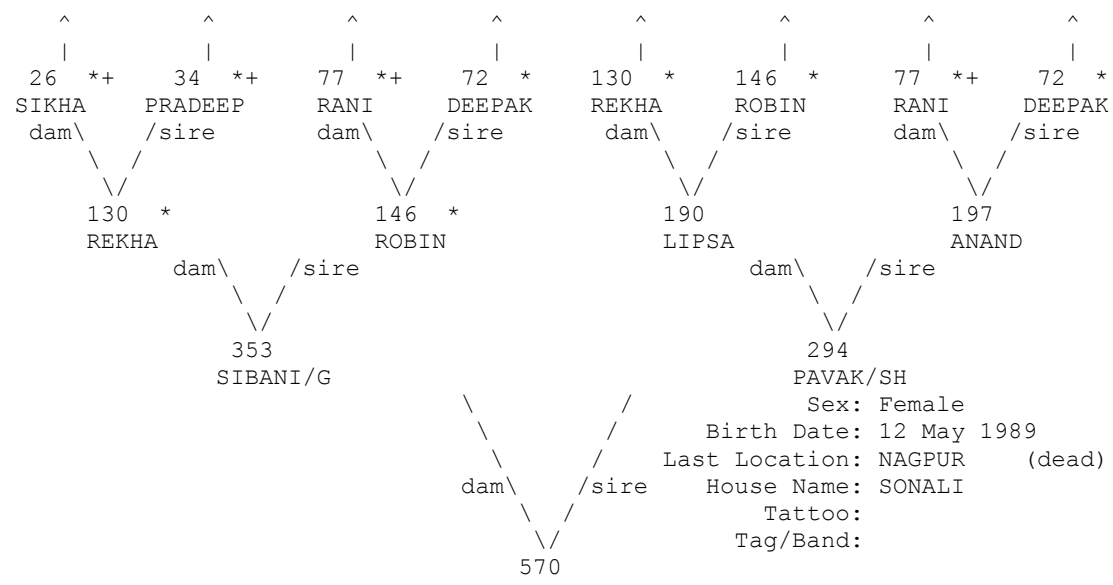

+ Wild-caught... * Appear more than once...
 ^ Pedigree continues beyond top of page...

=====
 Taxon Name: PANTHERA TIGRIS Studbook Number: 571
 =====

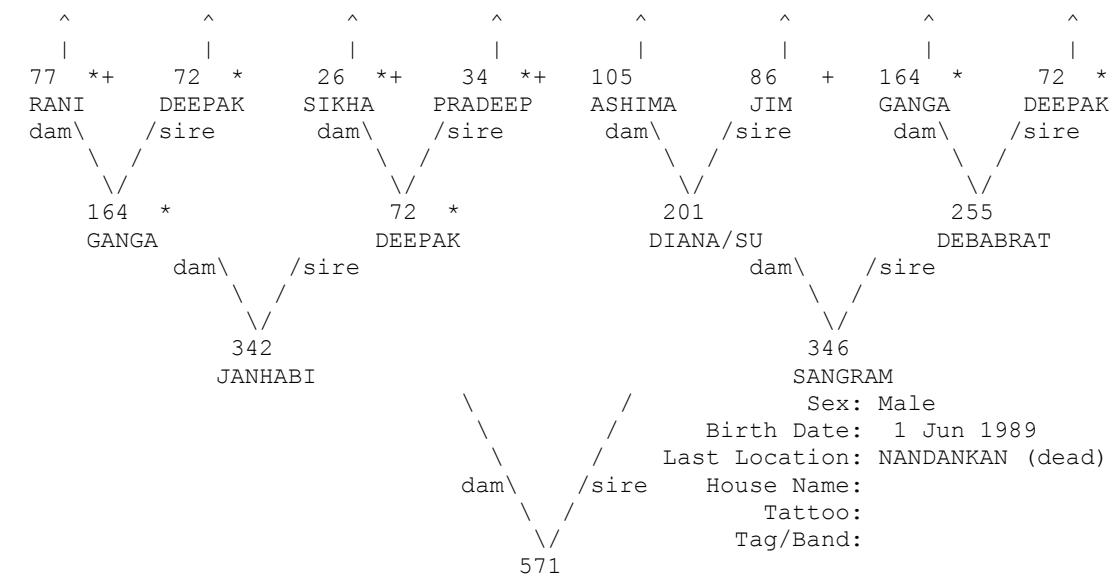

+ Wild-caught... * Appear more than once...
 ^ Pedigree continues beyond top of page...

=====
 Taxon Name: PANTHERA TIGRIS Studbook Number: 572
 =====

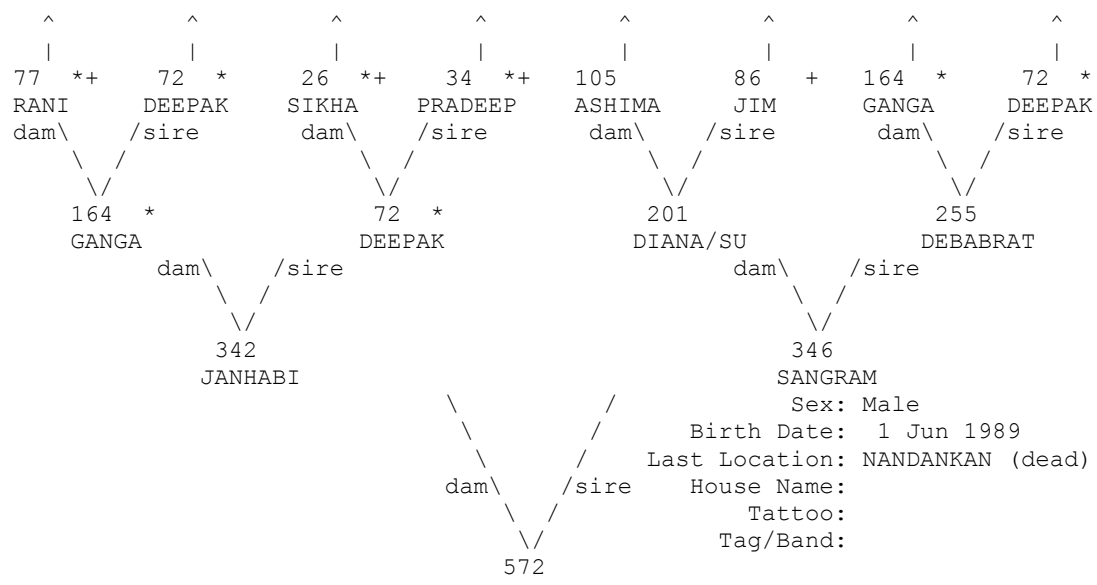

+ Wild-caught... * Appear more than once...
 ^ Pedigree continues beyond top of page...

=====
 Taxon Name: PANTHERA TIGRIS Studbook Number: 573
 =====

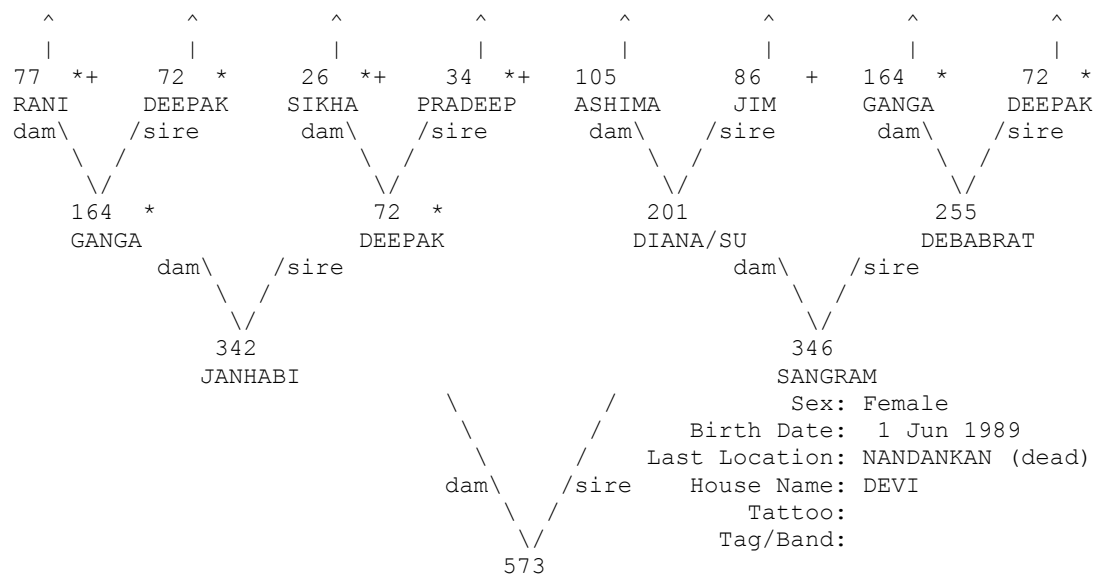

+ Wild-caught... * Appear more than once...
 ^ Pedigree continues beyond top of page...

=====
 Taxon Name: PANTHERA TIGRIS Studbook Number: 574
 =====

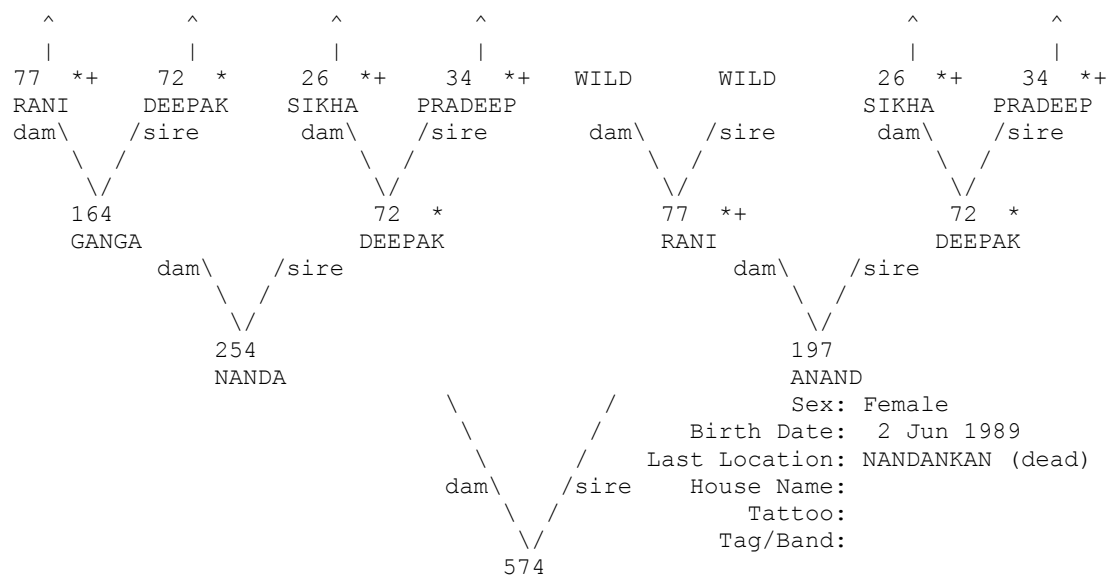

+ Wild-caught... * Appear more than once...
 ^ Pedigree continues beyond top of page...

=====
 Taxon Name: PANTHERA TIGRIS Studbook Number: 575
 =====

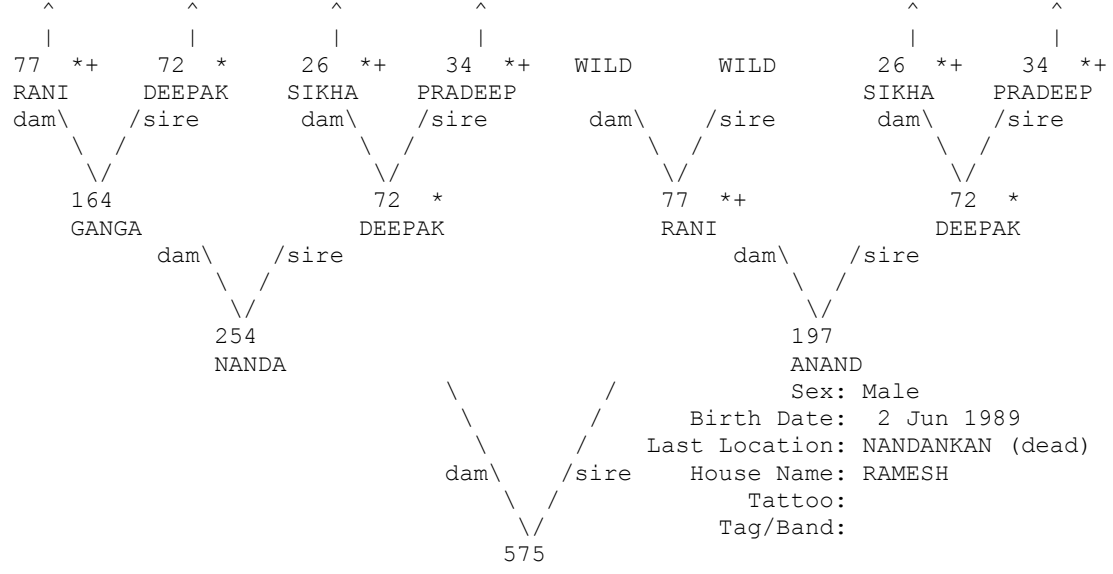

+ Wild-caught... * Appear more than once...
 ^ Pedigree continues beyond top of page...

=====
 Taxon Name: PANTHERA TIGRIS Studbook Number: 576
 =====

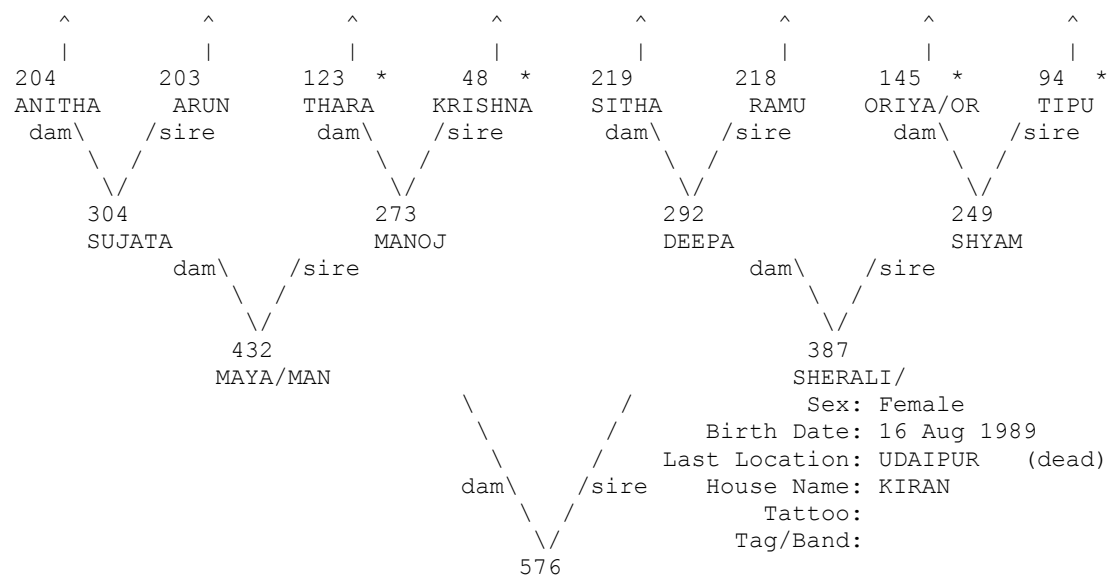

* Appear more than once...
 ^ Pedigree continues beyond top of page...

=====
 Taxon Name: PANTHERA TIGRIS Studbook Number: 577
 =====

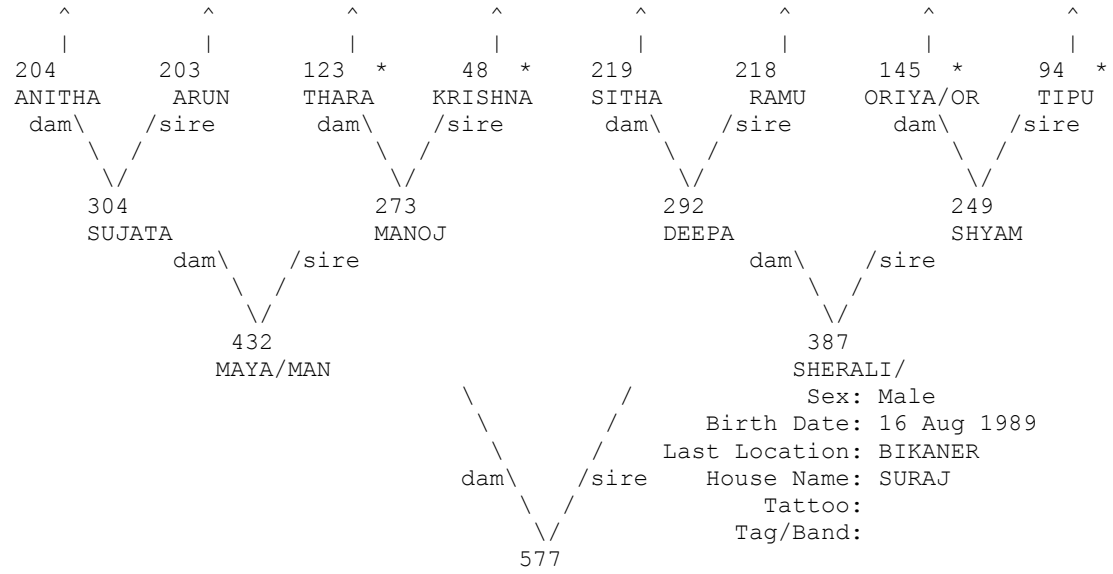

* Appear more than once...
 ^ Pedigree continues beyond top of page...

=====
 Taxon Name: PANTHERA TIGRIS Studbook Number: 578
 =====

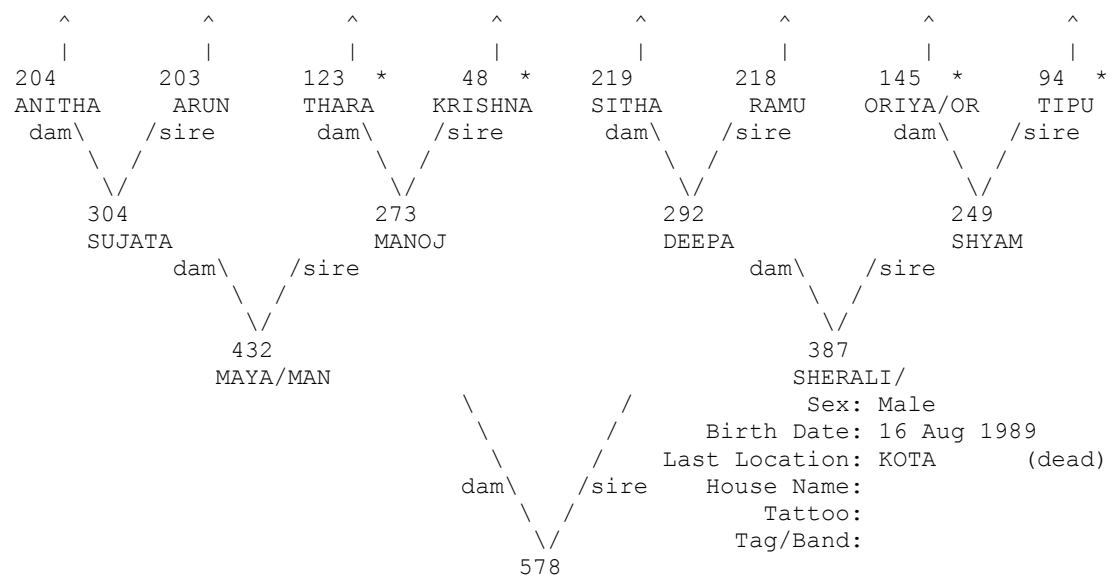

* Appear more than once...
 ^ Pedigree continues beyond top of page...

=====
 Taxon Name: PANTHERA TIGRIS Studbook Number: 579
 =====

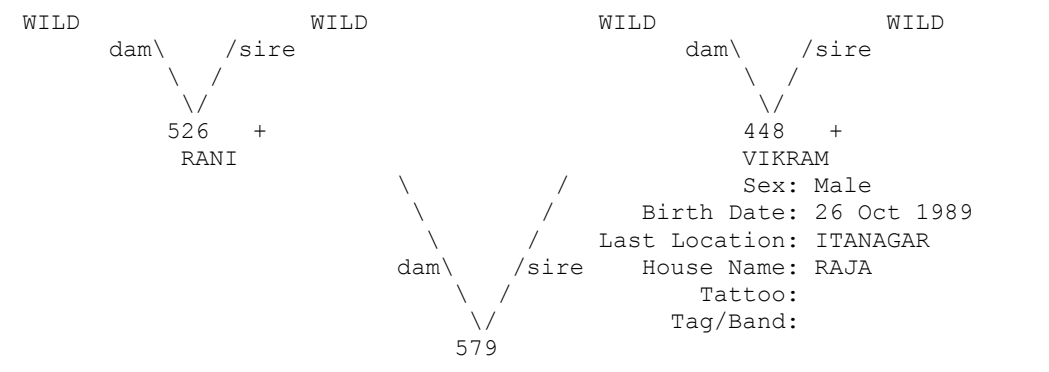

+ Wild-caught...

=====
 Taxon Name: PANTHERA TIGRIS Studbook Number: 580
 =====

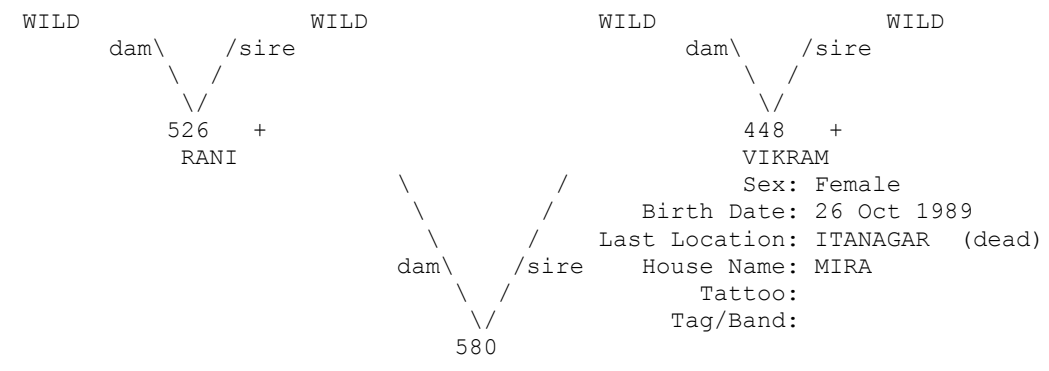

+ Wild-caught...

=====

Taxon Name: PANTHERA TIGRIS Studbook Number: 582

=====

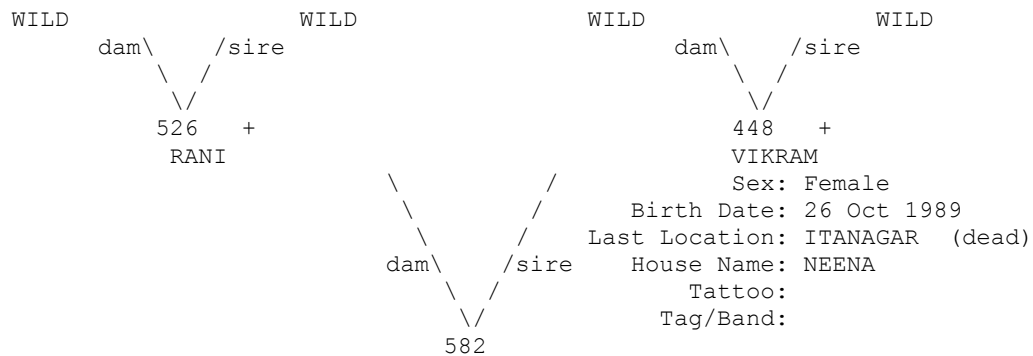

+ Wild-caught...

=====

Taxon Name: PANTHERA TIGRIS Studbook Number: 583

=====

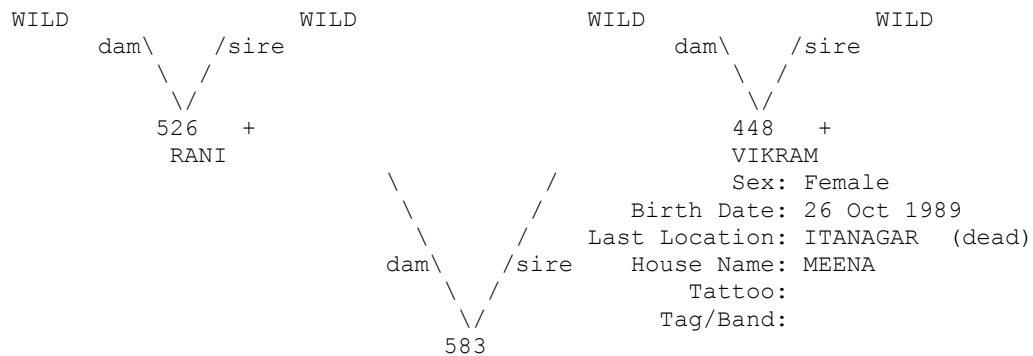

+ Wild-caught...

=====

Taxon Name: PANTHERA TIGRIS Studbook Number: 584

=====

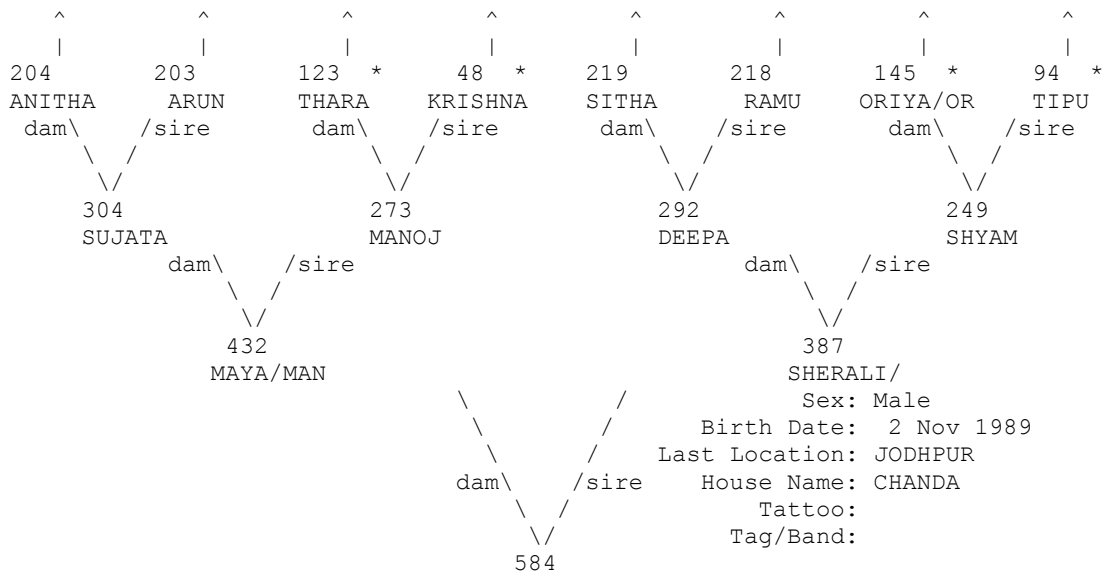

* Appear more than once...

^ Pedigree continues beyond top of page...

=====
 Taxon Name: PANTHERA TIGRIS Studbook Number: 585
 =====

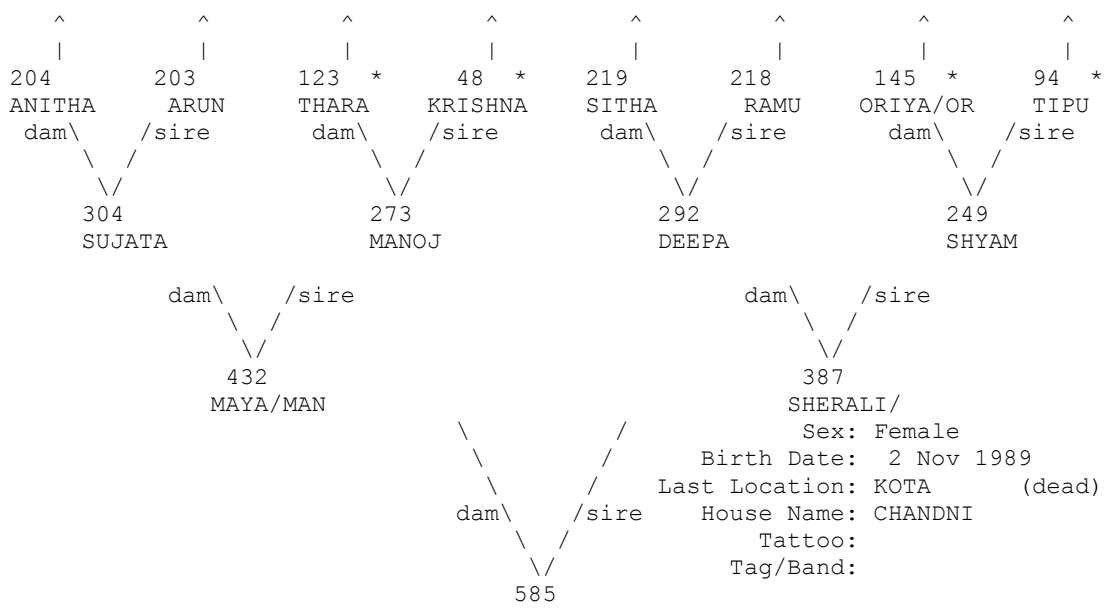

* Appear more than once...
 ^ Pedigree continues beyond top of page...

=====
 Taxon Name: PANTHERA TIGRIS Studbook Number: 586
 =====

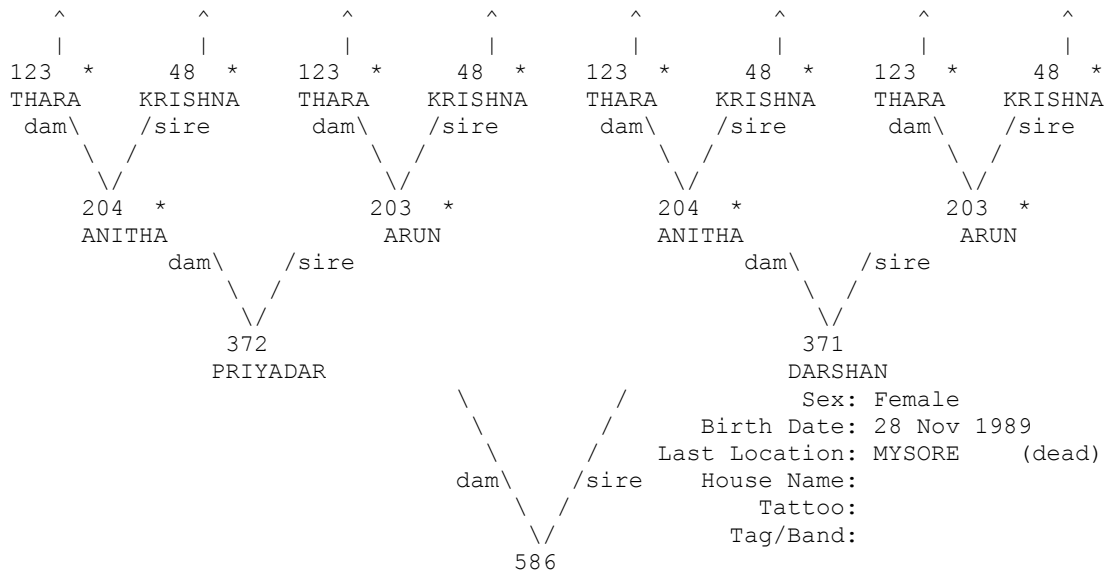

* Appear more than once...
 ^ Pedigree continues beyond top of page...

=====
 Taxon Name: PANTHERA TIGRIS Studbook Number: 587
 =====

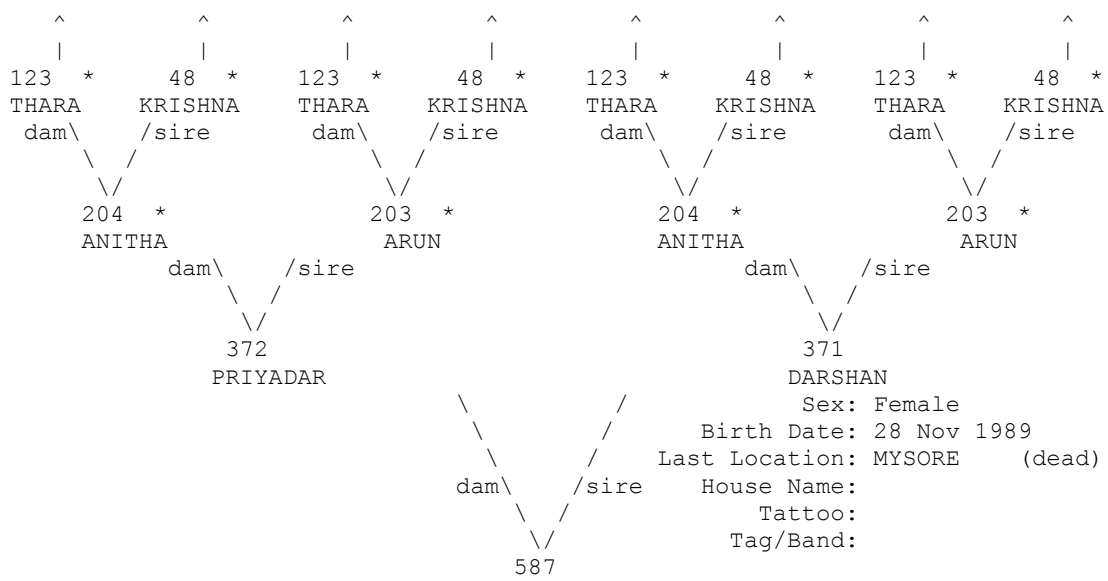

* Appear more than once...
 ^ Pedigree continues beyond top of page...

=====
 Taxon Name: PANTHERA TIGRIS Studbook Number: 588
 =====

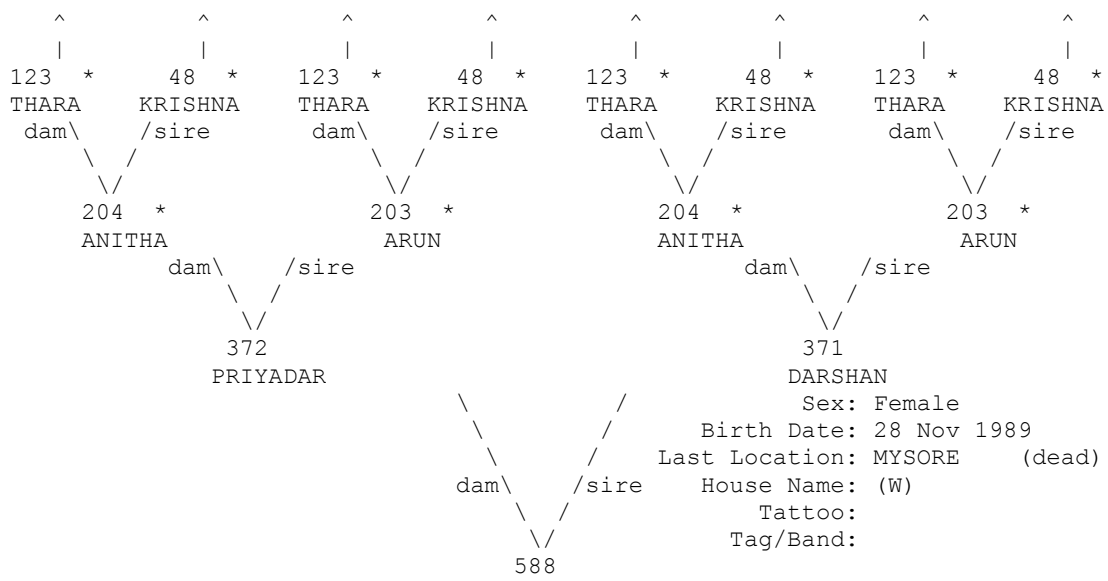

* Appear more than once...
 ^ Pedigree continues beyond top of page...

=====

Taxon Name: PANTHERA TIGRIS Studbook Number: 589

=====

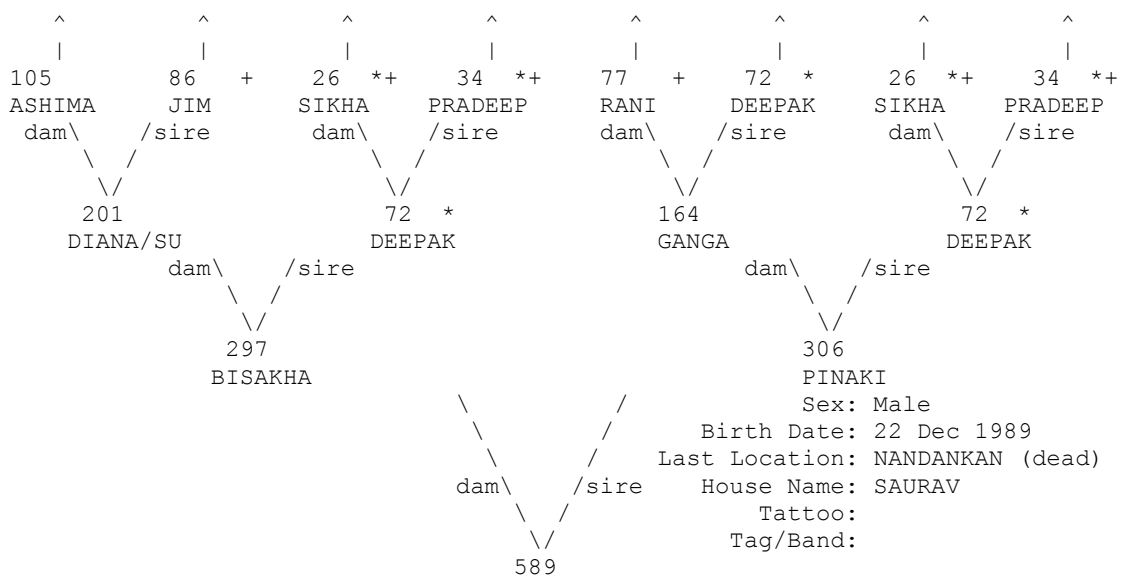

+ Wild-caught... * Appear more than once...
 ^ Pedigree continues beyond top of page...

=====

Taxon Name: PANTHERA TIGRIS Studbook Number: 590

=====

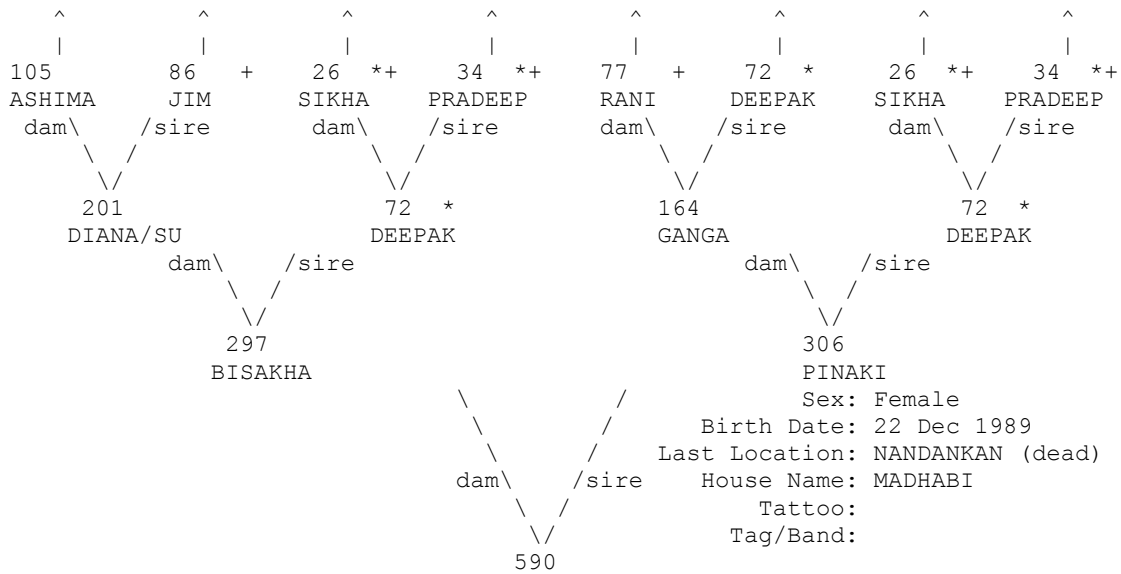

+ Wild-caught... * Appear more than once...
 ^ Pedigree continues beyond top of page...

=====
 Taxon Name: PANTHERA TIGRIS Studbook Number: 591
 =====

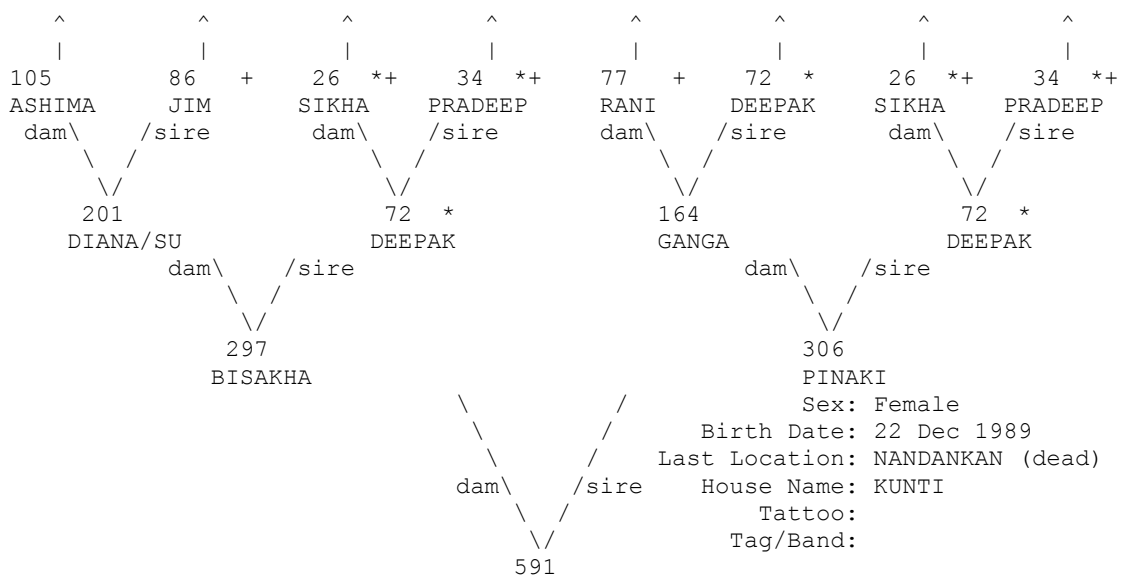

+ Wild-caught... * Appear more than once...
 ^ Pedigree continues beyond top of page...

=====
 Taxon Name: PANTHERA TIGRIS Studbook Number: 592
 =====

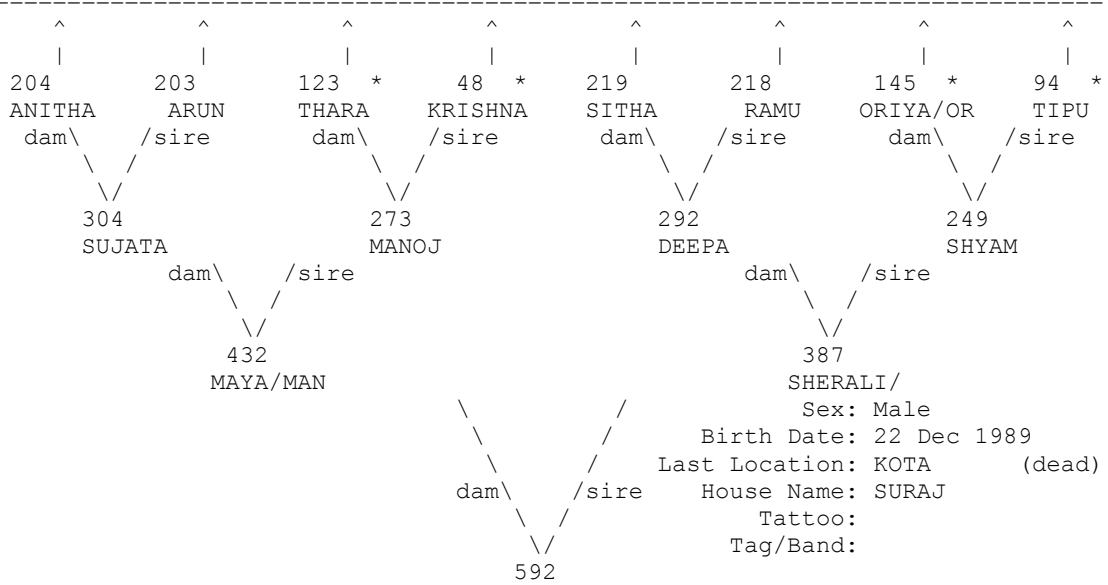

* Appear more than once...
 ^ Pedigree continues beyond top of page...

=====
 Taxon Name: PANTHERA TIGRIS Studbook Number: 596
 =====

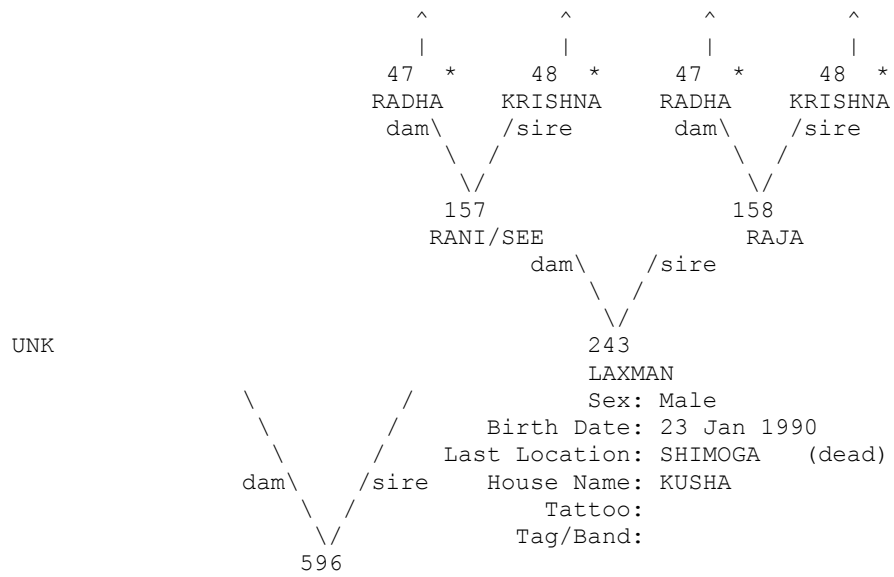

* Appear more than once...
 ^ Pedigree continues beyond top of page...

=====
 Taxon Name: PANTHERA TIGRIS Studbook Number: 597
 =====

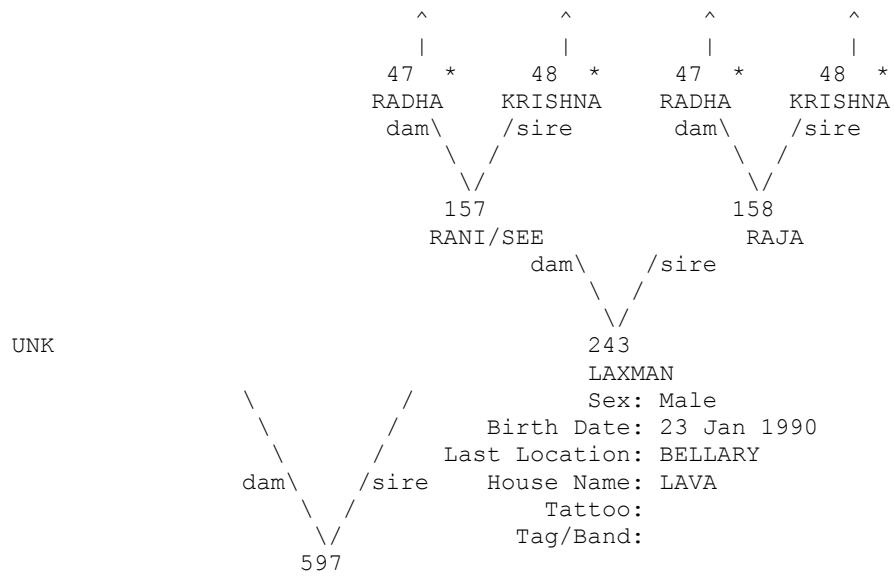

* Appear more than once...
 ^ Pedigree continues beyond top of page...

=====
 Taxon Name: PANTHERA TIGRIS Studbook Number: 598
 =====

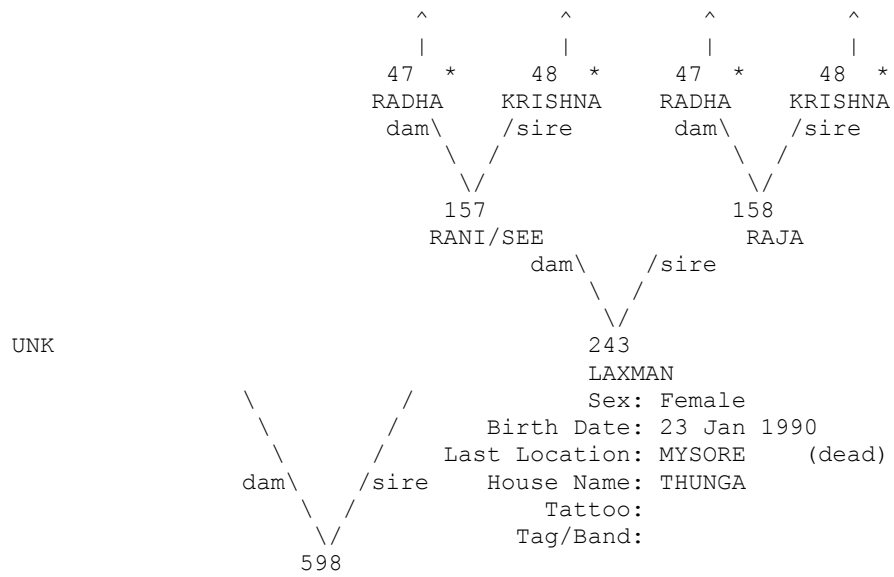

* Appear more than once...
 ^ Pedigree continues beyond top of page...

=====
 Taxon Name: PANTHERA TIGRIS Studbook Number: 599
 =====

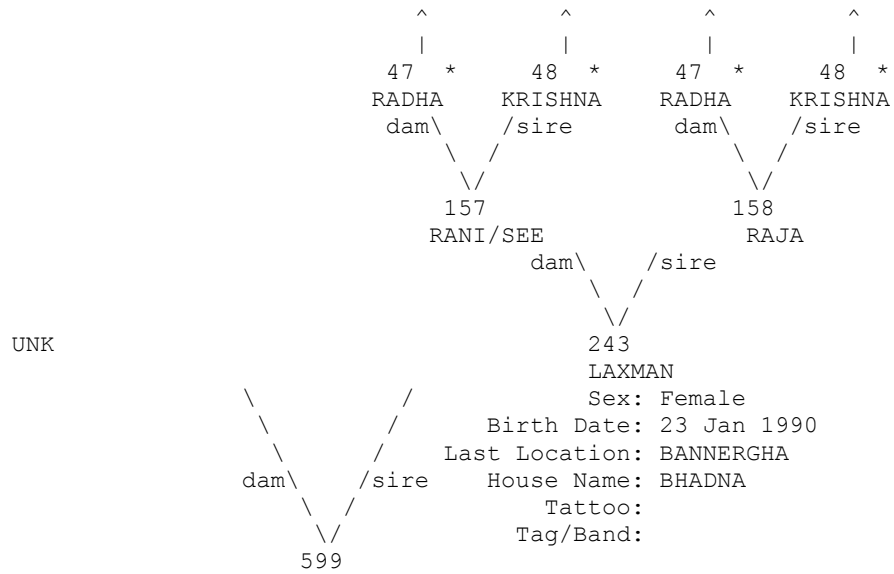

* Appear more than once...
 ^ Pedigree continues beyond top of page...

```

=====
Taxon Name: PANTHERA TIGRIS                      Studbook Number: 600
=====
UNK                                               UNK
                                                Sex: Male
                                                Birth Date: 28 Feb 1990
                                                Last Location: TRICHUR (dead)
dam \      /sire                               House Name:
      \    /                                   Tattoo:
       \  /                                    Tag/Band:
        \ /
         V
        600

```

```

=====
Taxon Name: PANTHERA TIGRIS                      Studbook Number: 601
=====
UNK                                               UNK
                                                Sex: Male
                                                Birth Date: 28 Feb 1990
                                                Last Location: TRICHUR (dead)
dam \      /sire                               House Name:
      \    /                                   Tattoo:
       \  /                                    Tag/Band:
        \ /
         V
        601

```

```

=====
Taxon Name: PANTHERA TIGRIS                      Studbook Number: 602
=====
UNK                                               UNK
                                                Sex: Female
                                                Birth Date: 28 Feb 1990
                                                Last Location: TRIVANDRU (dead)
dam \      /sire                               House Name: RANI
      \    /                                   Tattoo:
       \  /                                    Tag/Band:
        \ /
         V
        602

```

```

=====
Taxon Name: PANTHERA TIGRIS                      Studbook Number: 603
=====
WILD                                             WILD
                                                Sex: Female
                                                Birth Date: ~ 1990
                                                Last Location: PATNA (dead)
dam \      /sire                               House Name: MOHINI
      \    /                                   Tattoo:
       \  /                                    Tag/Band:
        \ /
         V
        603

```

```

=====
Taxon Name: PANTHERA TIGRIS                      Studbook Number: 604
=====
WILD                                             WILD
                                                Sex: Female
                                                Birth Date: ~ 1979
                                                Last Location: HYDERABAD (dead)
dam \      /sire                               House Name: MYNA
      \    /                                   Tattoo:
       \  /                                    Tag/Band:
        \ /
         V
        604

```

=====
 Taxon Name: PANTHERA TIGRIS Studbook Number: 605
 =====

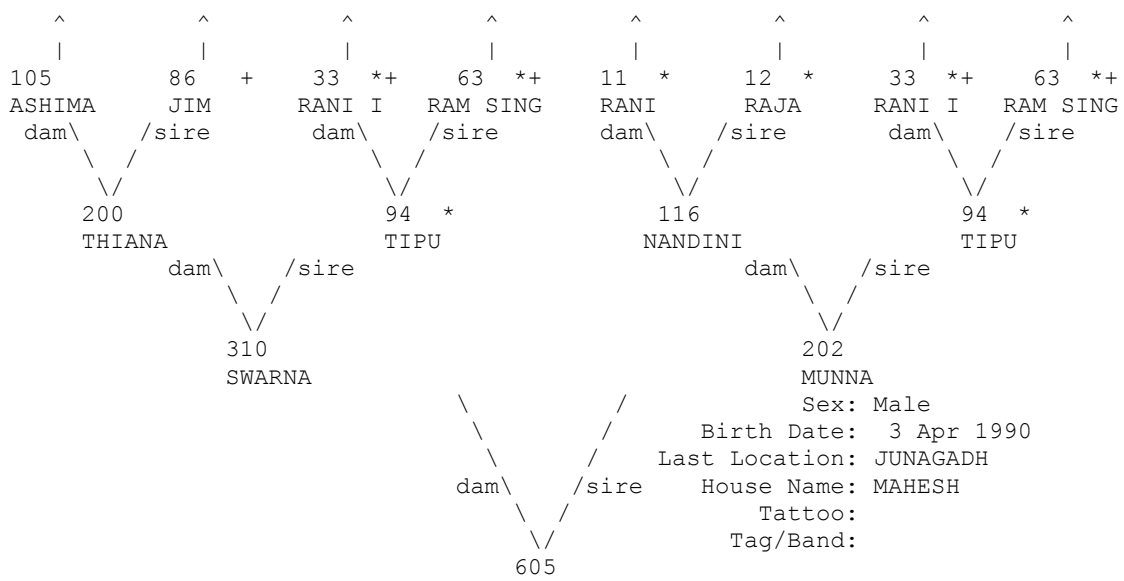

+ Wild-caught... * Appear more than once...
 ^ Pedigree continues beyond top of page...

=====
 Taxon Name: PANTHERA TIGRIS Studbook Number: 606
 =====

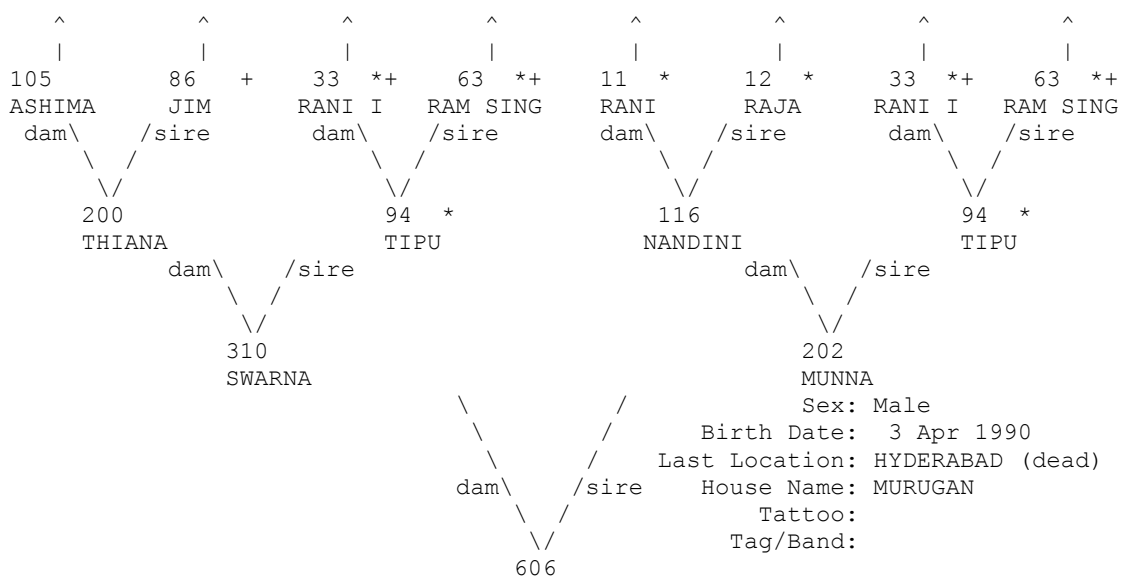

+ Wild-caught... * Appear more than once...
 ^ Pedigree continues beyond top of page...

=====
 Taxon Name: PANTHERA TIGRIS Studbook Number: 607
 =====

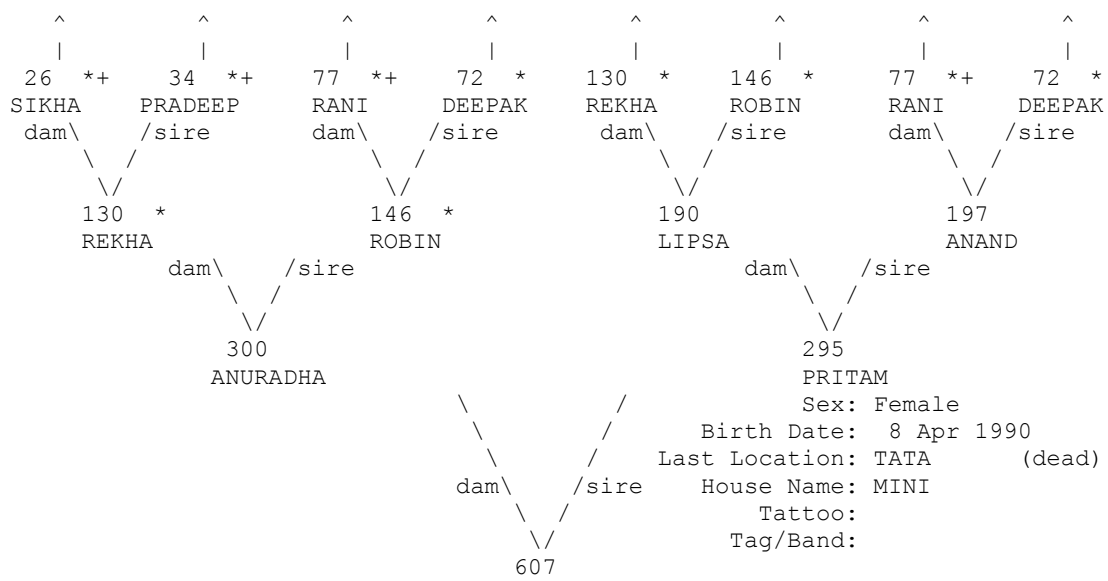

+ Wild-caught... * Appear more than once...
 ^ Pedigree continues beyond top of page...

=====
 Taxon Name: PANTHERA TIGRIS Studbook Number: 608
 =====

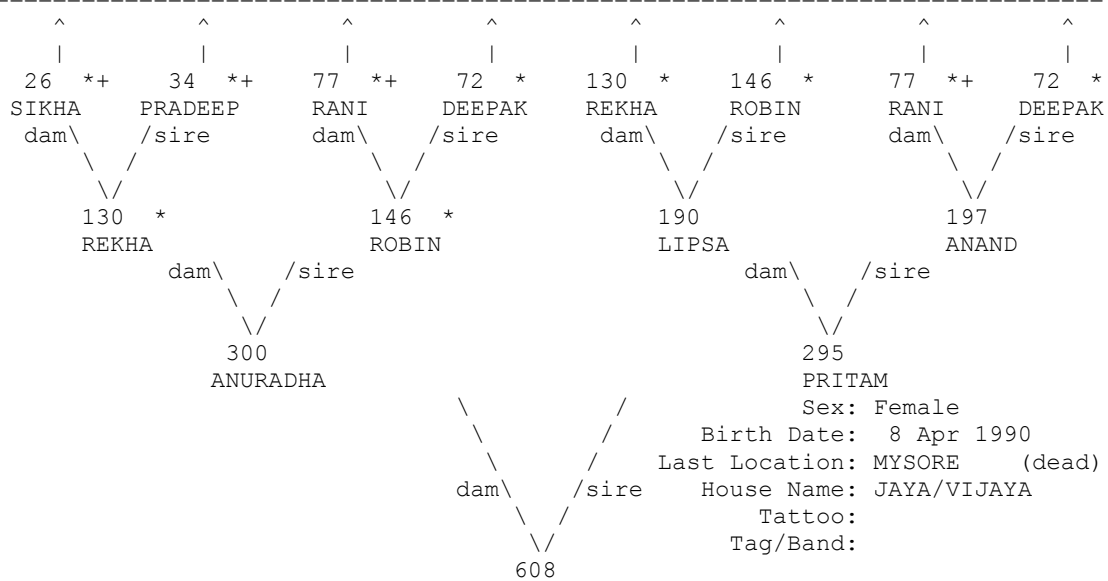

+ Wild-caught... * Appear more than once...
 ^ Pedigree continues beyond top of page...

=====
 Taxon Name: PANTHERA TIGRIS Studbook Number: 609
 =====

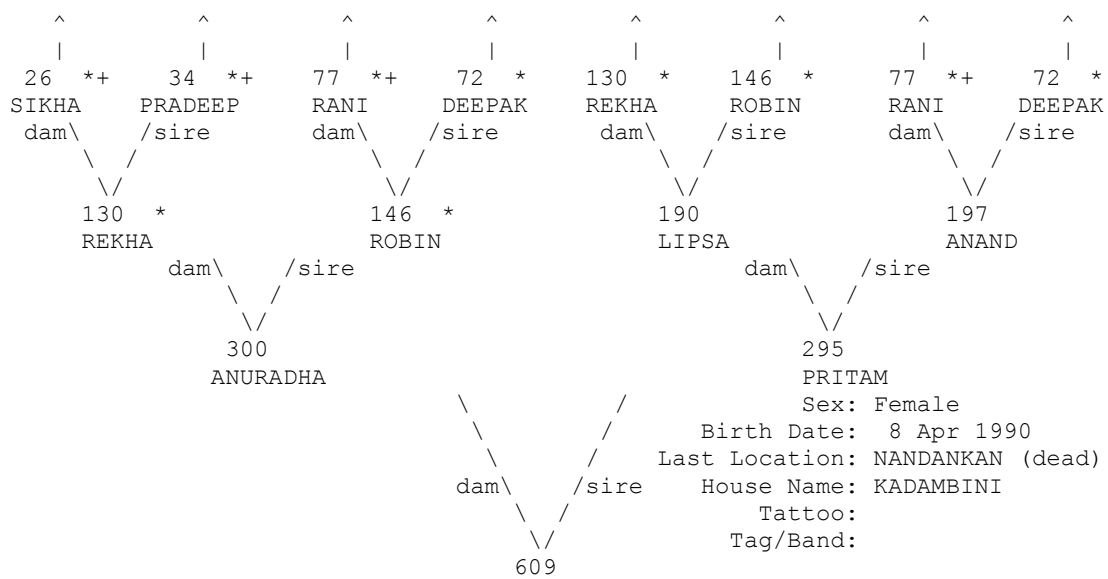

+ Wild-caught... * Appear more than once...
 ^ Pedigree continues beyond top of page...

=====
 Taxon Name: PANTHERA TIGRIS Studbook Number: 610
 =====

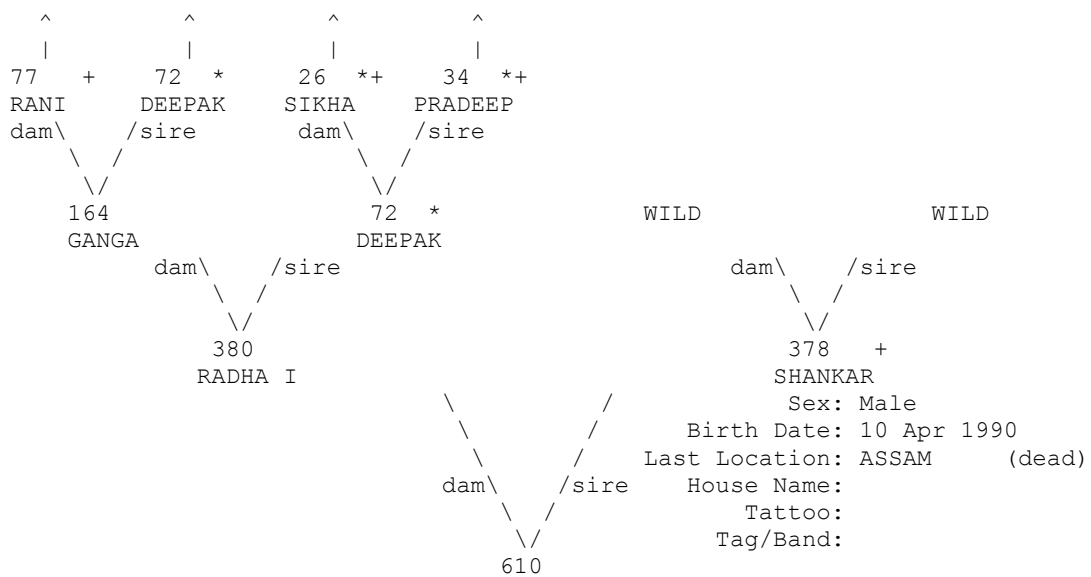

+ Wild-caught... * Appear more than once...
 ^ Pedigree continues beyond top of page...

=====
 Taxon Name: PANTHERA TIGRIS Studbook Number: 611
 =====

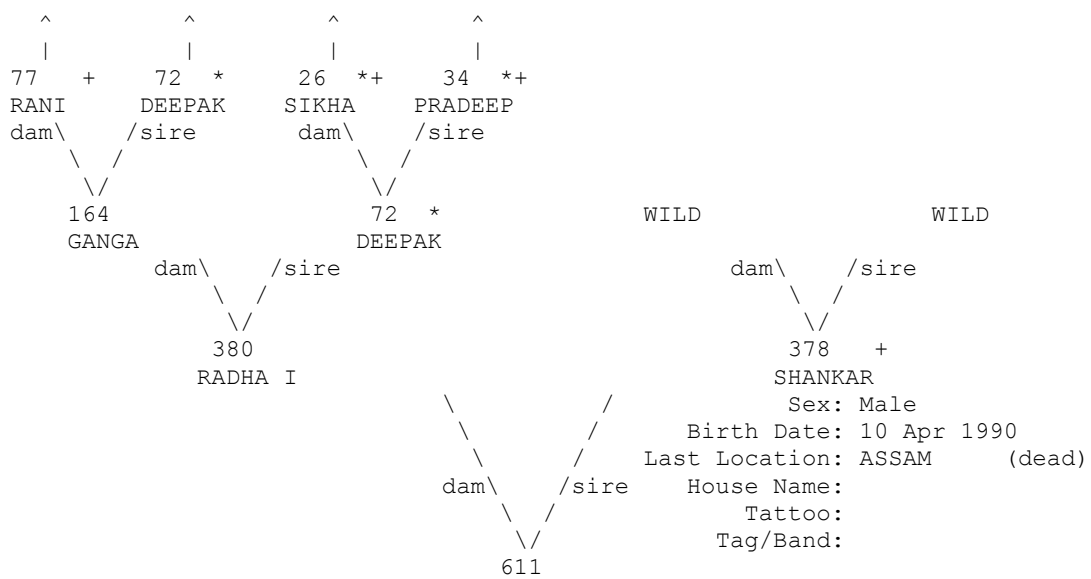

+ Wild-caught... * Appear more than once...
 ^ Pedigree continues beyond top of page...

=====
 Taxon Name: PANTHERA TIGRIS Studbook Number: 612
 =====

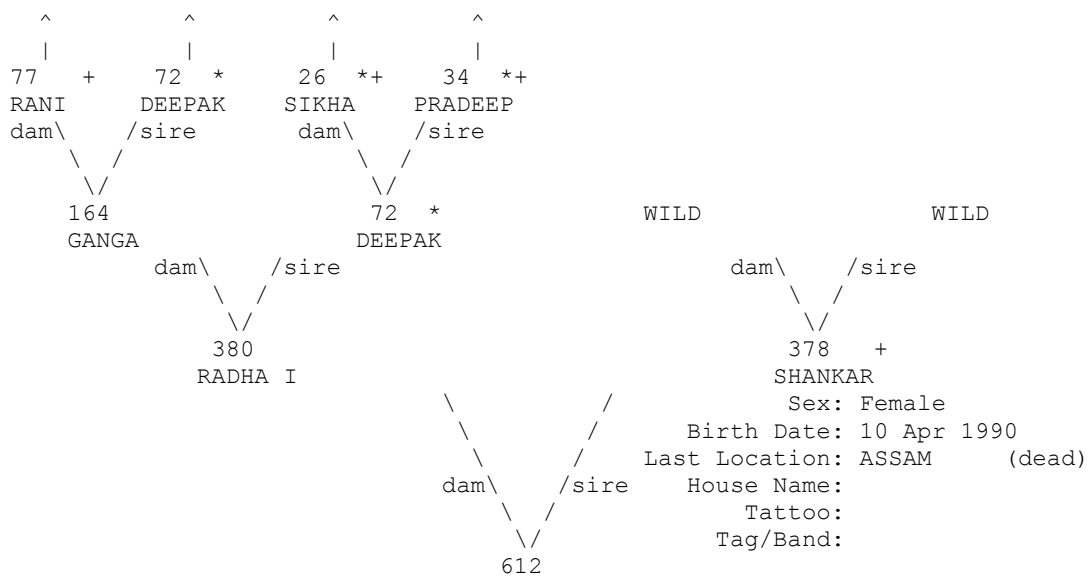

+ Wild-caught... * Appear more than once...
 ^ Pedigree continues beyond top of page...

=====
 Taxon Name: PANTHERA TIGRIS Studbook Number: 615
 =====

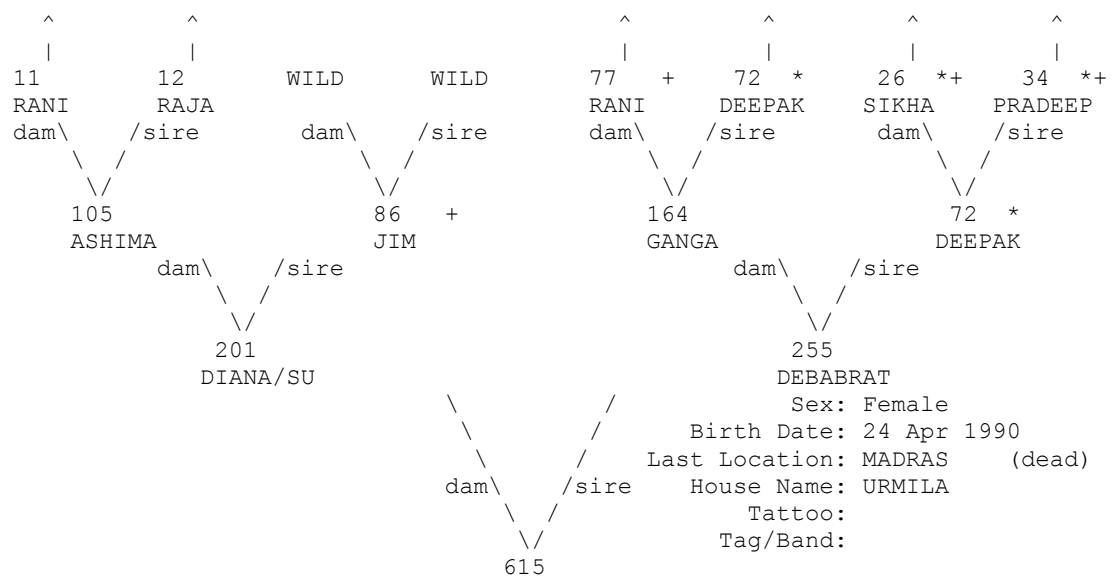

+ Wild-caught... * Appear more than once...
 ^ Pedigree continues beyond top of page...

=====
 Taxon Name: PANTHERA TIGRIS Studbook Number: 616
 =====

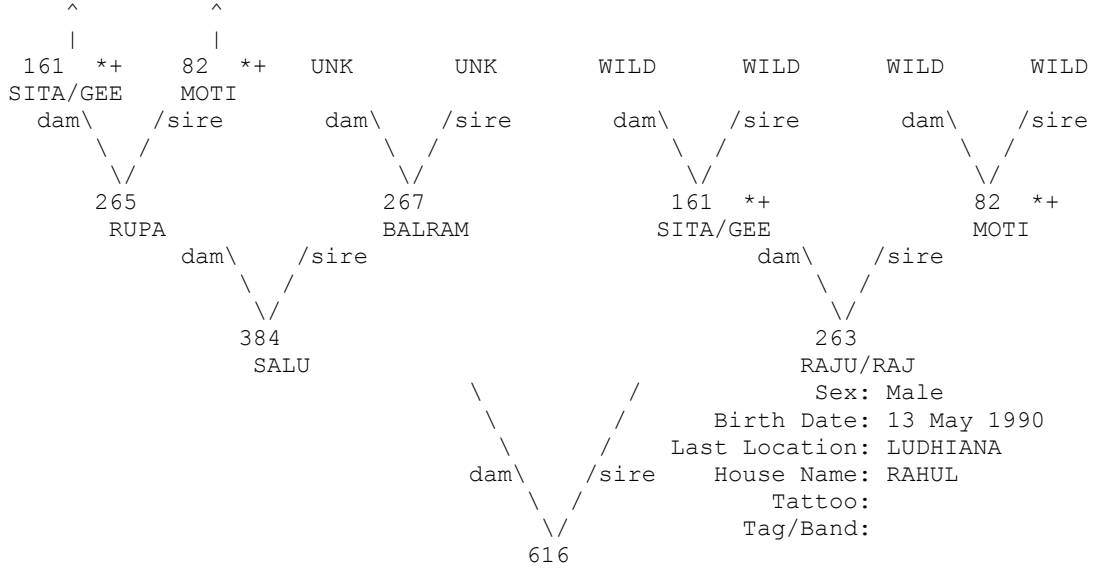

+ Wild-caught... * Appear more than once...
 ^ Pedigree continues beyond top of page...

=====
 Taxon Name: PANTHERA TIGRIS Studbook Number: 617
 =====

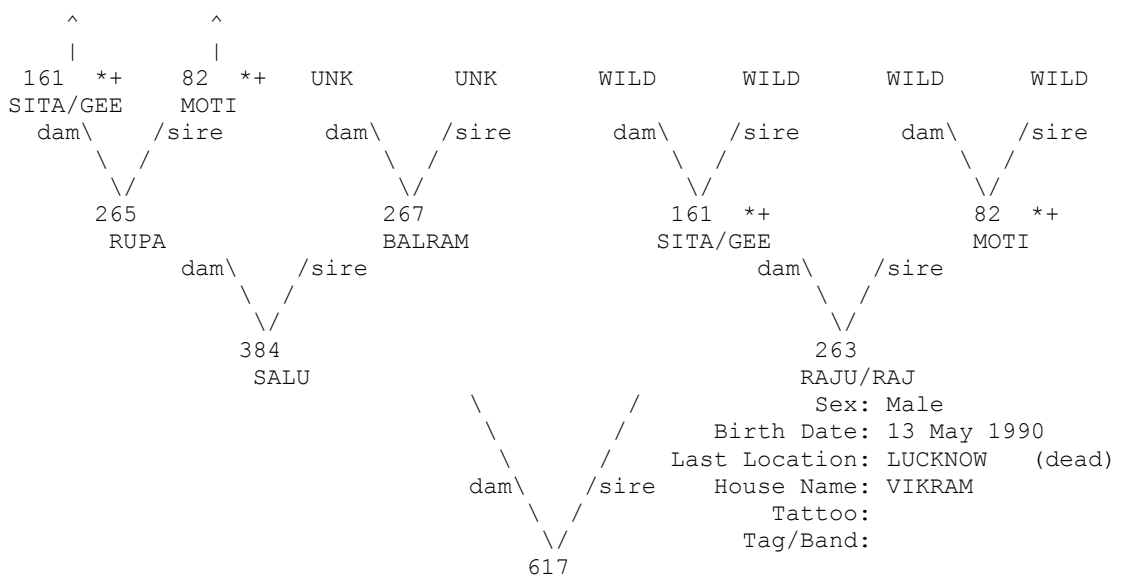

+ Wild-caught... * Appear more than once...
 ^ Pedigree continues beyond top of page...

=====
 Taxon Name: PANTHERA TIGRIS Studbook Number: 618
 =====

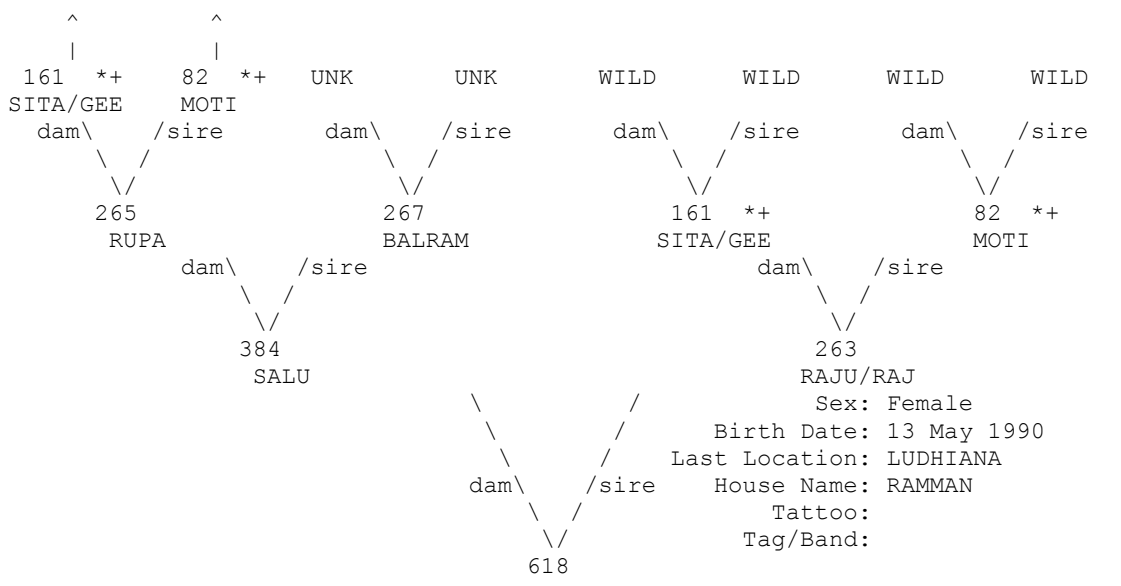

+ Wild-caught... * Appear more than once...
 ^ Pedigree continues beyond top of page...

=====
 Taxon Name: PANTHERA TIGRIS Studbook Number: 619
 =====

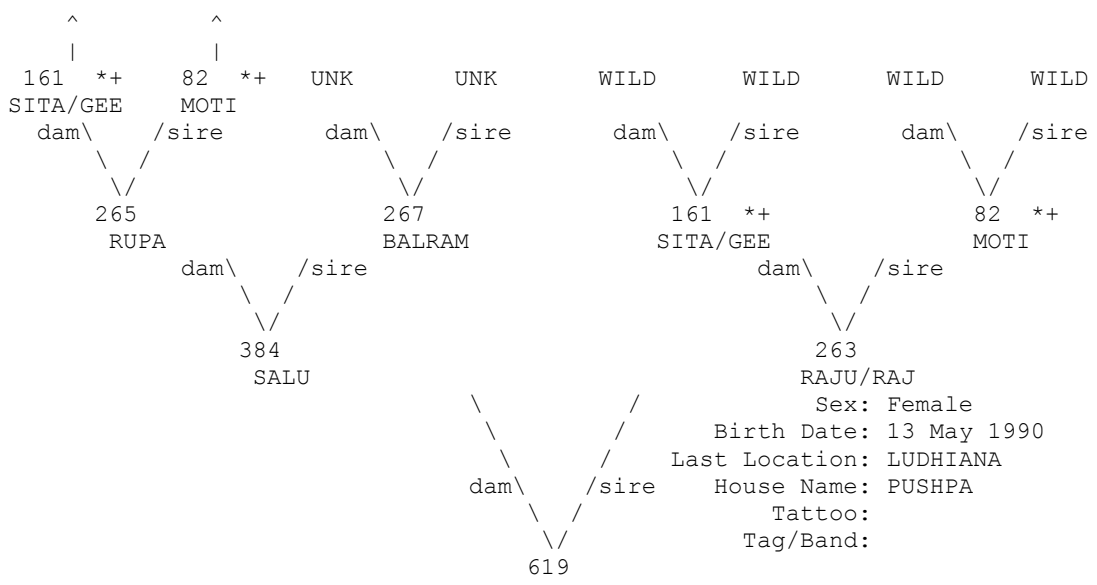

+ Wild-caught... * Appear more than once...
 ^ Pedigree continues beyond top of page...

=====
 Taxon Name: PANTHERA TIGRIS Studbook Number: 620
 =====

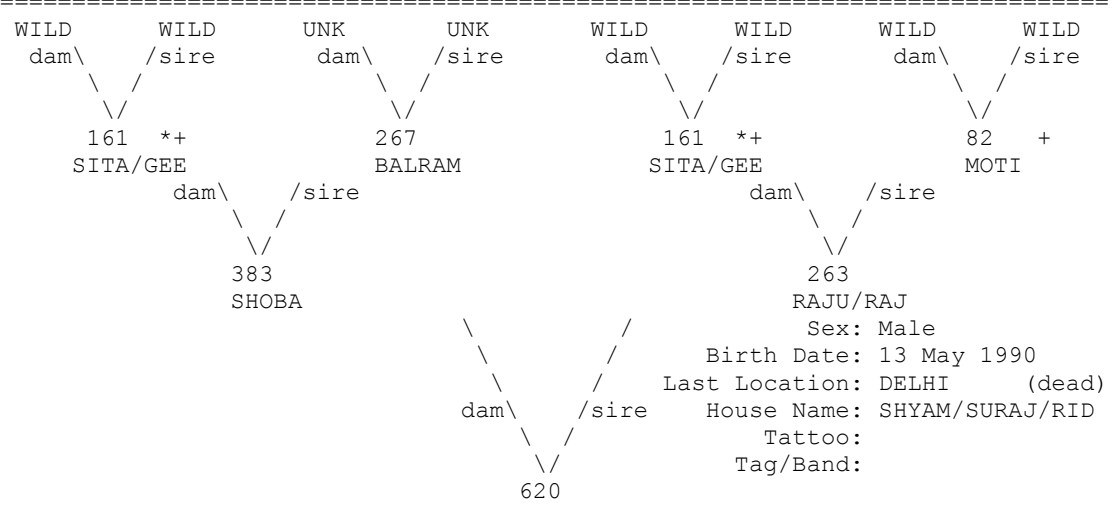

+ Wild-caught... * Appear more than once...

=====
 Taxon Name: PANTHERA TIGRIS Studbook Number: 621
 =====

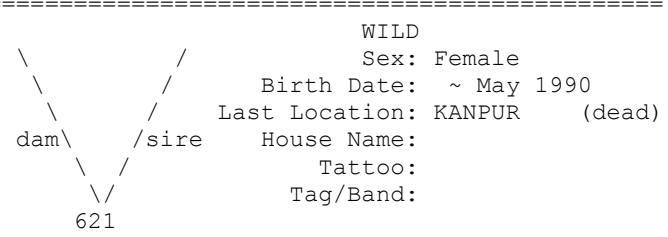

=====
 Taxon Name: PANTHERA TIGRIS Studbook Number: 622
 =====

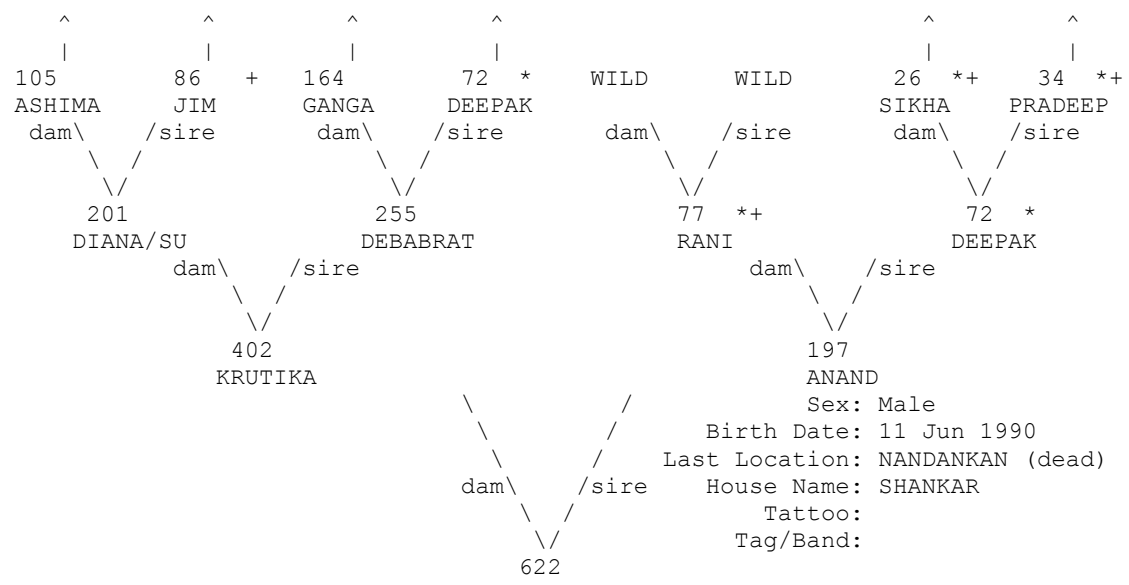

+ Wild-caught... * Appear more than once...
 ^ Pedigree continues beyond top of page...

=====
 Taxon Name: PANTHERA TIGRIS Studbook Number: 623
 =====

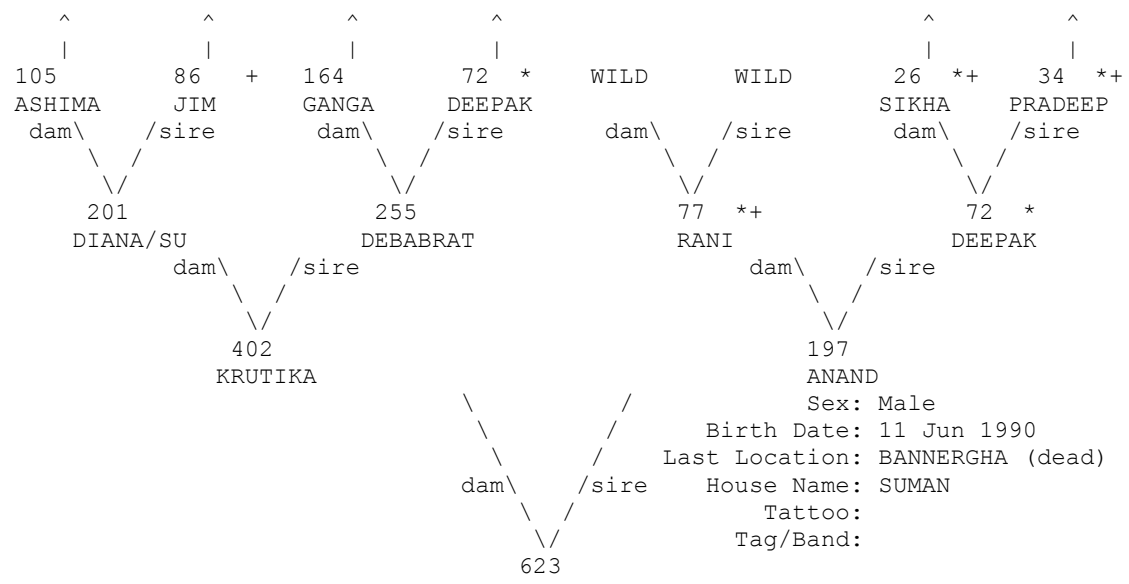

+ Wild-caught... * Appear more than once...
 ^ Pedigree continues beyond top of page...

=====
 Taxon Name: PANTHERA TIGRIS Studbook Number: 624
 =====

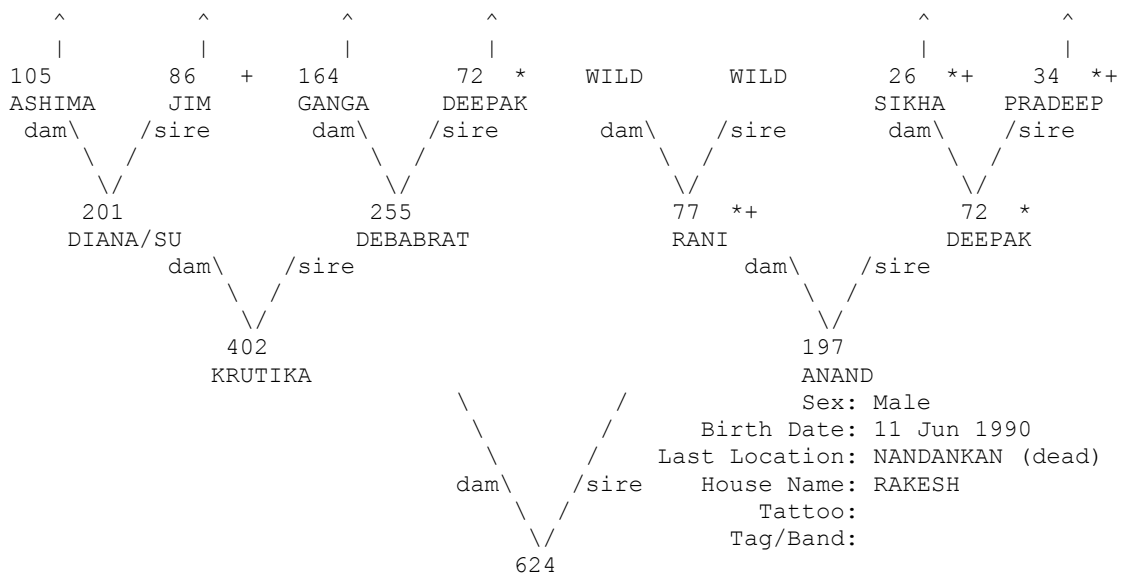

+ Wild-caught... * Appear more than once...
 ^ Pedigree continues beyond top of page...

=====
 Taxon Name: PANTHERA TIGRIS Studbook Number: 625
 =====

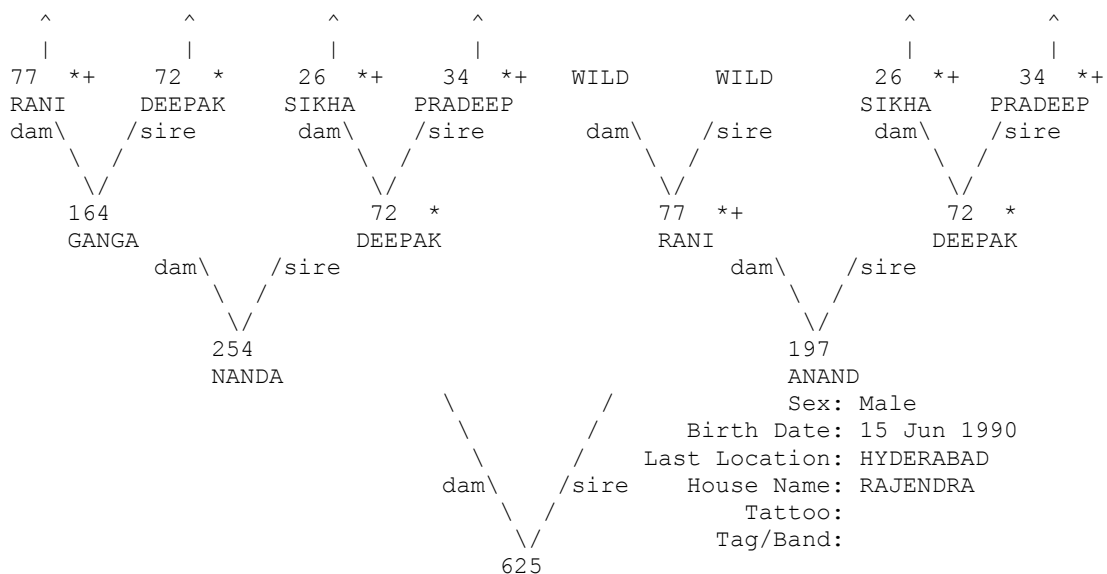

+ Wild-caught... * Appear more than once...
 ^ Pedigree continues beyond top of page...

=====
 Taxon Name: PANTHERA TIGRIS Studbook Number: 626
 =====

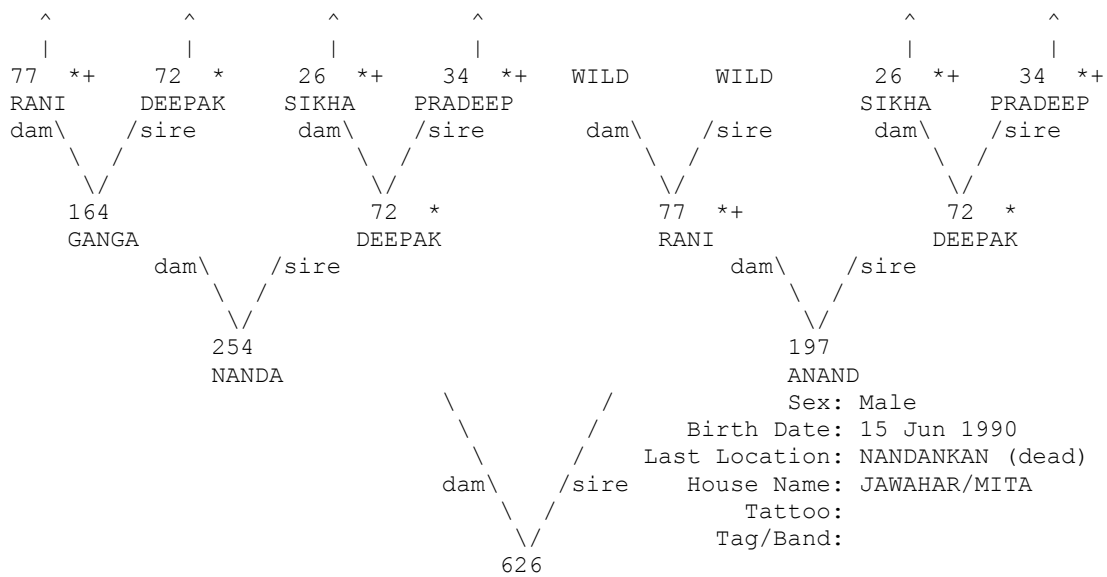

+ Wild-caught... * Appear more than once...
 ^ Pedigree continues beyond top of page...

=====
 Taxon Name: PANTHERA TIGRIS Studbook Number: 627
 =====

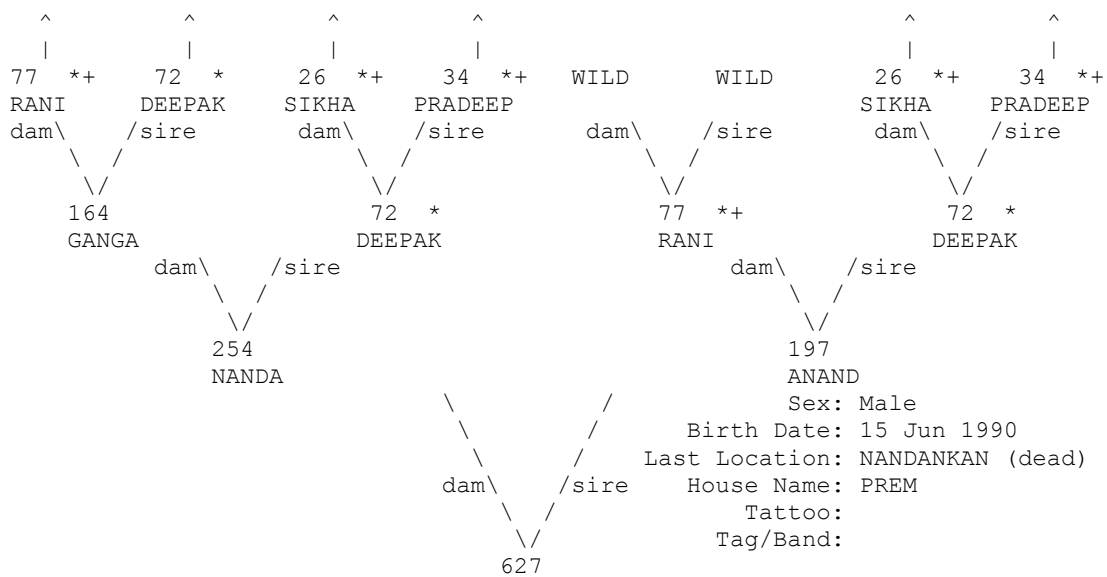

+ Wild-caught... * Appear more than once...
 ^ Pedigree continues beyond top of page...

=====
 Taxon Name: PANTHERA TIGRIS Studbook Number: 630
 =====

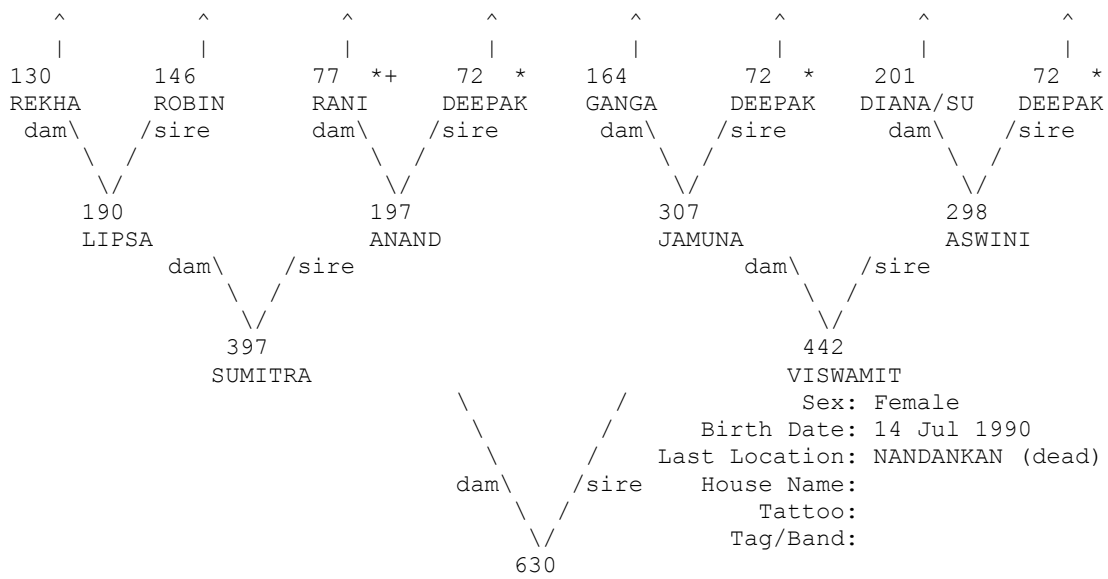

+ Wild-caught... * Appear more than once...
 ^ Pedigree continues beyond top of page...

=====
 Taxon Name: PANTHERA TIGRIS Studbook Number: 631
 =====

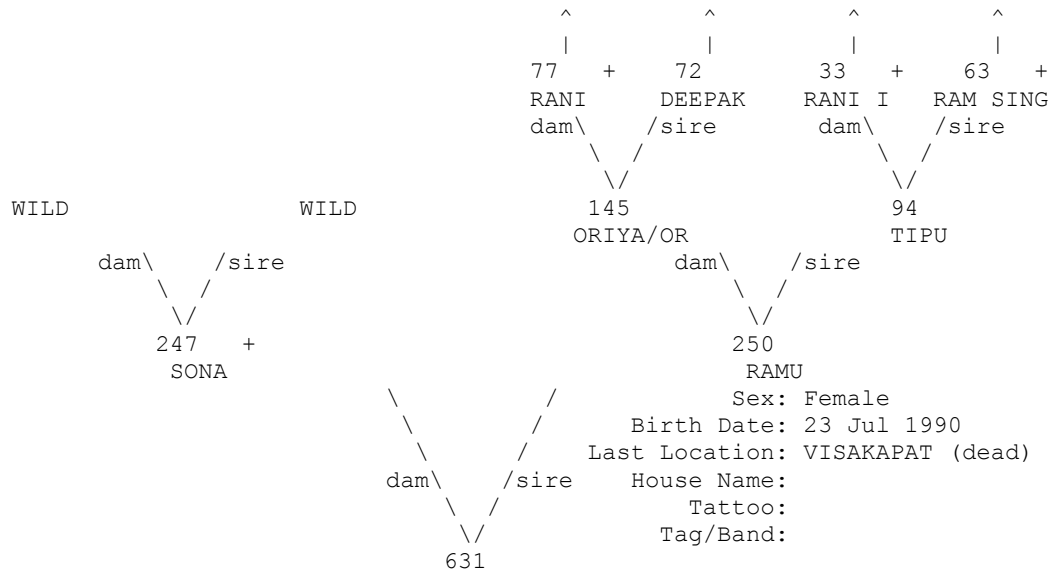

+ Wild-caught...
 ^ Pedigree continues beyond top of page...

=====
 Taxon Name: PANTHERA TIGRIS Studbook Number: 632
 =====

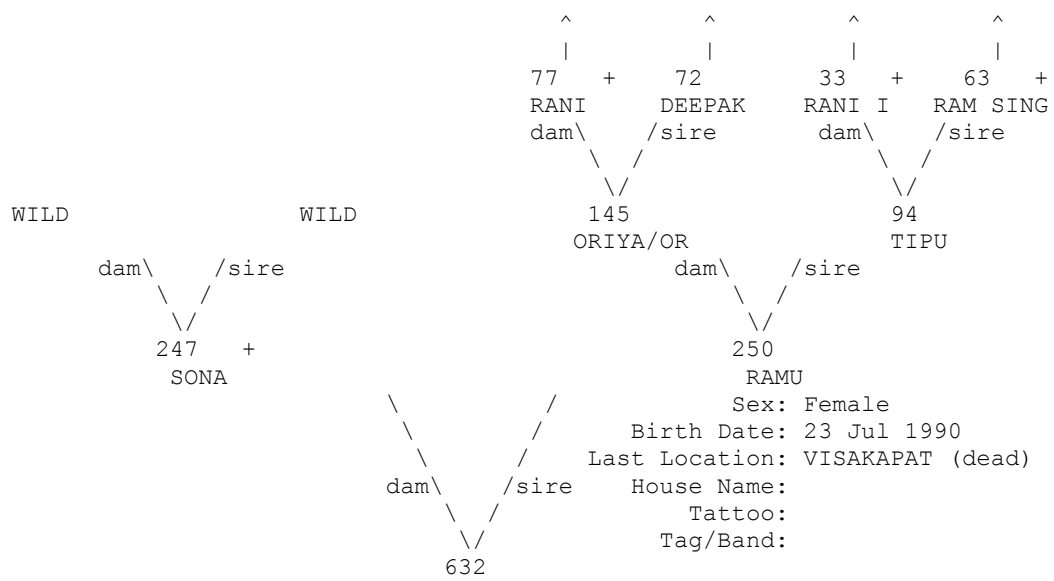

+ Wild-caught...
 ^ Pedigree continues beyond top of page...

=====
 Taxon Name: PANTHERA TIGRIS Studbook Number: 633
 =====

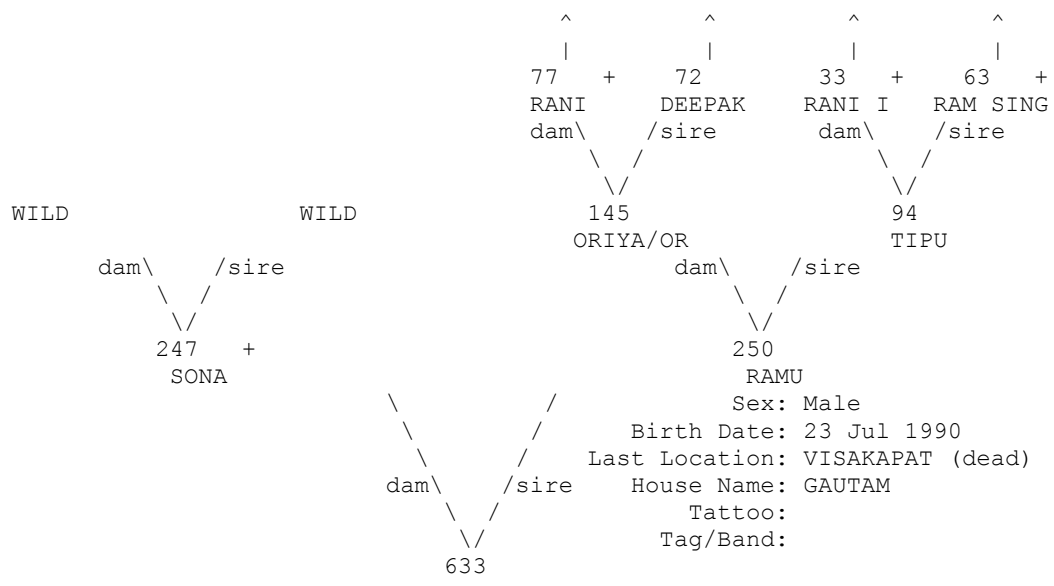

+ Wild-caught...
 ^ Pedigree continues beyond top of page...

=====
 Taxon Name: PANTHERA TIGRIS Studbook Number: 634
 =====

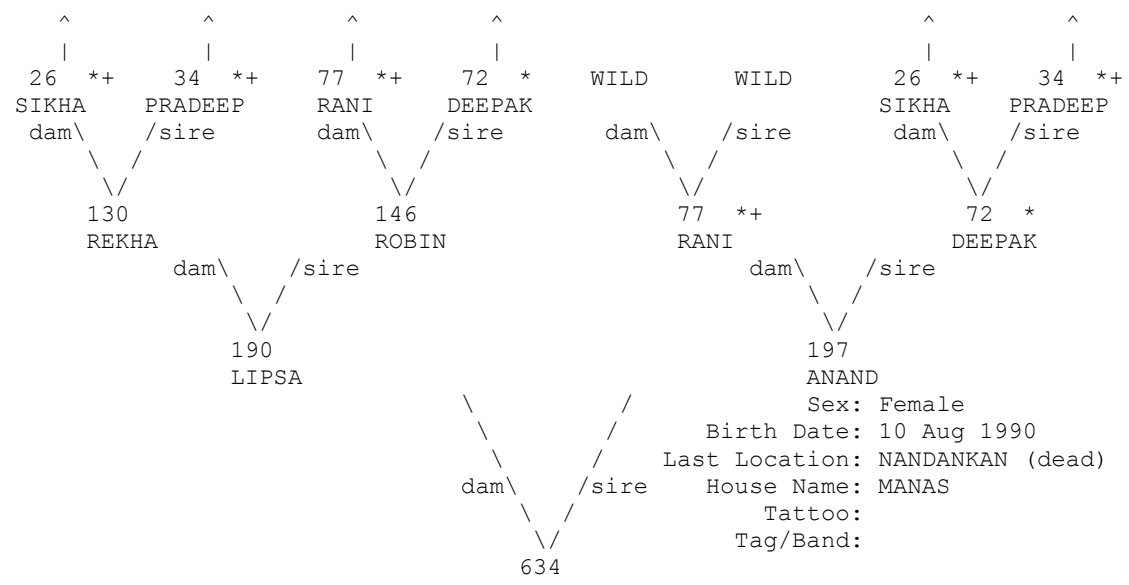

+ Wild-caught... * Appear more than once...
 ^ Pedigree continues beyond top of page...

=====
 Taxon Name: PANTHERA TIGRIS Studbook Number: 635
 =====

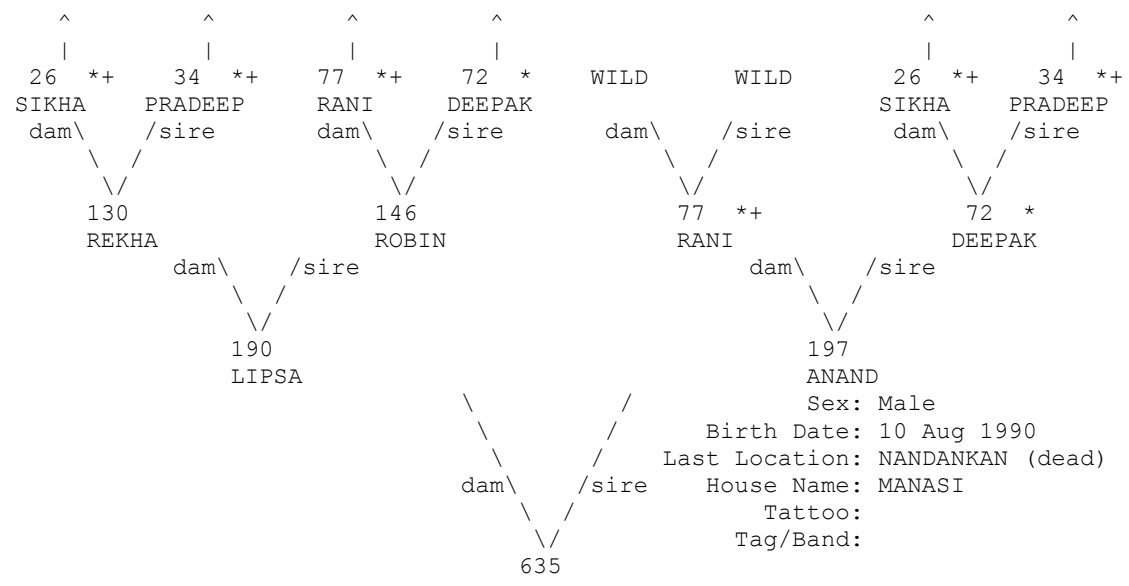

+ Wild-caught... * Appear more than once...
 ^ Pedigree continues beyond top of page...

=====
 Taxon Name: PANTHERA TIGRIS Studbook Number: 636
 =====

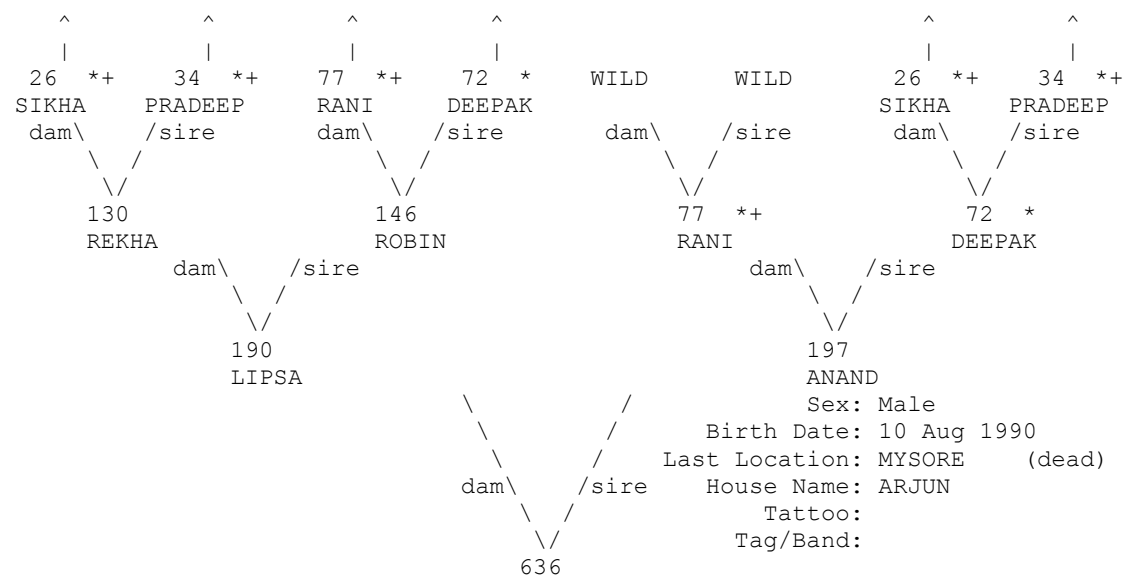

+ Wild-caught... * Appear more than once...
 ^ Pedigree continues beyond top of page...

=====
 Taxon Name: PANTHERA TIGRIS Studbook Number: 638
 =====

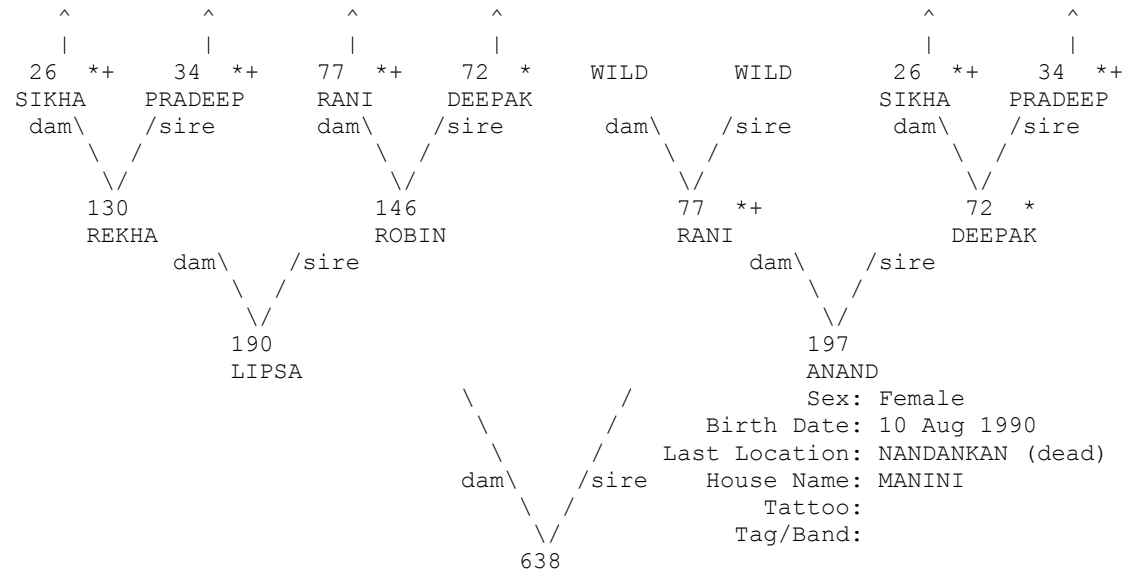

+ Wild-caught... * Appear more than once...
 ^ Pedigree continues beyond top of page...

=====
 Taxon Name: PANTHERA TIGRIS Studbook Number: 639
 =====

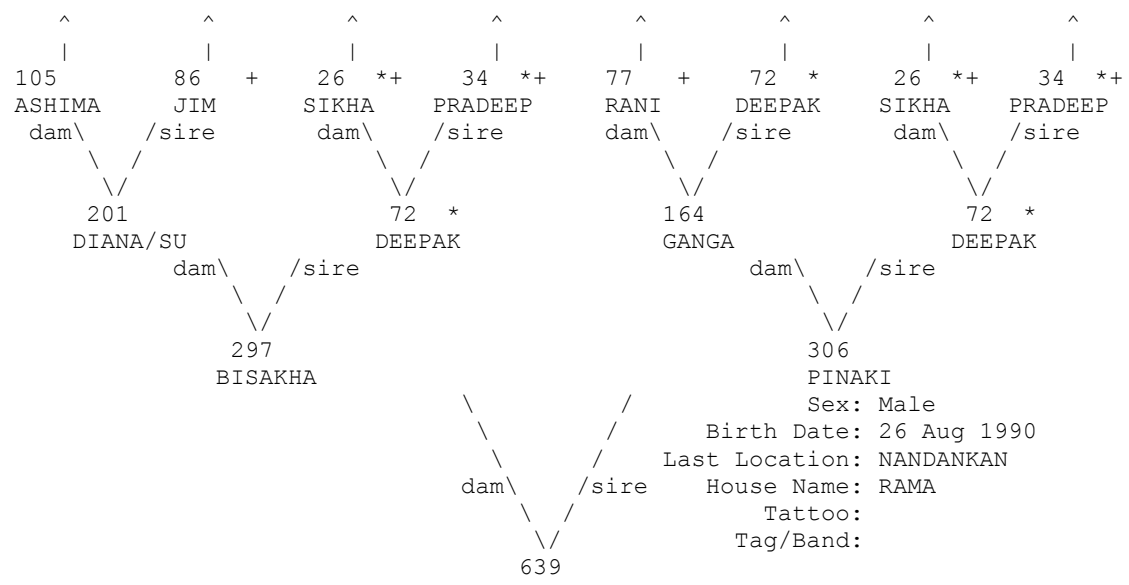

+ Wild-caught... * Appear more than once...
 ^ Pedigree continues beyond top of page...

=====
 Taxon Name: PANTHERA TIGRIS Studbook Number: 640
 =====

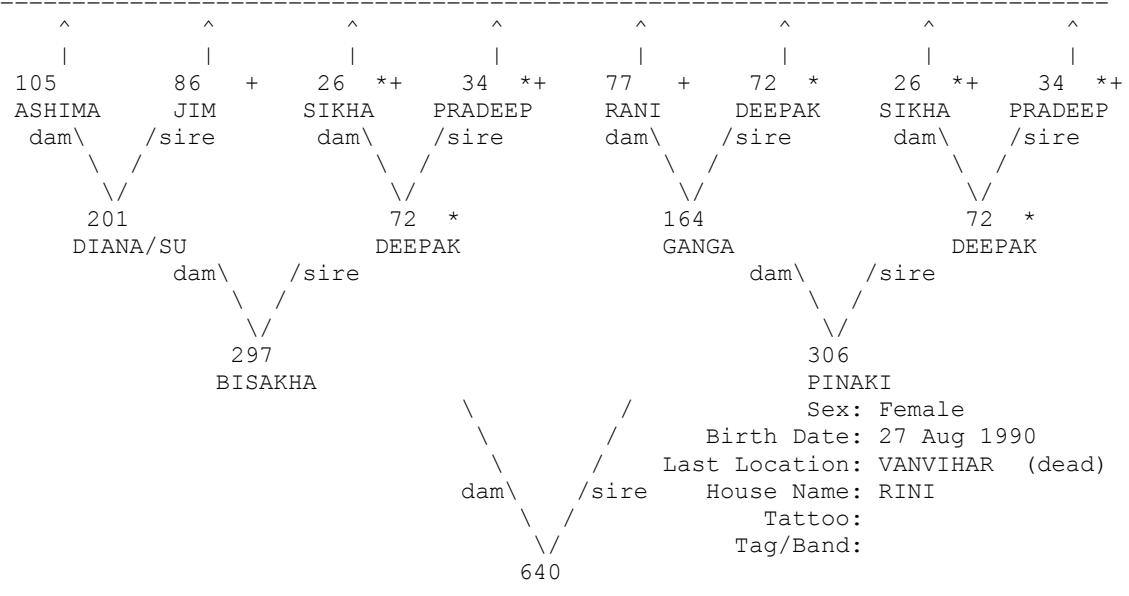

+ Wild-caught... * Appear more than once...
 ^ Pedigree continues beyond top of page...

=====
 Taxon Name: PANTHERA TIGRIS Studbook Number: 641
 =====

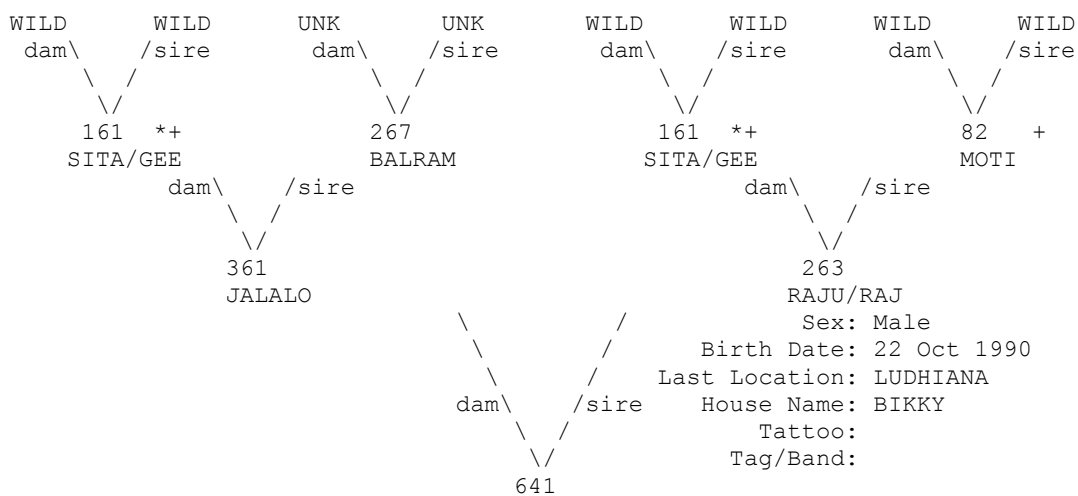

+ Wild-caught... * Appear more than once...

=====
 Taxon Name: PANTHERA TIGRIS Studbook Number: 642
 =====

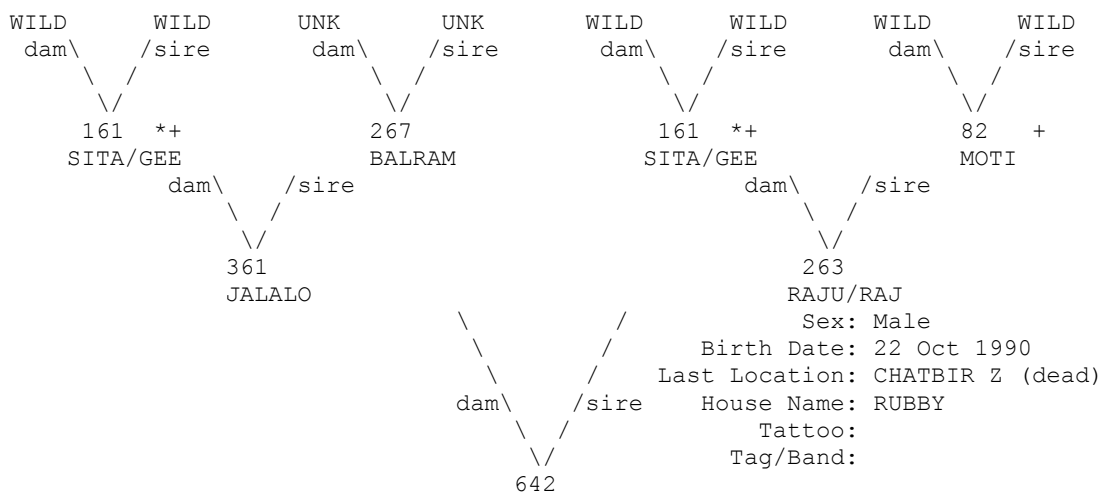

+ Wild-caught... * Appear more than once...

=====
 Taxon Name: PANTHERA TIGRIS Studbook Number: 643
 =====

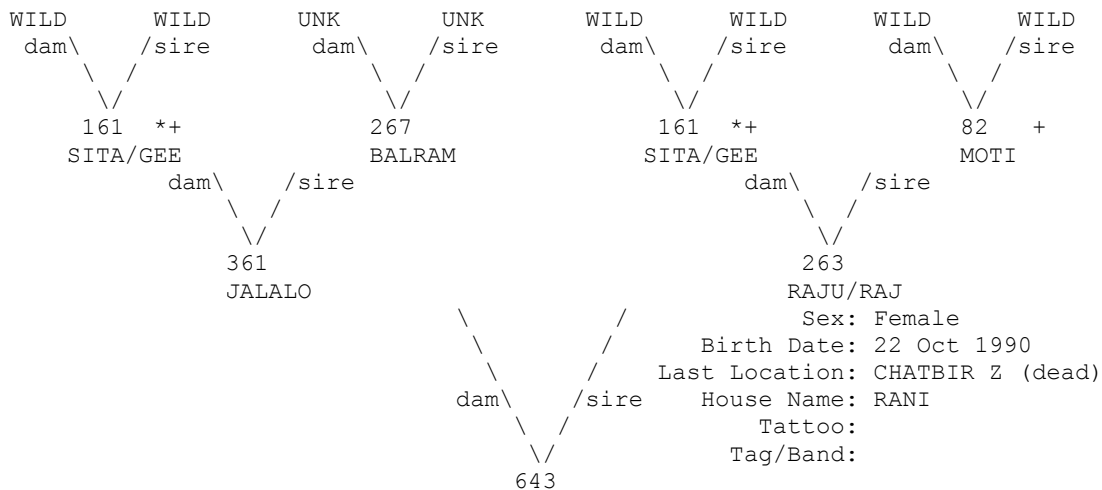

+ Wild-caught... * Appear more than once...

=====
 Taxon Name: PANTHERA TIGRIS Studbook Number: 646
 =====

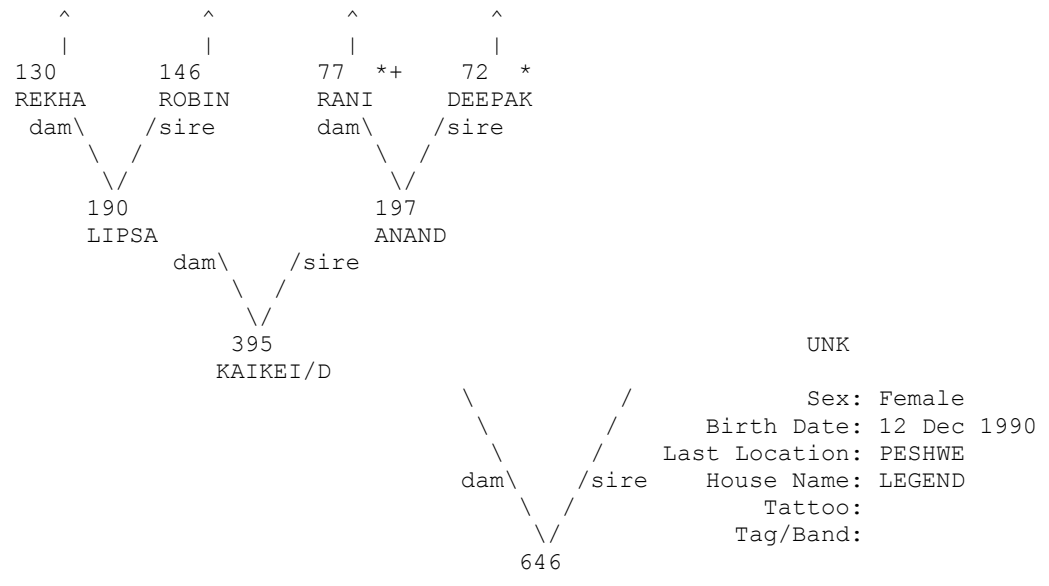

+ Wild-caught... * Appear more than once...
 ^ Pedigree continues beyond top of page...

=====
 Taxon Name: PANTHERA TIGRIS Studbook Number: 647
 =====

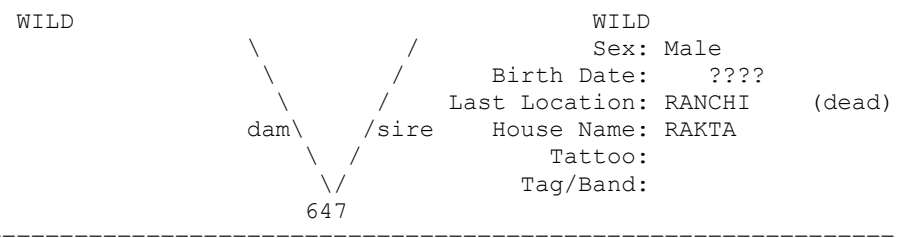

=====
 Taxon Name: PANTHERA TIGRIS Studbook Number: 648
 =====

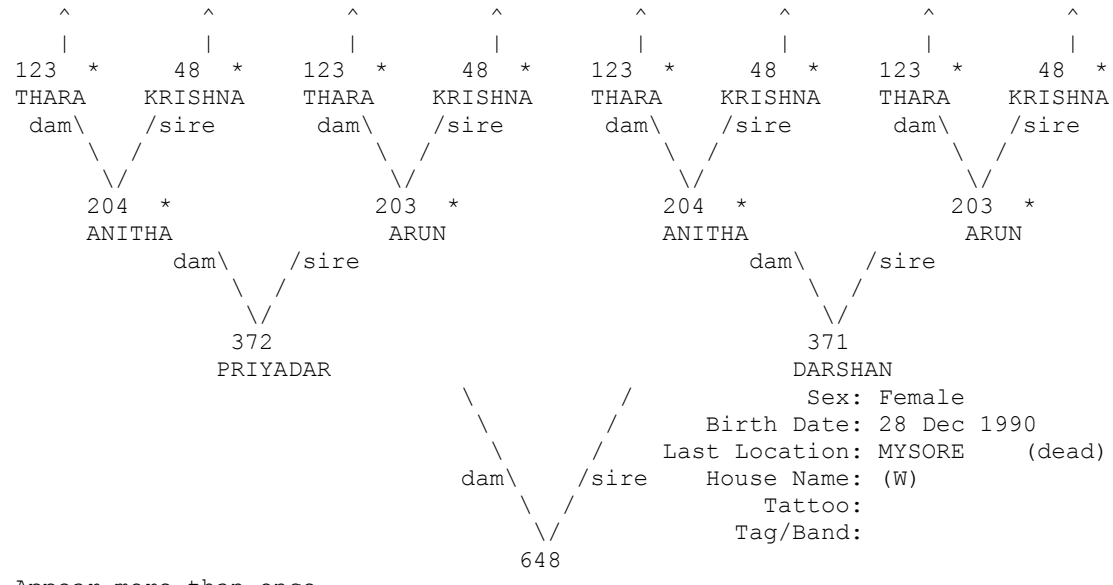

* Appear more than once...
 ^ Pedigree continues beyond top of page...

=====
 Taxon Name: PANTHERA TIGRIS Studbook Number: 649
 =====

WILD

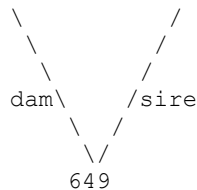

WILD
 Sex: Female
 Birth Date: ~ 1989
 Last Location: ASSAM (dead)
 House Name: RAJKUMARI II
 Tattoo:
 Tag/Band:

=====
 Taxon Name: PANTHERA TIGRIS Studbook Number: 650
 =====

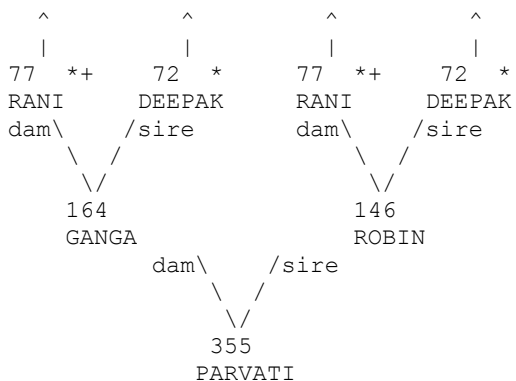

WILD WILD
 dam\ /sire
 \ /
 171 +
 SHANKAR
 Sex: Male
 Birth Date: 24 Jan 1991
 Last Location: BHILAI (dead)
 House Name: GANESH
 Tattoo:
 Tag/Band:

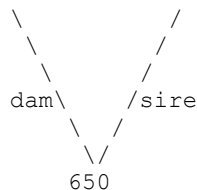

+ Wild-caught... * Appear more than once...
 ^ Pedigree continues beyond top of page...

=====
 Taxon Name: PANTHERA TIGRIS Studbook Number: 651
 =====

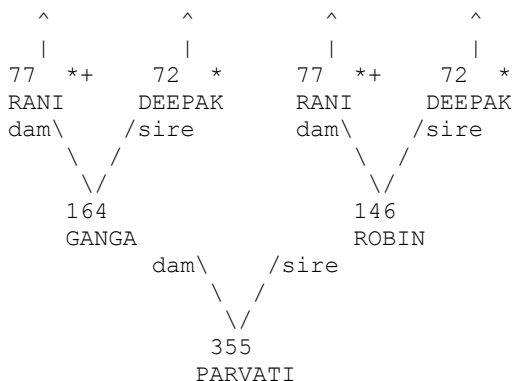

WILD WILD
 dam\ /sire
 \ /
 171 +
 SHANKAR
 Sex: Female
 Birth Date: 24 Jan 1991
 Last Location: BHILAI (dead)
 House Name: LAXMI
 Tattoo:
 Tag/Band:

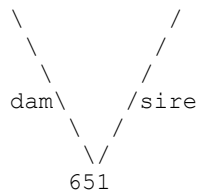

+ Wild-caught... * Appear more than once...
 ^ Pedigree continues beyond top of page...

=====
 Taxon Name: PANTHERA TIGRIS Studbook Number: 652
 =====

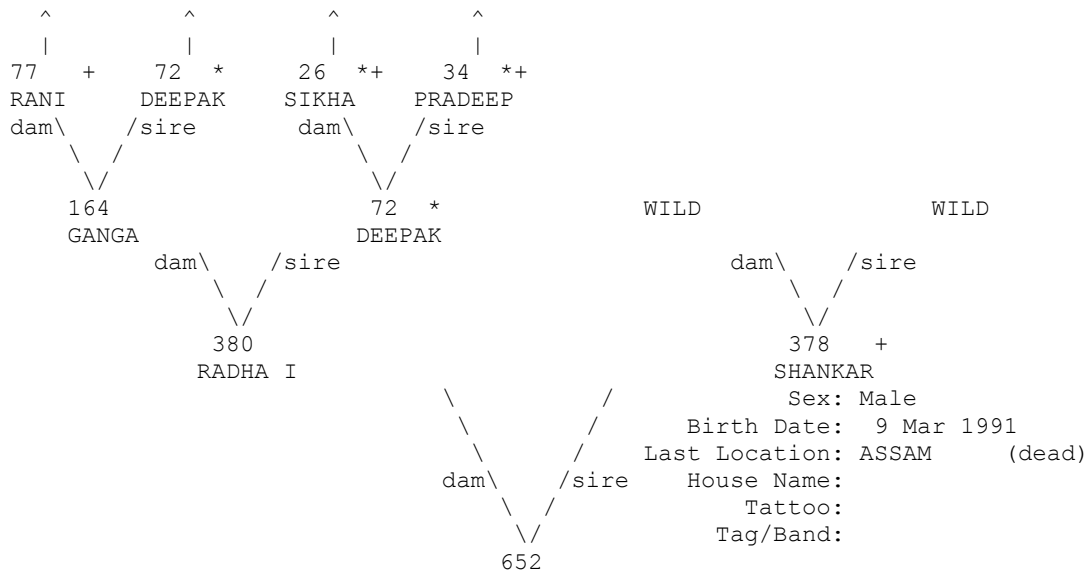

+ Wild-caught... * Appear more than once...
 ^ Pedigree continues beyond top of page...

=====
 Taxon Name: PANTHERA TIGRIS Studbook Number: 653
 =====

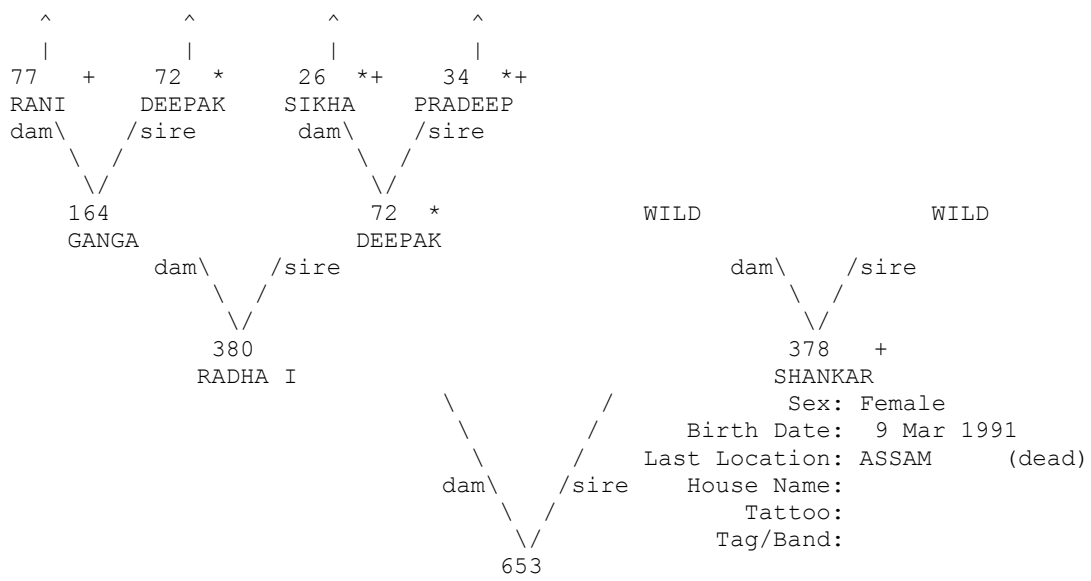

+ Wild-caught... * Appear more than once...
 ^ Pedigree continues beyond top of page...

=====
 Taxon Name: PANTHERA TIGRIS Studbook Number: 654
 =====

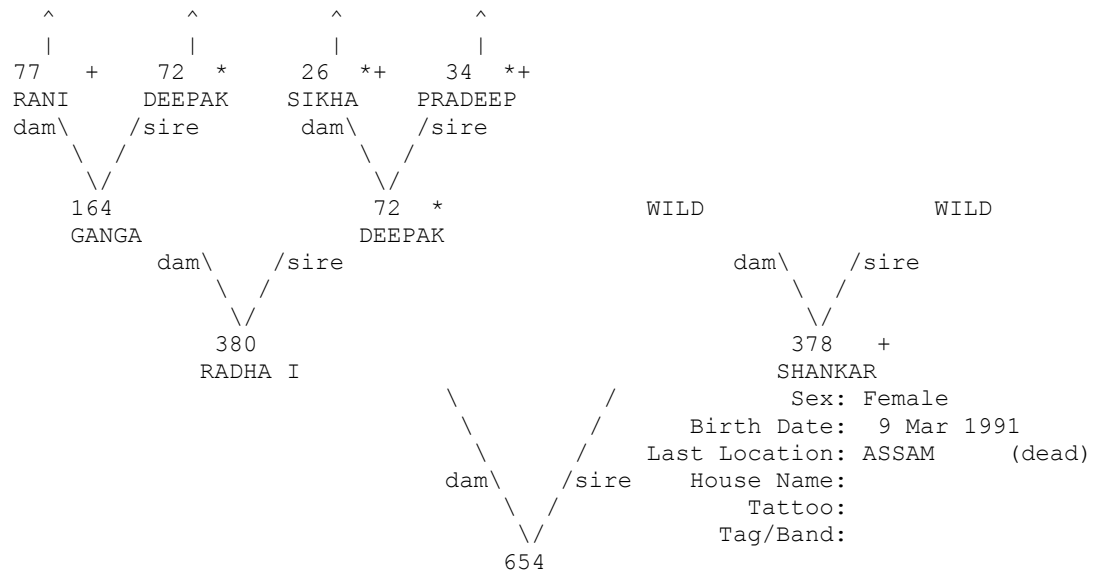

+ Wild-caught... * Appear more than once...
 ^ Pedigree continues beyond top of page...

=====
 Taxon Name: PANTHERA TIGRIS Studbook Number: 655
 =====

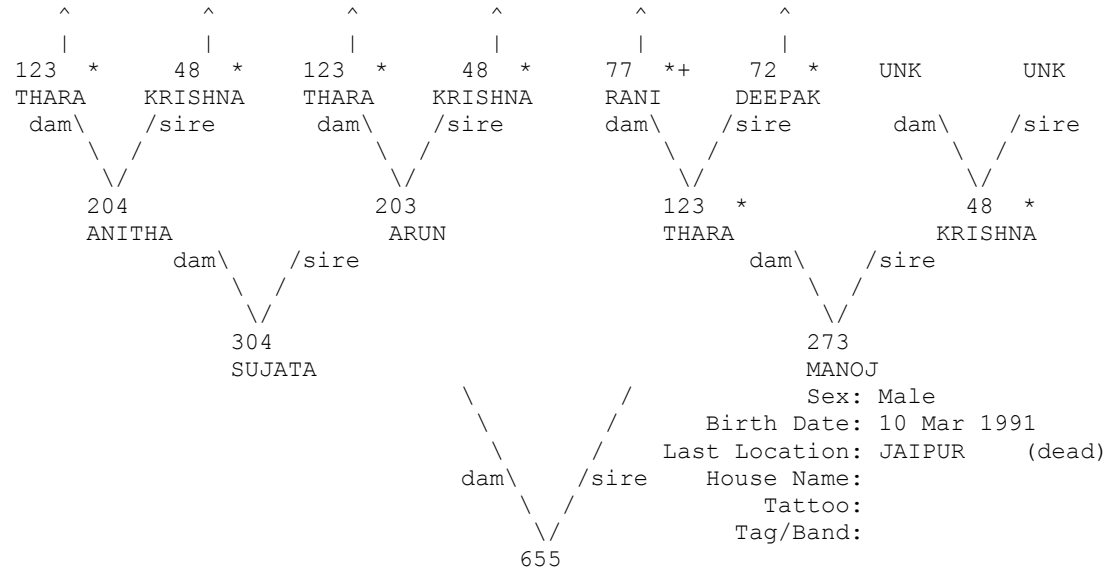

+ Wild-caught... * Appear more than once...
 ^ Pedigree continues beyond top of page...

=====
 Taxon Name: PANTHERA TIGRIS Studbook Number: 656
 =====

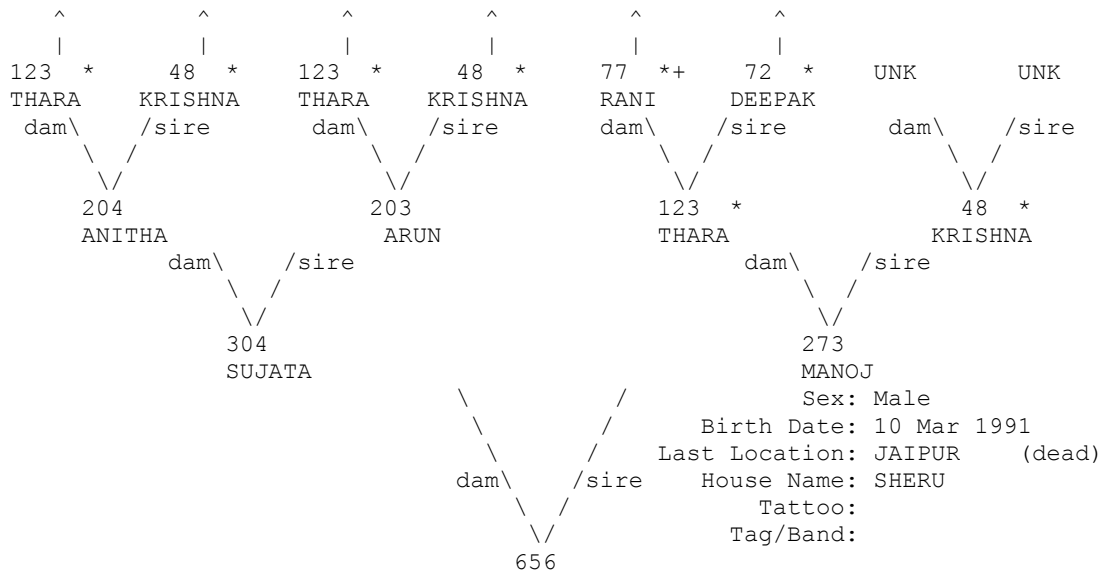

+ Wild-caught... * Appear more than once...
 ^ Pedigree continues beyond top of page...

=====
 Taxon Name: PANTHERA TIGRIS Studbook Number: 657
 =====

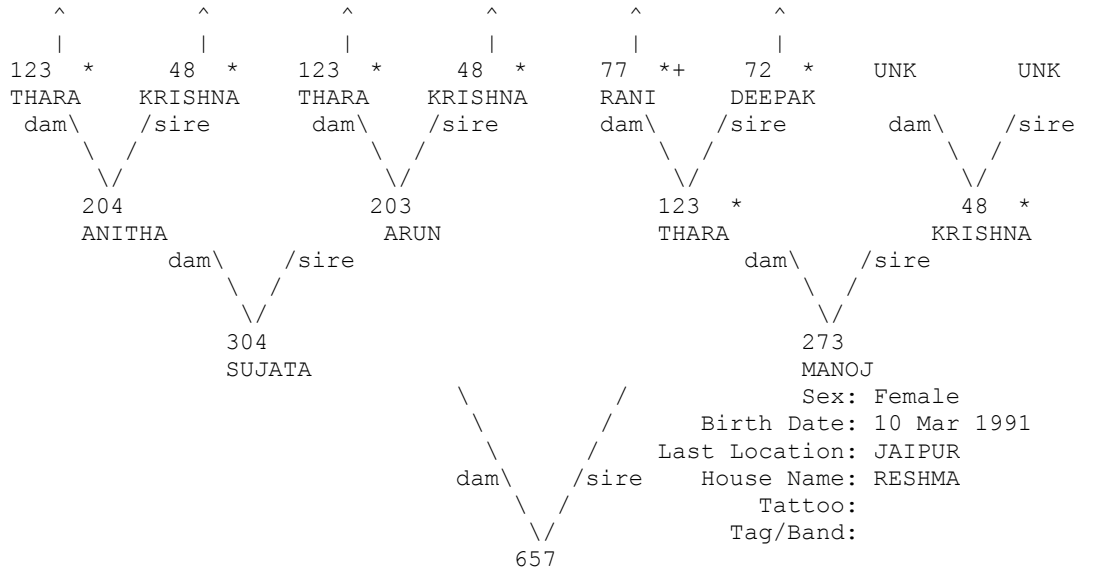

+ Wild-caught... * Appear more than once...
 ^ Pedigree continues beyond top of page...

=====
 Taxon Name: PANTHERA TIGRIS Studbook Number: 658
 =====

WILD

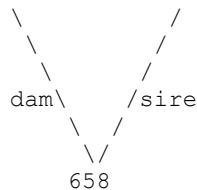

WILD
 Sex: Female
 Birth Date: ????
 Last Location: INDORE
 House Name: MAYA DEVI
 Tattoo:
 Tag/Band:

=====
 Taxon Name: PANTHERA TIGRIS Studbook Number: 659
 =====

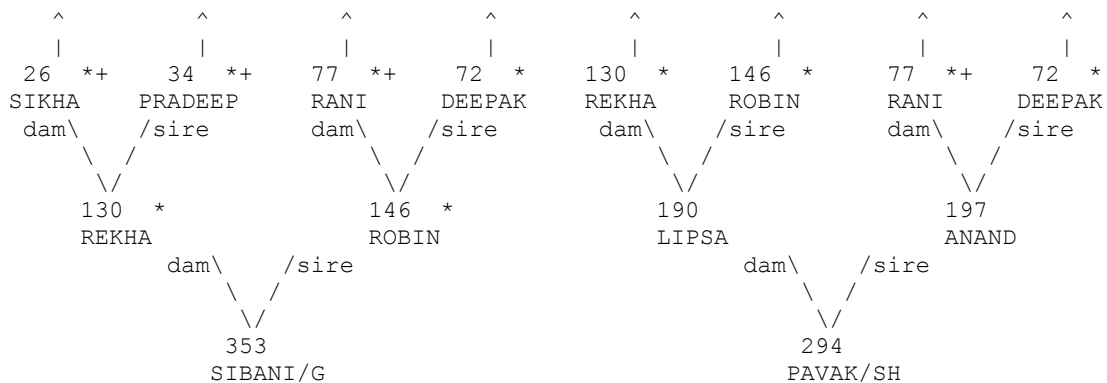

Sex: Male
 Birth Date: 6 Apr 1991
 Last Location: NAGPUR
 House Name: CHANDU
 Tattoo:
 Tag/Band:

+ Wild-caught... * Appear more than once...
 ^ Pedigree continues beyond top of page...

=====
 Taxon Name: PANTHERA TIGRIS Studbook Number: 660
 =====

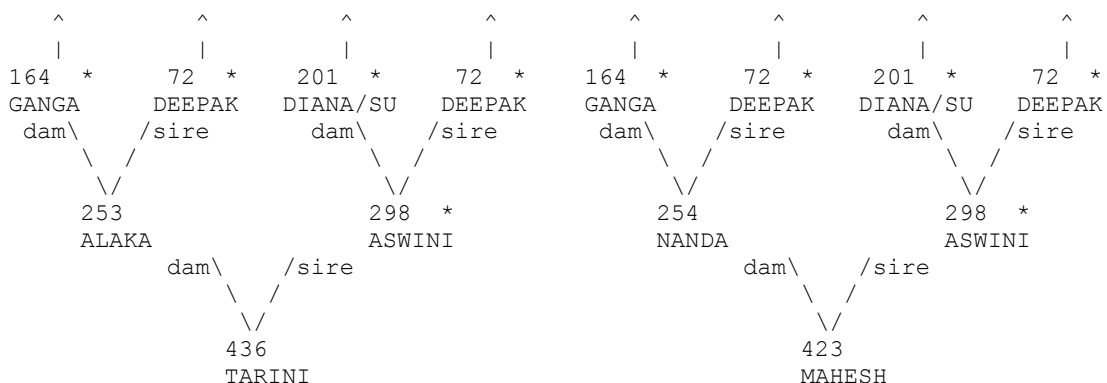

Sex: Female
 Birth Date: 10 Apr 1991
 Last Location: NANDANKAN (dead)
 House Name:
 Tattoo:
 Tag/Band:

* Appear more than once...
 ^ Pedigree continues beyond top of page...

=====
 Taxon Name: PANTHERA TIGRIS Studbook Number: 661
 =====

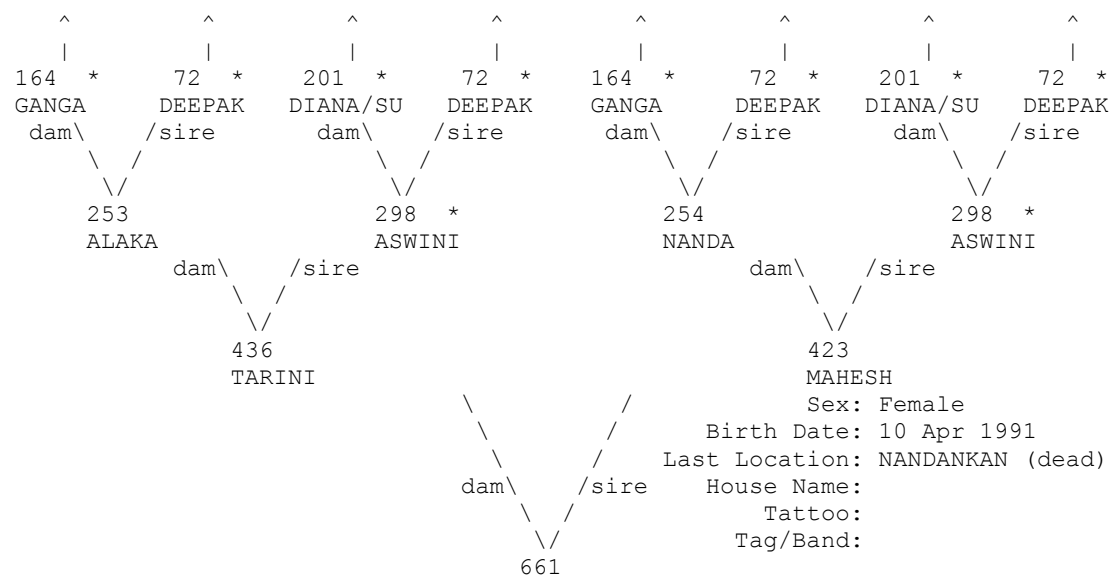

* Appear more than once...
 ^ Pedigree continues beyond top of page...

=====
 Taxon Name: PANTHERA TIGRIS Studbook Number: 662
 =====

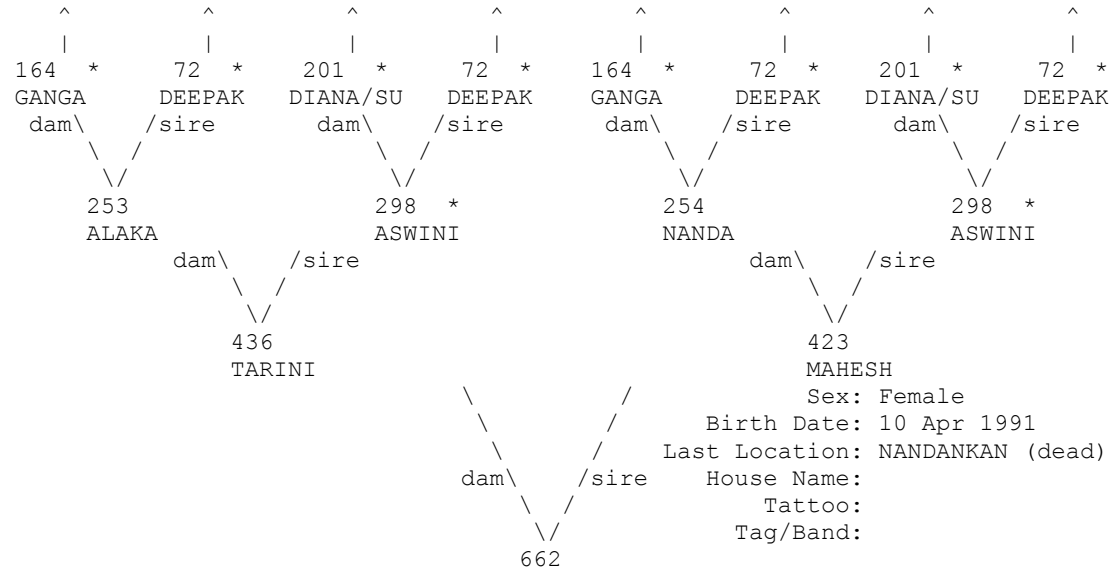

* Appear more than once...
 ^ Pedigree continues beyond top of page...

=====
 Taxon Name: PANTHERA TIGRIS Studbook Number: 663
 =====

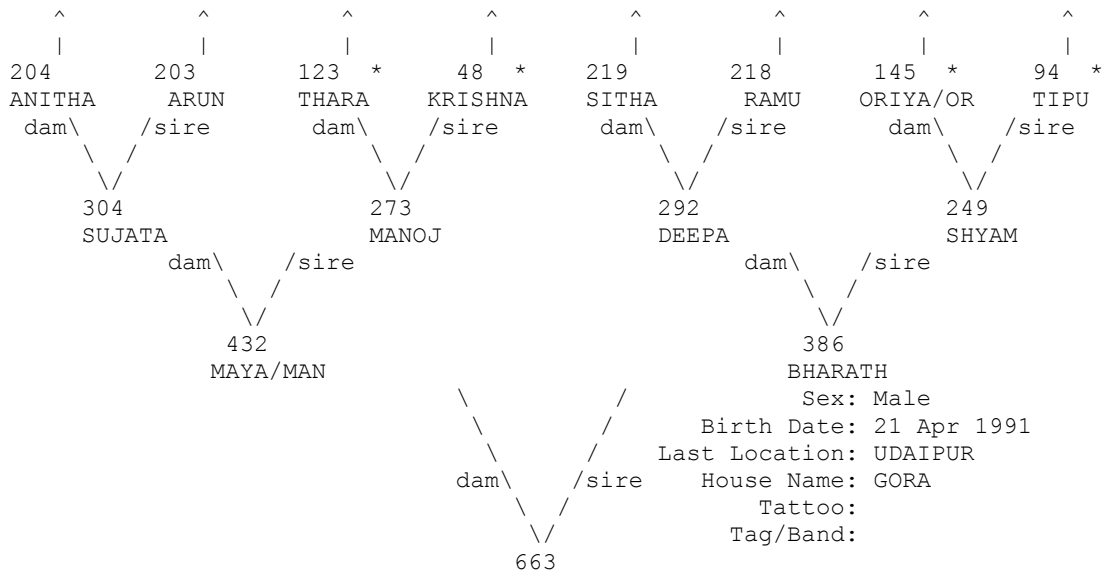

* Appear more than once...
 ^ Pedigree continues beyond top of page...

=====
 Taxon Name: PANTHERA TIGRIS Studbook Number: 664
 =====

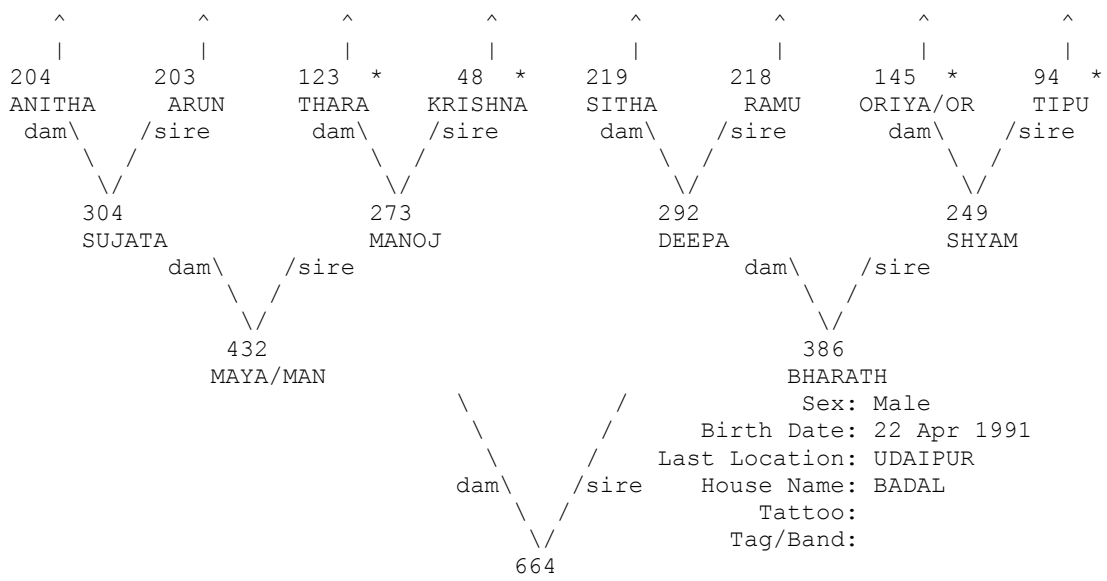

* Appear more than once...
 ^ Pedigree continues beyond top of page...

=====
 Taxon Name: PANTHERA TIGRIS Studbook Number: 665
 =====

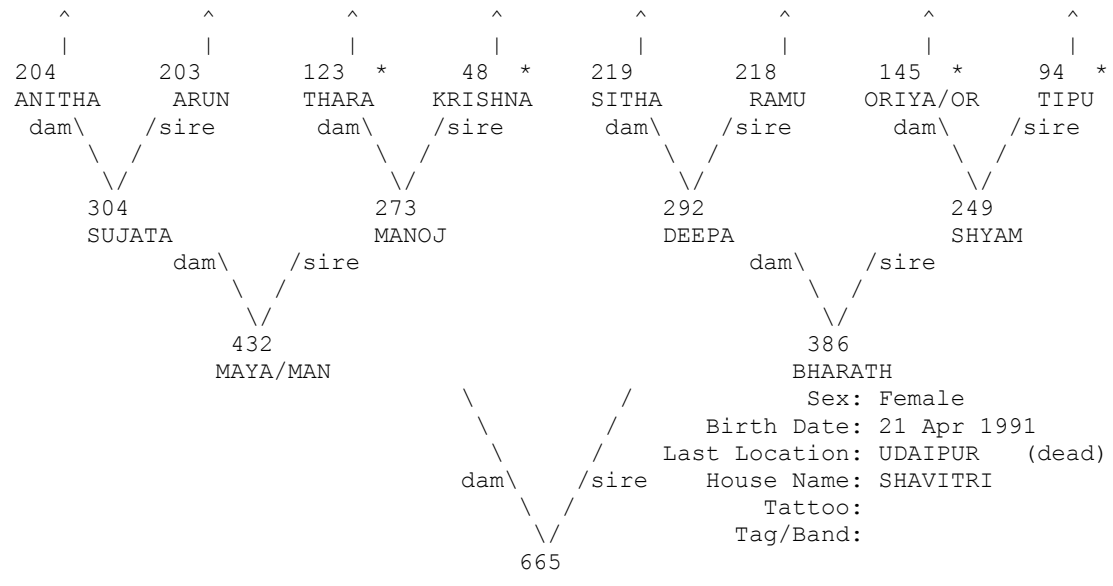

* Appear more than once...
 ^ Pedigree continues beyond top of page...

=====
 Taxon Name: PANTHERA TIGRIS Studbook Number: 666
 =====

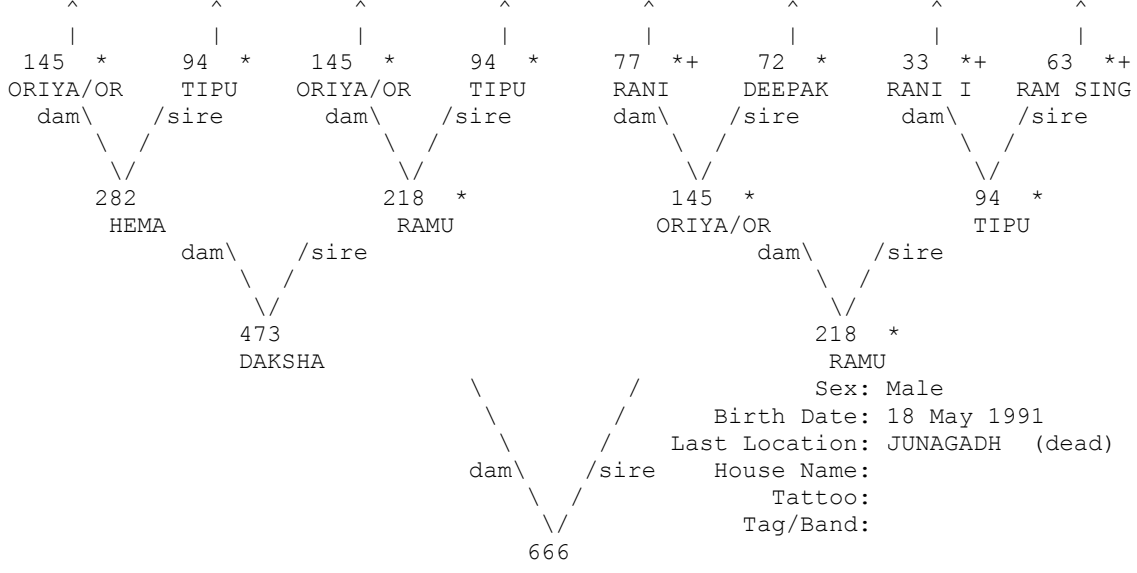

+ Wild-caught... * Appear more than once...
 ^ Pedigree continues beyond top of page...

^ Pedigree continues beyond top of page...

=====
Taxon Name: PANTHERA TIGRIS Studbook Number: 672
=====

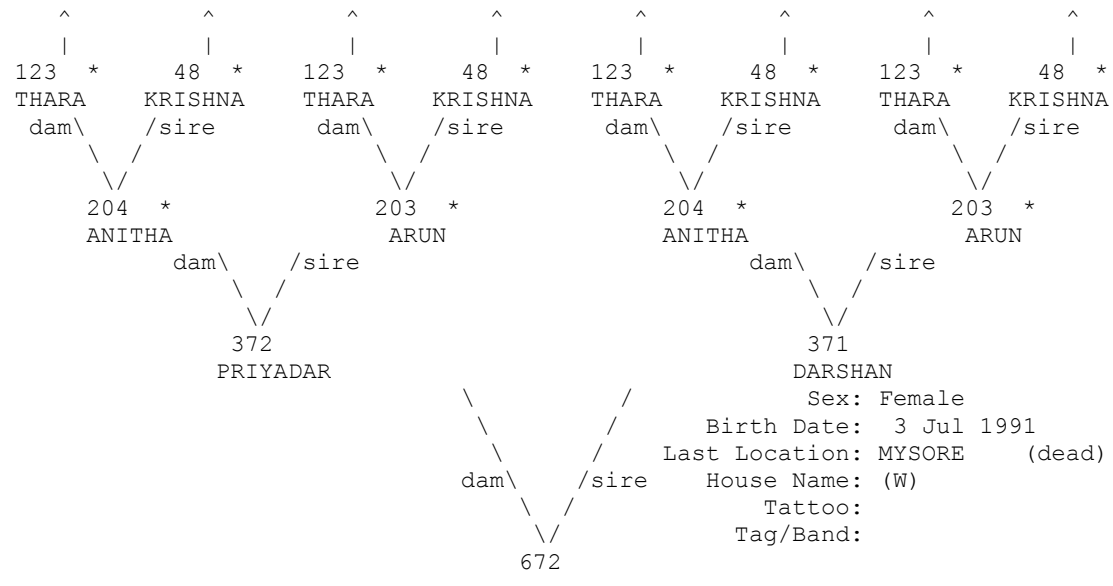

=====
 Taxon Name: PANTHERA TIGRIS Studbook Number: 674
 =====

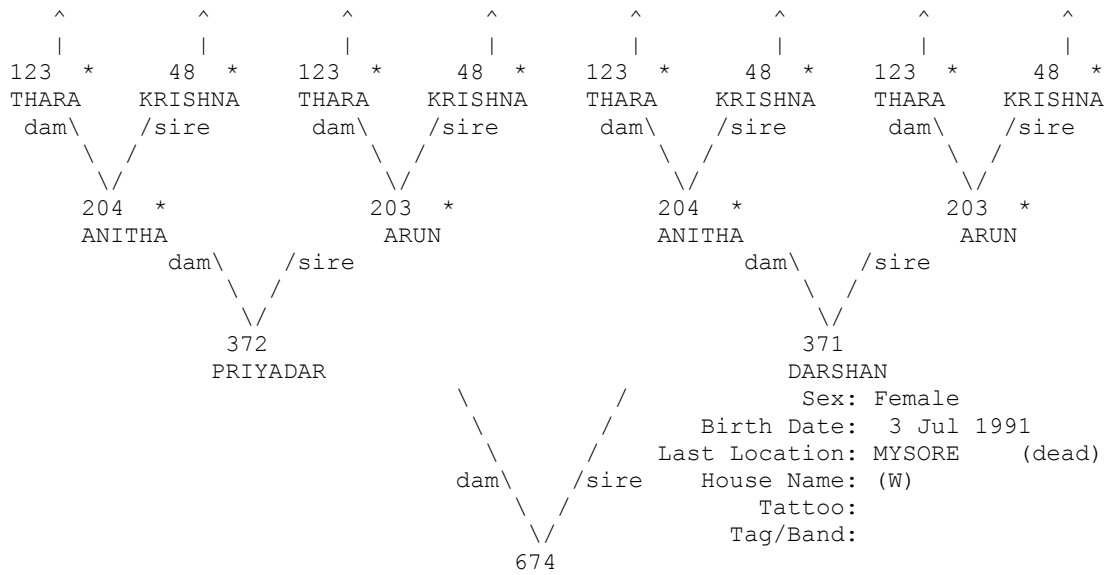

* Appear more than once...
 ^ Pedigree continues beyond top of page...

=====
 Taxon Name: PANTHERA TIGRIS Studbook Number: 675
 =====

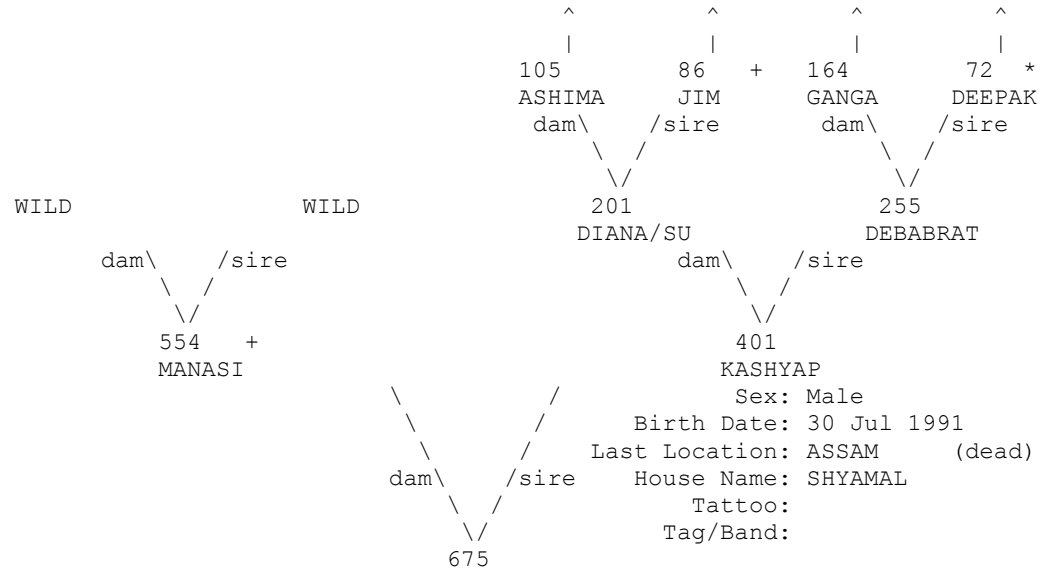

+ Wild-caught... * Appear more than once...
 ^ Pedigree continues beyond top of page...

=====
 Taxon Name: PANTHERA TIGRIS Studbook Number: 676
 =====

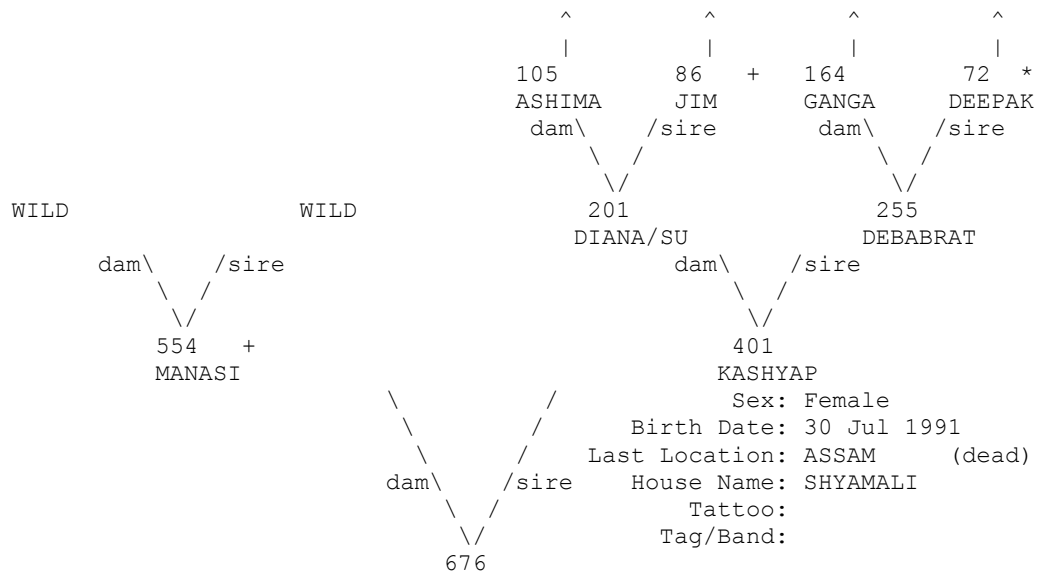

+ Wild-caught... * Appear more than once...
 ^ Pedigree continues beyond top of page...

=====
 Taxon Name: PANTHERA TIGRIS Studbook Number: 677
 =====

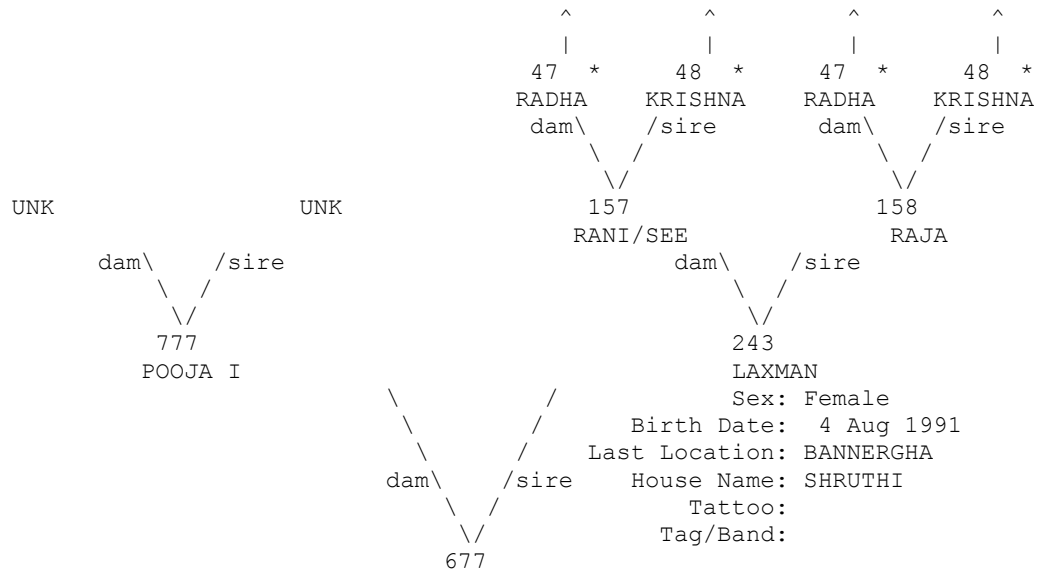

* Appear more than once...
 ^ Pedigree continues beyond top of page...

=====
 Taxon Name: PANTHERA TIGRIS Studbook Number: 678
 =====

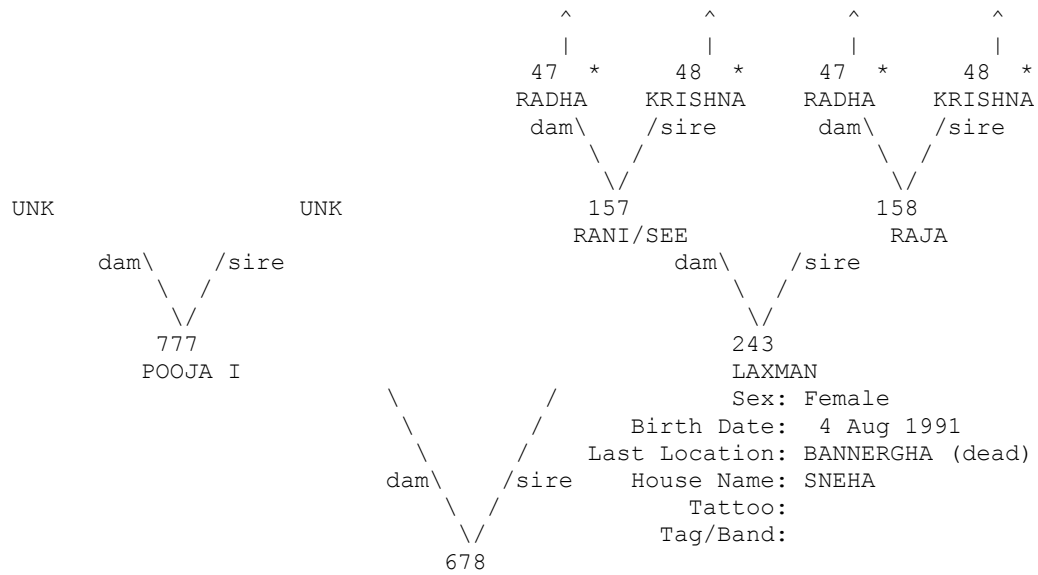

* Appear more than once...
 ^ Pedigree continues beyond top of page...

=====
 Taxon Name: PANTHERA TIGRIS Studbook Number: 679
 =====

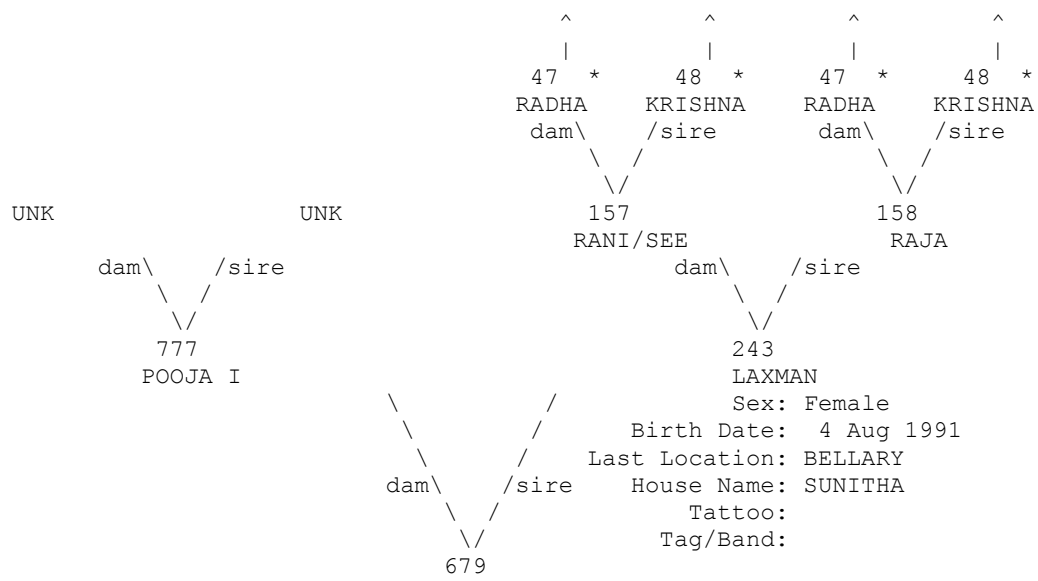

* Appear more than once...
 ^ Pedigree continues beyond top of page...

=====
 Taxon Name: PANTHERA TIGRIS Studbook Number: 682
 =====

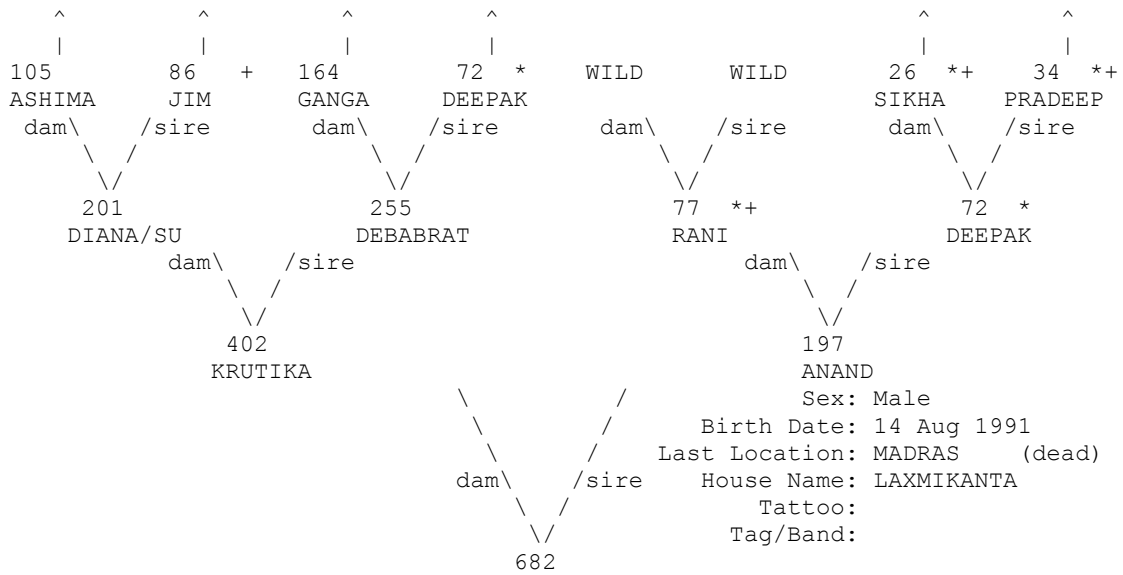

+ Wild-caught... * Appear more than once...
 ^ Pedigree continues beyond top of page...

=====
 Taxon Name: PANTHERA TIGRIS Studbook Number: 683
 =====

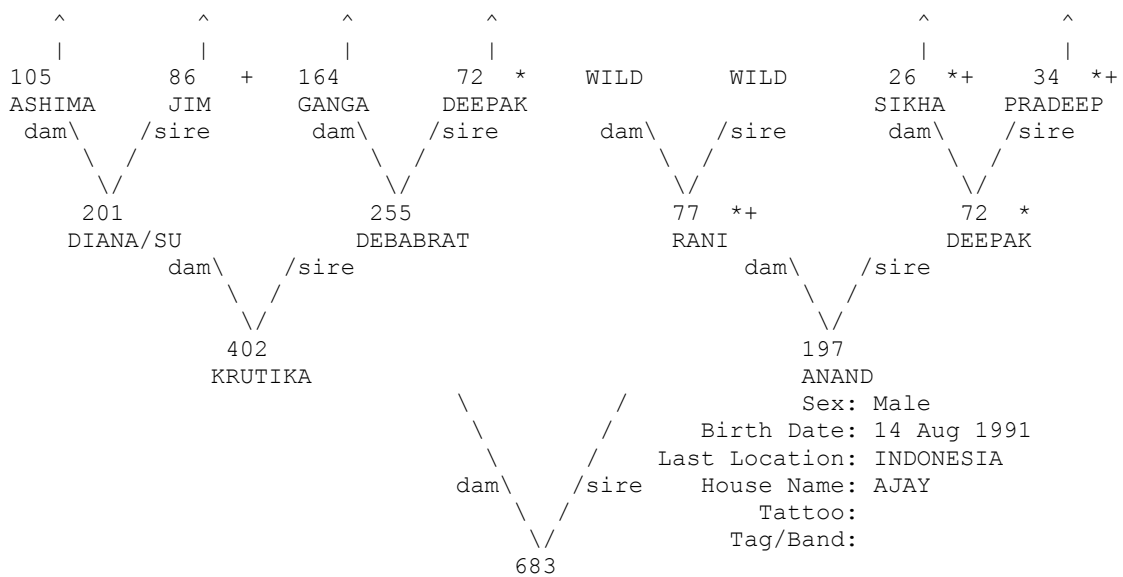

+ Wild-caught... * Appear more than once...
 ^ Pedigree continues beyond top of page...

=====
 Taxon Name: PANTHERA TIGRIS Studbook Number: 684
 =====

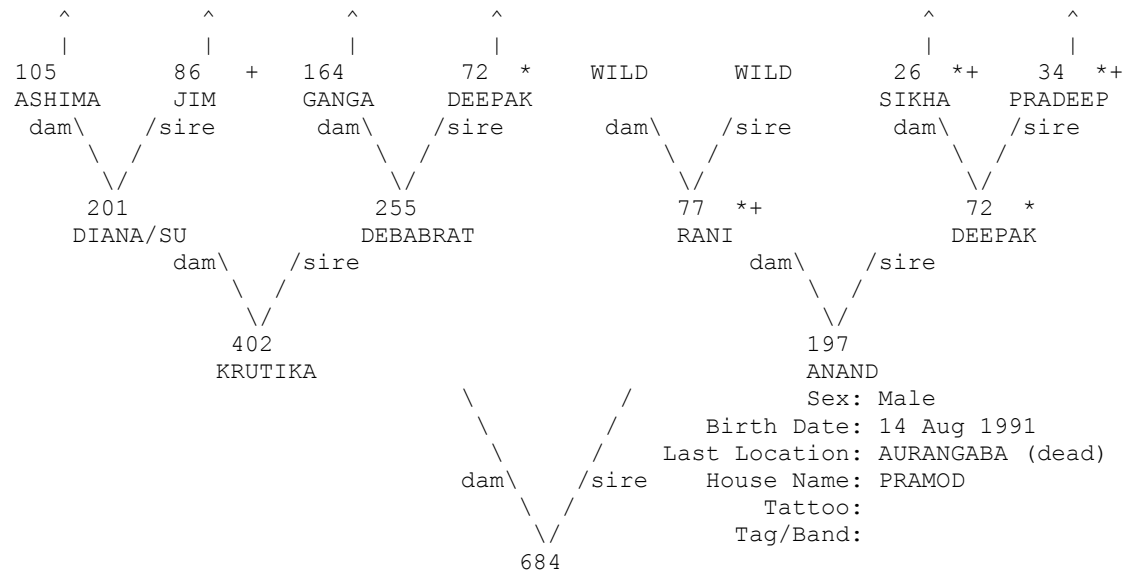

Sex: Male
 Birth Date: 14 Aug 1991
 Last Location: AURANGABA (dead)
 House Name: PRAMOD
 Tattoo:
 Tag/Band:

+ Wild-caught... * Appear more than once...
 ^ Pedigree continues beyond top of page...

=====
 Taxon Name: PANTHERA TIGRIS Studbook Number: 685
 =====

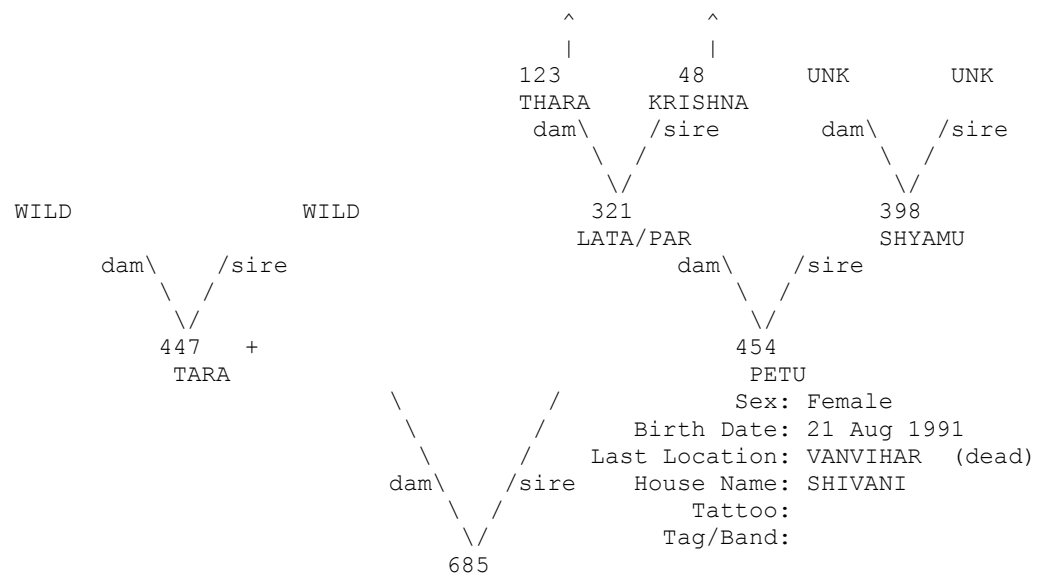

Sex: Female
 Birth Date: 21 Aug 1991
 Last Location: VANVIHAR (dead)
 House Name: SHIVANI
 Tattoo:
 Tag/Band:

+ Wild-caught...
 ^ Pedigree continues beyond top of page...

=====
 Taxon Name: PANTHERA TIGRIS Studbook Number: 688
 =====

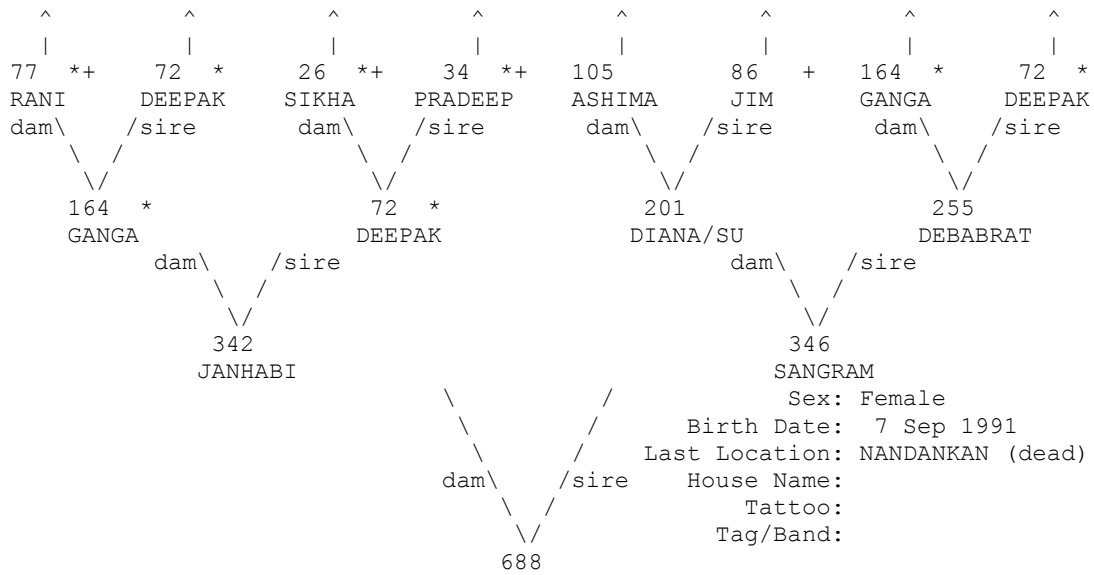

+ Wild-caught... * Appear more than once...
 ^ Pedigree continues beyond top of page...

=====
 Taxon Name: PANTHERA TIGRIS Studbook Number: 689
 =====

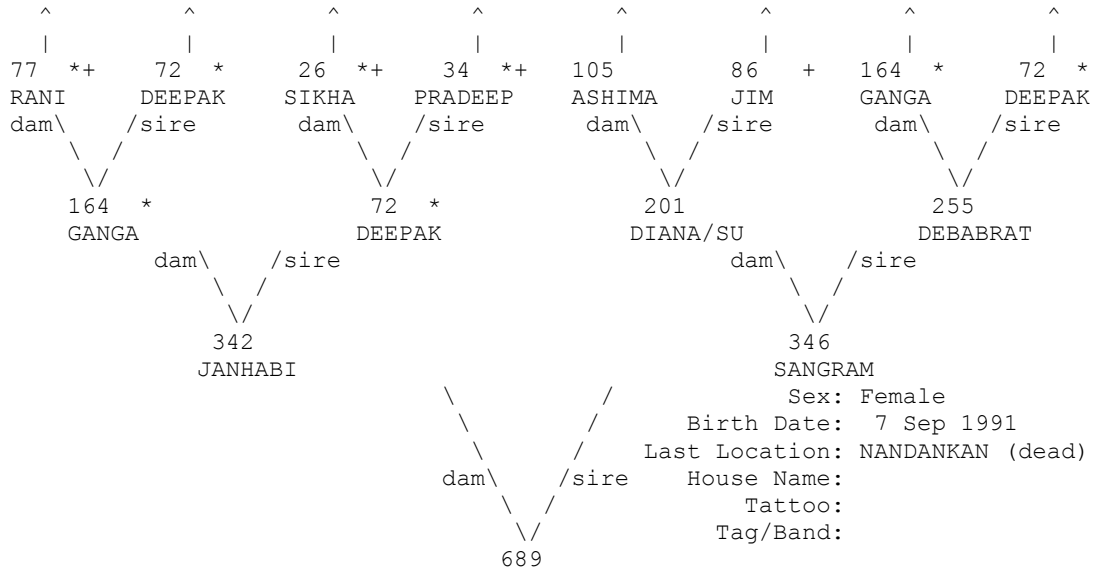

+ Wild-caught... * Appear more than once...
 ^ Pedigree continues beyond top of page...

=====
 Taxon Name: PANTHERA TIGRIS Studbook Number: 690
 =====

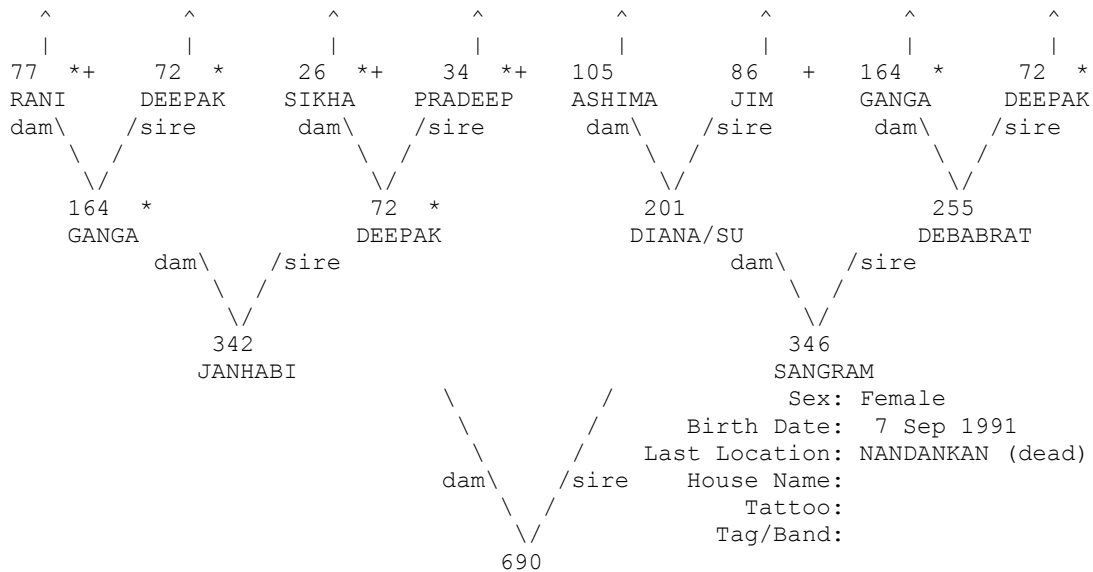

+ Wild-caught... * Appear more than once...
 ^ Pedigree continues beyond top of page...

=====
 Taxon Name: PANTHERA TIGRIS Studbook Number: 691
 =====

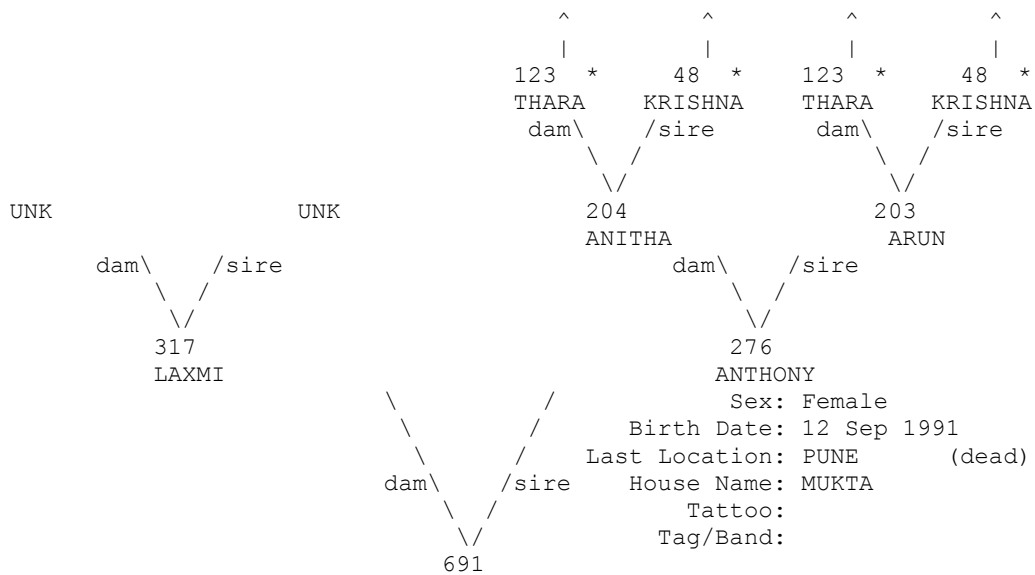

* Appear more than once...
 ^ Pedigree continues beyond top of page...

=====
 Taxon Name: PANTHERA TIGRIS Studbook Number: 692
 =====

UNK

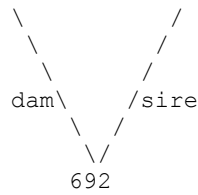

UNK
 Sex: Female
 Birth Date: 26 Oct 1991
 Last Location: UNKNOWN
 House Name: SHANTI
 Tattoo:
 Tag/Band:

=====
 Taxon Name: PANTHERA TIGRIS Studbook Number: 693
 =====

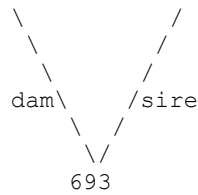
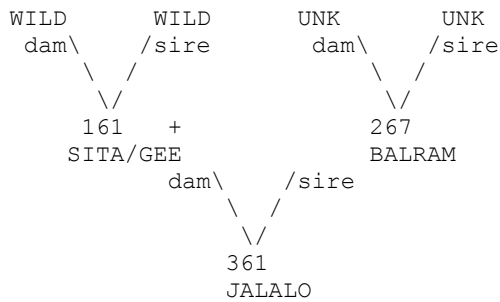

UNK
 Sex: Female
 Birth Date: 26 Oct 1991
 Last Location: LUDHIANA
 House Name: SITA
 Tattoo:
 Tag/Band:

+ Wild-caught...

=====
 Taxon Name: PANTHERA TIGRIS Studbook Number: 694
 =====

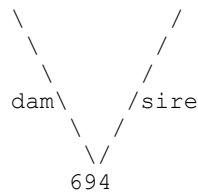
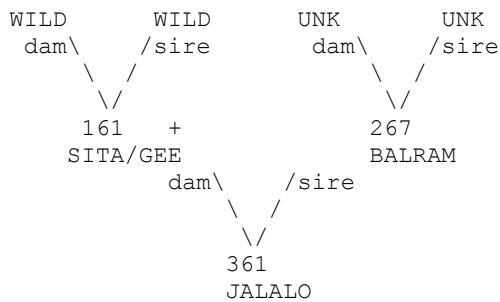

UNK
 Sex: Male
 Birth Date: 26 Oct 1991
 Last Location: LUDHIANA
 House Name: BAGGA
 Tattoo:
 Tag/Band:

+ Wild-caught...

```

=====
Taxon Name: PANTHERA TIGRIS                               Studbook Number: 695
=====

```

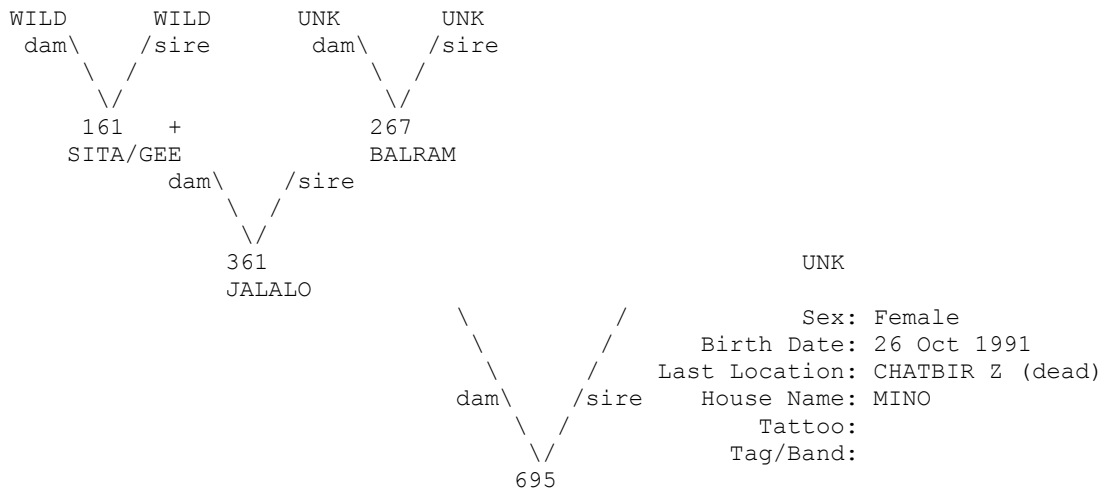

+ Wild-caught...

```

=====
Taxon Name: PANTHERA TIGRIS                               Studbook Number: 696
=====

```

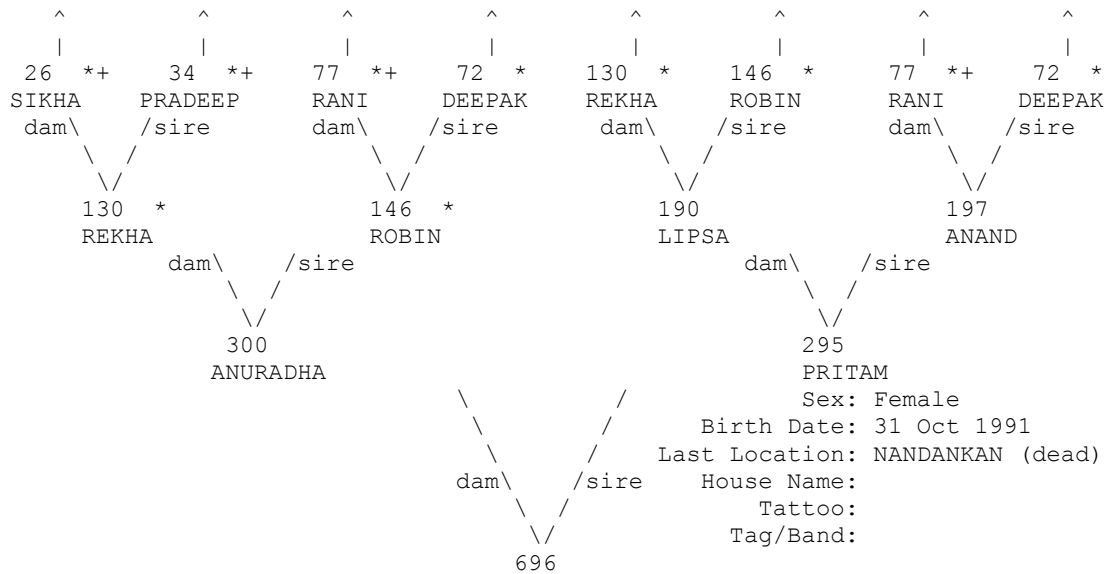

+ Wild-caught... * Appear more than once...

^ Pedigree continues beyond top of page...

=====
 Taxon Name: PANTHERA TIGRIS Studbook Number: 697
 =====

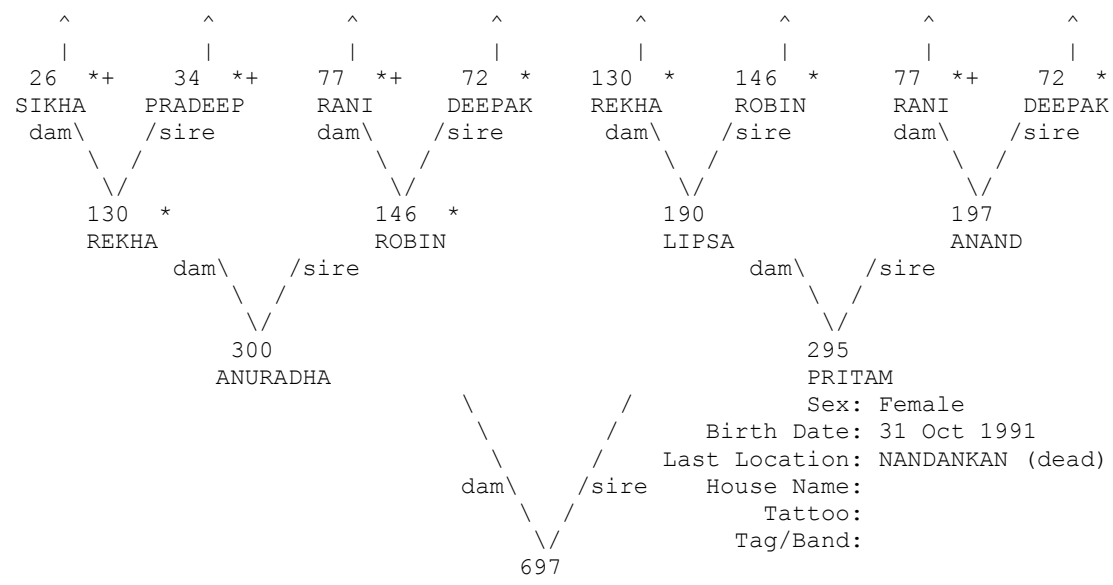

+ Wild-caught... * Appear more than once...
 ^ Pedigree continues beyond top of page...

=====
 Taxon Name: PANTHERA TIGRIS Studbook Number: 698
 =====

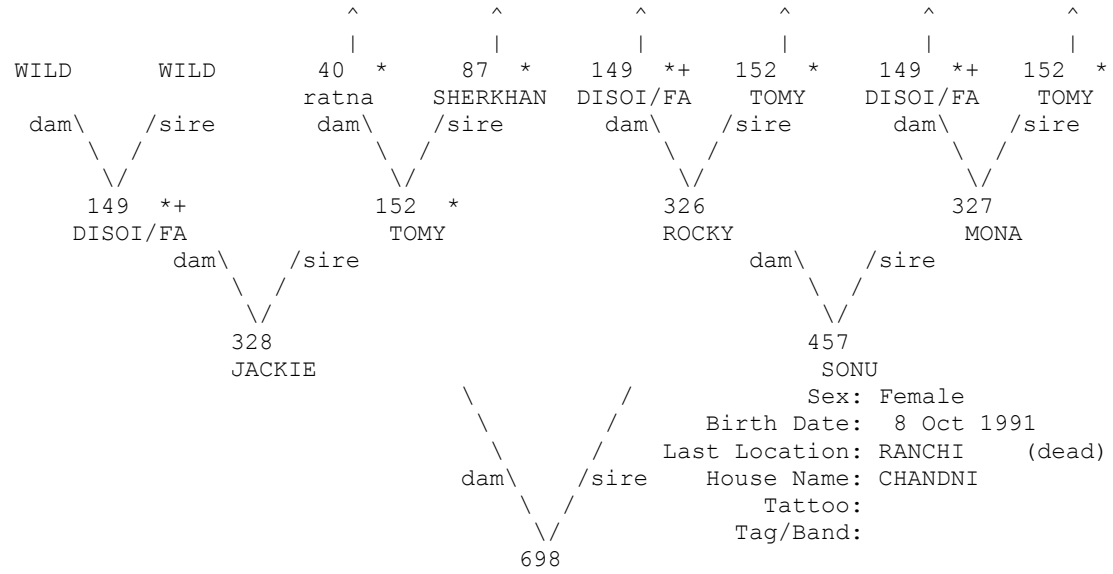

+ Wild-caught... * Appear more than once...
 ^ Pedigree continues beyond top of page...

=====
 Taxon Name: PANTHERA TIGRIS Studbook Number: 699
 =====

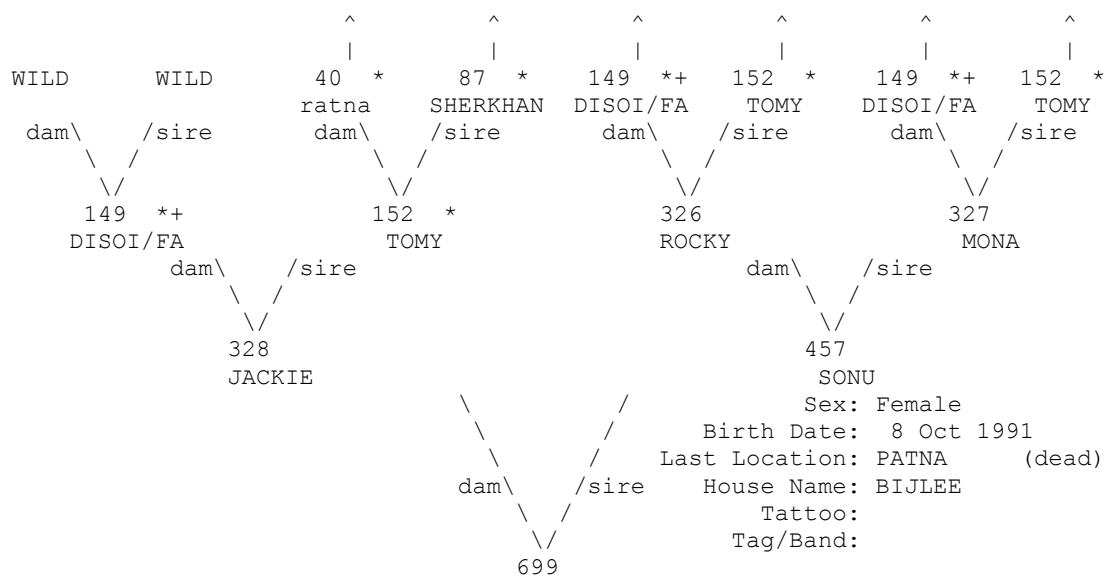

+ Wild-caught... * Appear more than once...
 ^ Pedigree continues beyond top of page...

=====
 Taxon Name: PANTHERA TIGRIS Studbook Number: 700
 =====

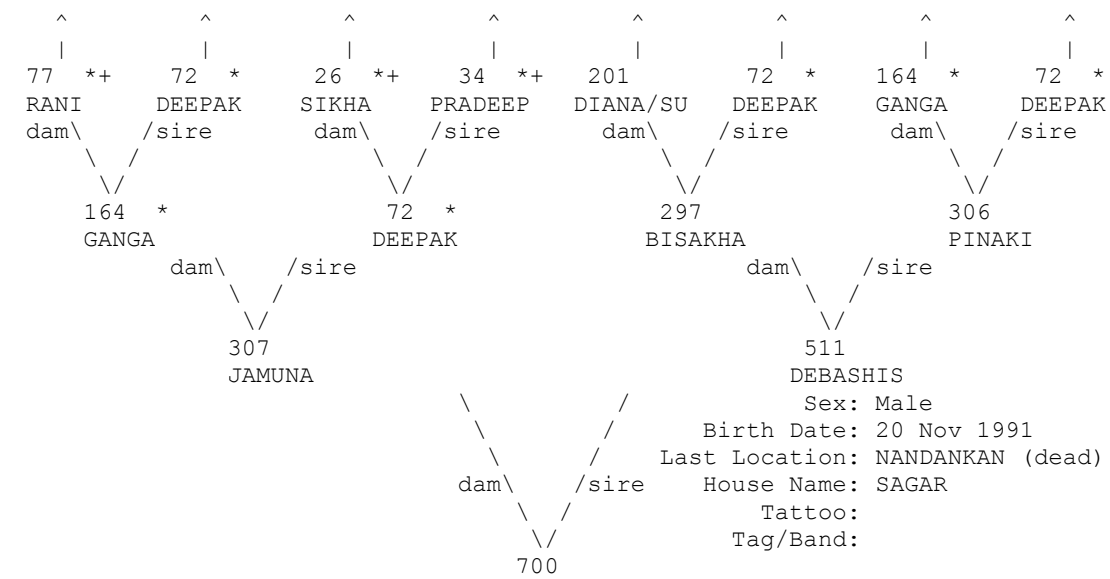

+ Wild-caught... * Appear more than once...
 ^ Pedigree continues beyond top of page...

=====
 Taxon Name: PANTHERA TIGRIS Studbook Number: 701
 =====

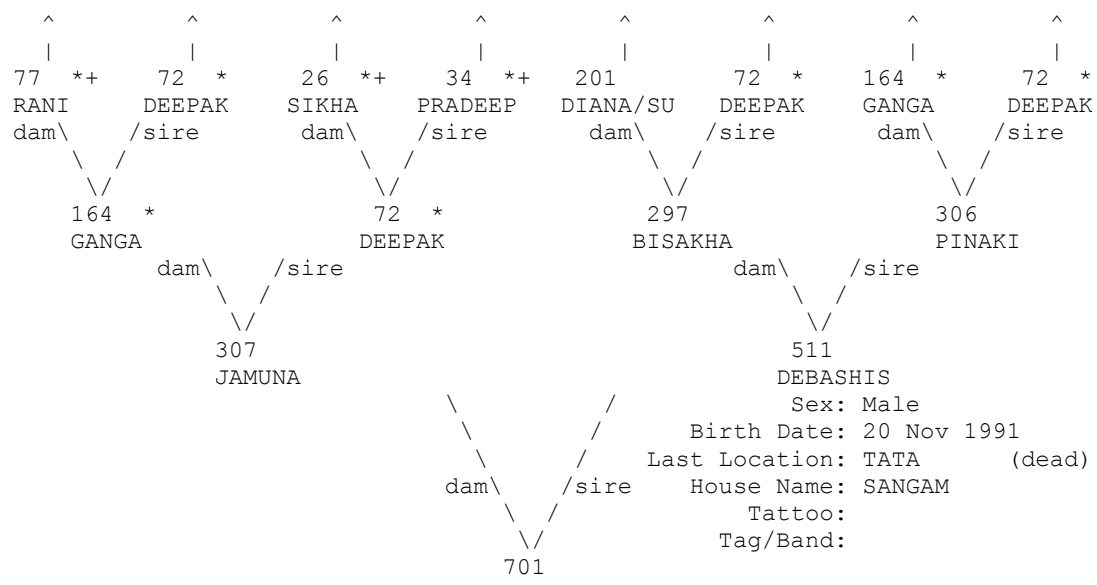

+ Wild-caught... * Appear more than once...
 ^ Pedigree continues beyond top of page...

=====
 Taxon Name: PANTHERA TIGRIS Studbook Number: 702
 =====

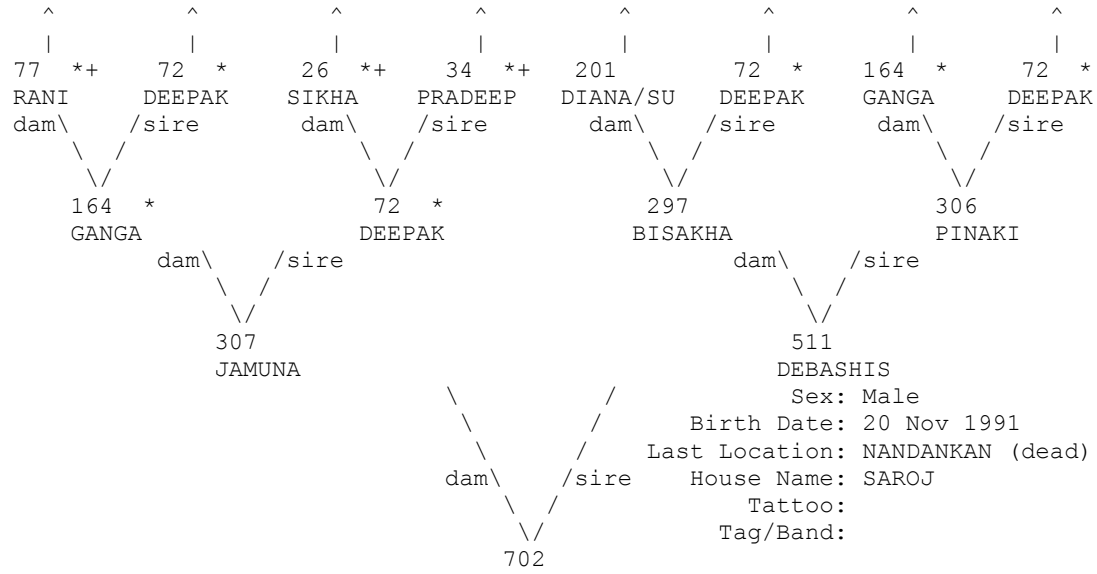

+ Wild-caught... * Appear more than once...
 ^ Pedigree continues beyond top of page...

=====
 Taxon Name: PANTHERA TIGRIS Studbook Number: 703
 =====

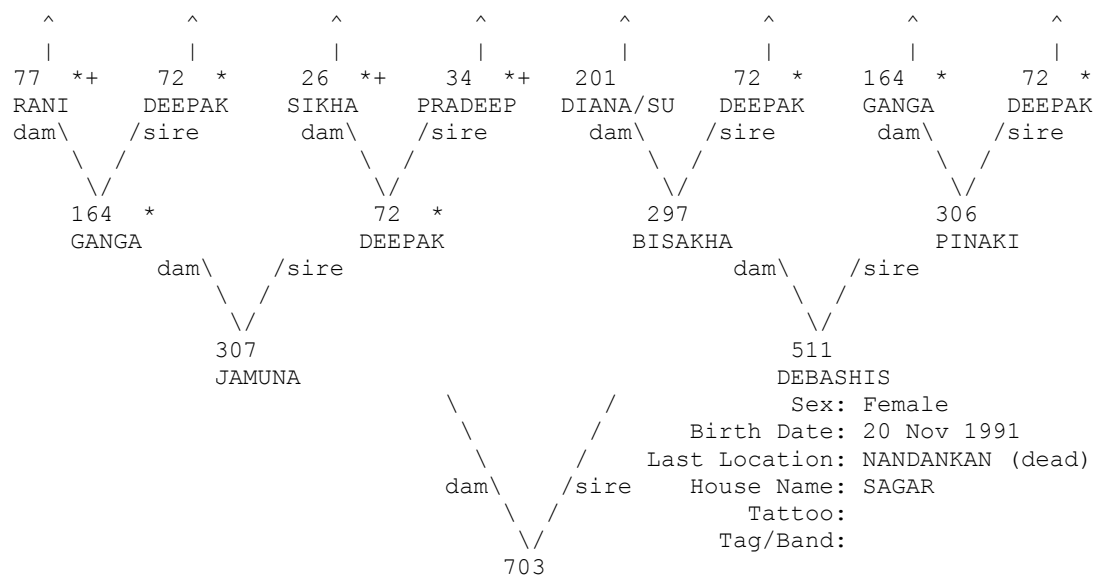

+ Wild-caught... * Appear more than once...
 ^ Pedigree continues beyond top of page...

=====
 Taxon Name: PANTHERA TIGRIS Studbook Number: 704
 =====

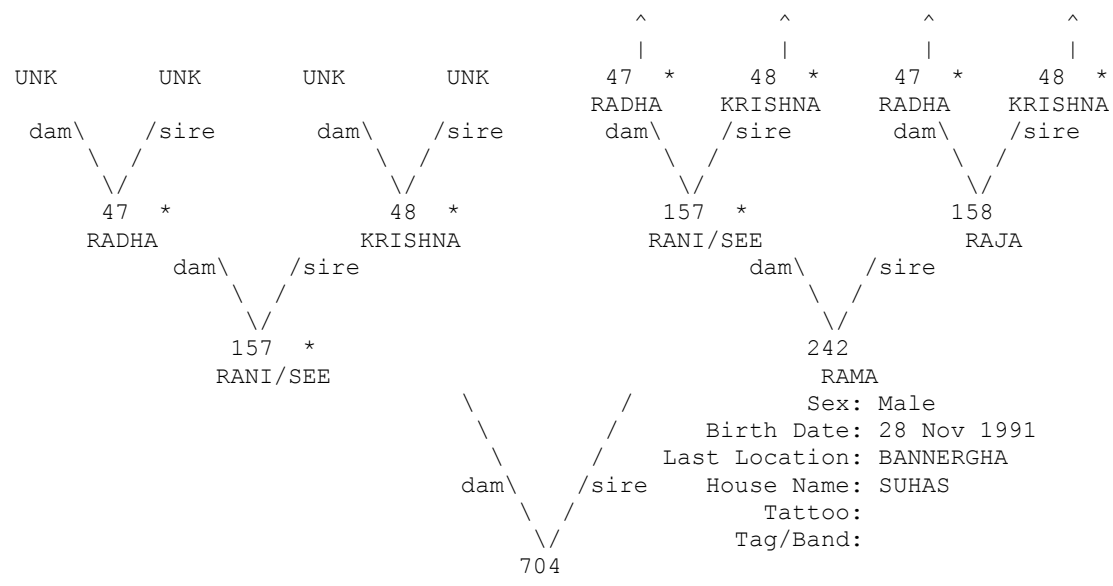

* Appear more than once...
 ^ Pedigree continues beyond top of page...

=====
 Taxon Name: PANTHERA TIGRIS Studbook Number: 705
 =====

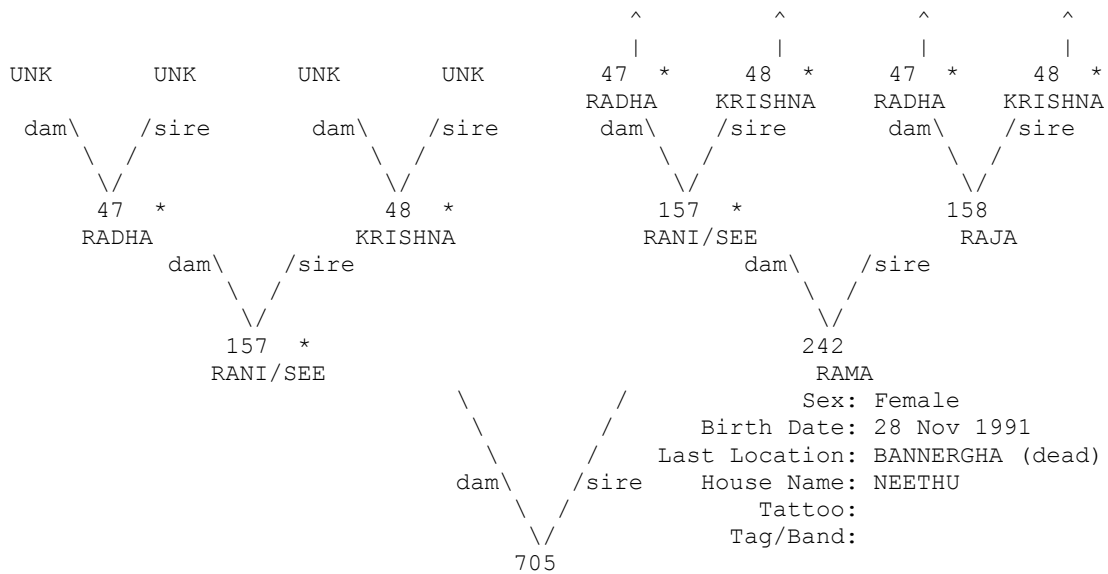

* Appear more than once...
 ^ Pedigree continues beyond top of page...

=====
 Taxon Name: PANTHERA TIGRIS Studbook Number: 706
 =====

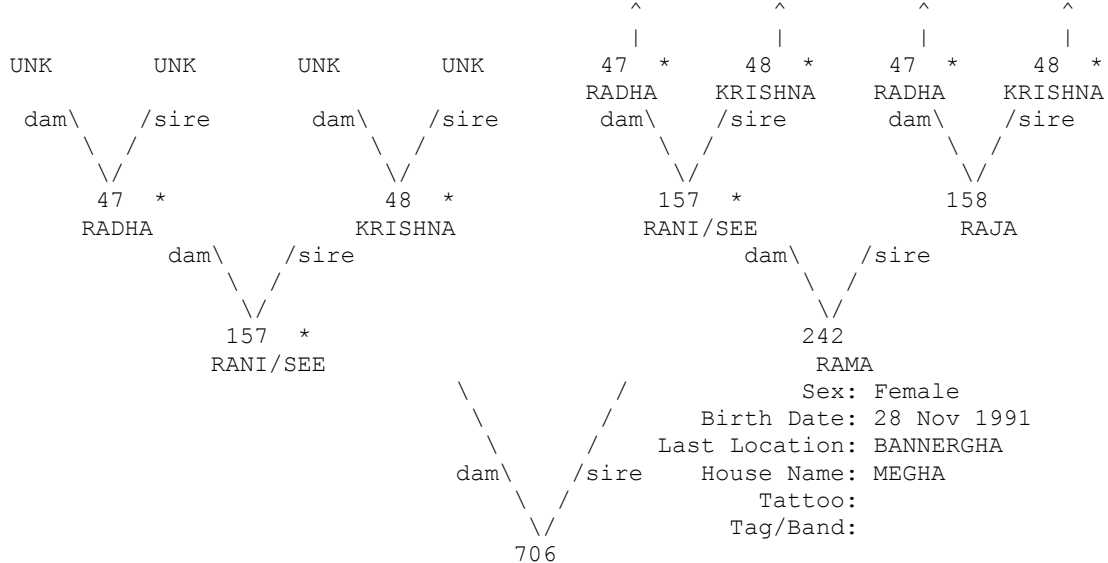

* Appear more than once...
 ^ Pedigree continues beyond top of page...

=====
 Taxon Name: PANTHERA TIGRIS Studbook Number: 709
 =====

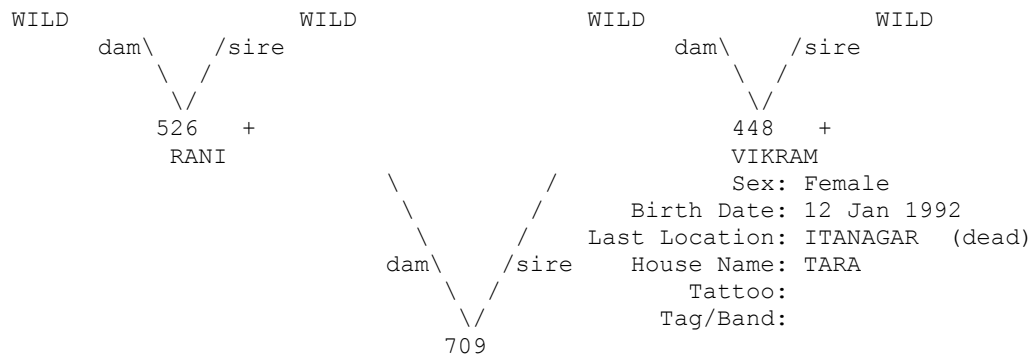

+ Wild-caught...

=====
 Taxon Name: PANTHERA TIGRIS Studbook Number: 710
 =====



+ Wild-caught...

=====
 Taxon Name: PANTHERA TIGRIS Studbook Number: 711
 =====

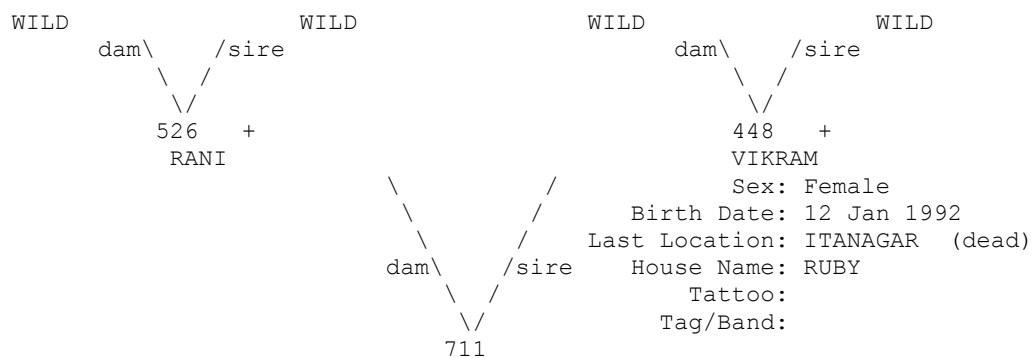

+ Wild-caught...

=====
 Taxon Name: PANTHERA TIGRIS Studbook Number: 715
 =====

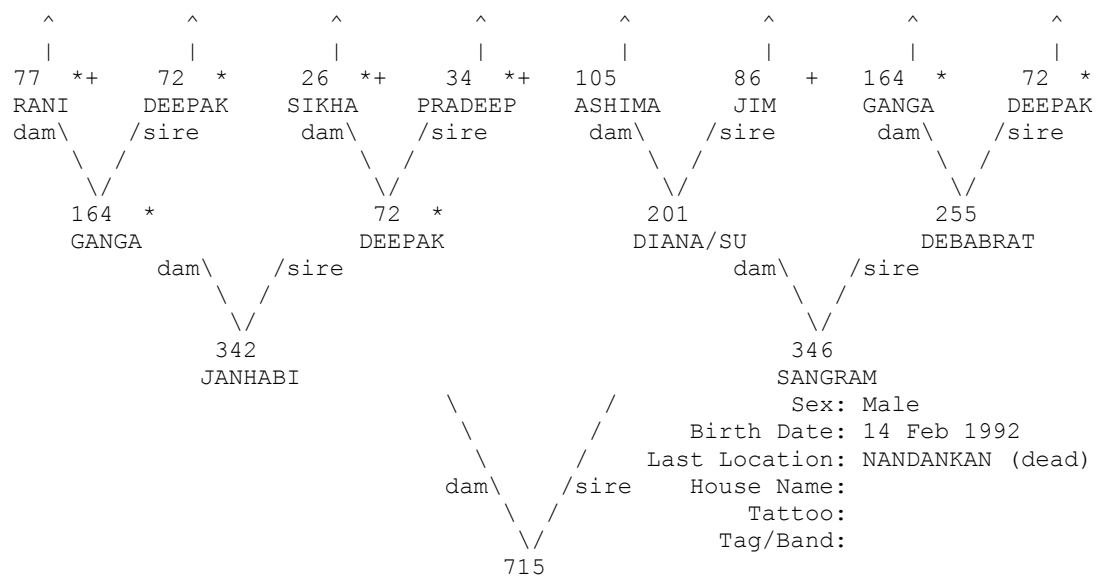

+ Wild-caught... * Appear more than once...
 ^ Pedigree continues beyond top of page...

=====
 Taxon Name: PANTHERA TIGRIS Studbook Number: 716
 =====

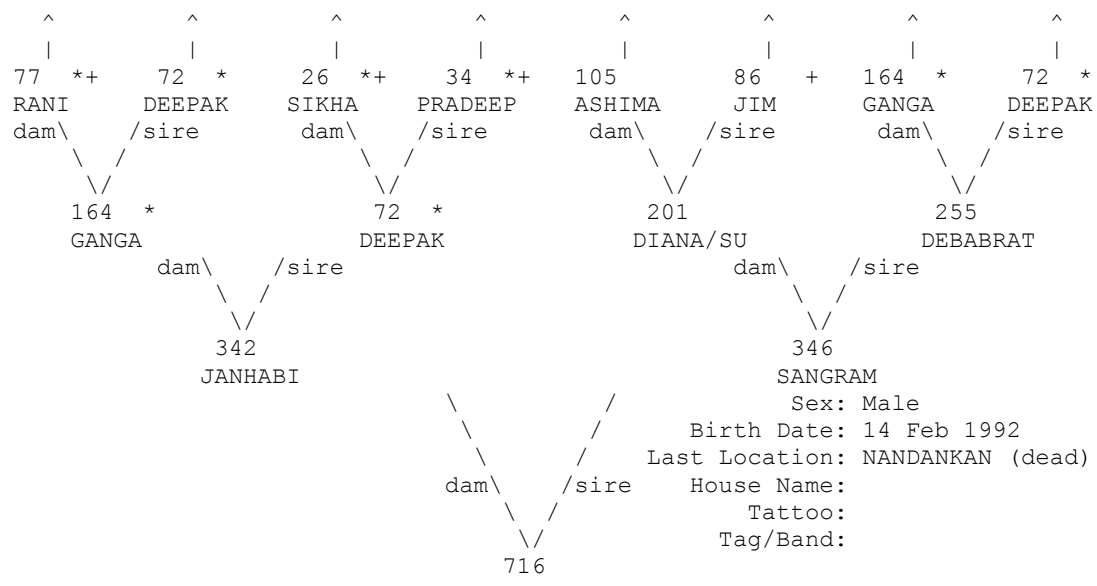

+ Wild-caught... * Appear more than once...
 ^ Pedigree continues beyond top of page...

=====
 Taxon Name: PANTHERA TIGRIS Studbook Number: 717
 =====

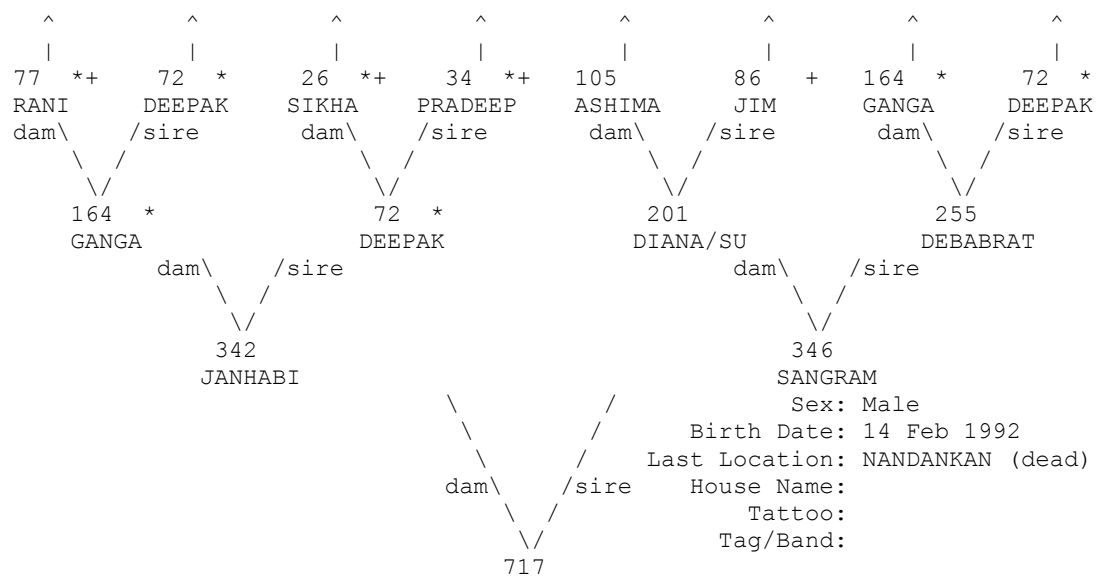

+ Wild-caught... * Appear more than once...
 ^ Pedigree continues beyond top of page...

=====
 Taxon Name: PANTHERA TIGRIS Studbook Number: 718
 =====

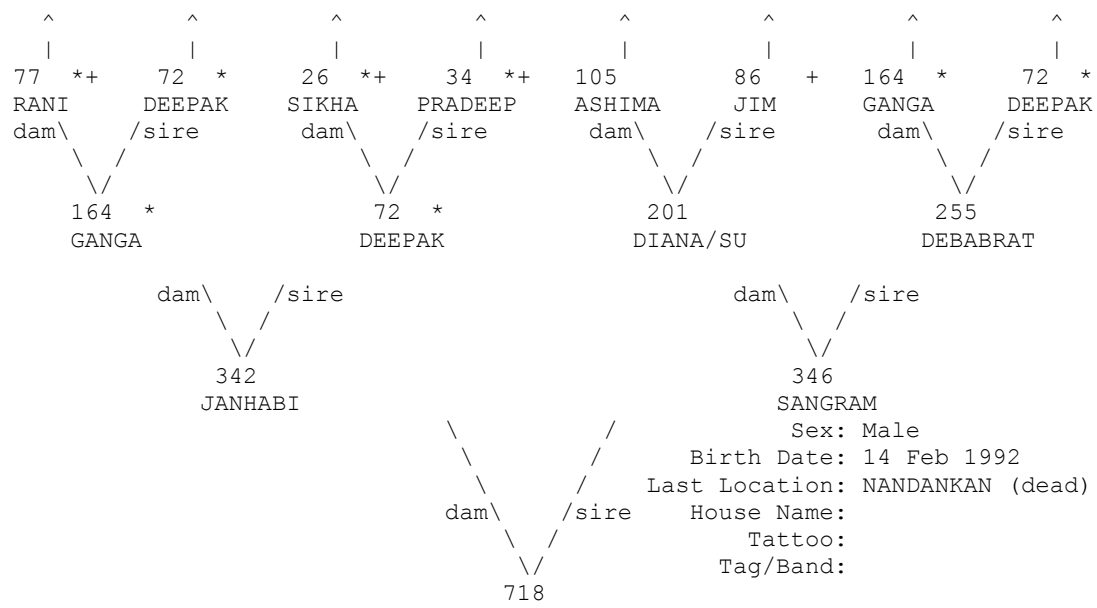

+ Wild-caught... * Appear more than once...
 ^ Pedigree continues beyond top of page...

=====
 Taxon Name: PANTHERA TIGRIS Studbook Number: 719
 =====

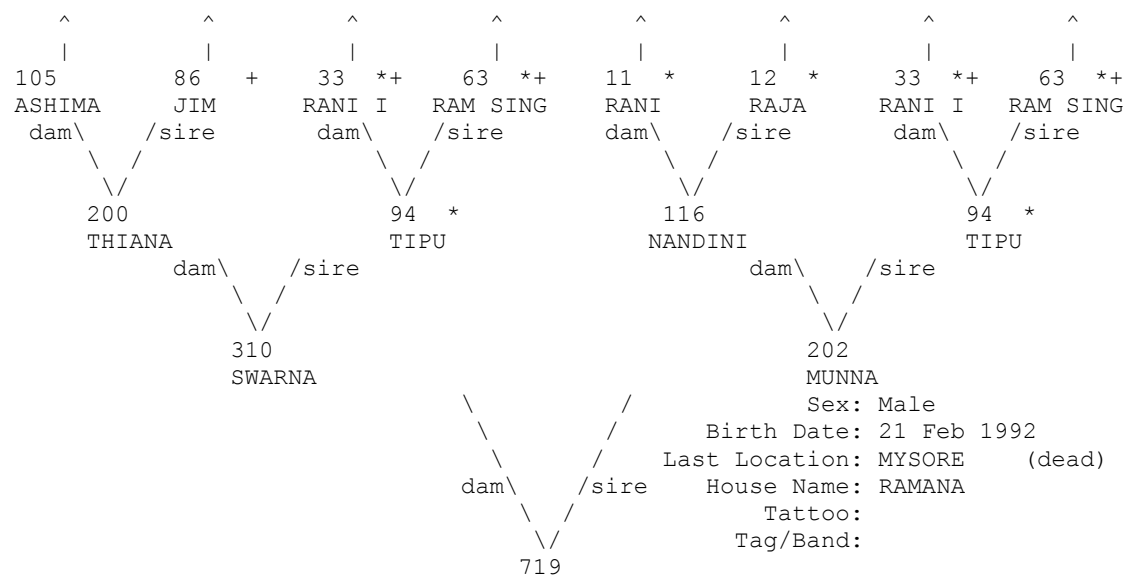

+ Wild-caught... * Appear more than once...
 ^ Pedigree continues beyond top of page...

=====
 Taxon Name: PANTHERA TIGRIS Studbook Number: 720
 =====

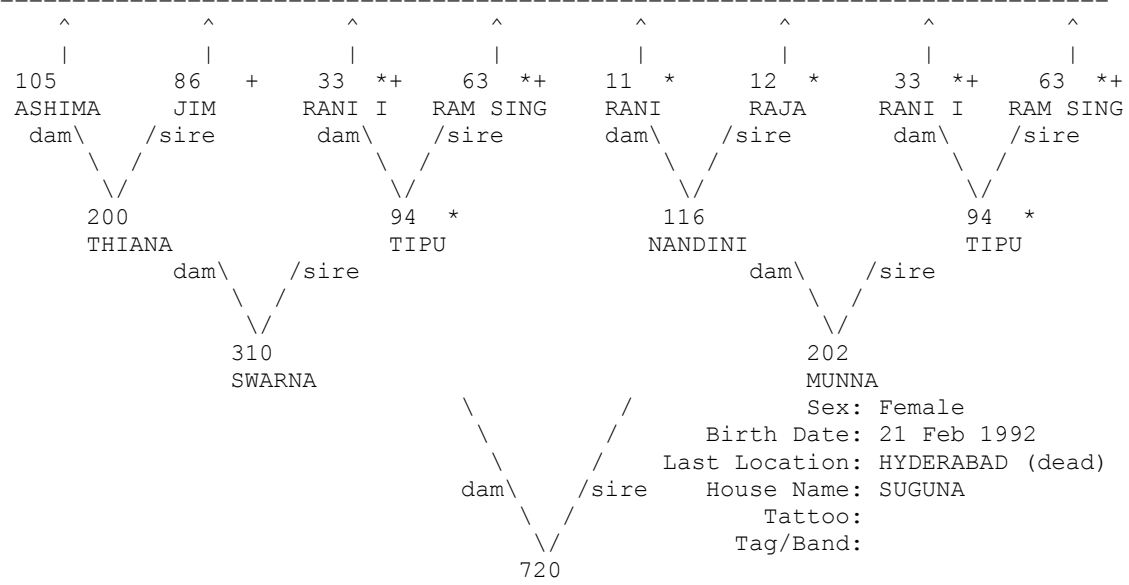

+ Wild-caught... * Appear more than once...
 ^ Pedigree continues beyond top of page...

=====

Taxon Name: PANTHERA TIGRIS Studbook Number: 721

=====

WILD

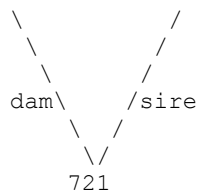

WILD

Sex: Female

Birth Date: ~ 1992

Last Location: HYDERABAD (dead)

House Name: MALLIKA

Tattoo:

Tag/Band:

=====

Taxon Name: PANTHERA TIGRIS Studbook Number: 722

=====

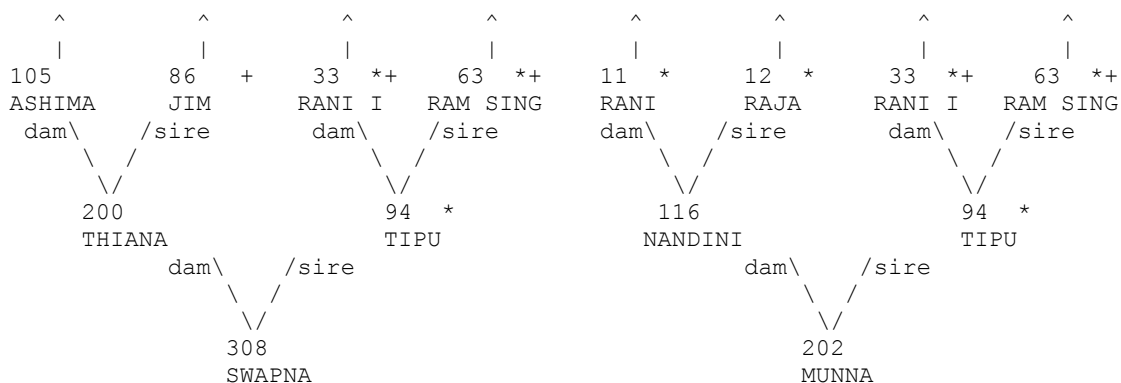

Sex: Male

Birth Date: 1 Apr 1992

Last Location: HYDERABAD (dead)

House Name: KHANNA

Tattoo:

Tag/Band:

+ Wild-caught... * Appear more than once...

^ Pedigree continues beyond top of page...

=====

Taxon Name: PANTHERA TIGRIS Studbook Number: 723

=====

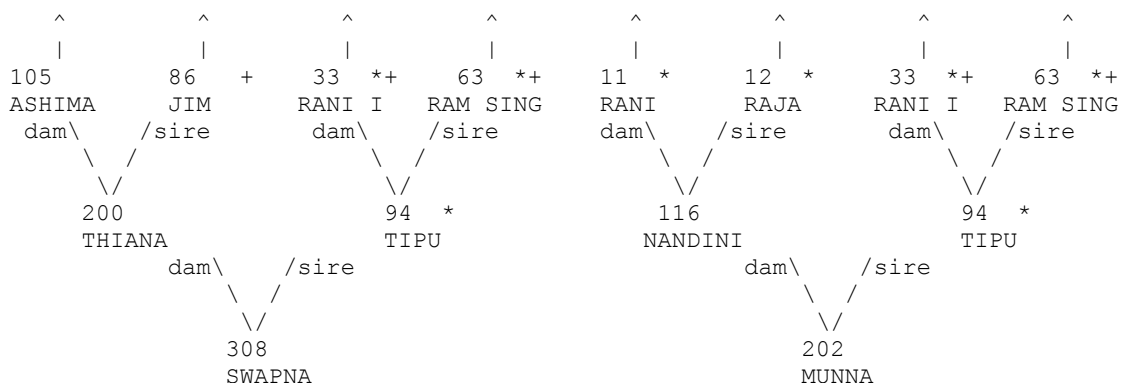

Sex: Female

Birth Date: 1 Apr 1992

Last Location: HYDERABAD (dead)

House Name: HENA

Tattoo:

Tag/Band:

+ Wild-caught... * Appear more than once...

^ Pedigree continues beyond top of page...

=====
 Taxon Name: PANTHERA TIGRIS Studbook Number: 724
 =====

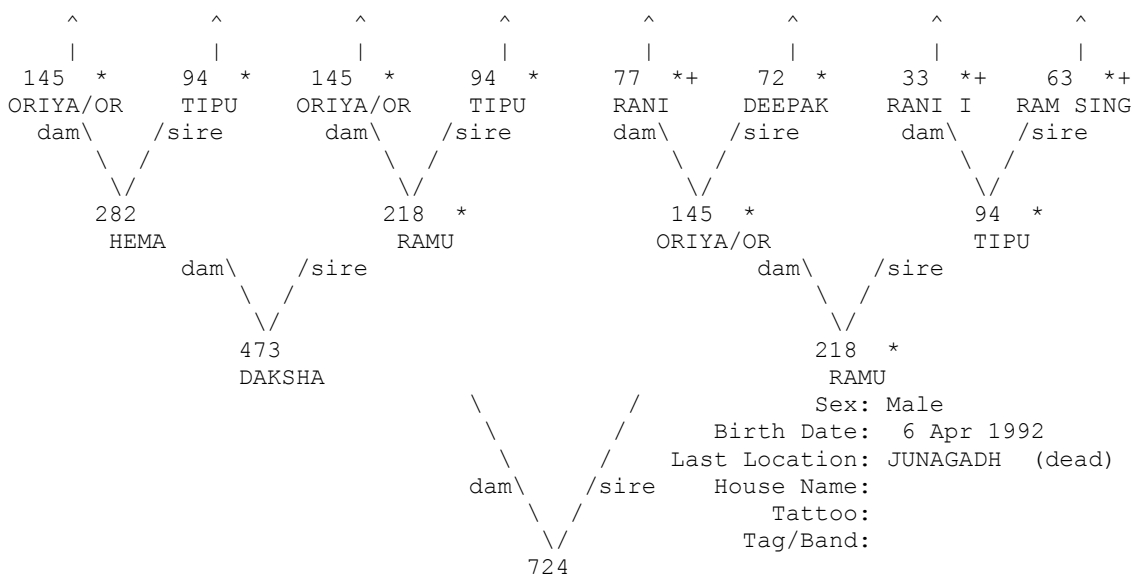

+ Wild-caught... * Appear more than once...
 ^ Pedigree continues beyond top of page...

=====
 Taxon Name: PANTHERA TIGRIS Studbook Number: 725
 =====

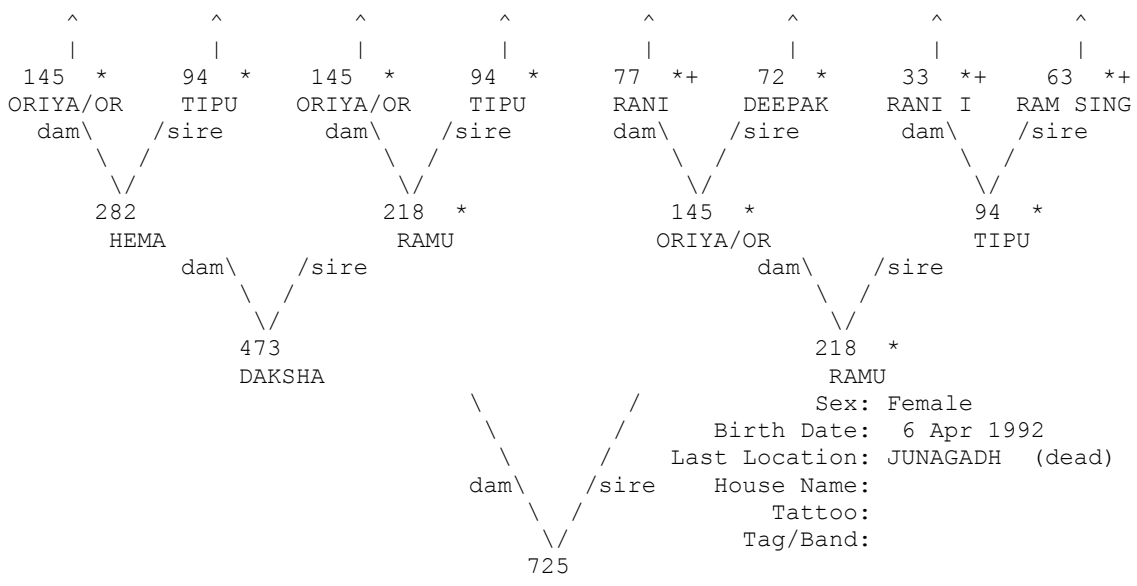

+ Wild-caught... * Appear more than once...
 ^ Pedigree continues beyond top of page...

=====

Taxon Name: PANTHERA TIGRIS Studbook Number: 726

=====

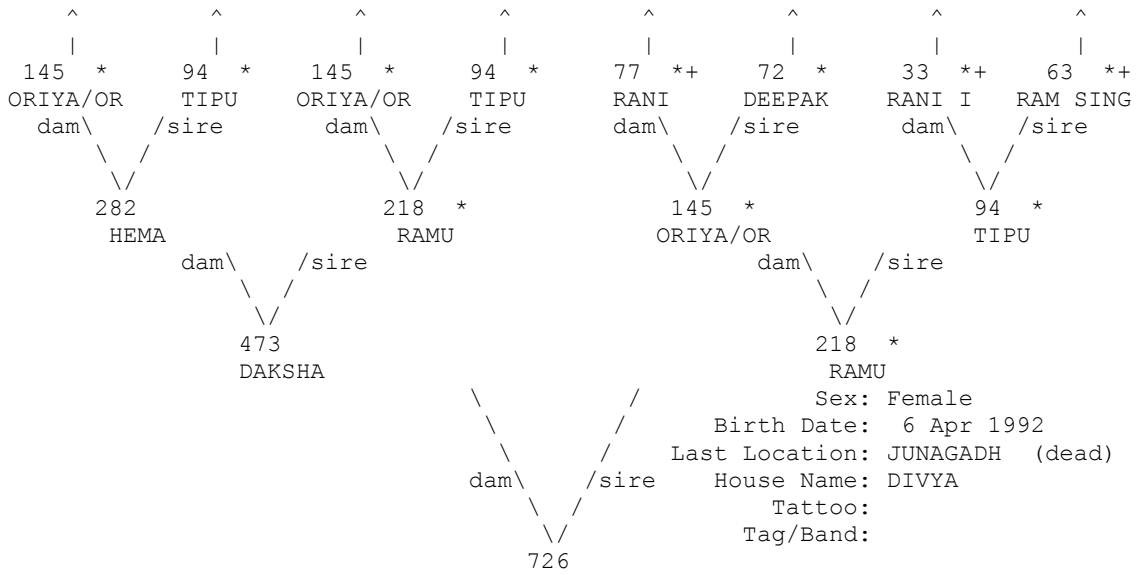

+ Wild-caught... * Appear more than once...
 ^ Pedigree continues beyond top of page...

=====

Taxon Name: PANTHERA TIGRIS Studbook Number: 727

=====

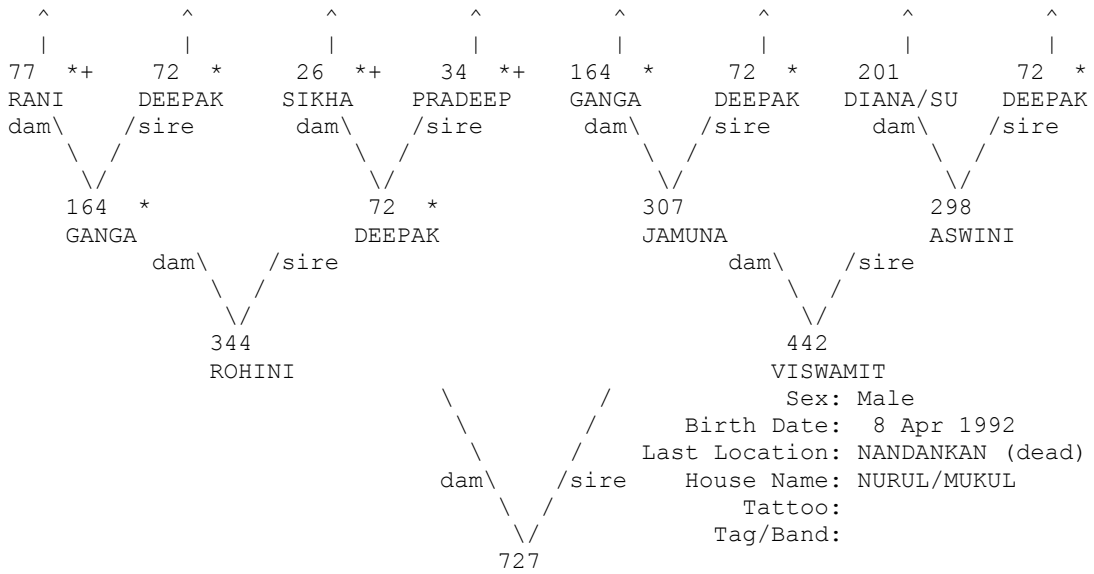

+ Wild-caught... * Appear more than once...
 ^ Pedigree continues beyond top of page...

=====
 Taxon Name: PANTHERA TIGRIS Studbook Number: 728
 =====

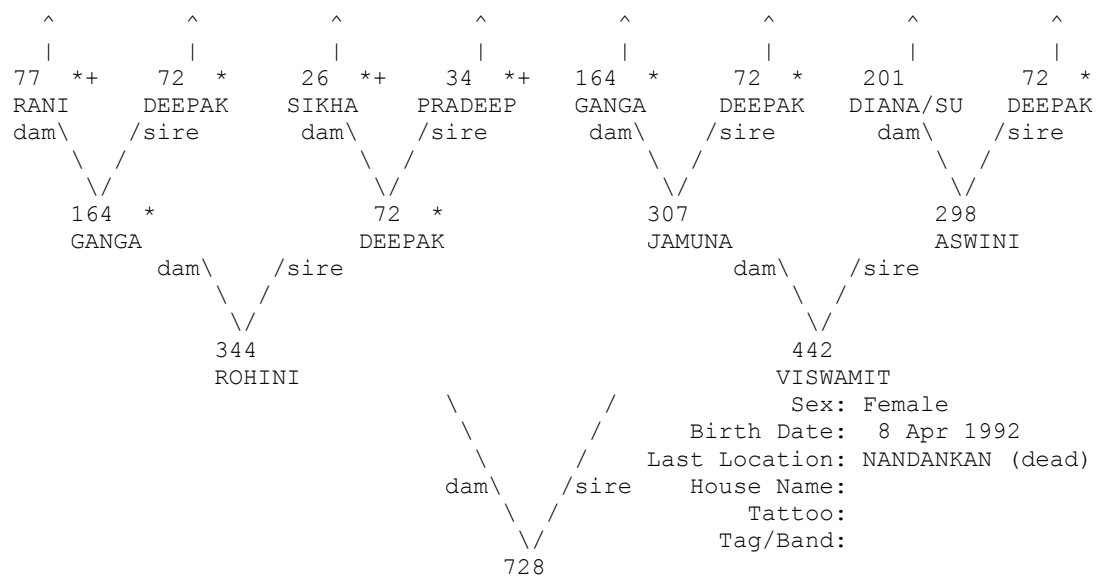

+ Wild-caught... * Appear more than once...
 ^ Pedigree continues beyond top of page...

=====
 Taxon Name: PANTHERA TIGRIS Studbook Number: 729
 =====

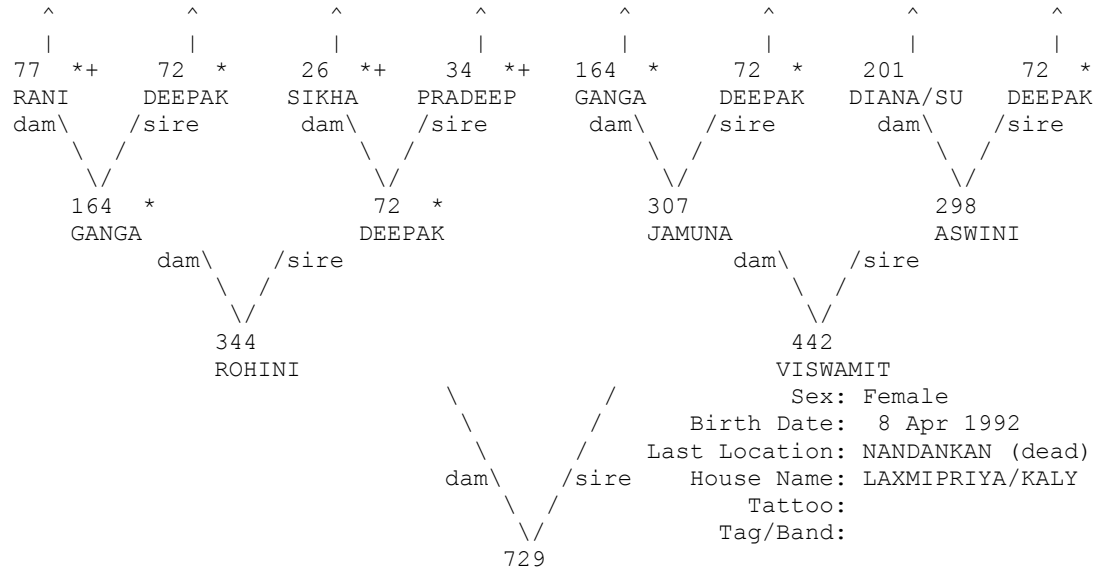

+ Wild-caught... * Appear more than once...
 ^ Pedigree continues beyond top of page...

=====
 Taxon Name: PANTHERA TIGRIS Studbook Number: 730
 =====

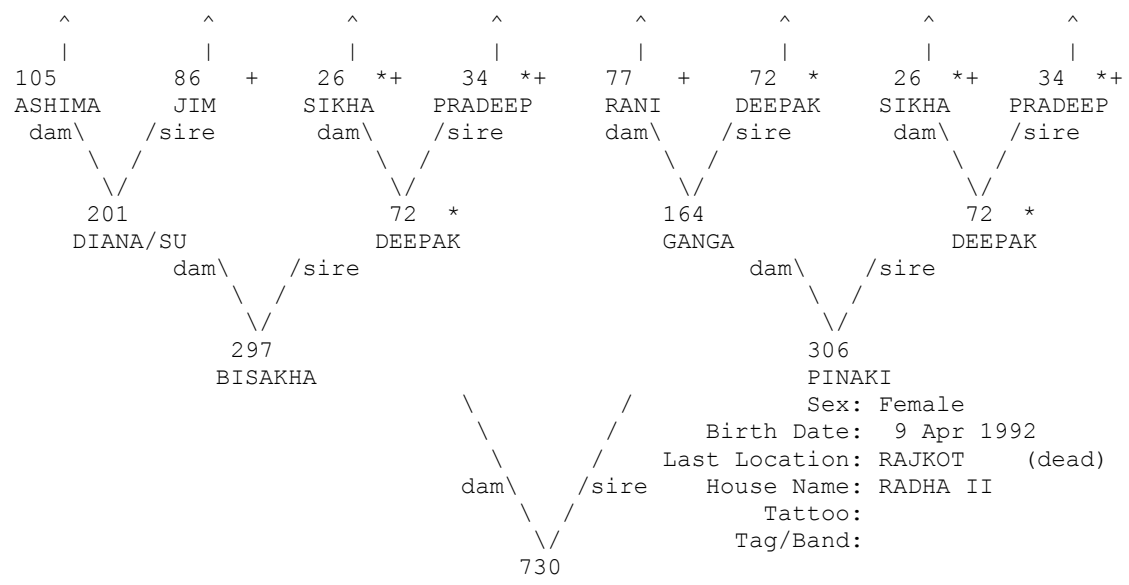

+ Wild-caught... * Appear more than once...
 ^ Pedigree continues beyond top of page...

=====
 Taxon Name: PANTHERA TIGRIS Studbook Number: 731
 =====

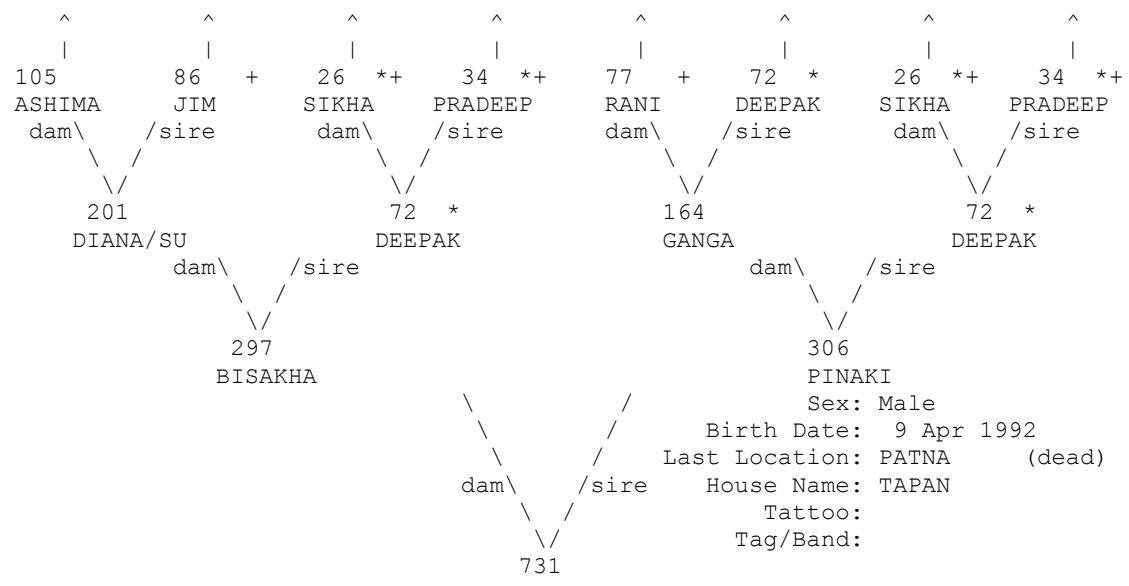

+ Wild-caught... * Appear more than once...
 ^ Pedigree continues beyond top of page...

=====
 Taxon Name: PANTHERA TIGRIS Studbook Number: 732
 =====

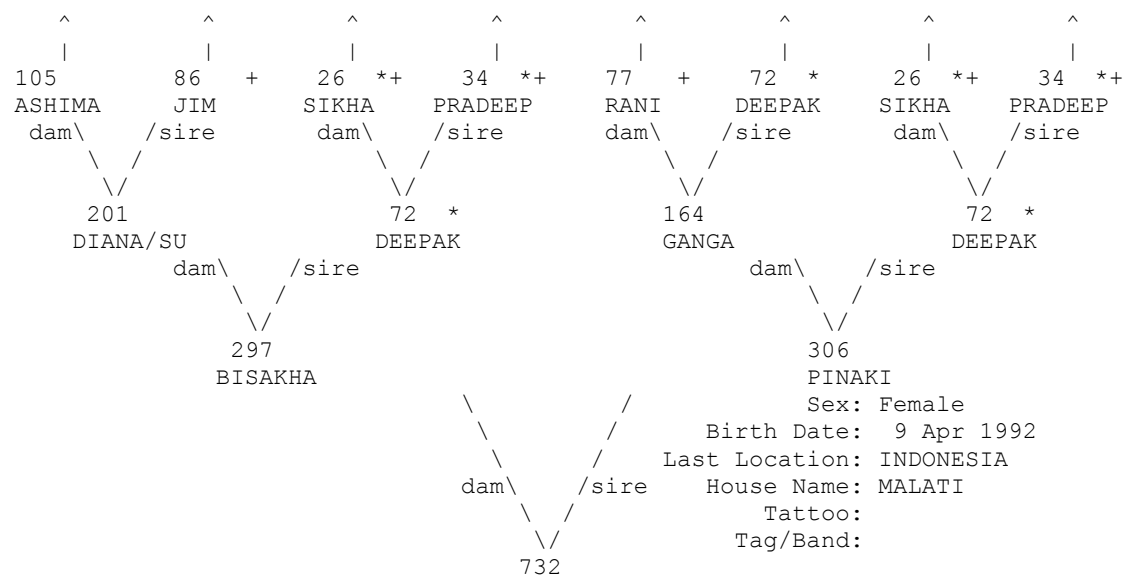

+ Wild-caught... * Appear more than once...
 ^ Pedigree continues beyond top of page...

=====
 Taxon Name: PANTHERA TIGRIS Studbook Number: 733
 =====

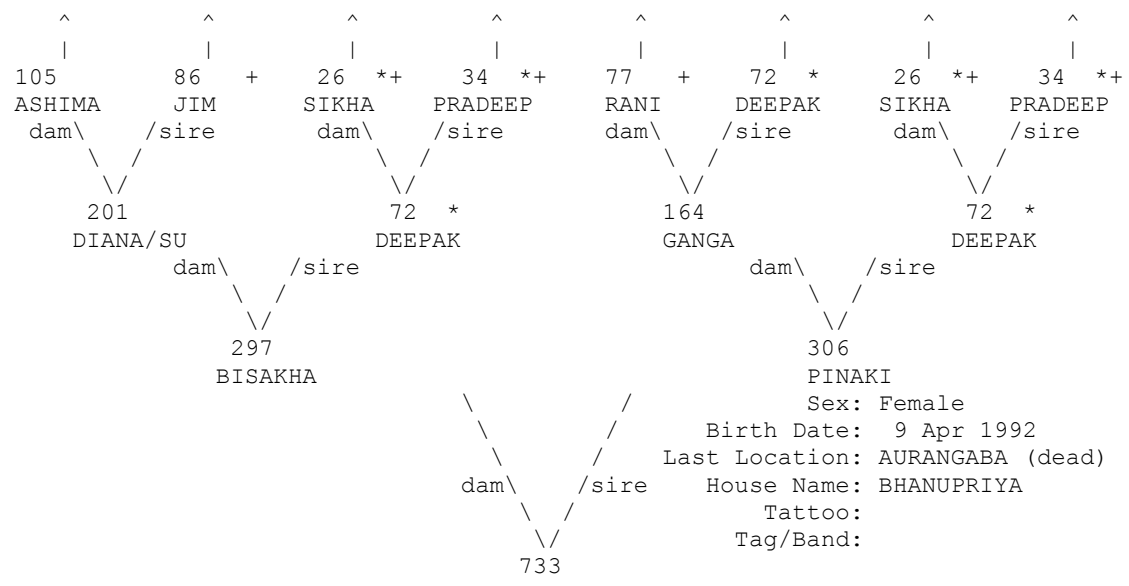

+ Wild-caught... * Appear more than once...
 ^ Pedigree continues beyond top of page...

=====
 Taxon Name: PANTHERA TIGRIS Studbook Number: 734
 =====

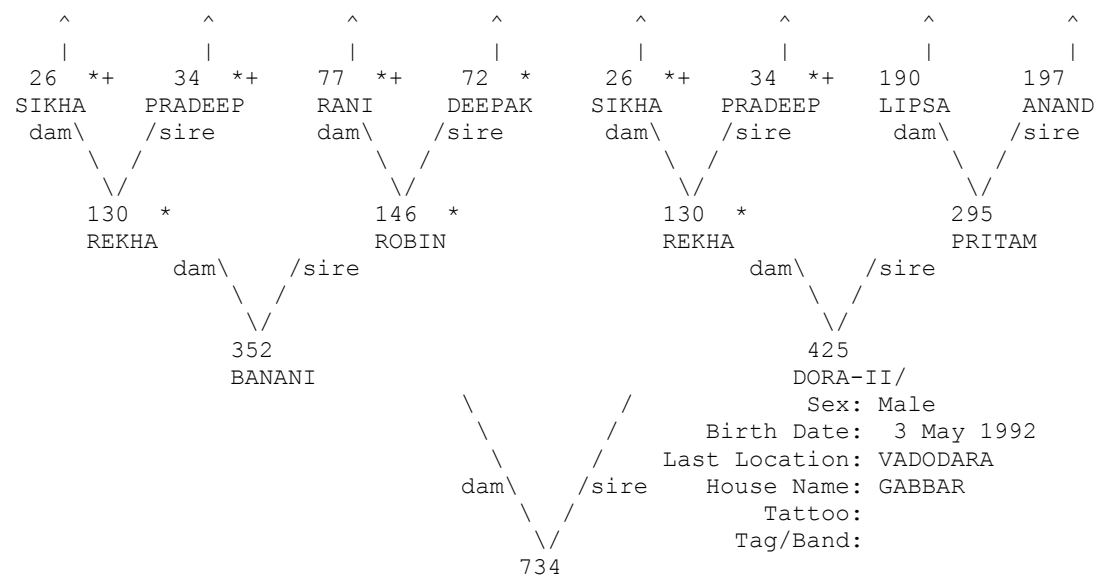

+ Wild-caught... * Appear more than once...
 ^ Pedigree continues beyond top of page...

=====
 Taxon Name: PANTHERA TIGRIS Studbook Number: 735
 =====

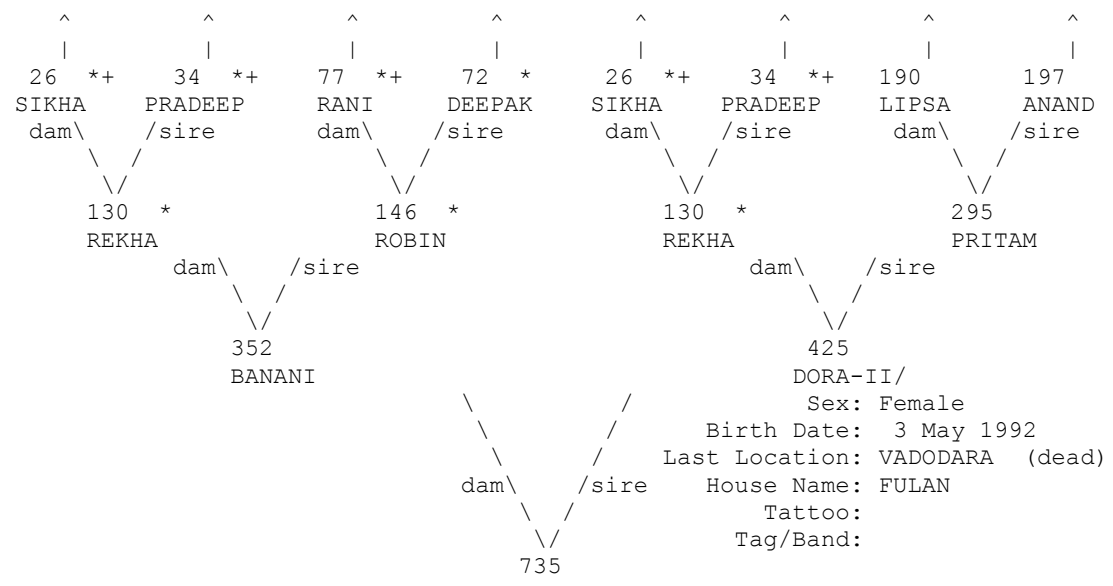

+ Wild-caught... * Appear more than once...
 ^ Pedigree continues beyond top of page...

=====

Taxon Name: PANTHERA TIGRIS Studbook Number: 736

=====

UNK

UNK

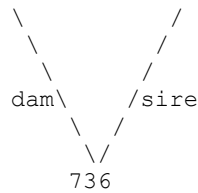

Sex: Female

Birth Date: 3 May 1992

Last Location: TRICHUR (dead)

House Name:

Tattoo:

Tag/Band:

=====

Taxon Name: PANTHERA TIGRIS Studbook Number: 737

=====

UNK

UNK

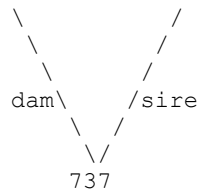

Sex: Male

Birth Date: 3 May 1992

Last Location: TRICHUR (dead)

House Name:

Tattoo:

Tag/Band:

=====

Taxon Name: PANTHERA TIGRIS Studbook Number: 738

=====

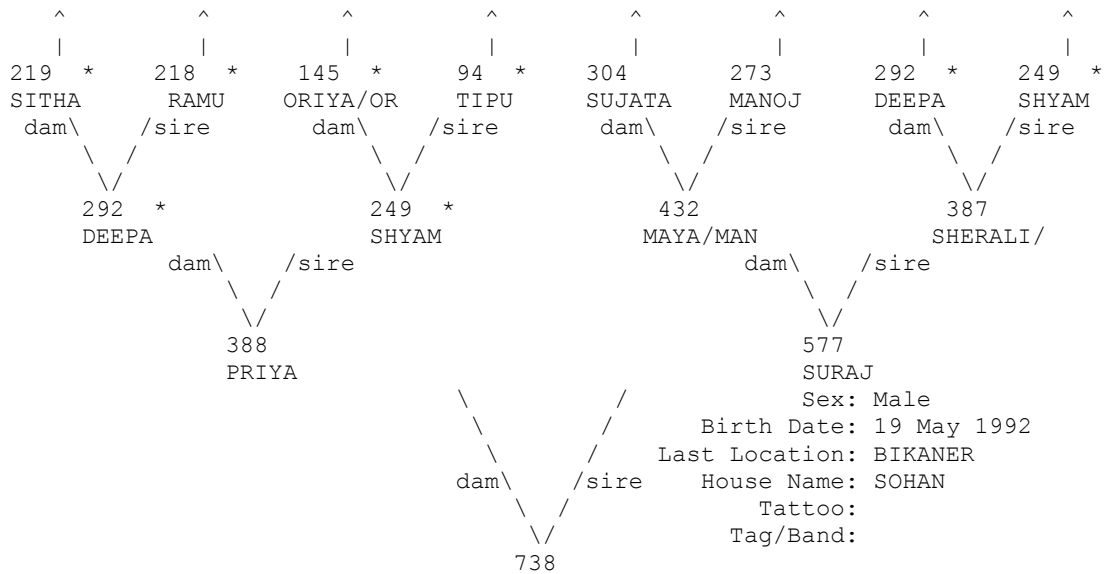

Sex: Male

Birth Date: 19 May 1992

Last Location: BIKANER

House Name: SOHAN

Tattoo:

Tag/Band:

* Appear more than once...

^ Pedigree continues beyond top of page...

=====
 Taxon Name: PANTHERA TIGRIS Studbook Number: 739
 =====

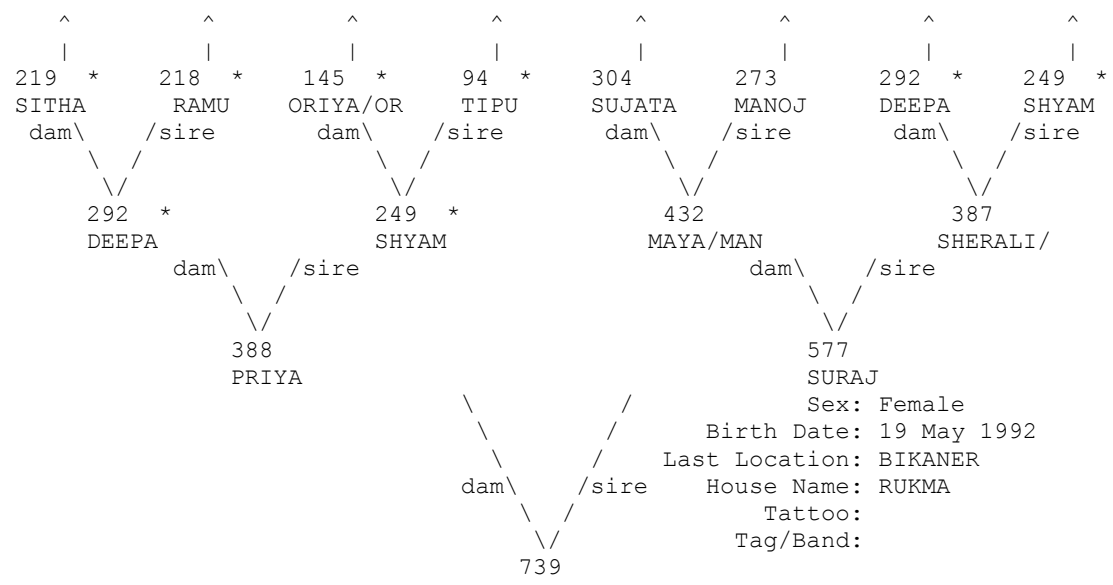

* Appear more than once...
 ^ Pedigree continues beyond top of page...

=====
 Taxon Name: PANTHERA TIGRIS Studbook Number: 740
 =====

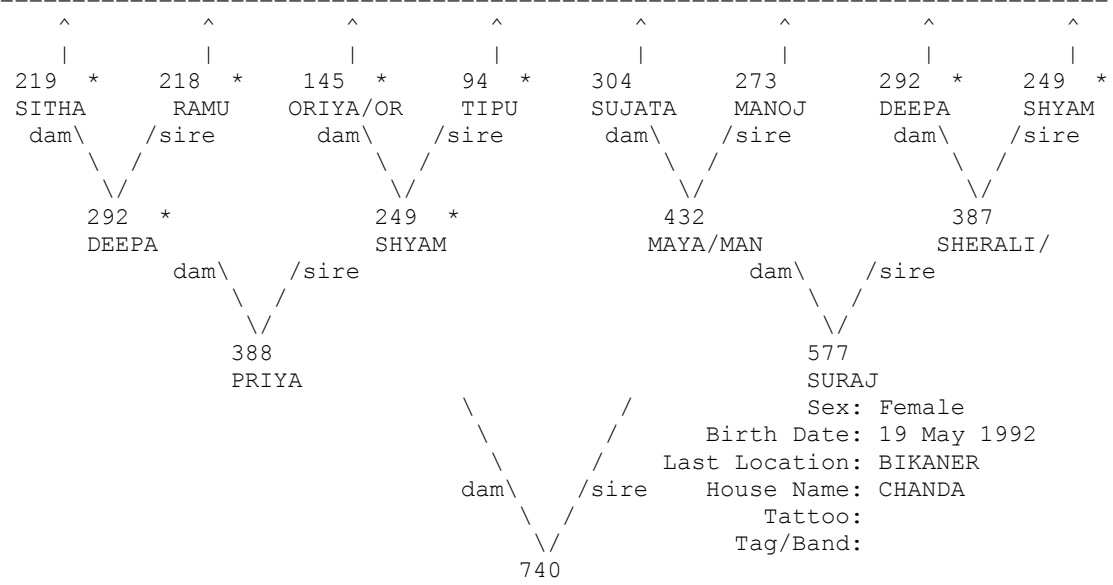

* Appear more than once...
 ^ Pedigree continues beyond top of page...

=====
 Taxon Name: PANTHERA TIGRIS Studbook Number: 741
 =====

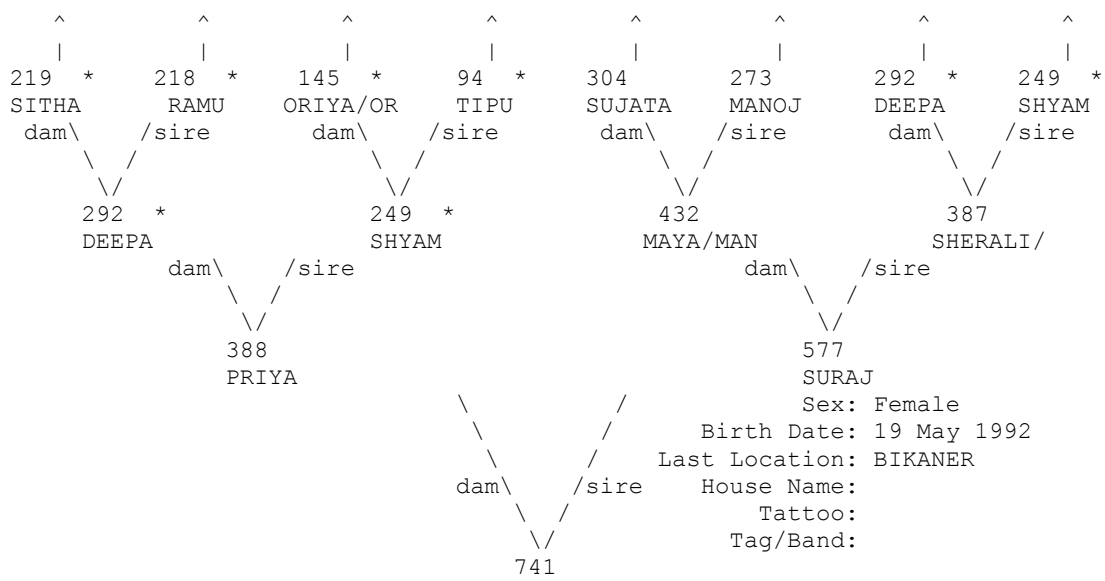

* Appear more than once...
 ^ Pedigree continues beyond top of page...

=====
 Taxon Name: PANTHERA TIGRIS Studbook Number: 742
 =====

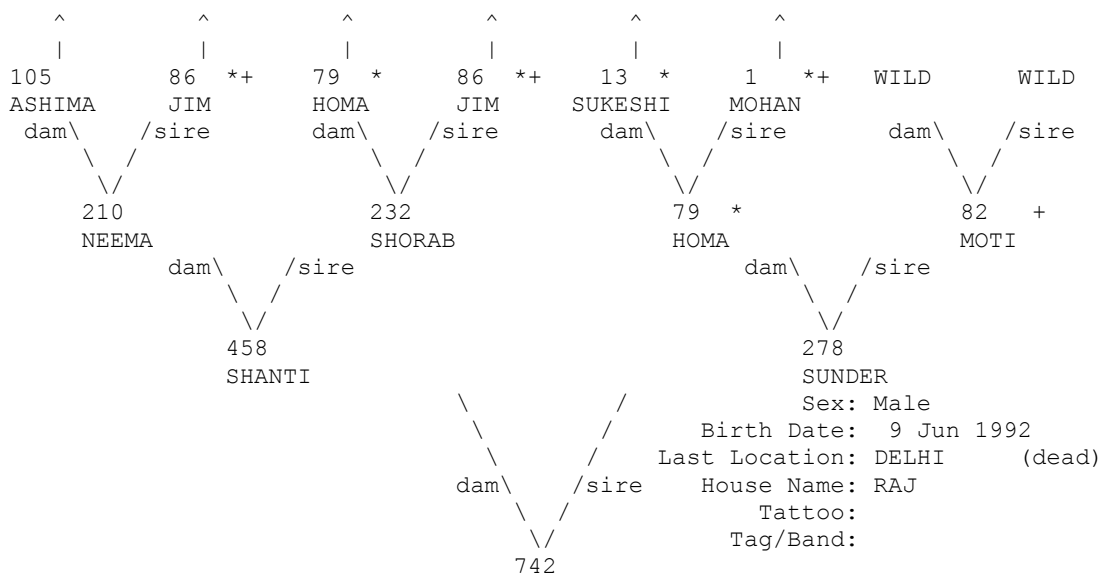

+ Wild-caught... * Appear more than once...
 ^ Pedigree continues beyond top of page...

=====
 Taxon Name: PANTHERA TIGRIS Studbook Number: 743
 =====

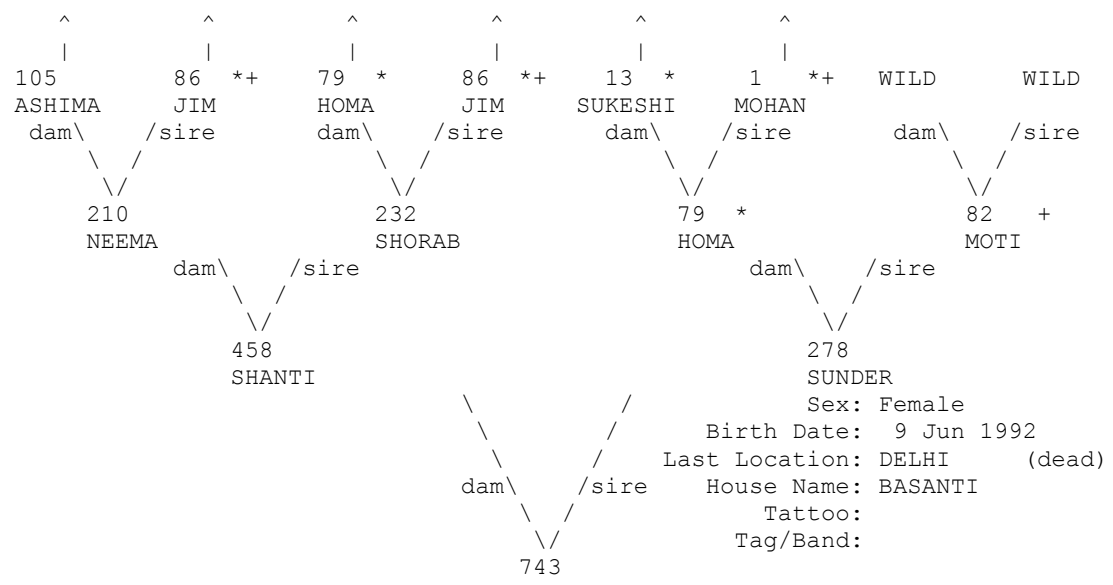

+ Wild-caught... * Appear more than once...
 ^ Pedigree continues beyond top of page...

=====
 Taxon Name: PANTHERA TIGRIS Studbook Number: 744
 =====

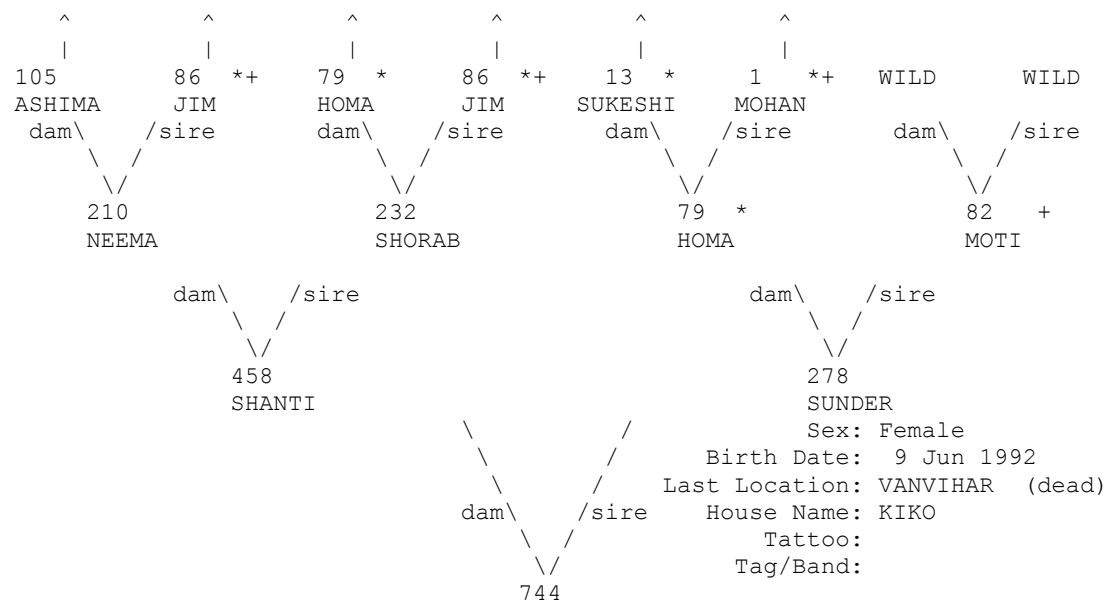

+ Wild-caught... * Appear more than once...
 ^ Pedigree continues beyond top of page...

=====
 Taxon Name: PANTHERA TIGRIS Studbook Number: 745
 =====

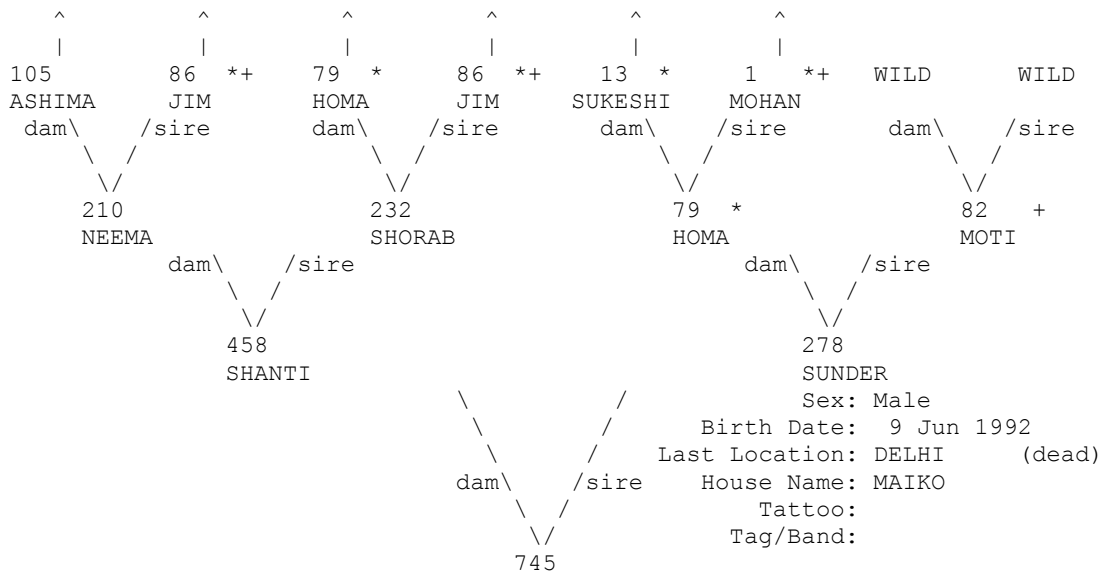

+ Wild-caught... * Appear more than once...
 ^ Pedigree continues beyond top of page...

=====
 Taxon Name: PANTHERA TIGRIS Studbook Number: 746
 =====

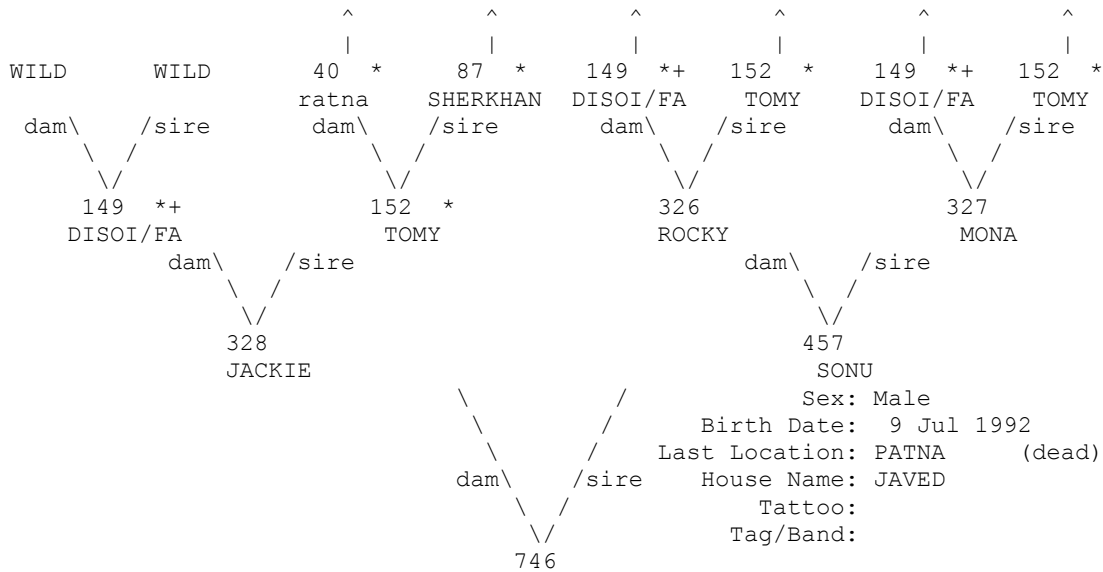

+ Wild-caught... * Appear more than once...
 ^ Pedigree continues beyond top of page...

=====
 Taxon Name: PANTHERA TIGRIS Studbook Number: 747
 =====

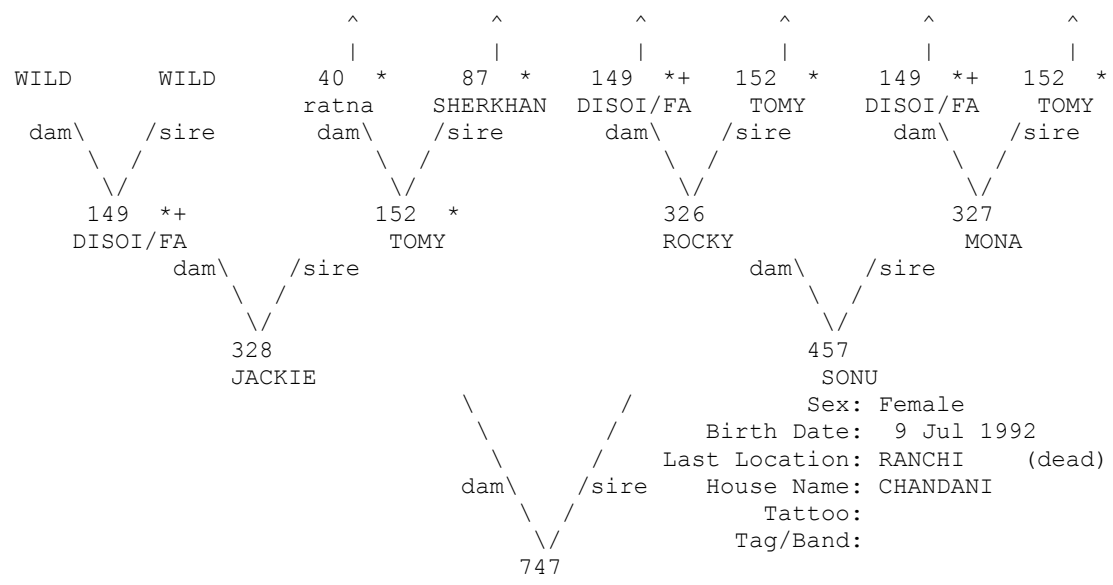

+ Wild-caught... * Appear more than once...
 ^ Pedigree continues beyond top of page...

=====
 Taxon Name: PANTHERA TIGRIS Studbook Number: 748
 =====

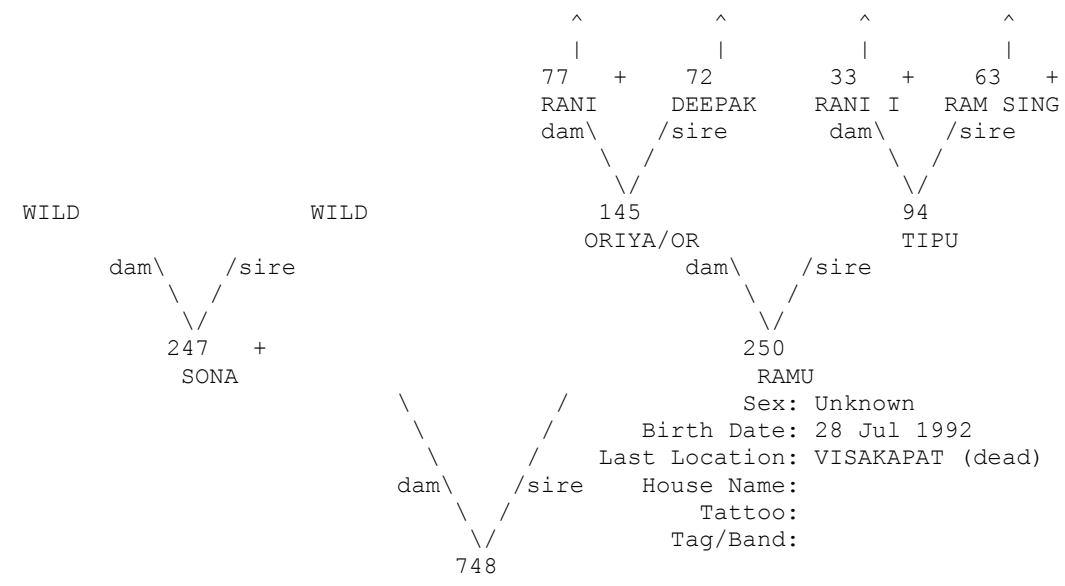

+ Wild-caught...
 ^ Pedigree continues beyond top of page...

=====
 Taxon Name: PANTHERA TIGRIS Studbook Number: 749
 =====

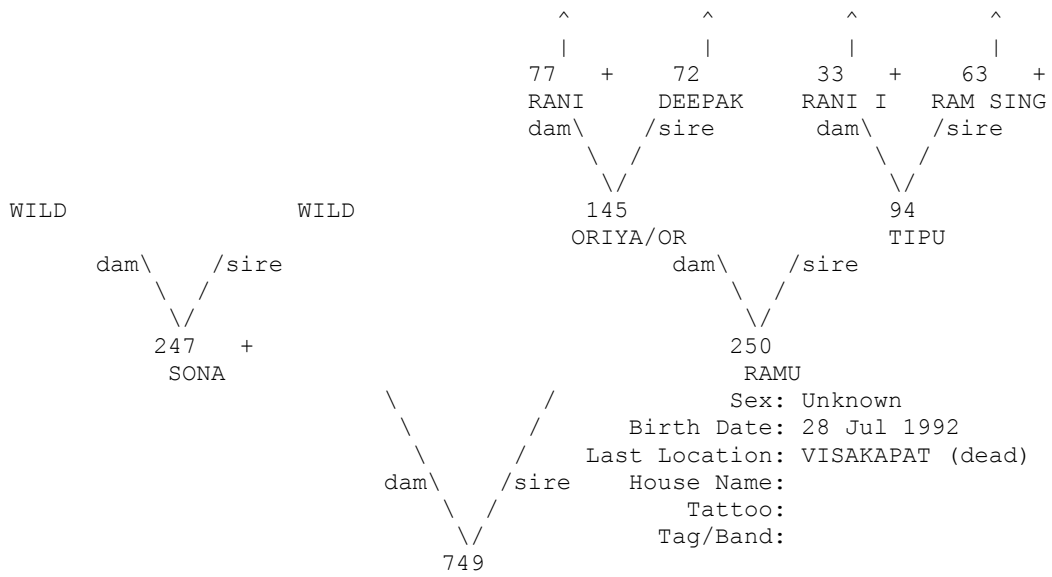

+ Wild-caught...
 ^ Pedigree continues beyond top of page...

=====
 Taxon Name: PANTHERA TIGRIS Studbook Number: 750
 =====

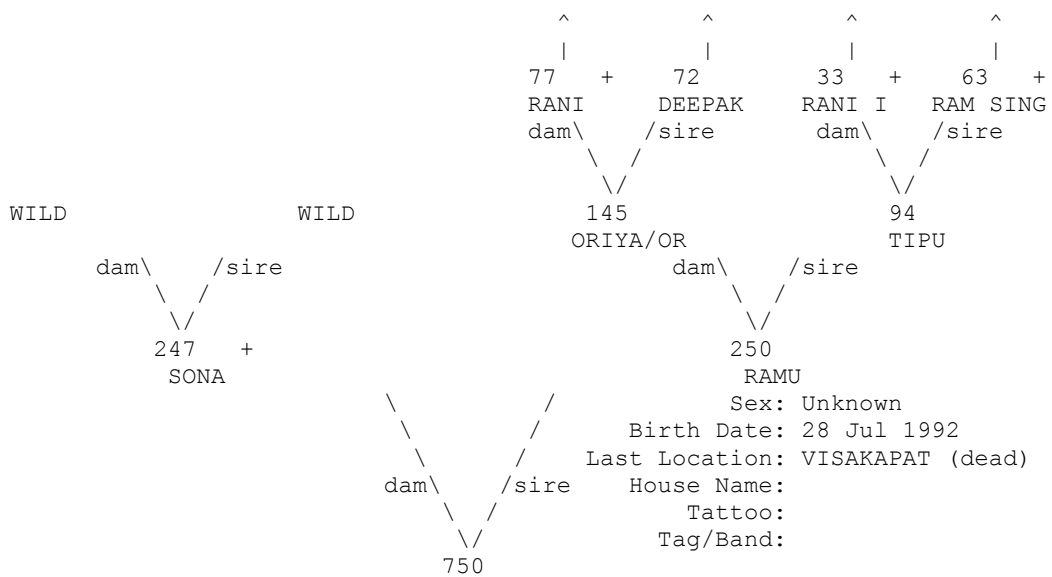

+ Wild-caught...
 ^ Pedigree continues beyond top of page...

=====
 Taxon Name: PANTHERA TIGRIS Studbook Number: 751
 =====

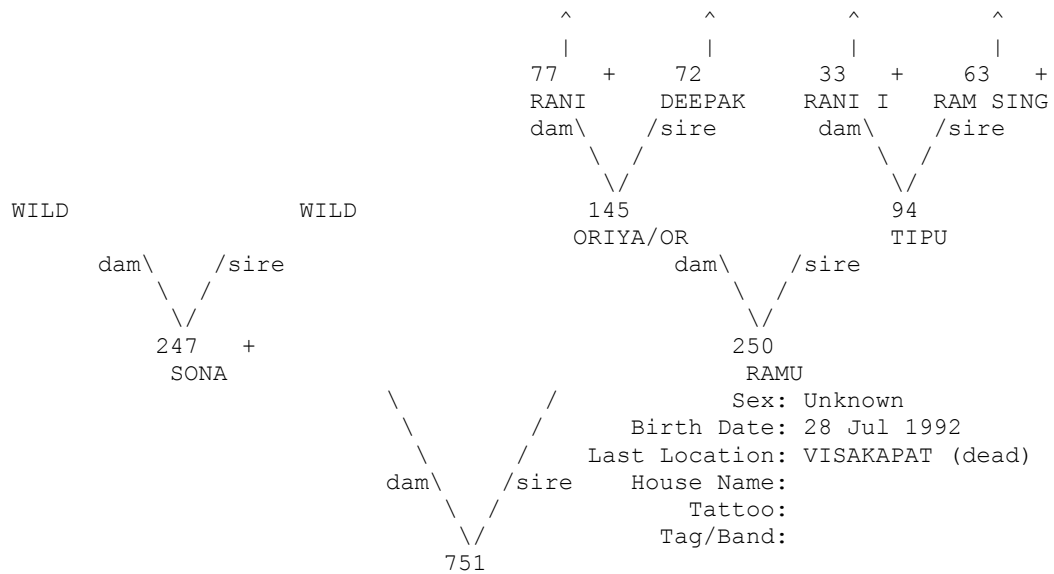

+ Wild-caught...
 ^ Pedigree continues beyond top of page...

=====
 Taxon Name: PANTHERA TIGRIS Studbook Number: 752
 =====

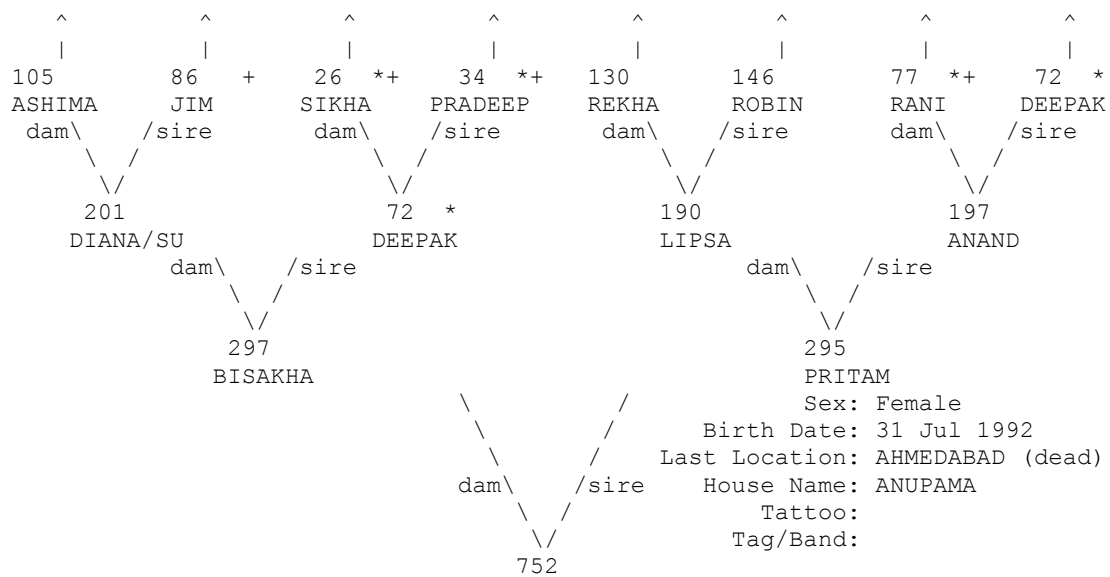

+ Wild-caught... * Appear more than once...
 ^ Pedigree continues beyond top of page...

=====
 Taxon Name: PANTHERA TIGRIS Studbook Number: 753
 =====

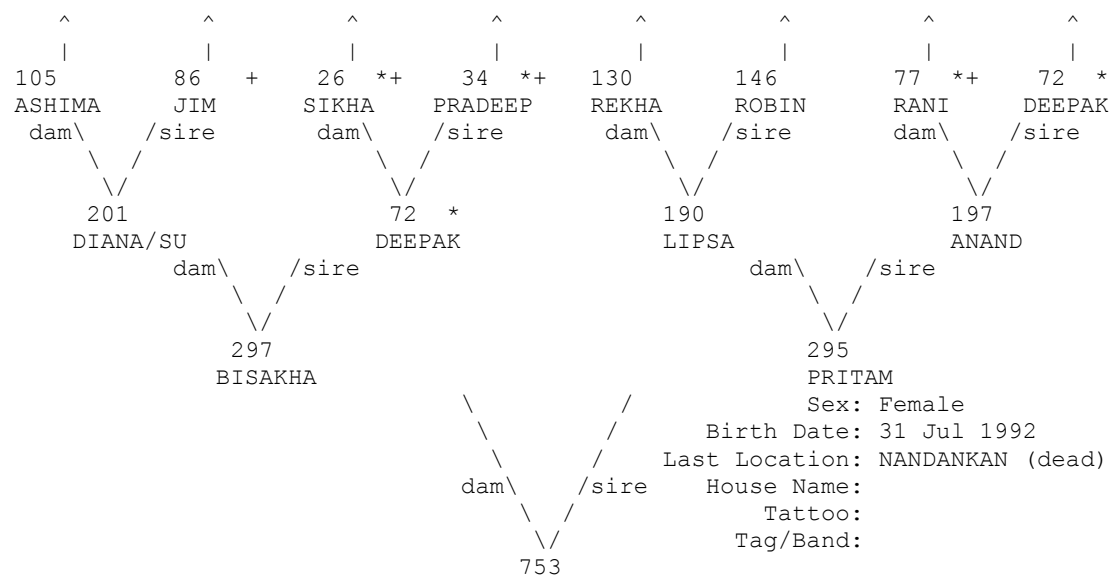

+ Wild-caught... * Appear more than once...
 ^ Pedigree continues beyond top of page...

=====
 Taxon Name: PANTHERA TIGRIS Studbook Number: 754
 =====

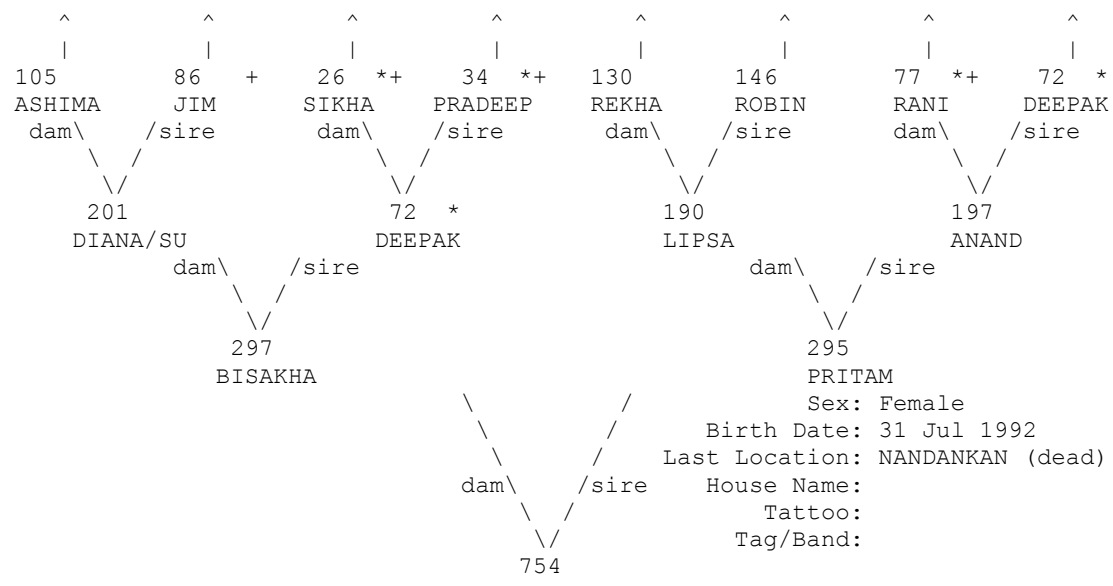

+ Wild-caught... * Appear more than once...
 ^ Pedigree continues beyond top of page...

=====
 Taxon Name: PANTHERA TIGRIS Studbook Number: 755
 =====

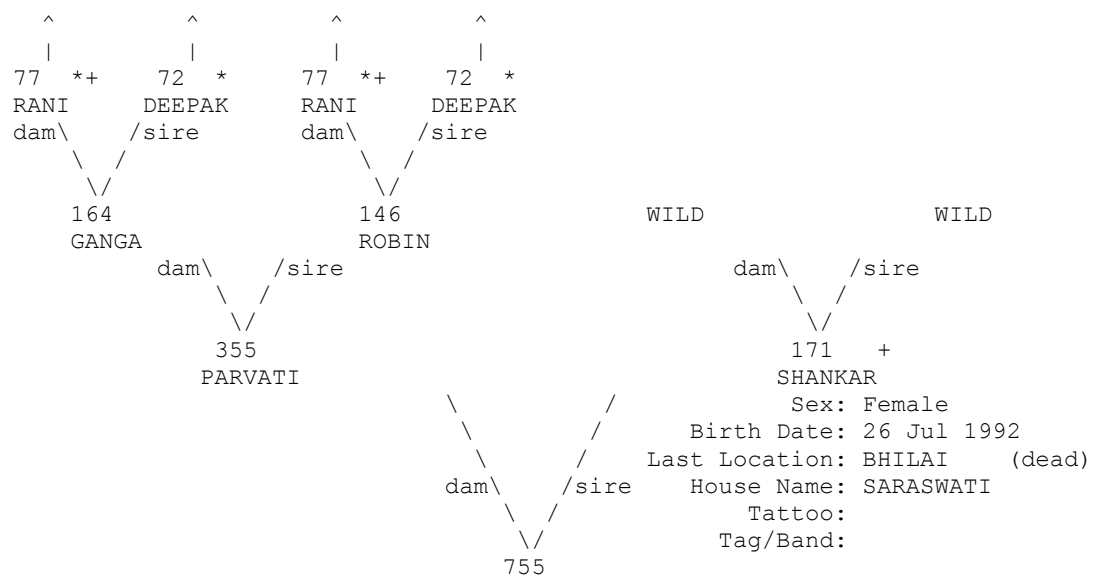

+ Wild-caught... * Appear more than once...
 ^ Pedigree continues beyond top of page...

=====
 Taxon Name: PANTHERA TIGRIS Studbook Number: 756
 =====

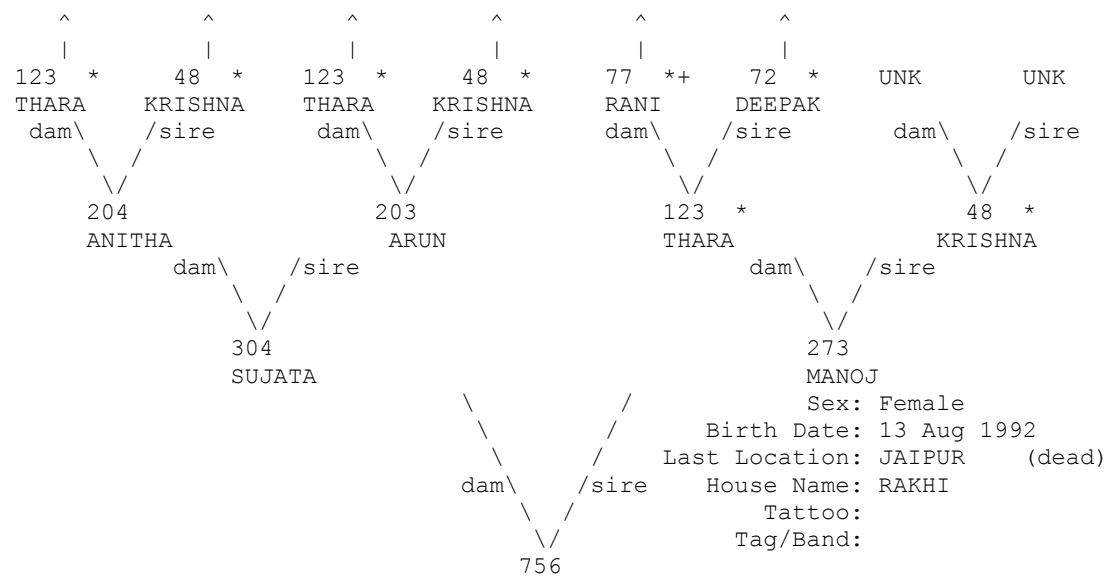

+ Wild-caught... * Appear more than once...
 ^ Pedigree continues beyond top of page...

=====
 Taxon Name: PANTHERA TIGRIS Studbook Number: 757
 =====

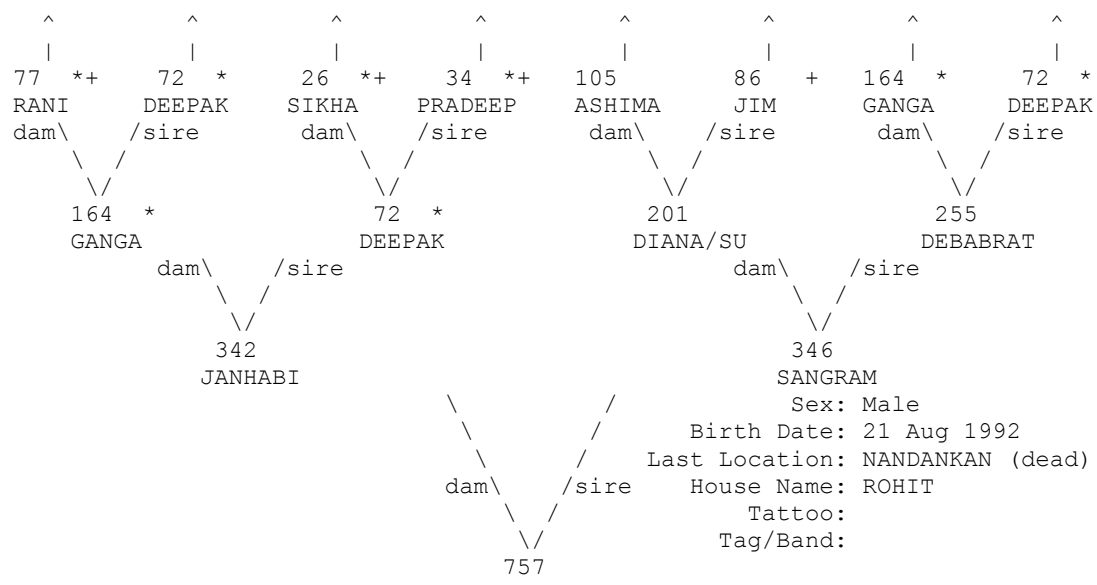

+ Wild-caught... * Appear more than once...
 ^ Pedigree continues beyond top of page...

=====
 Taxon Name: PANTHERA TIGRIS Studbook Number: 758
 =====

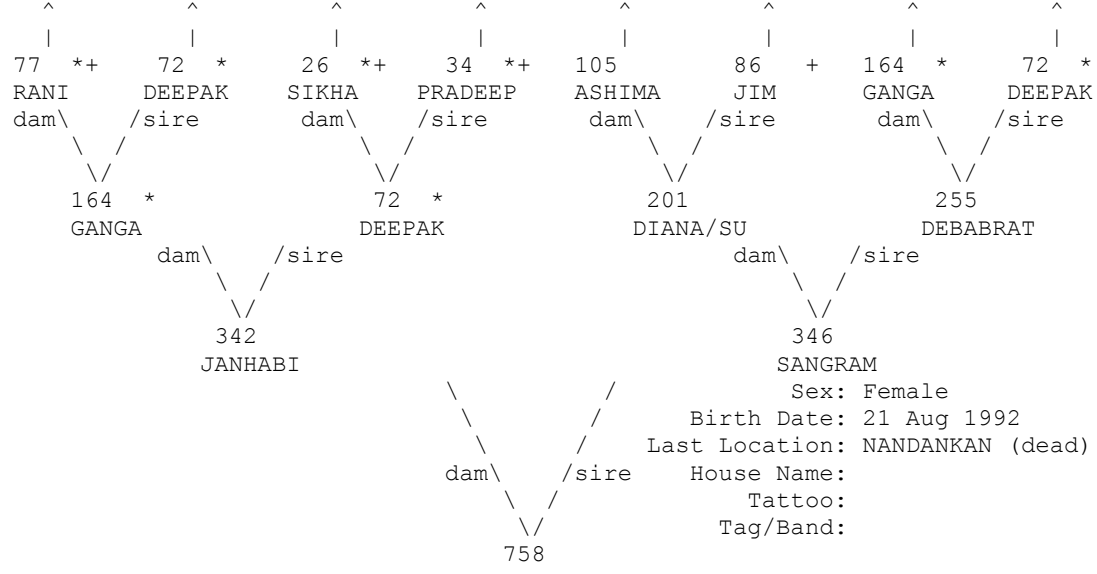

+ Wild-caught... * Appear more than once...
 ^ Pedigree continues beyond top of page...

=====
 Taxon Name: PANTHERA TIGRIS Studbook Number: 759
 =====

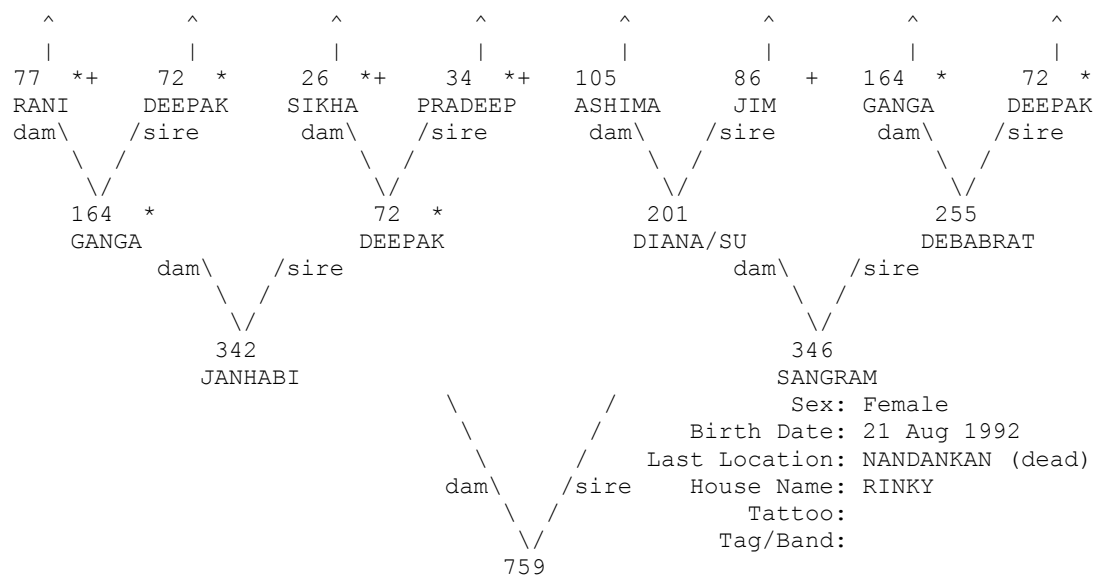

+ Wild-caught... * Appear more than once...
 ^ Pedigree continues beyond top of page...

=====
 Taxon Name: PANTHERA TIGRIS Studbook Number: 760
 =====

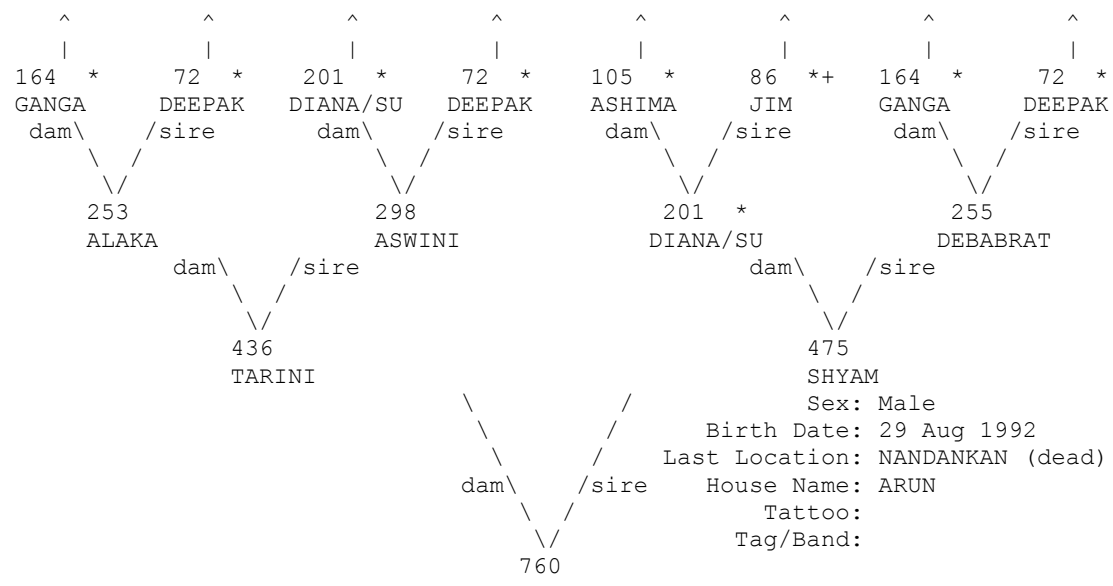

+ Wild-caught... * Appear more than once...
 ^ Pedigree continues beyond top of page...

=====
 Taxon Name: PANTHERA TIGRIS Studbook Number: 761
 =====

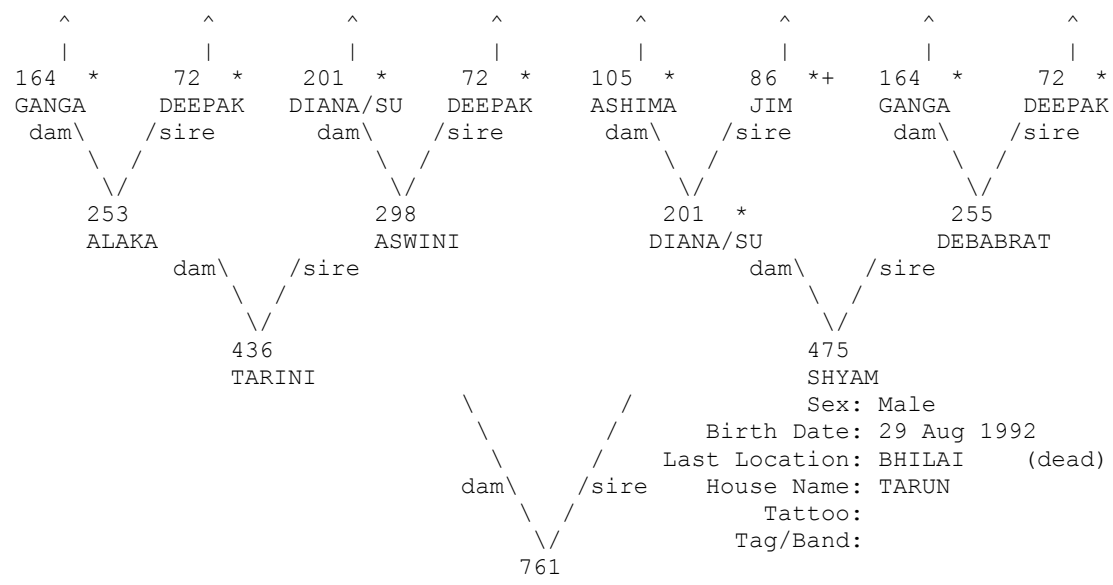

+ Wild-caught... * Appear more than once...
 ^ Pedigree continues beyond top of page...

=====
 Taxon Name: PANTHERA TIGRIS Studbook Number: 762
 =====

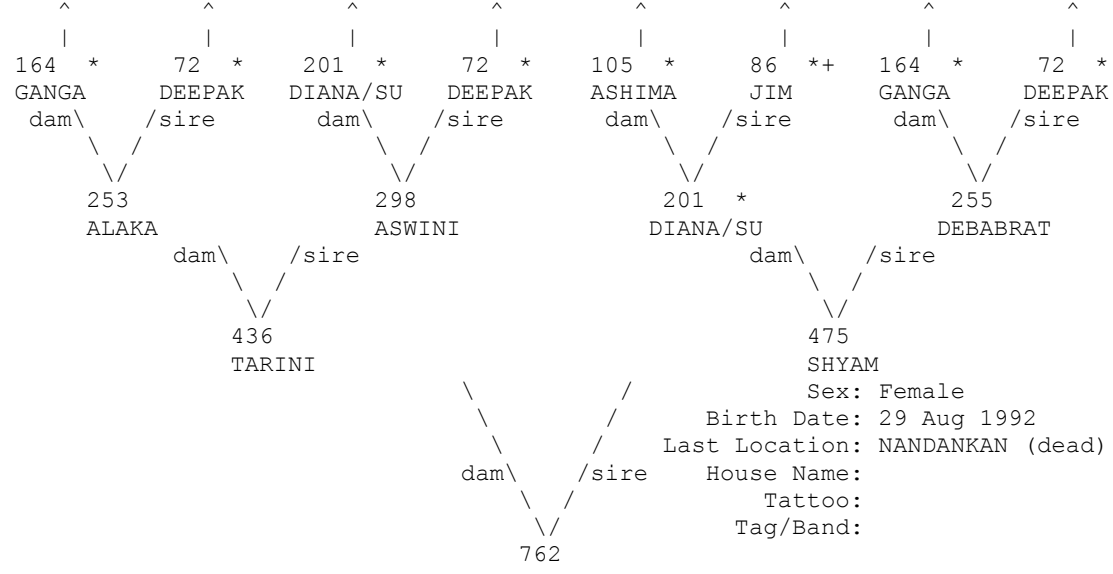

+ Wild-caught... * Appear more than once...
 ^ Pedigree continues beyond top of page...

=====
 Taxon Name: PANTHERA TIGRIS Studbook Number: 763
 =====

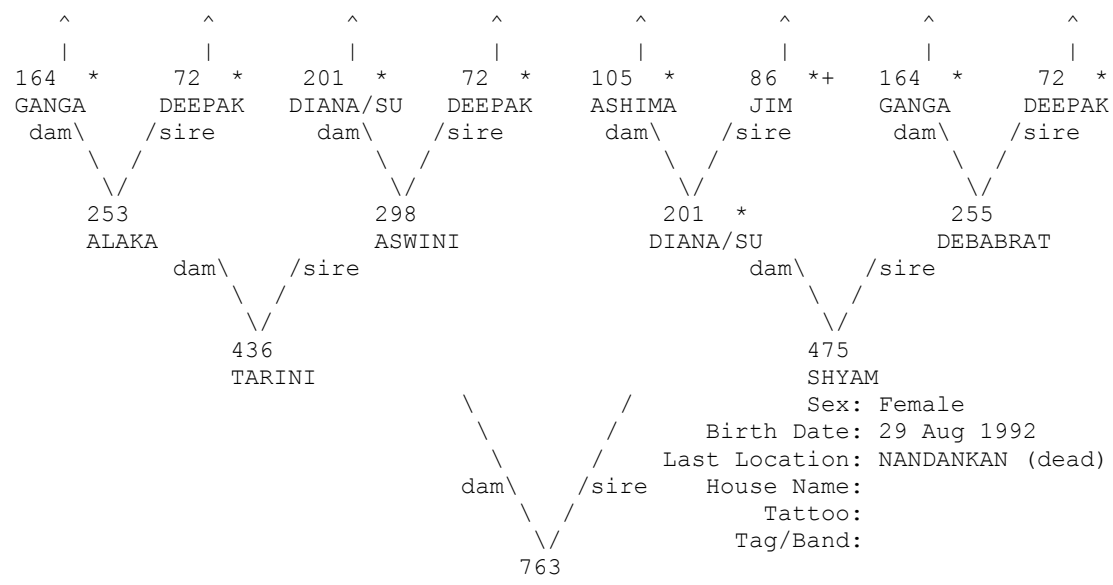

+ Wild-caught... * Appear more than once...
 ^ Pedigree continues beyond top of page...

=====
 Taxon Name: PANTHERA TIGRIS Studbook Number: 764
 =====

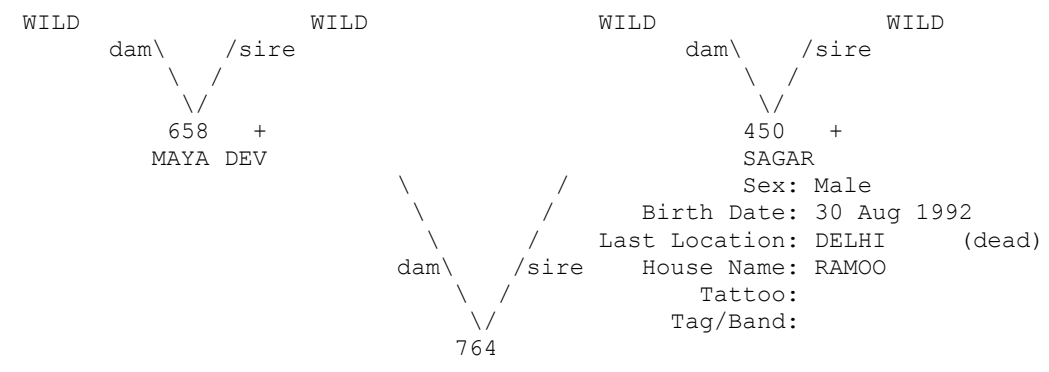

+ Wild-caught...

=====
 Taxon Name: PANTHERA TIGRIS Studbook Number: 765
 =====

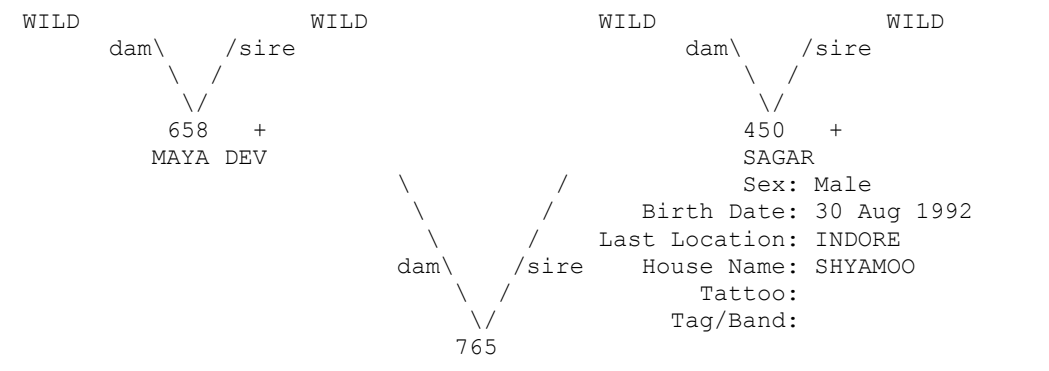

+ Wild-caught...

=====
 Taxon Name: PANTHERA TIGRIS Studbook Number: 766
 =====

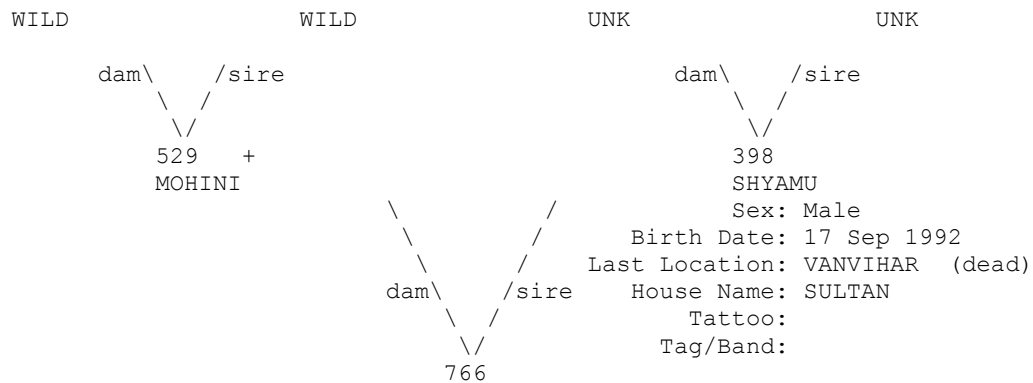

+ Wild-caught...

=====
 Taxon Name: PANTHERA TIGRIS Studbook Number: 767
 =====

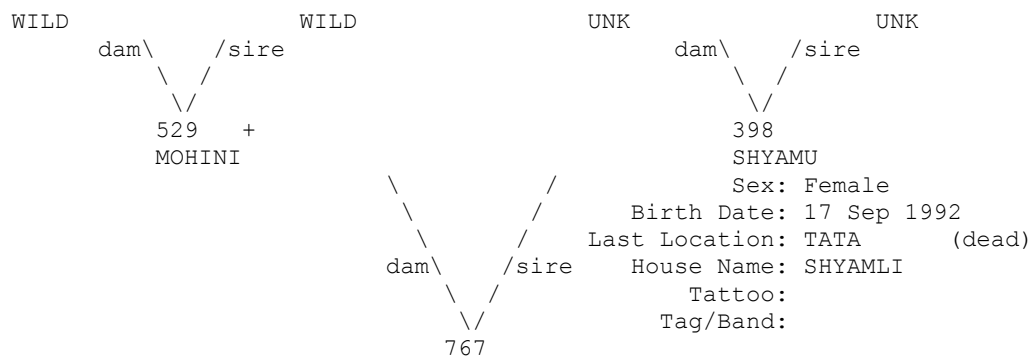

+ Wild-caught...

=====
 Taxon Name: PANTHERA TIGRIS Studbook Number: 768
 =====

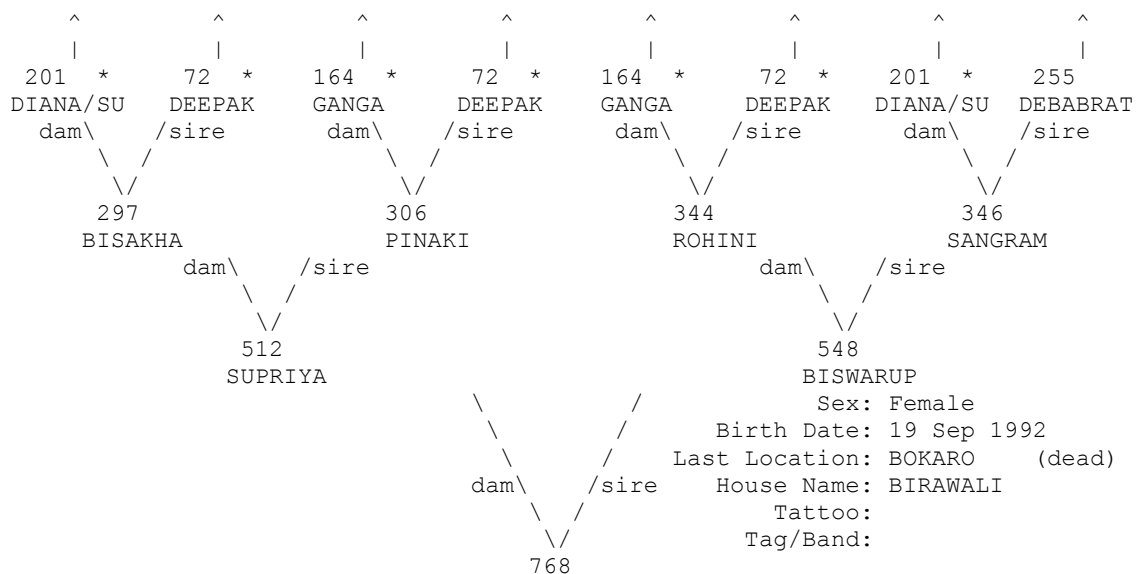

* Appear more than once...

^ Pedigree continues beyond top of page...

=====
 Taxon Name: PANTHERA TIGRIS Studbook Number: 769
 =====

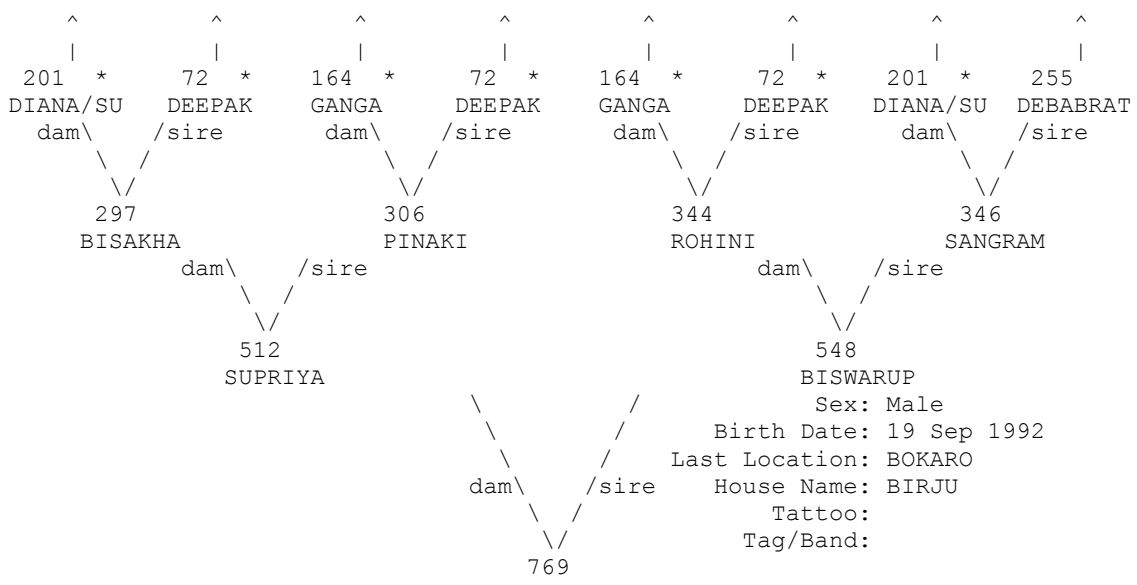

* Appear more than once...
 ^ Pedigree continues beyond top of page...

=====
 Taxon Name: PANTHERA TIGRIS Studbook Number: 770
 =====

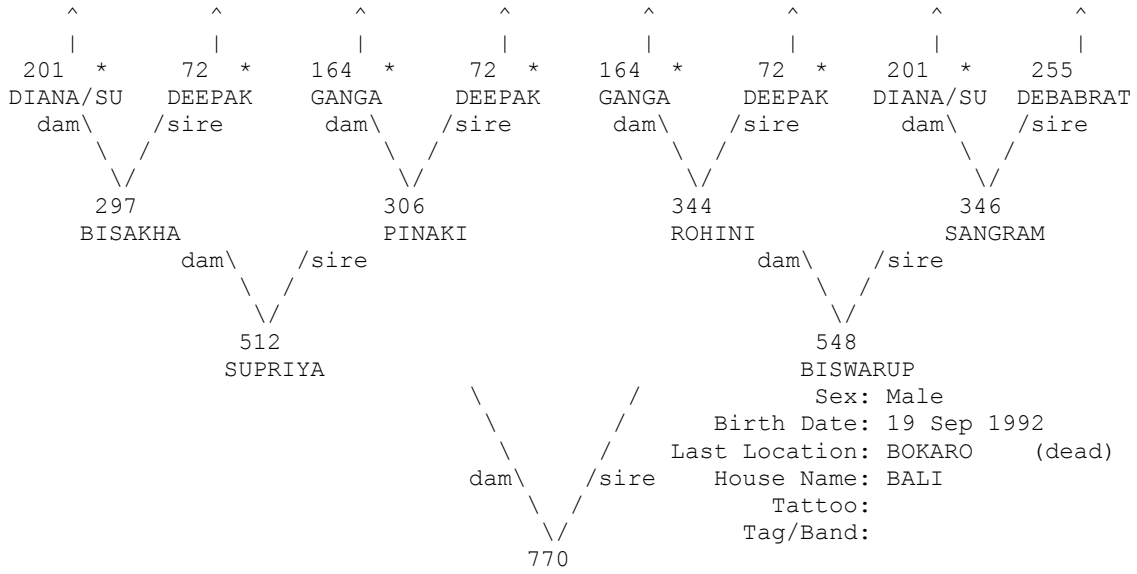

* Appear more than once...
 ^ Pedigree continues beyond top of page...

=====
 Taxon Name: PANTHERA TIGRIS Studbook Number: 771
 =====

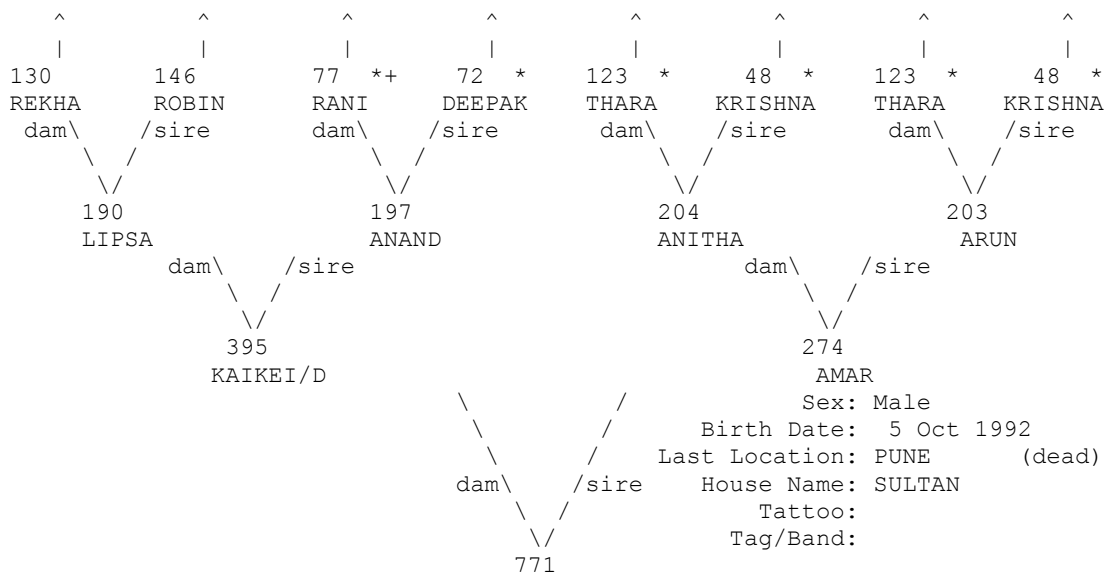

+ Wild-caught... * Appear more than once...
 ^ Pedigree continues beyond top of page...

=====
 Taxon Name: PANTHERA TIGRIS Studbook Number: 772
 =====

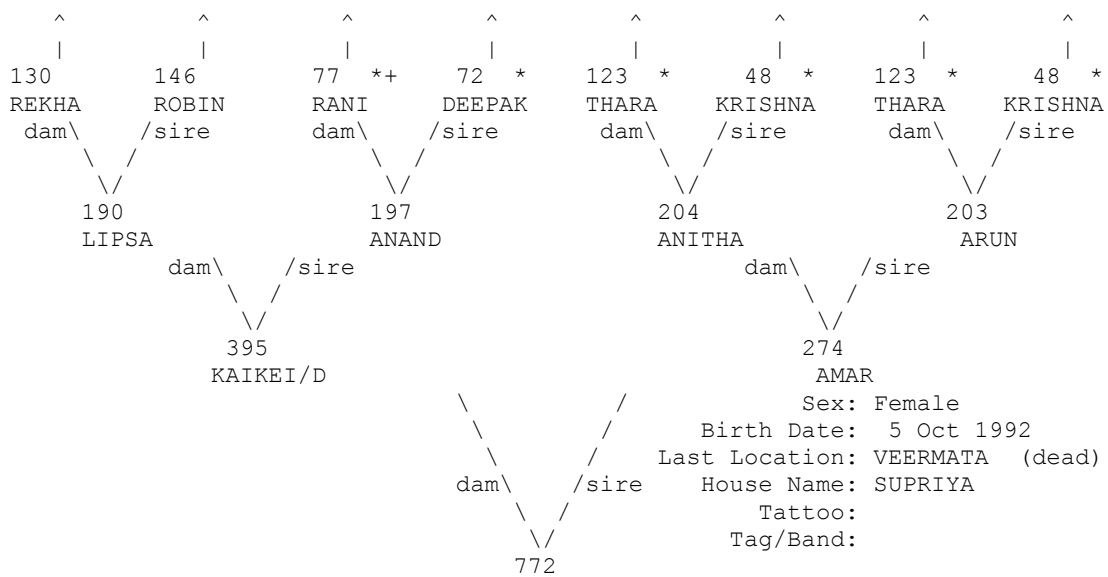

+ Wild-caught... * Appear more than once...
 ^ Pedigree continues beyond top of page...

=====
 Taxon Name: PANTHERA TIGRIS Studbook Number: 773
 =====

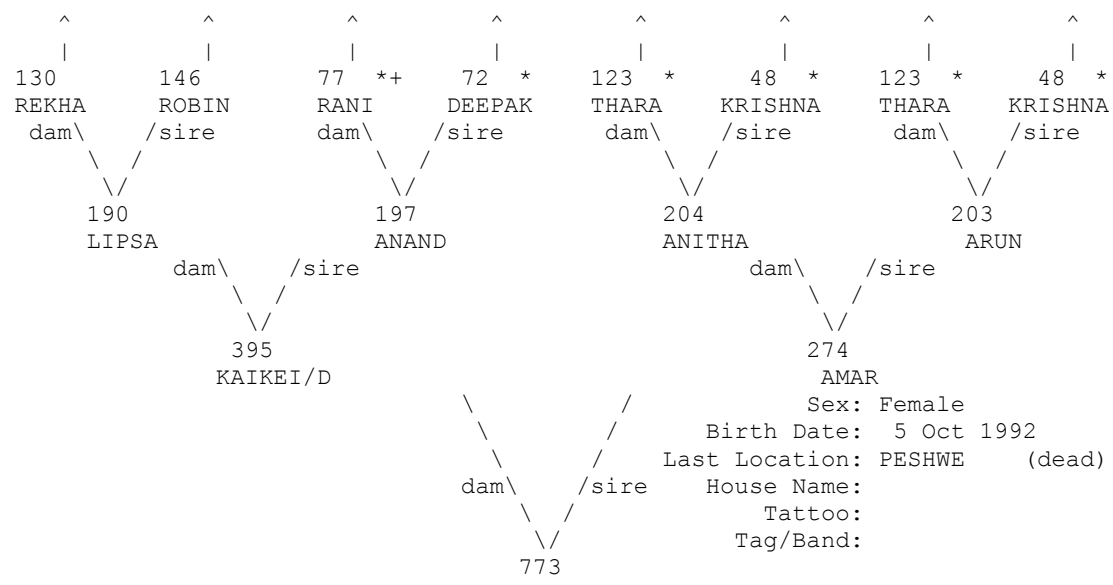

+ Wild-caught... * Appear more than once...
 ^ Pedigree continues beyond top of page...

=====
 Taxon Name: PANTHERA TIGRIS Studbook Number: 774
 =====

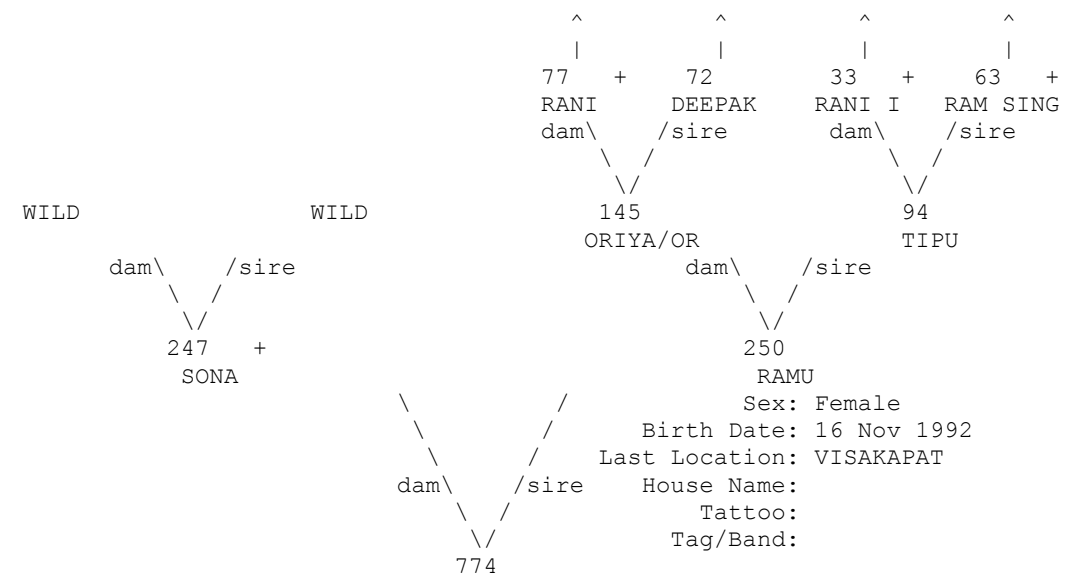

+ Wild-caught...
 ^ Pedigree continues beyond top of page...

=====
 Taxon Name: PANTHERA TIGRIS Studbook Number: 775
 =====

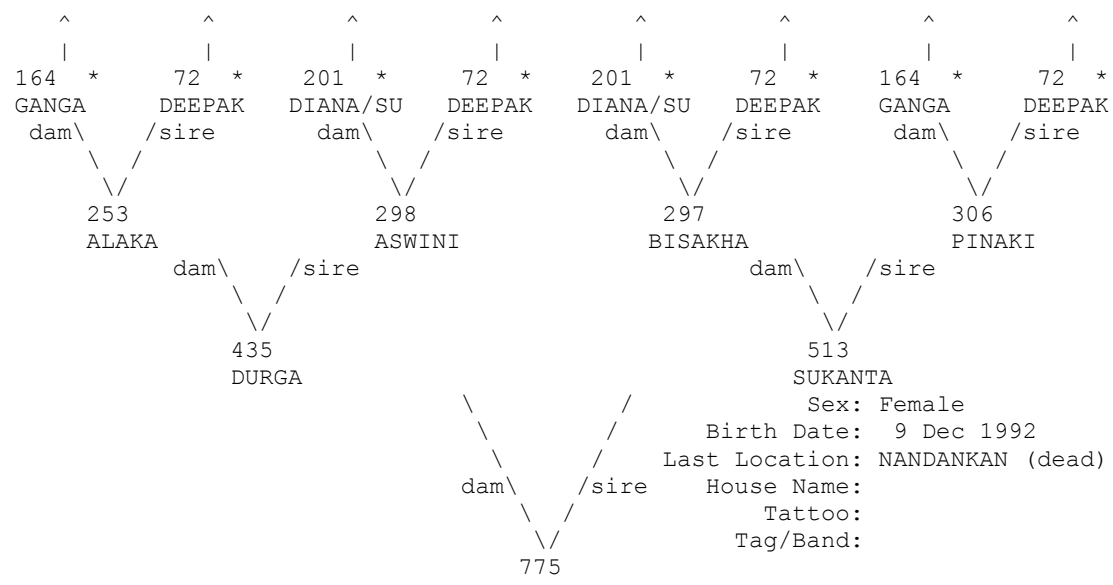

* Appear more than once...
 ^ Pedigree continues beyond top of page...

=====
 Taxon Name: PANTHERA TIGRIS Studbook Number: 776
 =====

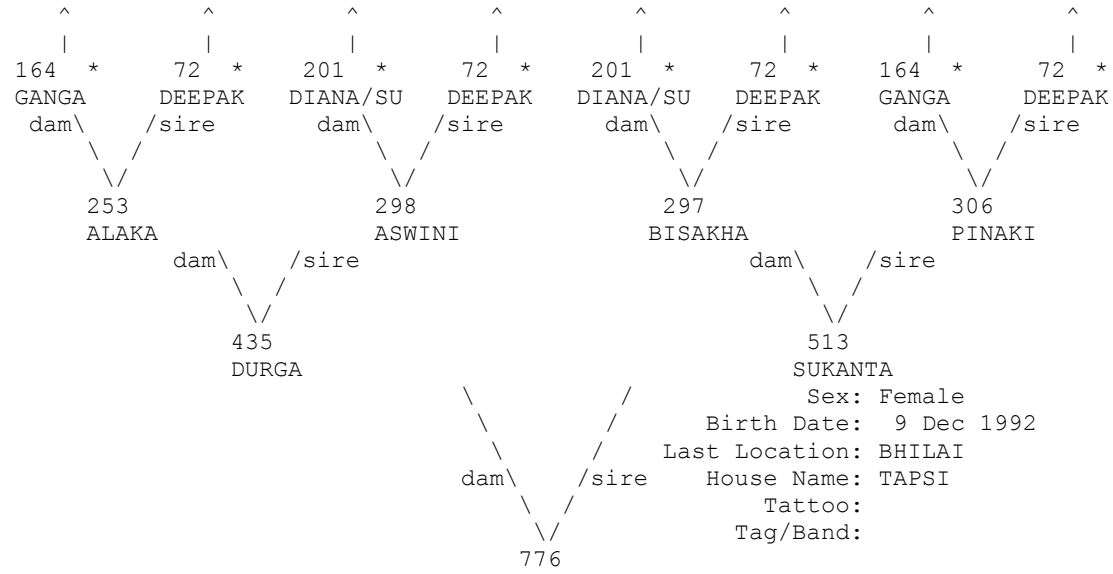

* Appear more than once...
 ^ Pedigree continues beyond top of page...

=====
 Taxon Name: PANTHERA TIGRIS Studbook Number: 780
 =====

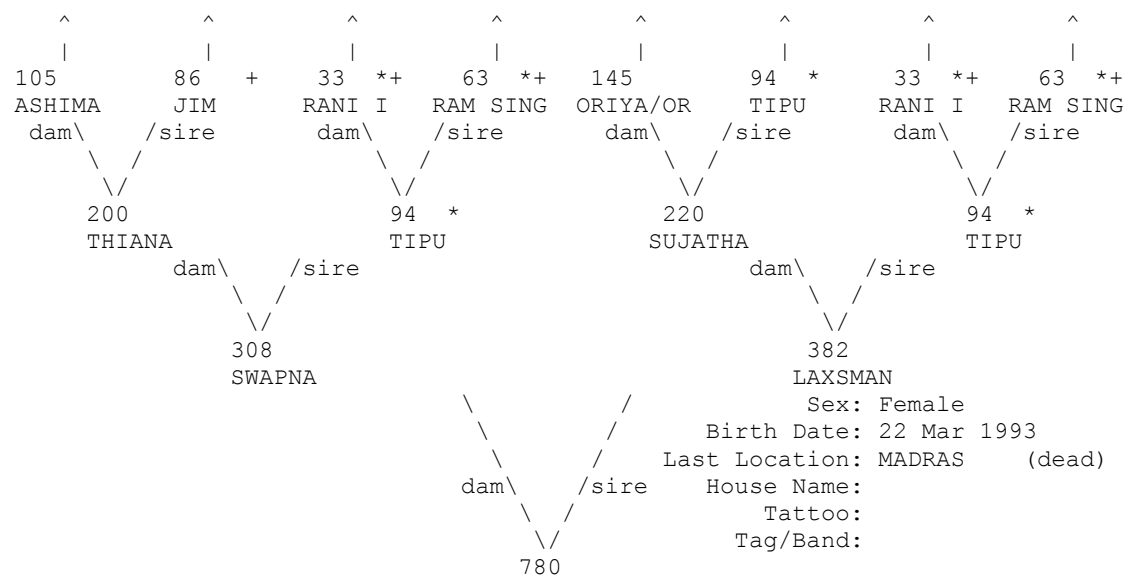

+ Wild-caught... * Appear more than once...
 ^ Pedigree continues beyond top of page...

=====
 Taxon Name: PANTHERA TIGRIS Studbook Number: 781
 =====

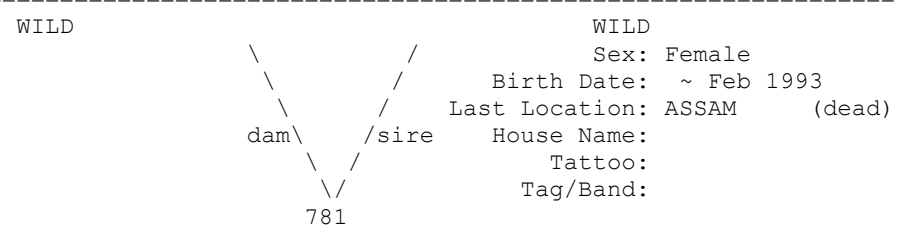

=====
 Taxon Name: PANTHERA TIGRIS Studbook Number: 782
 =====

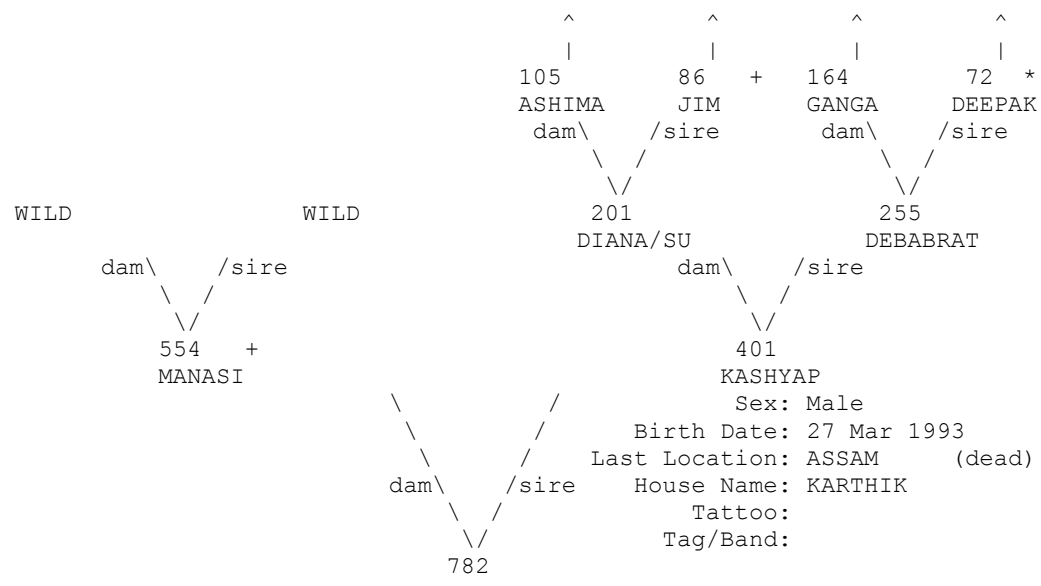

+ Wild-caught... * Appear more than once...
 ^ Pedigree continues beyond top of page...

=====
 Taxon Name: PANTHERA TIGRIS Studbook Number: 783
 =====

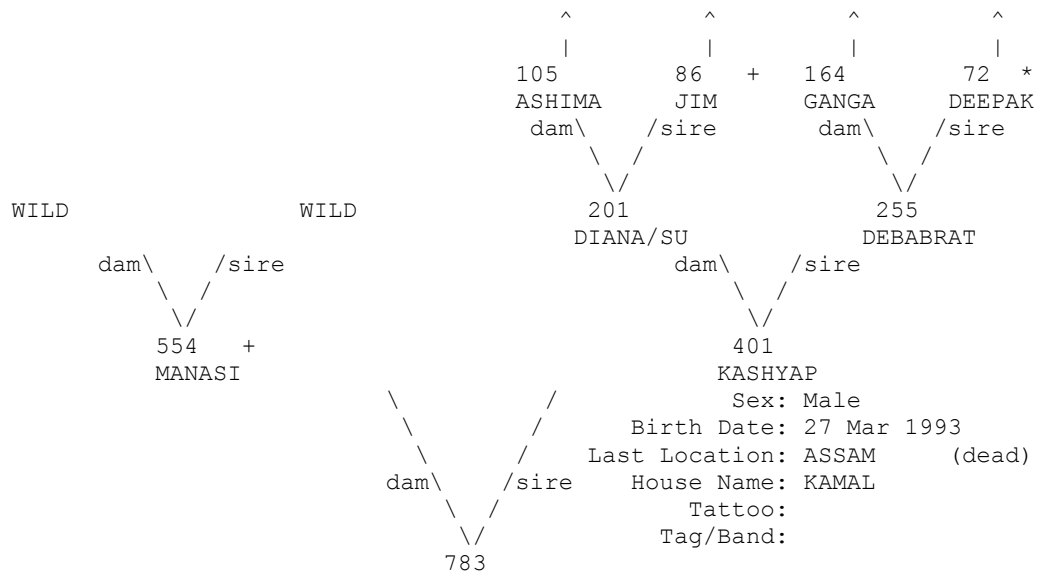

+ Wild-caught... * Appear more than once...
 ^ Pedigree continues beyond top of page...

=====
 Taxon Name: PANTHERA TIGRIS Studbook Number: 784
 =====

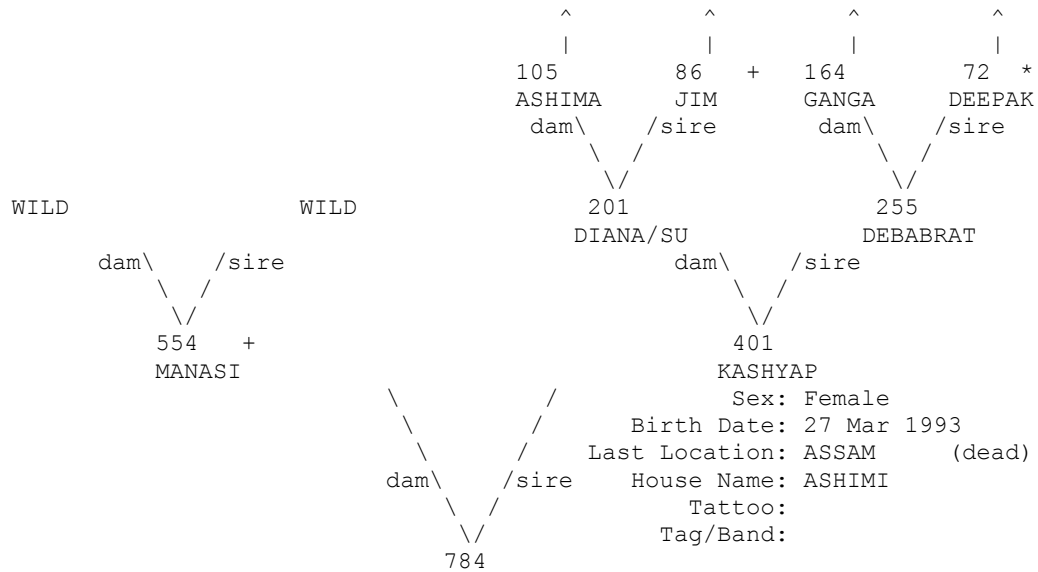

+ Wild-caught... * Appear more than once...
 ^ Pedigree continues beyond top of page...

=====
 Taxon Name: PANTHERA TIGRIS Studbook Number: 785
 =====

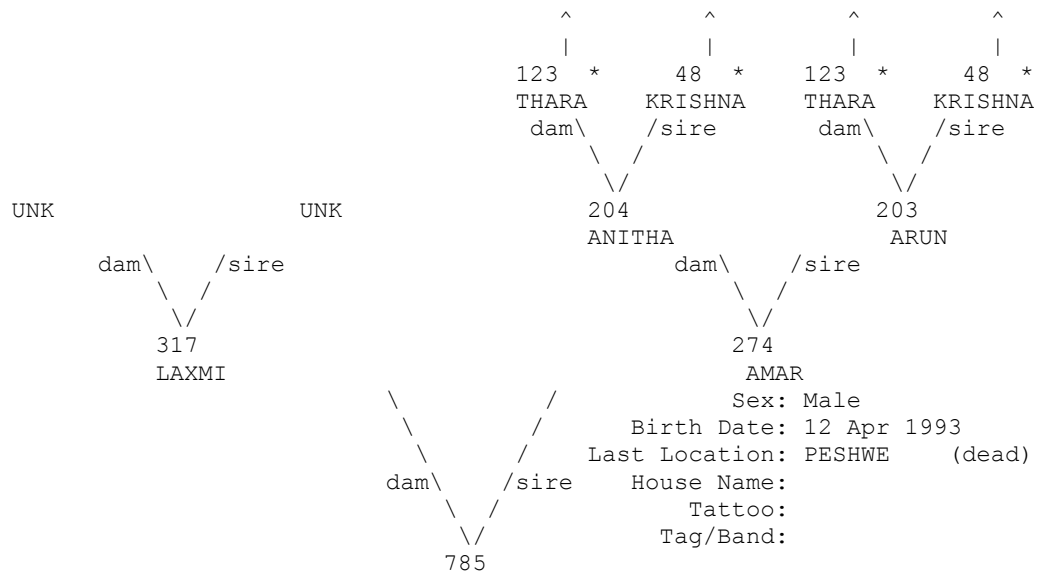

* Appear more than once...
 ^ Pedigree continues beyond top of page...

=====
 Taxon Name: PANTHERA TIGRIS Studbook Number: 786
 =====

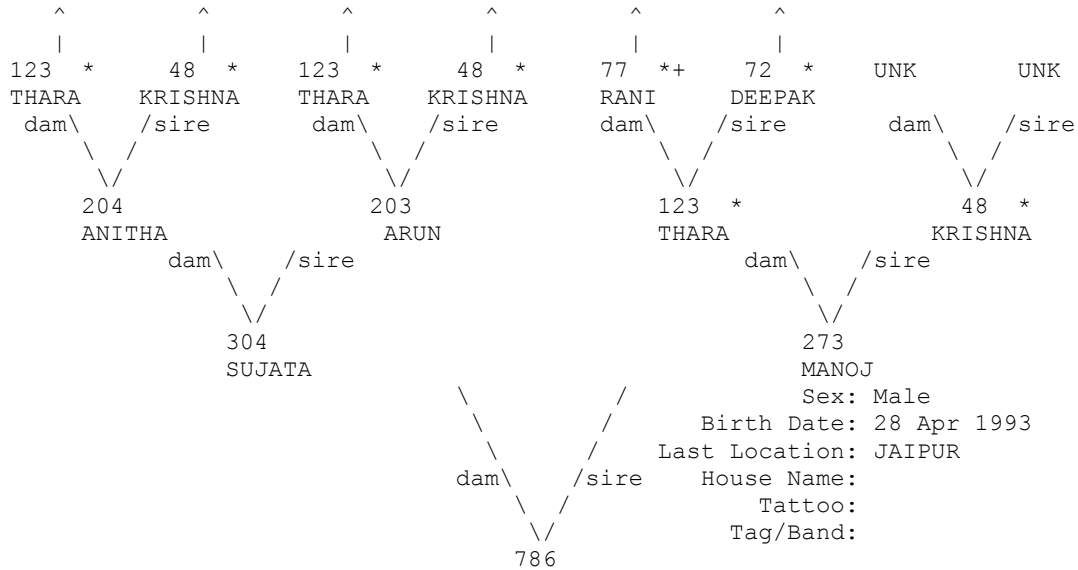

+ Wild-caught... * Appear more than once...
 ^ Pedigree continues beyond top of page...

=====
 Taxon Name: PANTHERA TIGRIS Studbook Number: 787
 =====

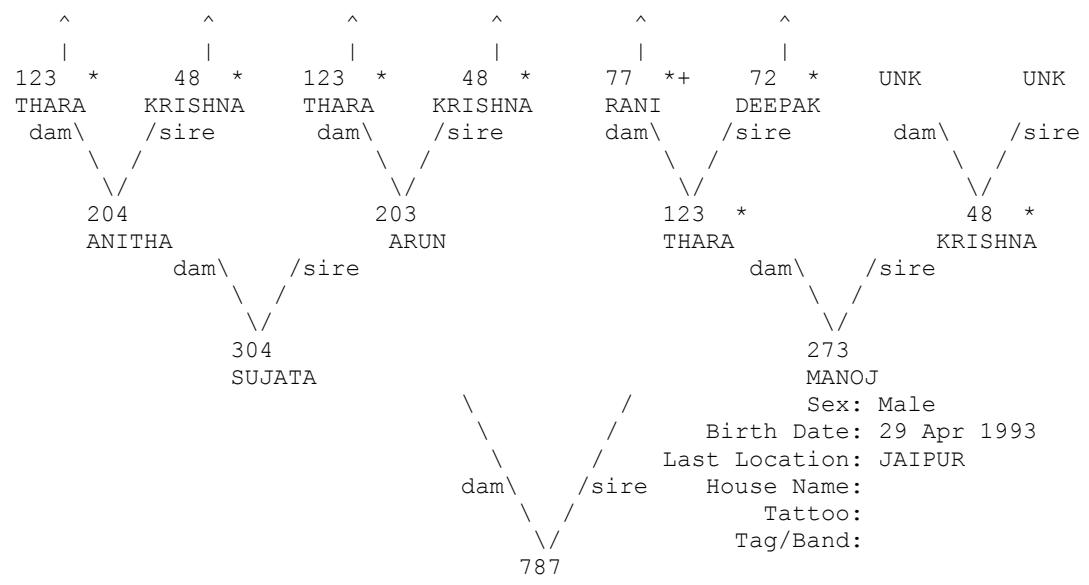

+ Wild-caught... * Appear more than once...
 ^ Pedigree continues beyond top of page...

=====
 Taxon Name: PANTHERA TIGRIS Studbook Number: 788
 =====

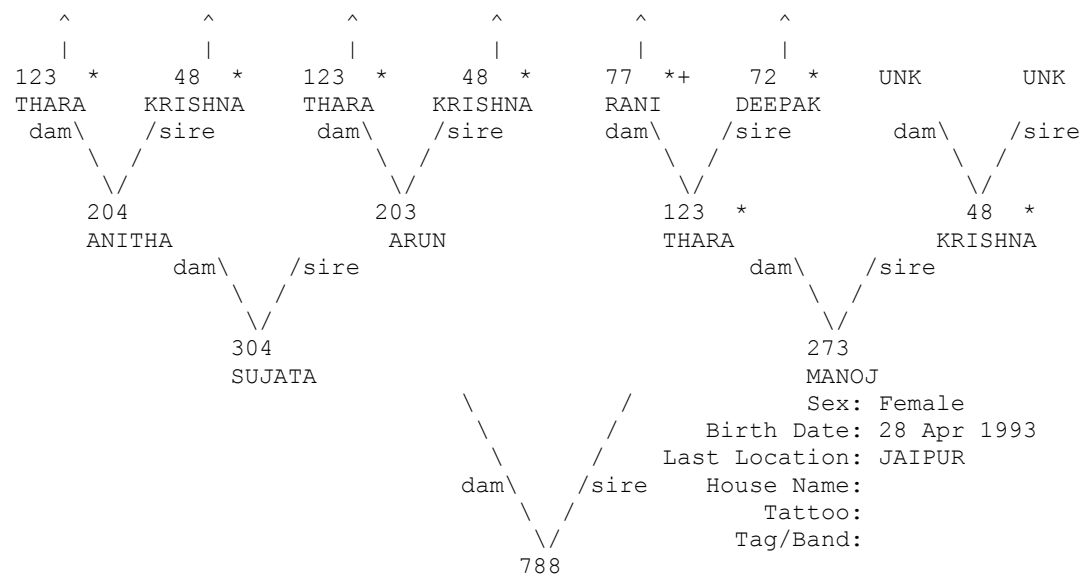

+ Wild-caught... * Appear more than once...
 ^ Pedigree continues beyond top of page...

=====
 Taxon Name: PANTHERA TIGRIS Studbook Number: 791
 =====

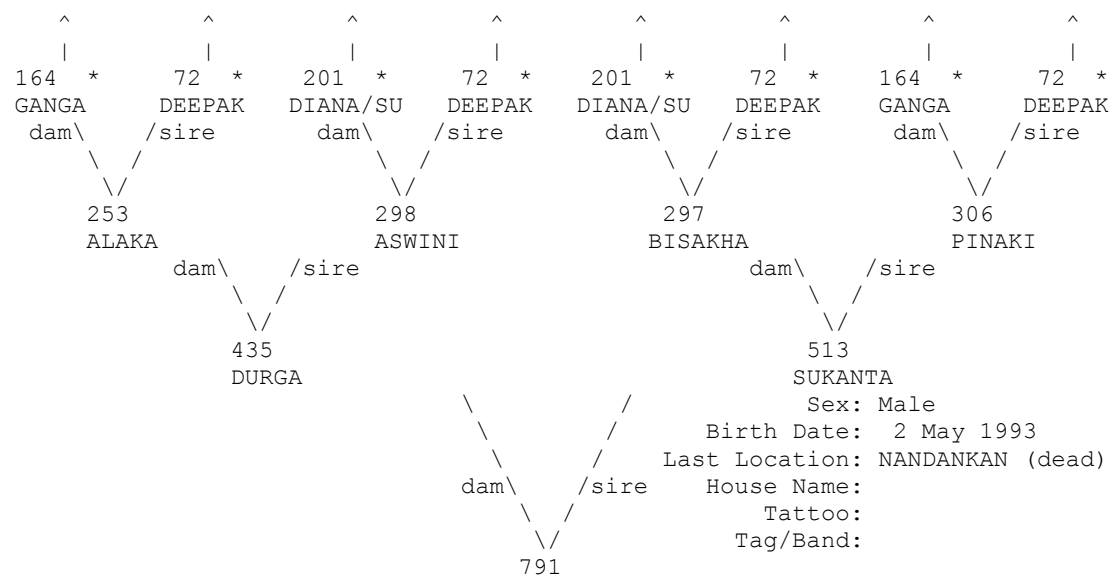

* Appear more than once...
 ^ Pedigree continues beyond top of page...

=====
 Taxon Name: PANTHERA TIGRIS Studbook Number: 792
 =====

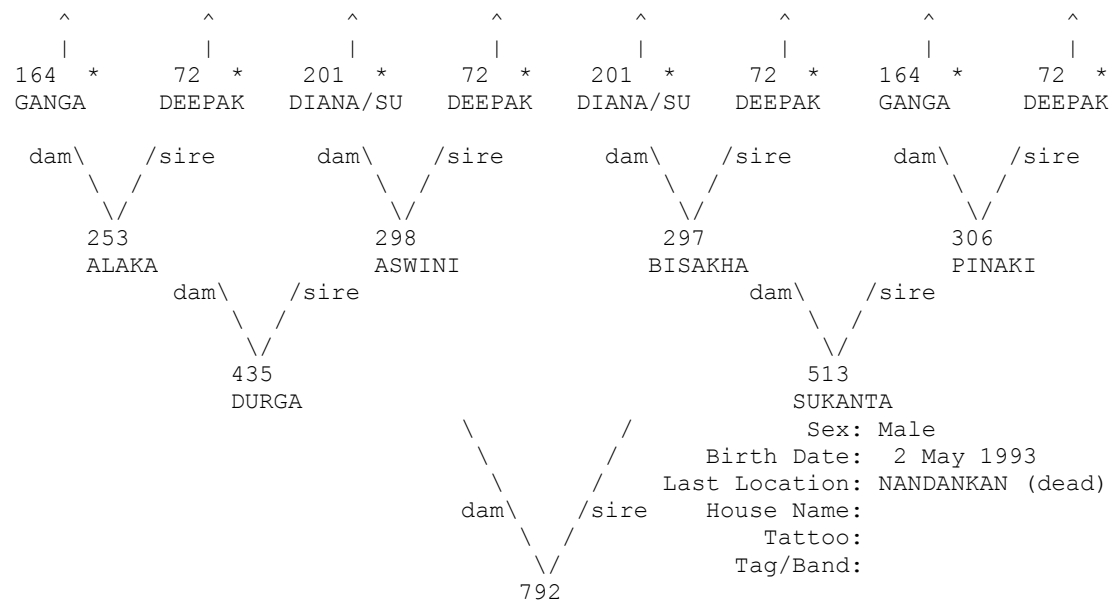

* Appear more than once...
 ^ Pedigree continues beyond top of page...

=====
 Taxon Name: PANTHERA TIGRIS Studbook Number: 793
 =====

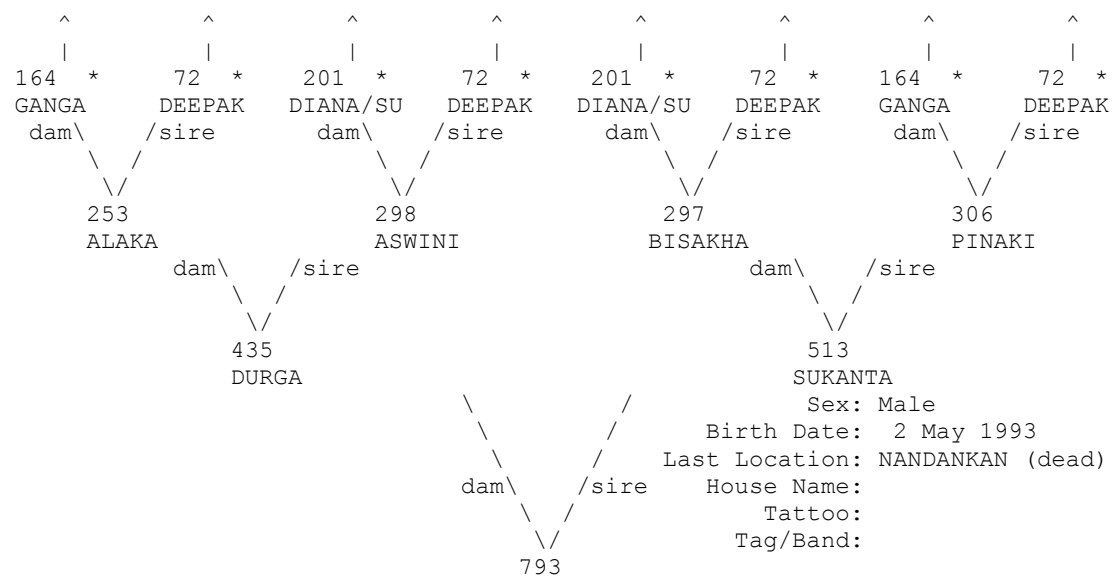

* Appear more than once...
 ^ Pedigree continues beyond top of page...

=====
 Taxon Name: PANTHERA TIGRIS Studbook Number: 794
 =====

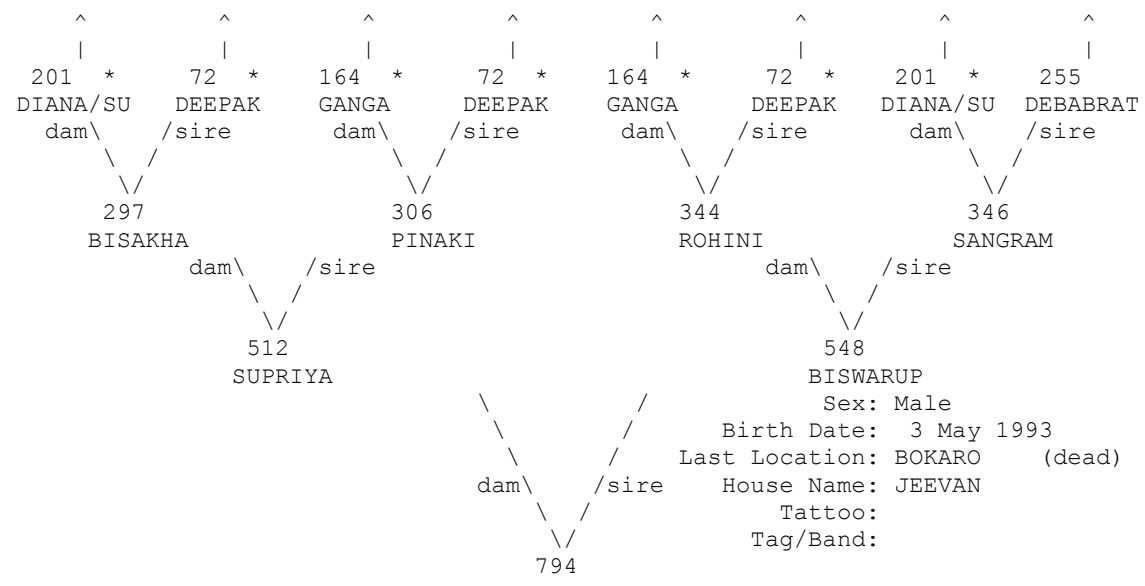

* Appear more than once...
 ^ Pedigree continues beyond top of page...

=====
 Taxon Name: PANTHERA TIGRIS Studbook Number: 795
 =====

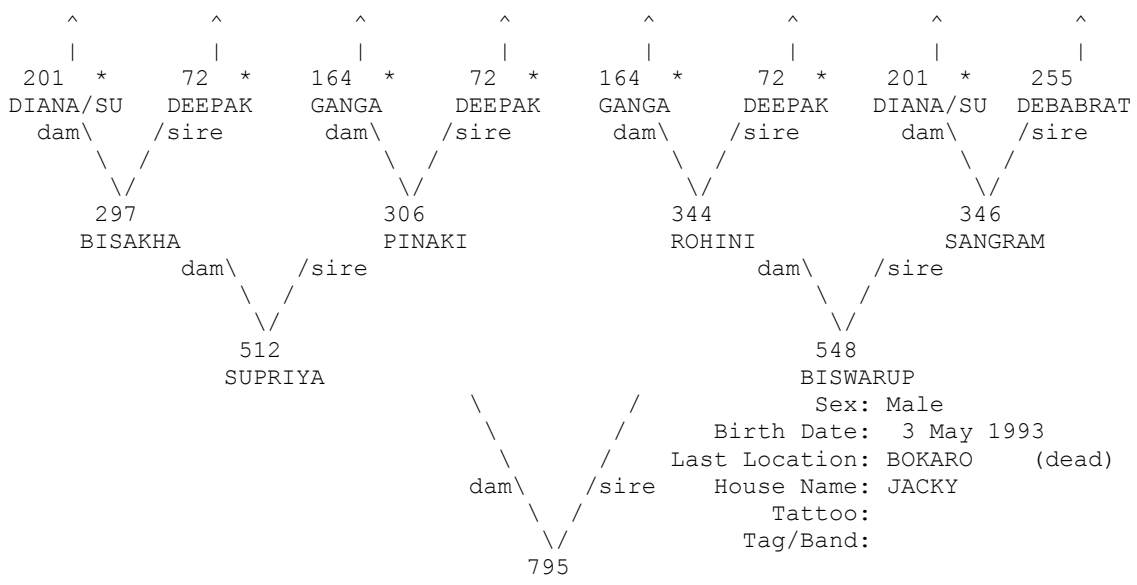

* Appear more than once...
 ^ Pedigree continues beyond top of page...

=====
 Taxon Name: PANTHERA TIGRIS Studbook Number: 796
 =====

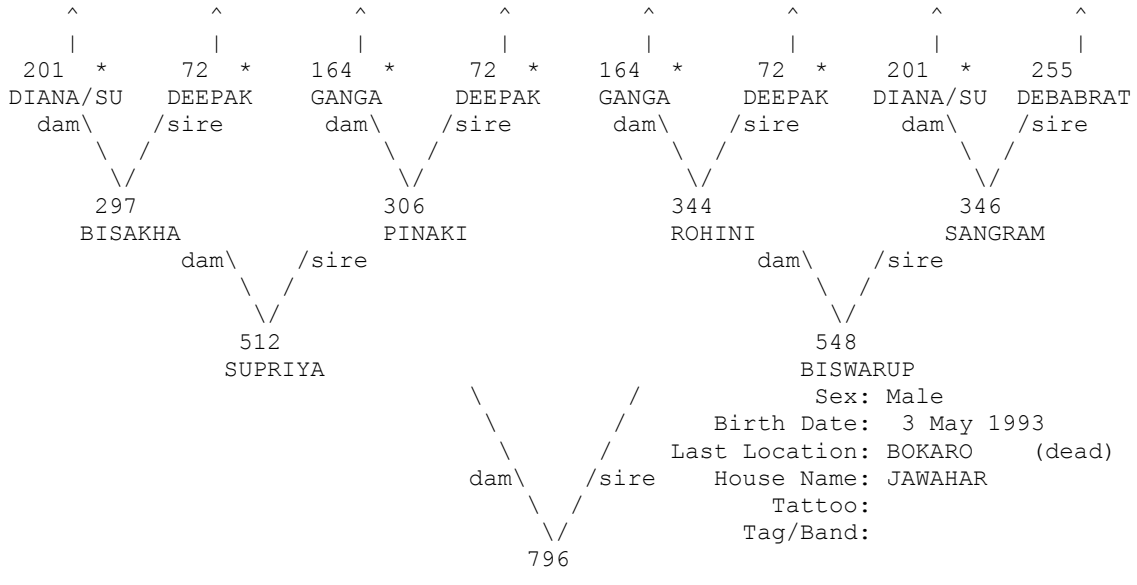

* Appear more than once...
 ^ Pedigree continues beyond top of page...

=====
 Taxon Name: PANTHERA TIGRIS Studbook Number: 797
 =====

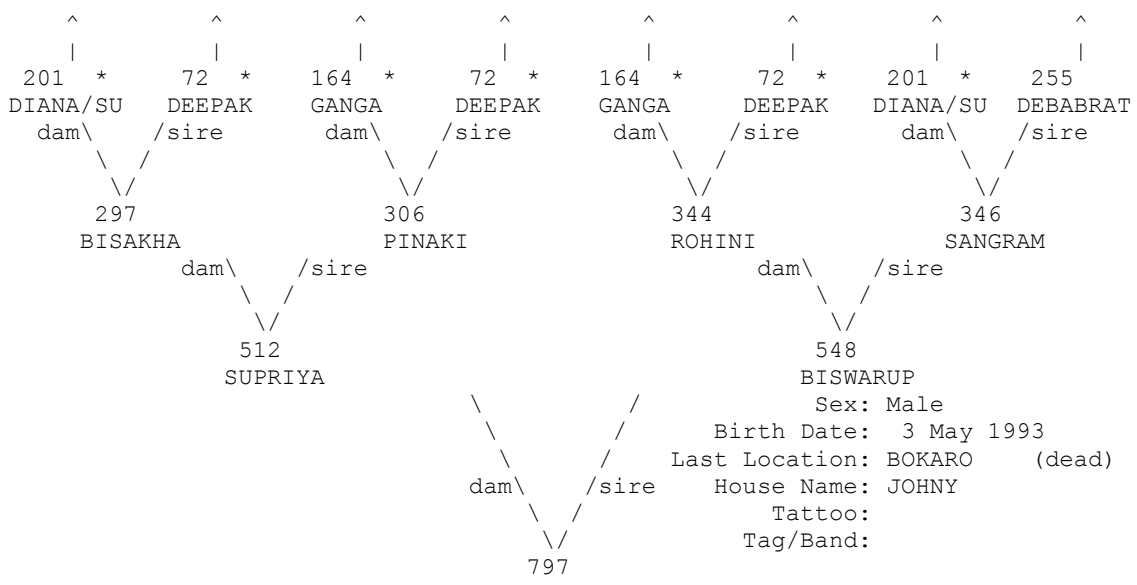

* Appear more than once...
 ^ Pedigree continues beyond top of page...

=====
 Taxon Name: PANTHERA TIGRIS Studbook Number: 798
 =====

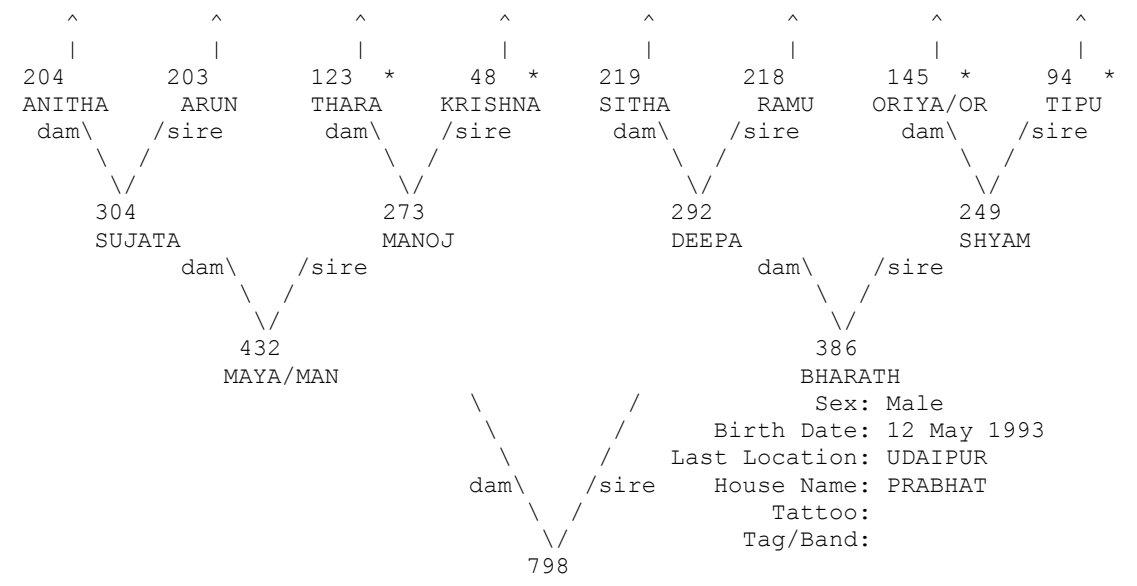

* Appear more than once...
 ^ Pedigree continues beyond top of page...

=====

Taxon Name: PANTHERA TIGRIS Studbook Number: 799

=====

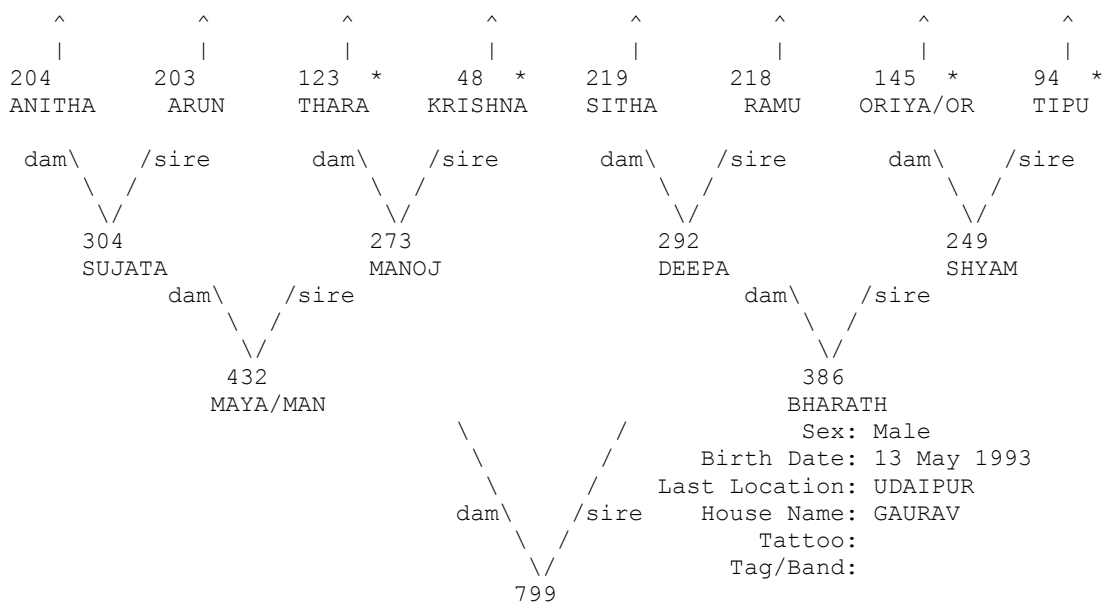

* Appear more than once...
 ^ Pedigree continues beyond top of page...

=====

Taxon Name: PANTHERA TIGRIS Studbook Number: 800

=====

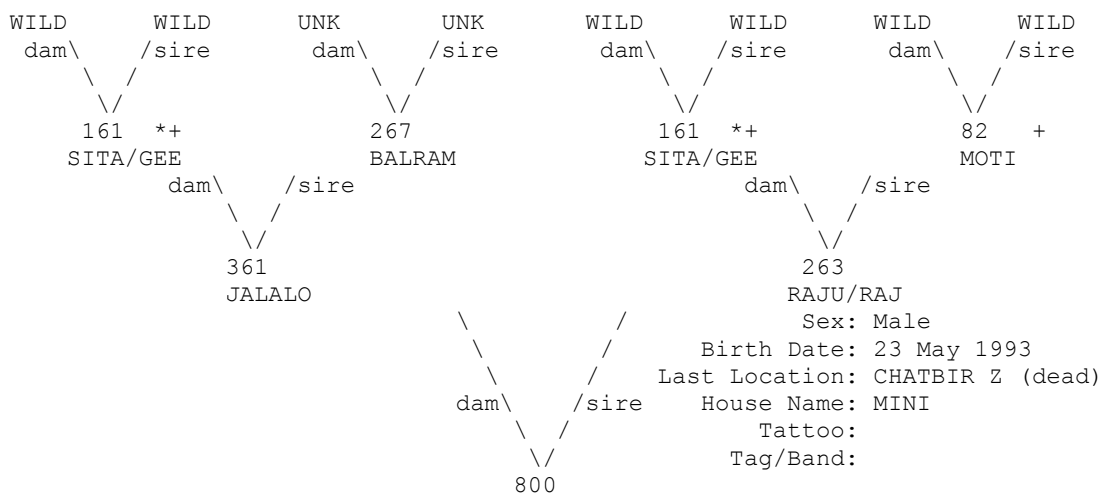

+ Wild-caught... * Appear more than once...

=====
 Taxon Name: PANTHERA TIGRIS Studbook Number: 801
 =====

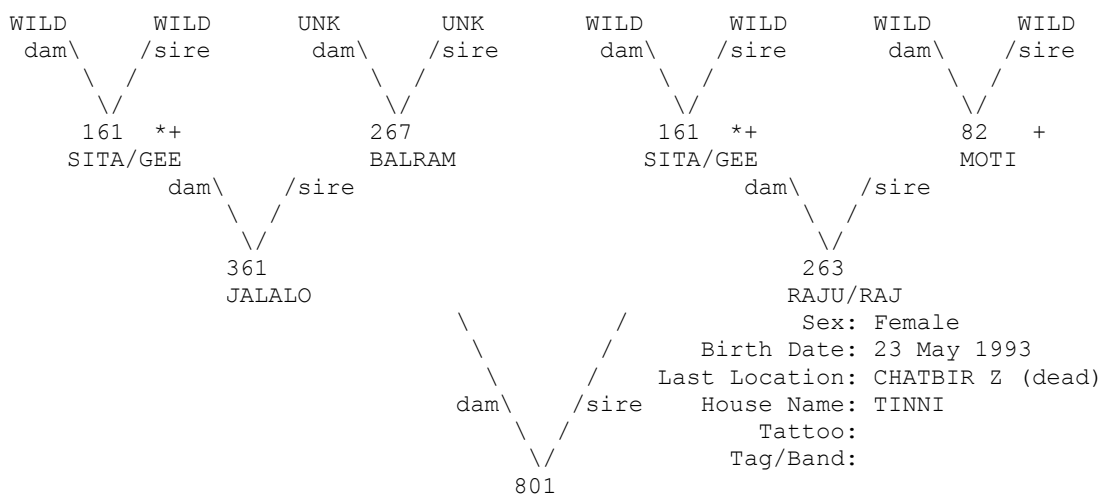

+ Wild-caught... * Appear more than once...

=====
 Taxon Name: PANTHERA TIGRIS Studbook Number: 802
 =====

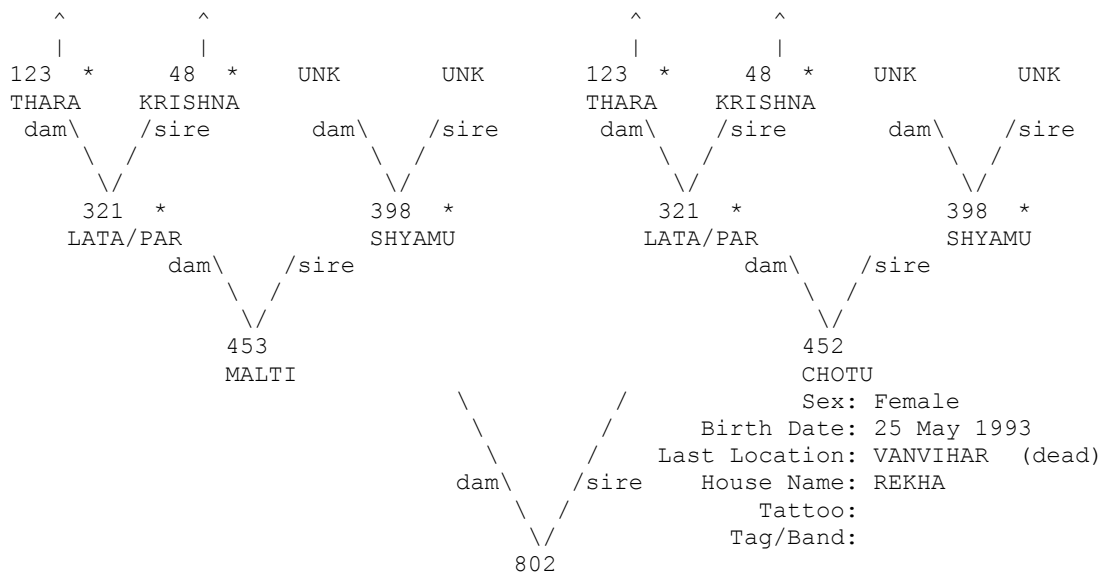

* Appear more than once...
 ^ Pedigree continues beyond top of page...

=====
 Taxon Name: PANTHERA TIGRIS Studbook Number: 803
 =====

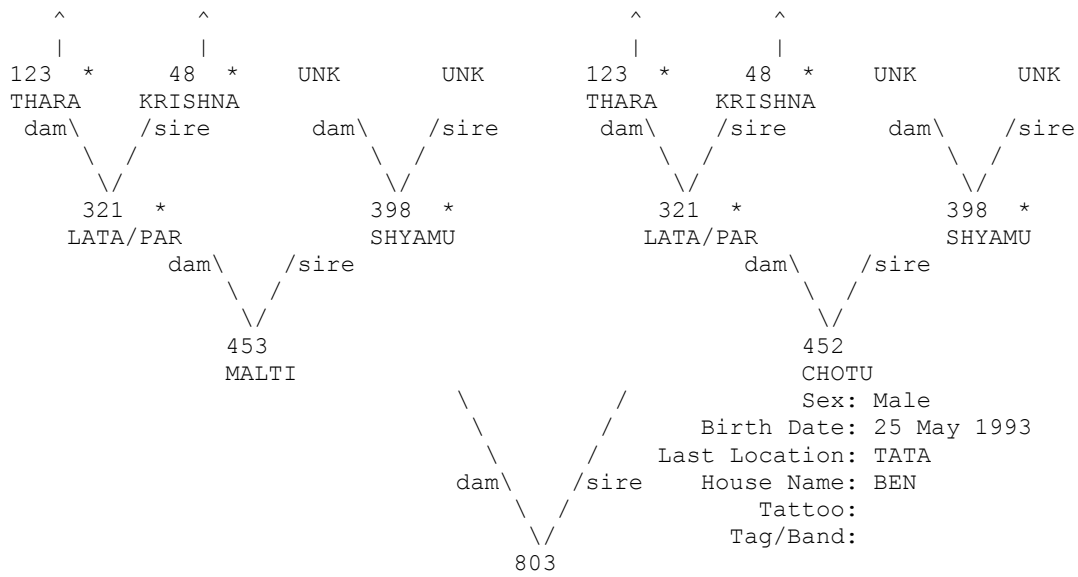

* Appear more than once...
 ^ Pedigree continues beyond top of page...

=====
 Taxon Name: PANTHERA TIGRIS Studbook Number: 804
 =====

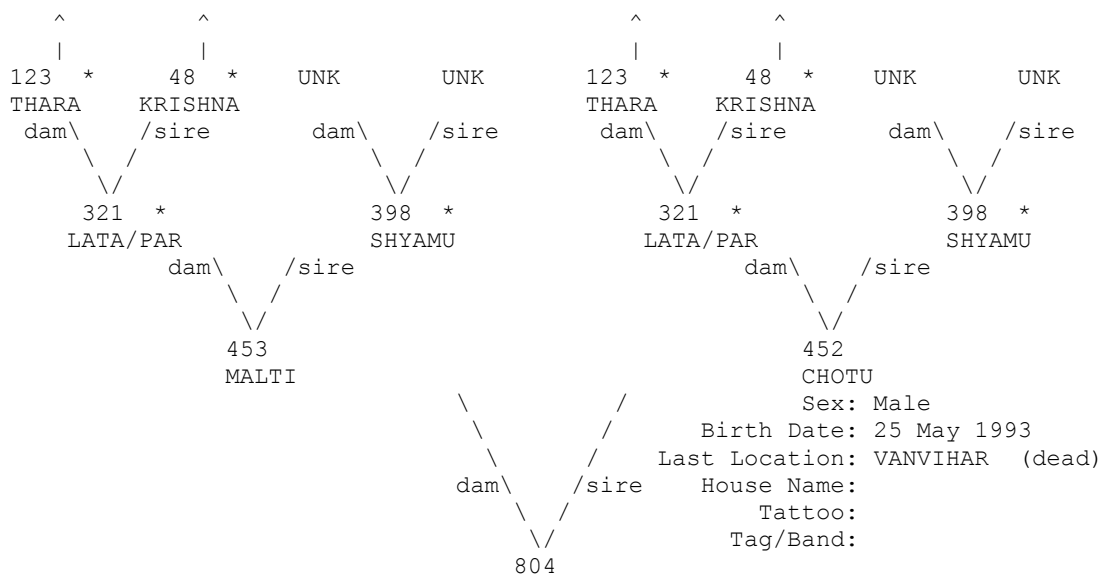

* Appear more than once...
 ^ Pedigree continues beyond top of page...

=====
 Taxon Name: PANTHERA TIGRIS Studbook Number: 809
 =====

UNK

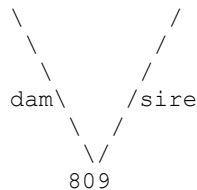

UNK
 Sex: Female
 Birth Date: ~ 1993
 Last Location: DELHI
 House Name: PRIYA
 Tattoo:
 Tag/Band:

=====
 Taxon Name: PANTHERA TIGRIS Studbook Number: 810
 =====

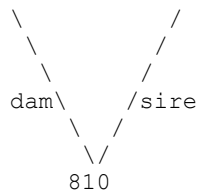
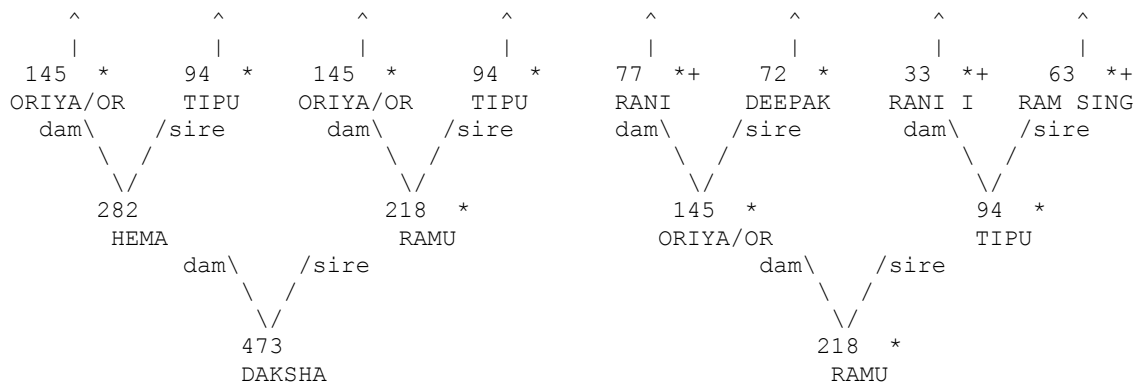

Sex: Male
 Birth Date: 16 Jun 1993
 Last Location: JUNAGADH (dead)
 House Name:
 Tattoo:
 Tag/Band:

+ Wild-caught... * Appear more than once...
 ^ Pedigree continues beyond top of page...

=====
 Taxon Name: PANTHERA TIGRIS Studbook Number: 811
 =====

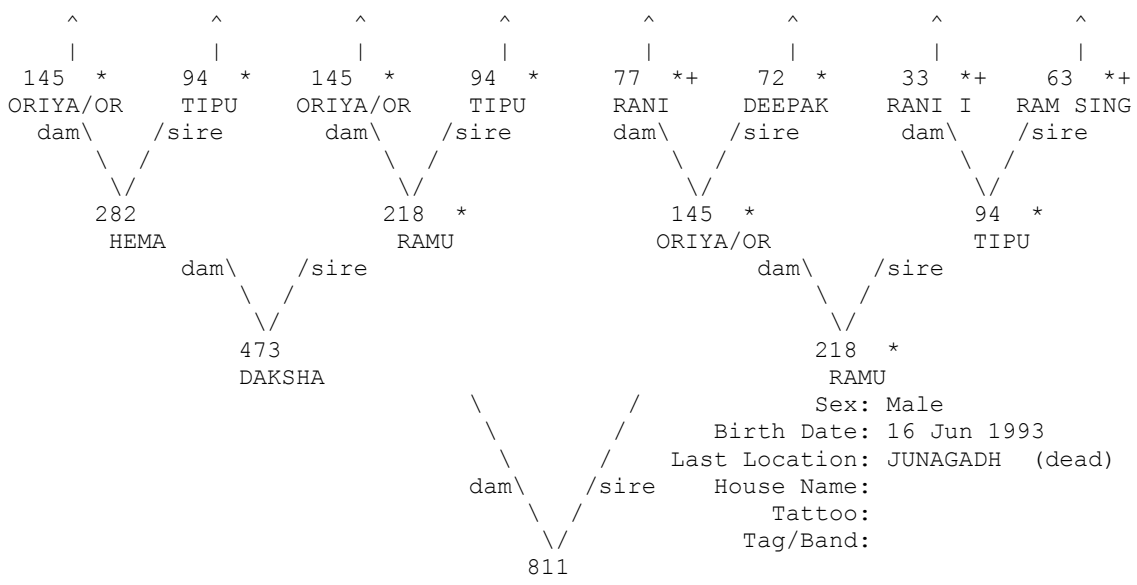

+ Wild-caught... * Appear more than once...
 ^ Pedigree continues beyond top of page...

=====
 Taxon Name: PANTHERA TIGRIS Studbook Number: 812
 =====

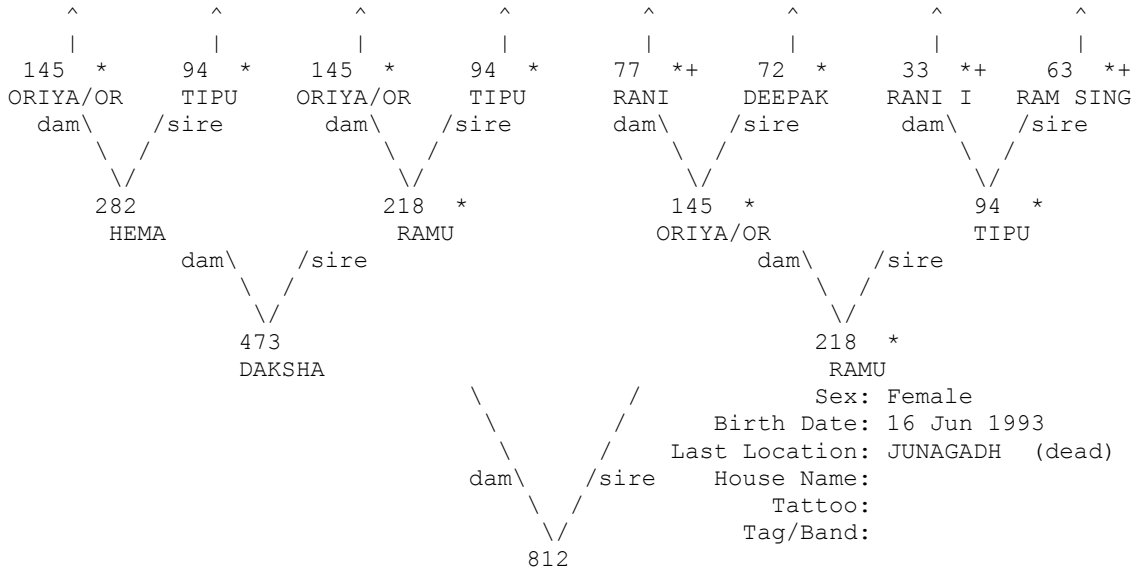

+ Wild-caught... * Appear more than once...
 ^ Pedigree continues beyond top of page...

=====
 Taxon Name: PANTHERA TIGRIS Studbook Number: 815
 =====

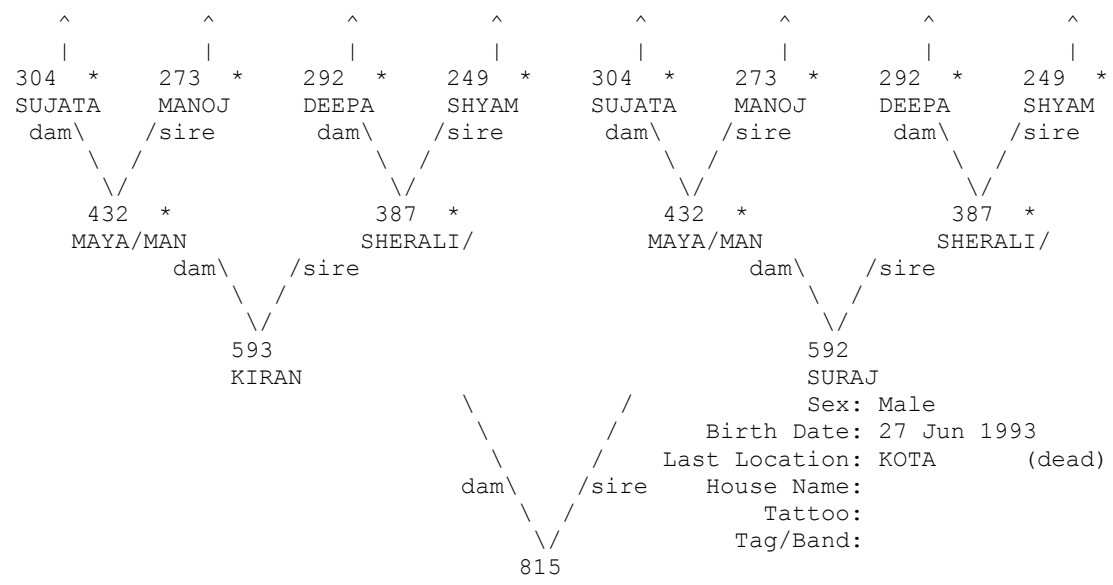

* Appear more than once...
 ^ Pedigree continues beyond top of page...

=====
 Taxon Name: PANTHERA TIGRIS Studbook Number: 816
 =====

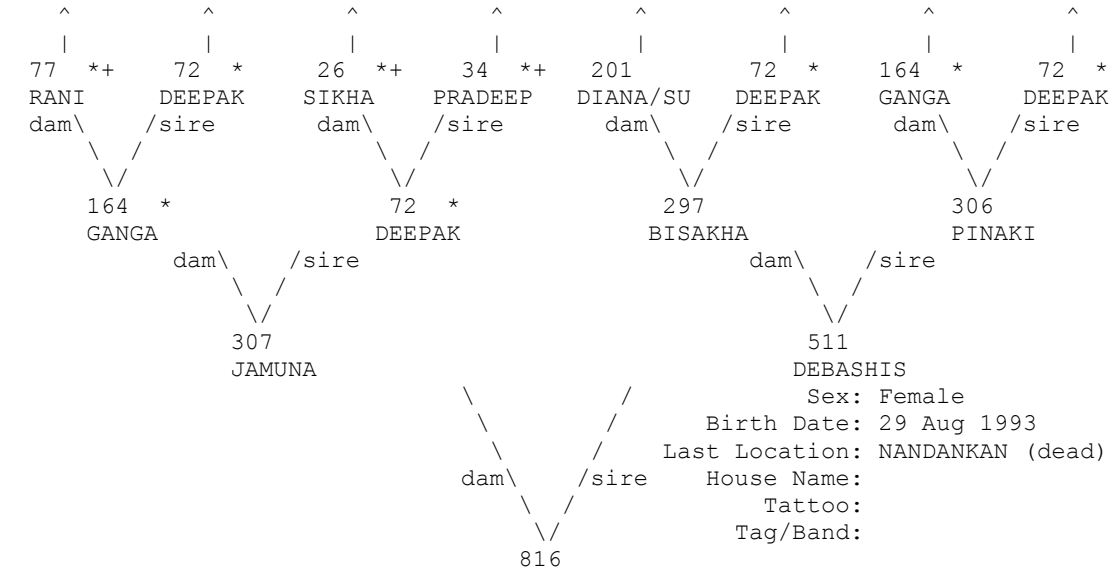

+ Wild-caught... * Appear more than once...
 ^ Pedigree continues beyond top of page...

=====
 Taxon Name: PANTHERA TIGRIS Studbook Number: 817
 =====

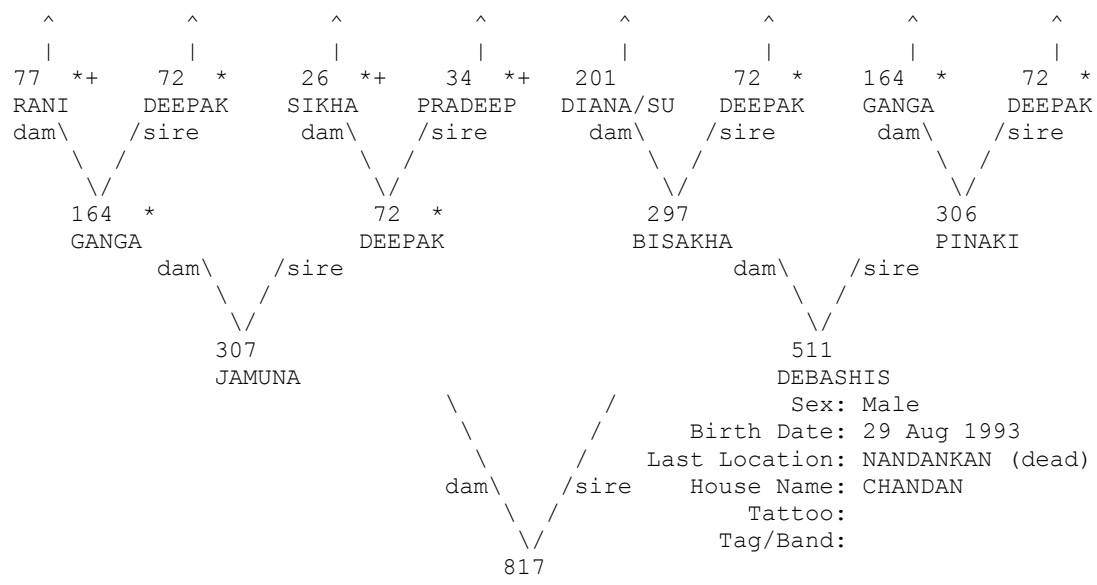

+ Wild-caught... * Appear more than once...
 ^ Pedigree continues beyond top of page...

=====
 Taxon Name: PANTHERA TIGRIS Studbook Number: 818
 =====

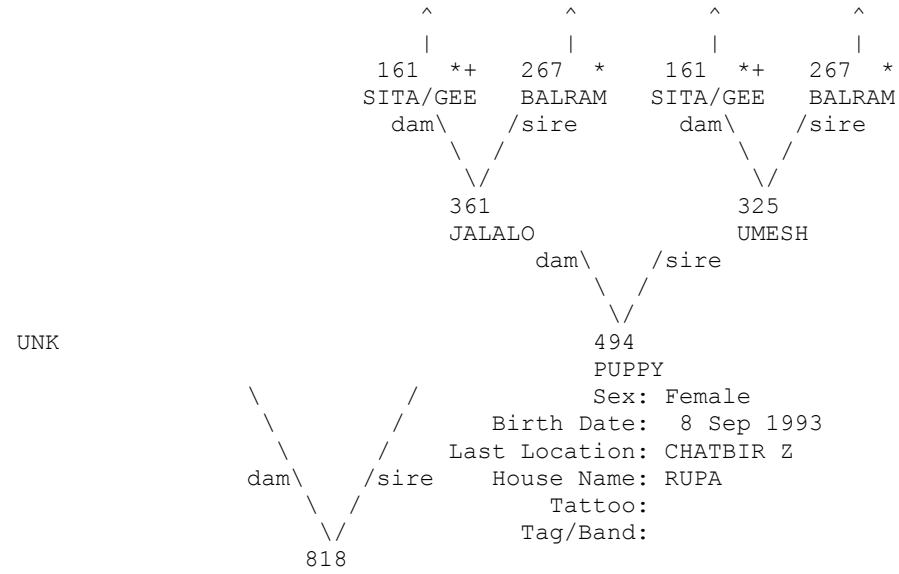

+ Wild-caught... * Appear more than once...
 ^ Pedigree continues beyond top of page...

=====
 Taxon Name: PANTHERA TIGRIS Studbook Number: 819
 =====

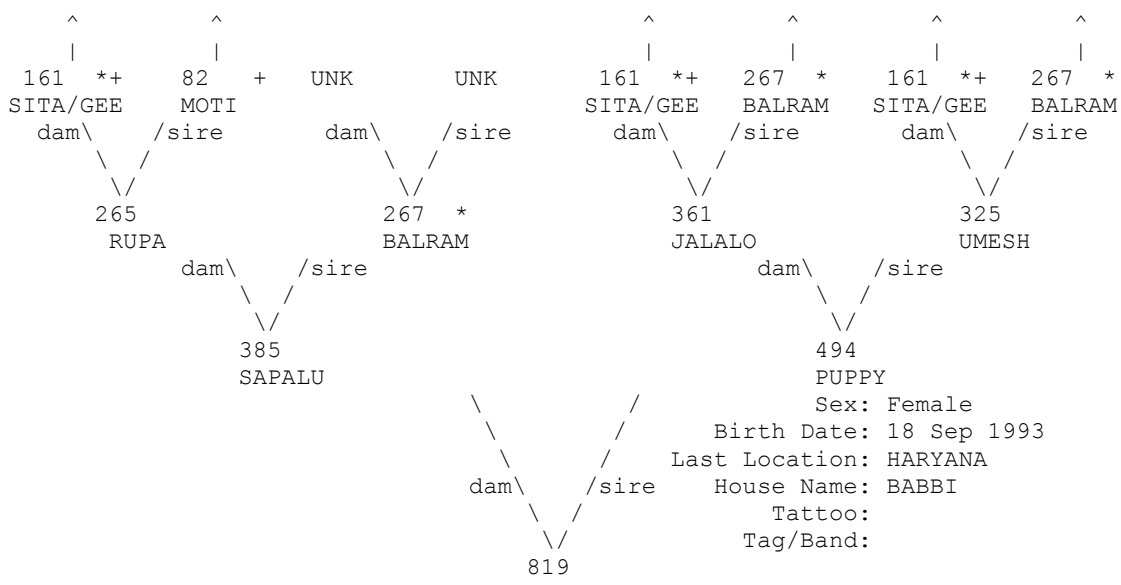

+ Wild-caught... * Appear more than once...
 ^ Pedigree continues beyond top of page...

=====
 Taxon Name: PANTHERA TIGRIS Studbook Number: 820
 =====

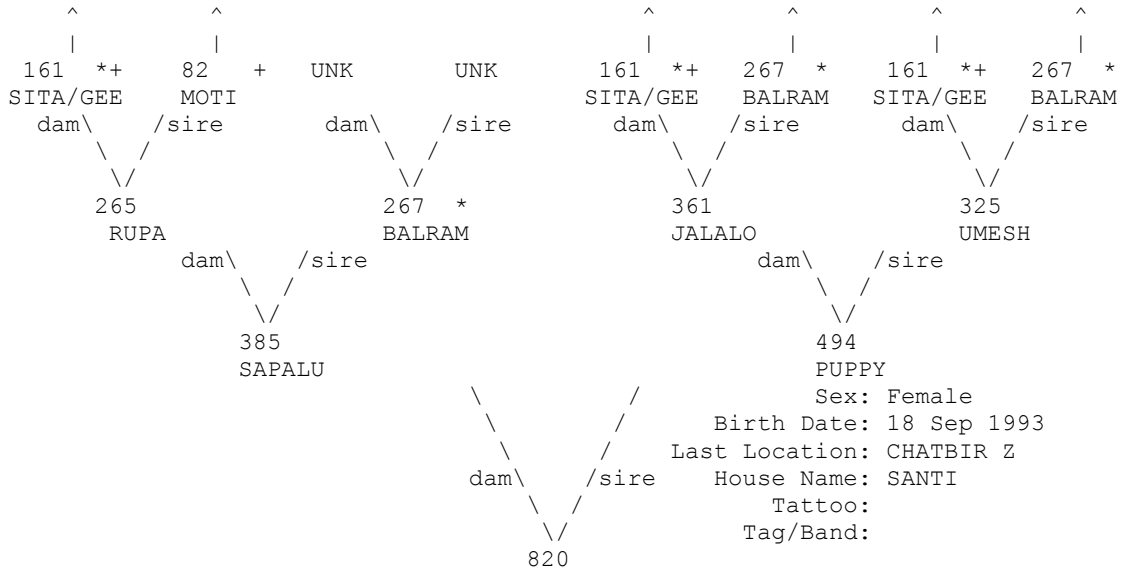

+ Wild-caught... * Appear more than once...
 ^ Pedigree continues beyond top of page...

=====
 Taxon Name: PANTHERA TIGRIS Studbook Number: 821
 =====

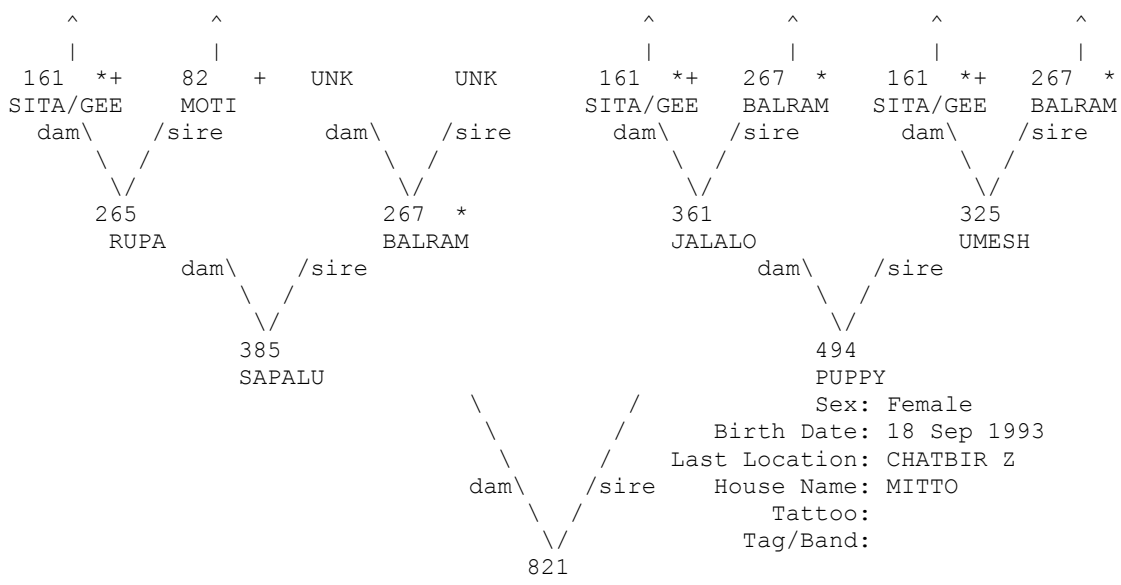

+ Wild-caught... * Appear more than once...
 ^ Pedigree continues beyond top of page...

=====
 Taxon Name: PANTHERA TIGRIS Studbook Number: 822
 =====

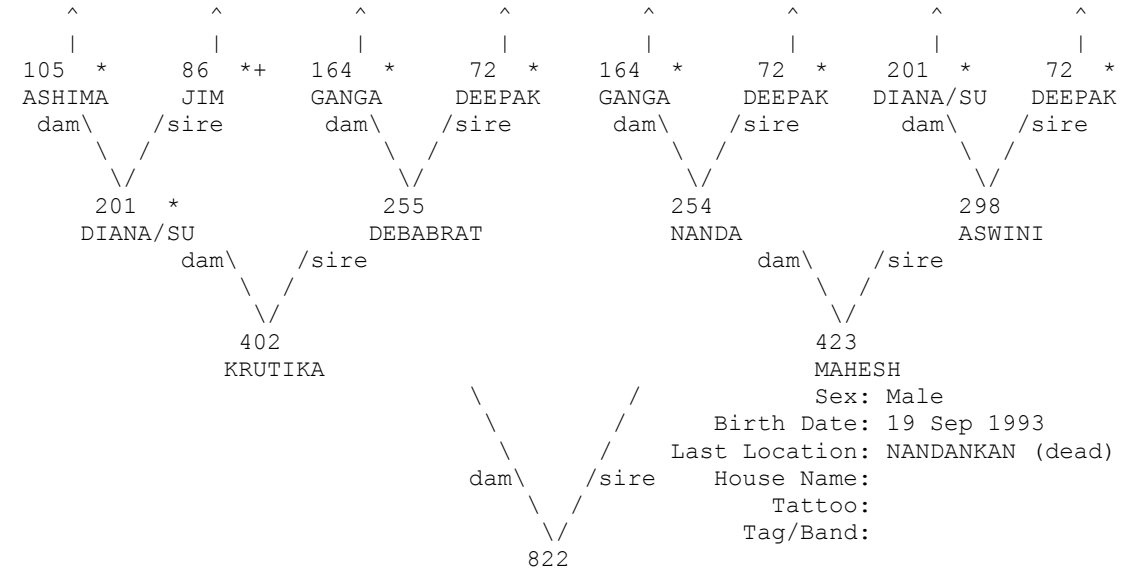

+ Wild-caught... * Appear more than once...
 ^ Pedigree continues beyond top of page...

=====
 Taxon Name: PANTHERA TIGRIS Studbook Number: 823
 =====

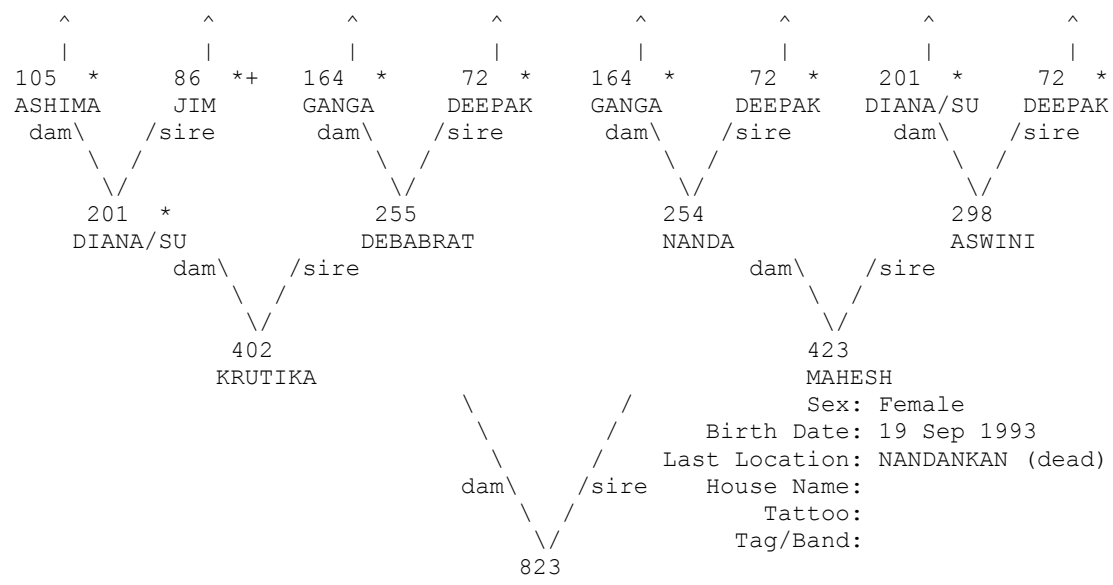

+ Wild-caught... * Appear more than once...
 ^ Pedigree continues beyond top of page...

=====
 Taxon Name: PANTHERA TIGRIS Studbook Number: 824
 =====

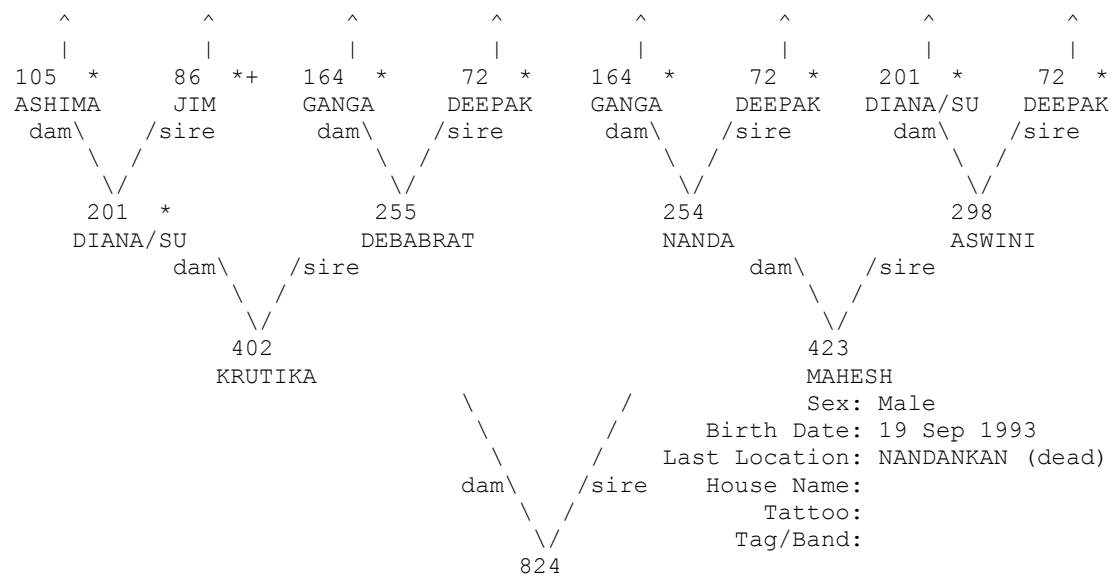

+ Wild-caught... * Appear more than once...
 ^ Pedigree continues beyond top of page...

=====
 Taxon Name: PANTHERA TIGRIS Studbook Number: 825
 =====

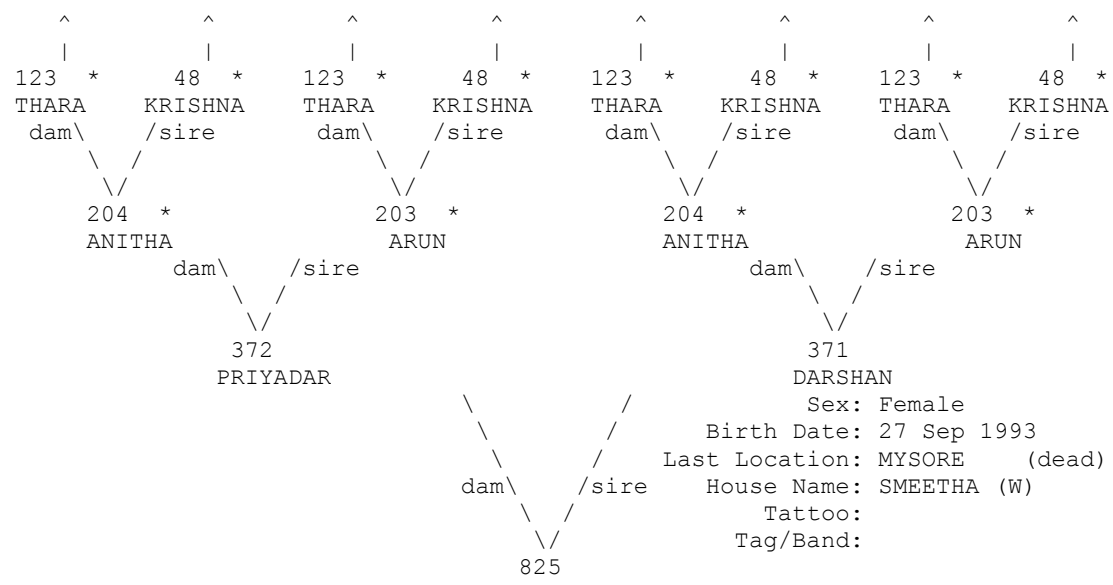

* Appear more than once...
 ^ Pedigree continues beyond top of page...

=====
 Taxon Name: PANTHERA TIGRIS Studbook Number: 826
 =====

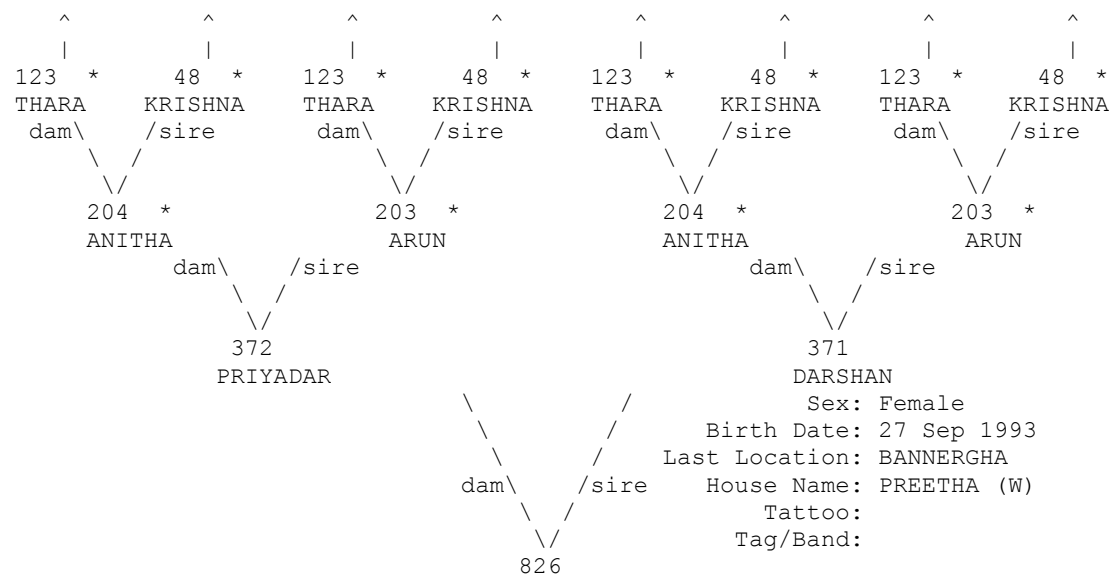

* Appear more than once...
 ^ Pedigree continues beyond top of page...

=====
 Taxon Name: PANTHERA TIGRIS Studbook Number: 827
 =====

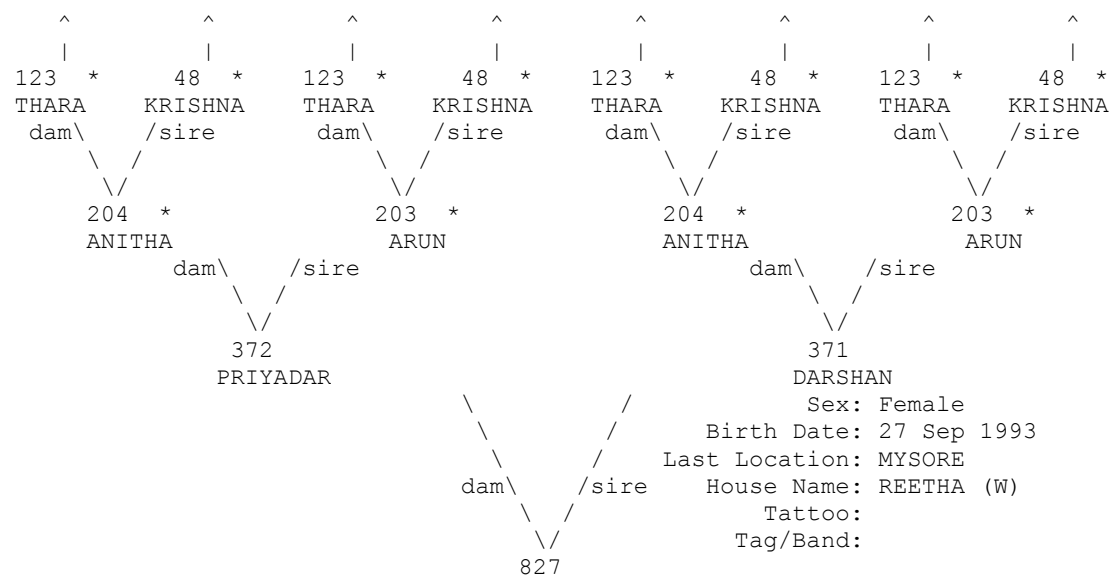

* Appear more than once...
 ^ Pedigree continues beyond top of page...

=====
 Taxon Name: PANTHERA TIGRIS Studbook Number: 828
 =====

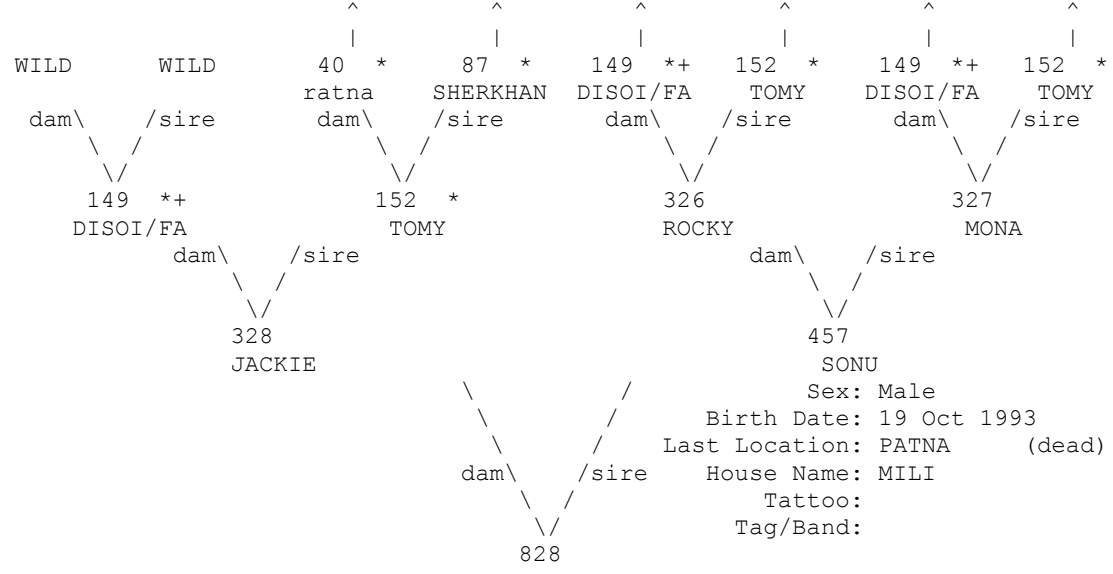

+ Wild-caught... * Appear more than once...
 ^ Pedigree continues beyond top of page...

=====
 Taxon Name: PANTHERA TIGRIS Studbook Number: 833
 =====

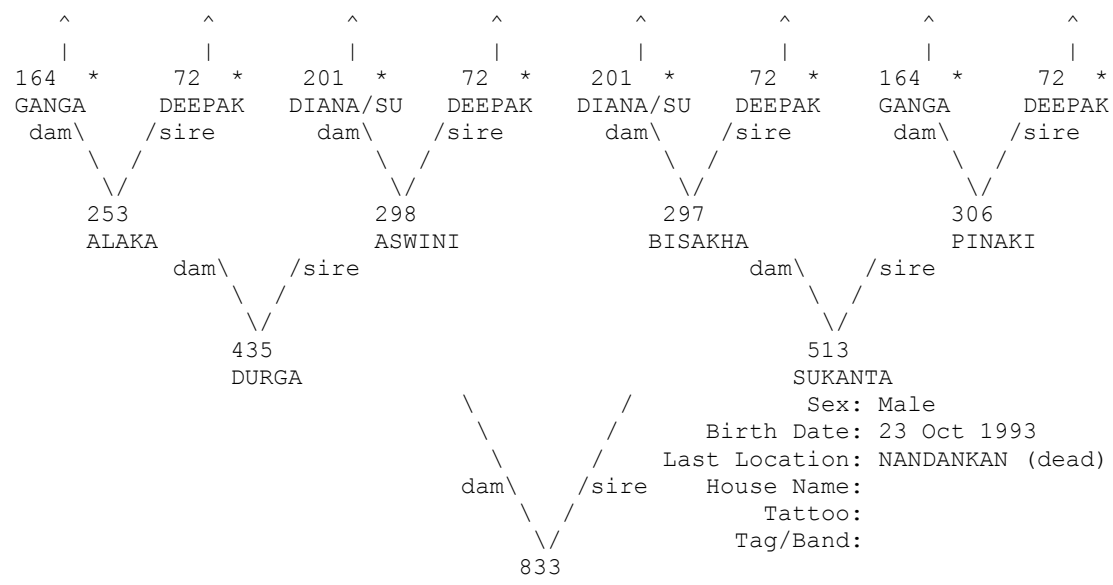

* Appear more than once...
 ^ Pedigree continues beyond top of page...

=====
 Taxon Name: PANTHERA TIGRIS Studbook Number: 834
 =====

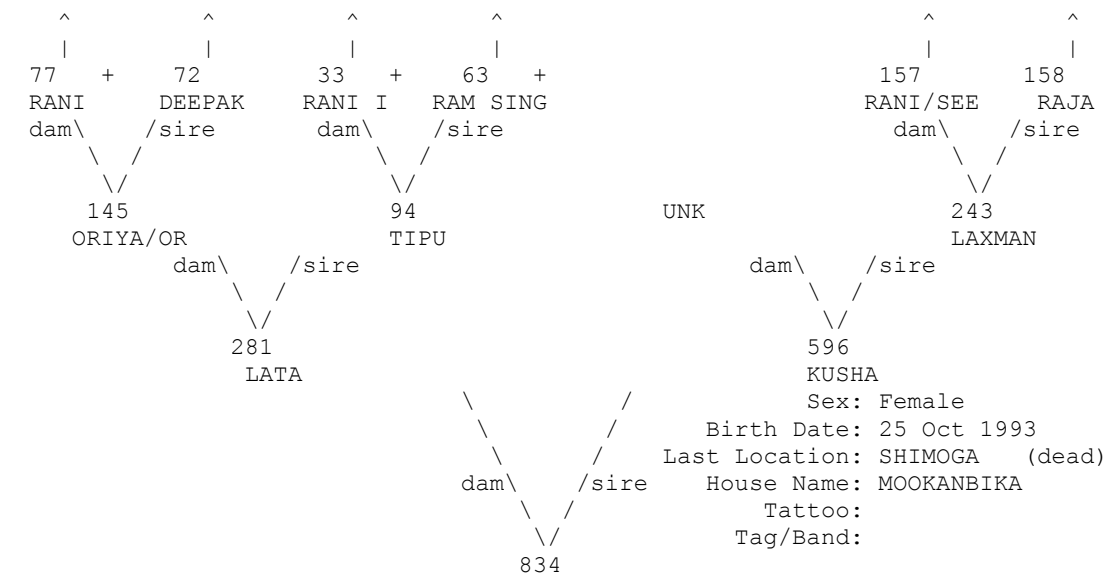

+ Wild-caught... * Appear more than once...
 ^ Pedigree continues beyond top of page...

=====
 Taxon Name: PANTHERA TIGRIS Studbook Number: 835
 =====

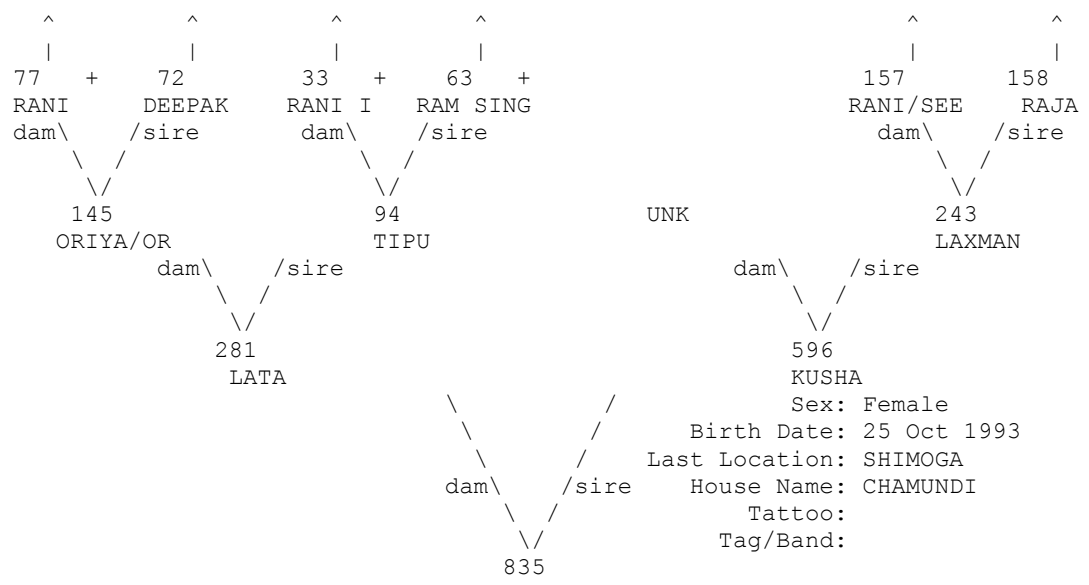

+ Wild-caught... * Appear more than once...
 ^ Pedigree continues beyond top of page...

=====
 Taxon Name: PANTHERA TIGRIS Studbook Number: 836
 =====

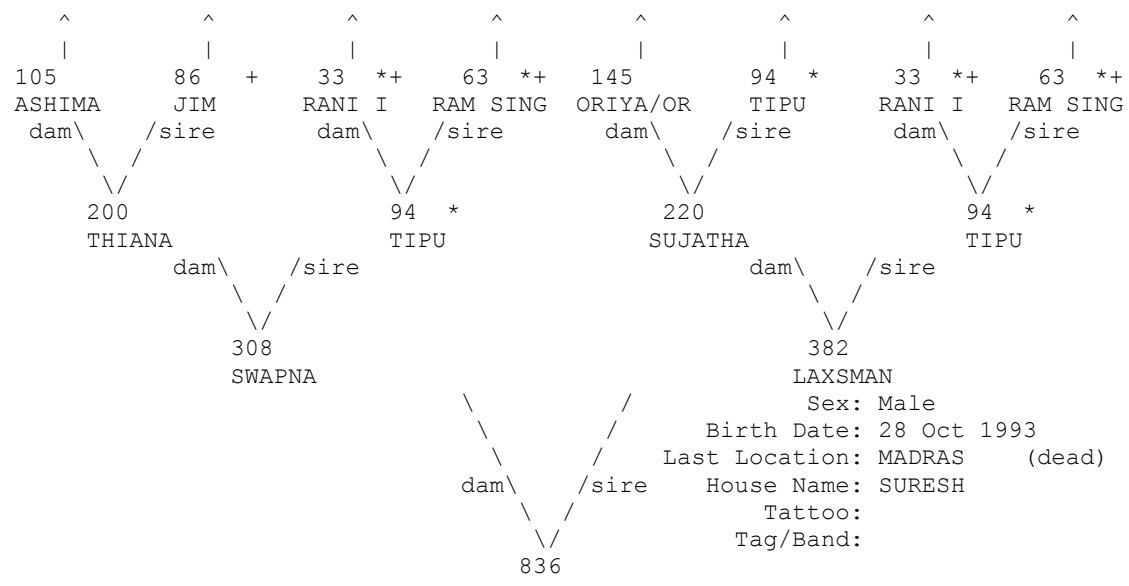

+ Wild-caught... * Appear more than once...
 ^ Pedigree continues beyond top of page...

=====
 Taxon Name: PANTHERA TIGRIS Studbook Number: 837
 =====

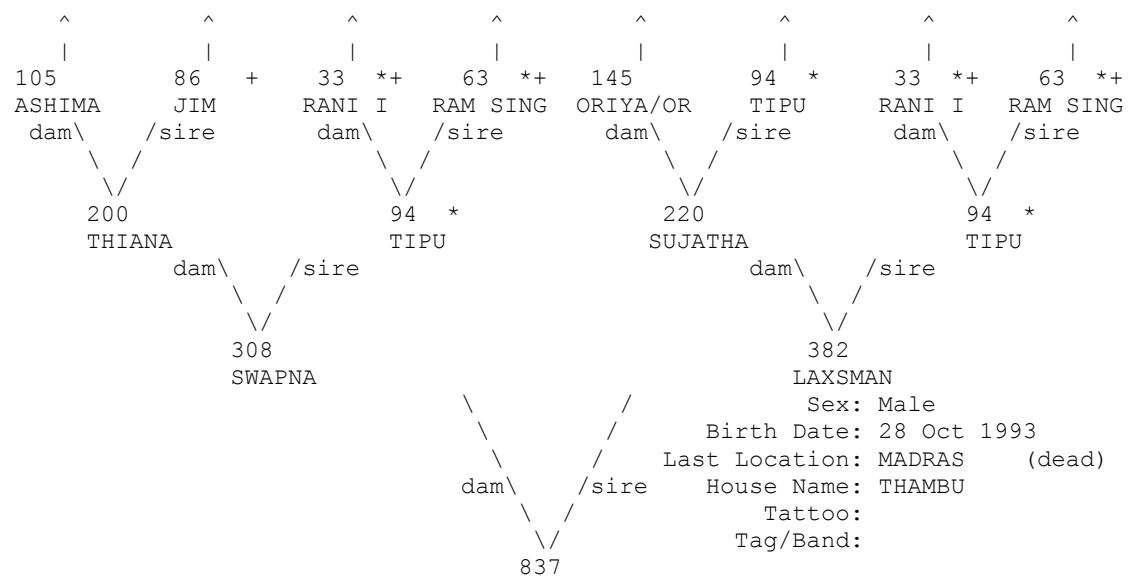

+ Wild-caught... * Appear more than once...
 ^ Pedigree continues beyond top of page...

=====
 Taxon Name: PANTHERA TIGRIS Studbook Number: 838
 =====

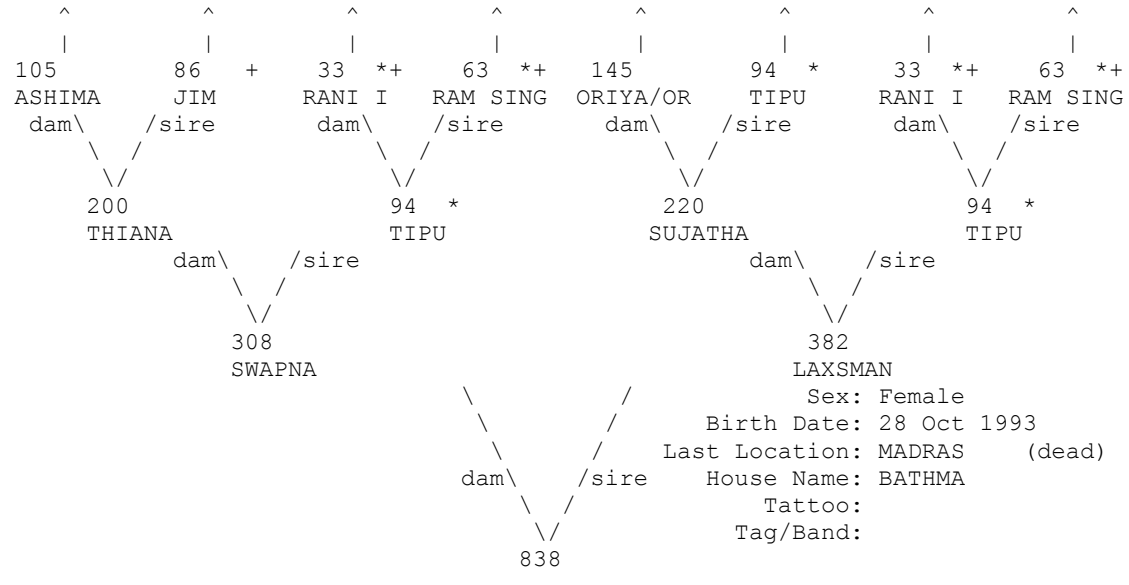

+ Wild-caught... * Appear more than once...
 ^ Pedigree continues beyond top of page...

=====
 Taxon Name: PANTHERA TIGRIS Studbook Number: 839
 =====

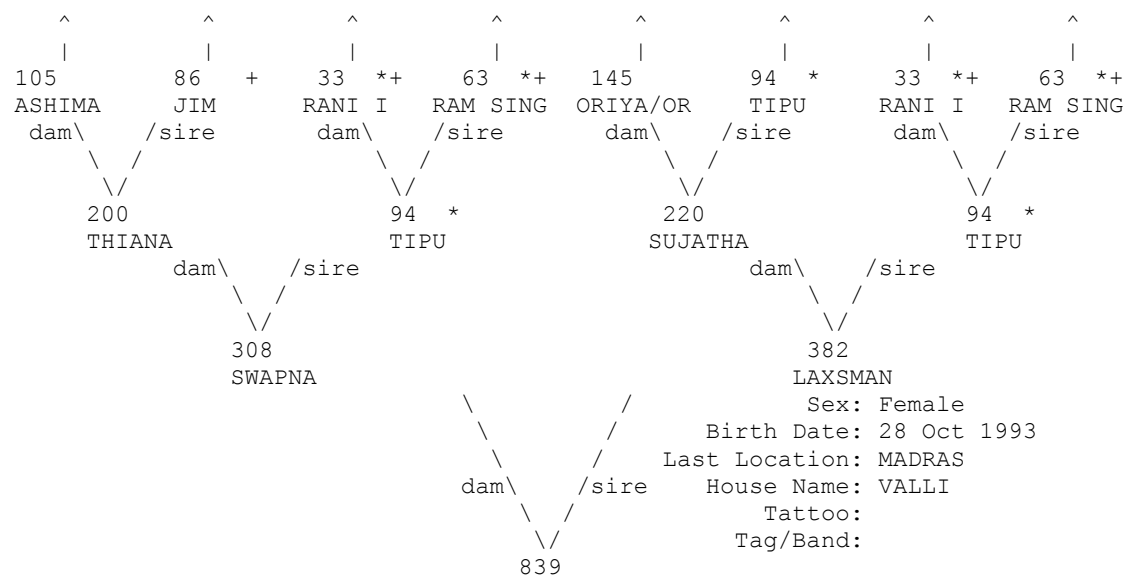

+ Wild-caught... * Appear more than once...
 ^ Pedigree continues beyond top of page...

=====
 Taxon Name: PANTHERA TIGRIS Studbook Number: 840
 =====

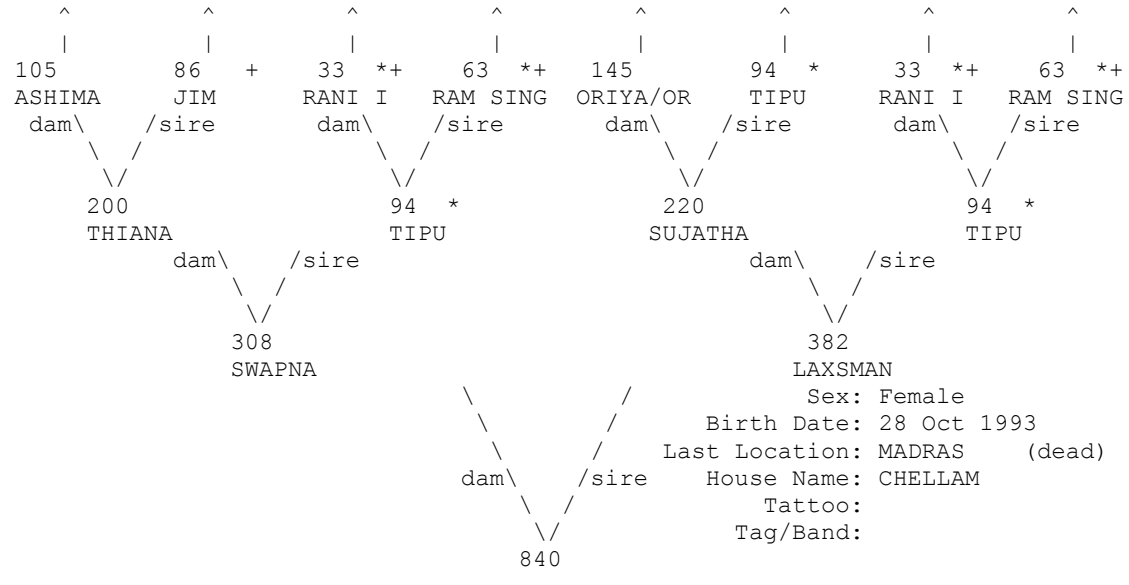

+ Wild-caught... * Appear more than once...
 ^ Pedigree continues beyond top of page...

=====
 Taxon Name: PANTHERA TIGRIS Studbook Number: 841
 =====

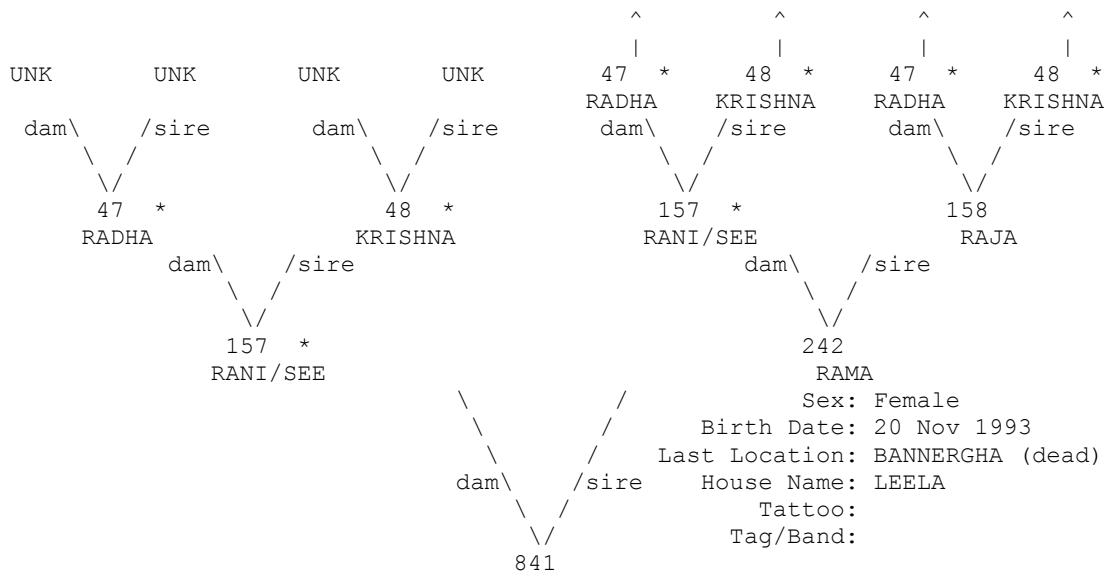

* Appear more than once...
 ^ Pedigree continues beyond top of page...

=====
 Taxon Name: PANTHERA TIGRIS Studbook Number: 842
 =====

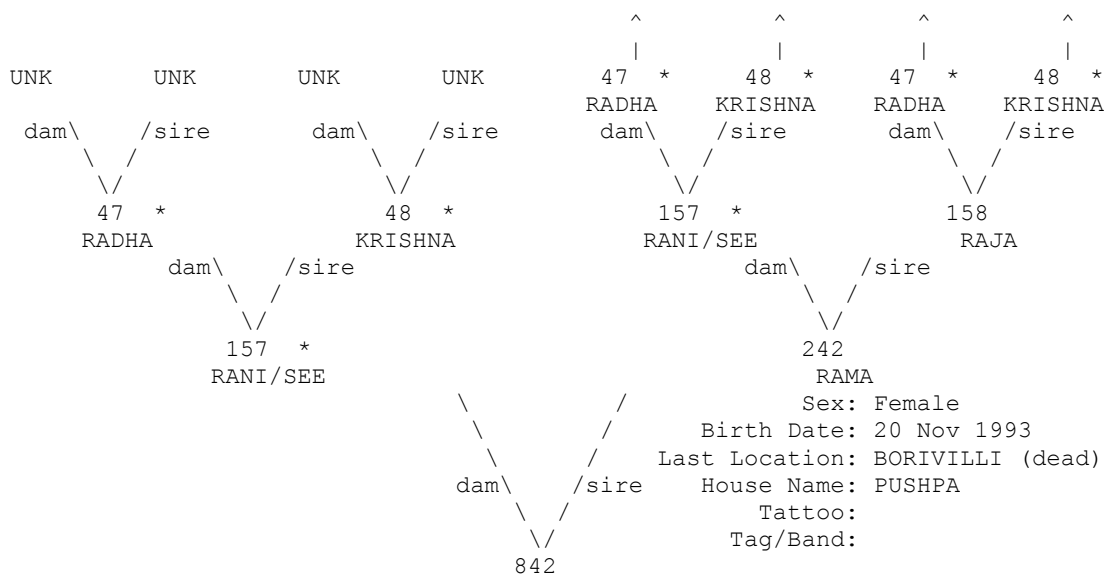

* Appear more than once...
 ^ Pedigree continues beyond top of page...

=====
 Taxon Name: PANTHERA TIGRIS Studbook Number: 843
 =====

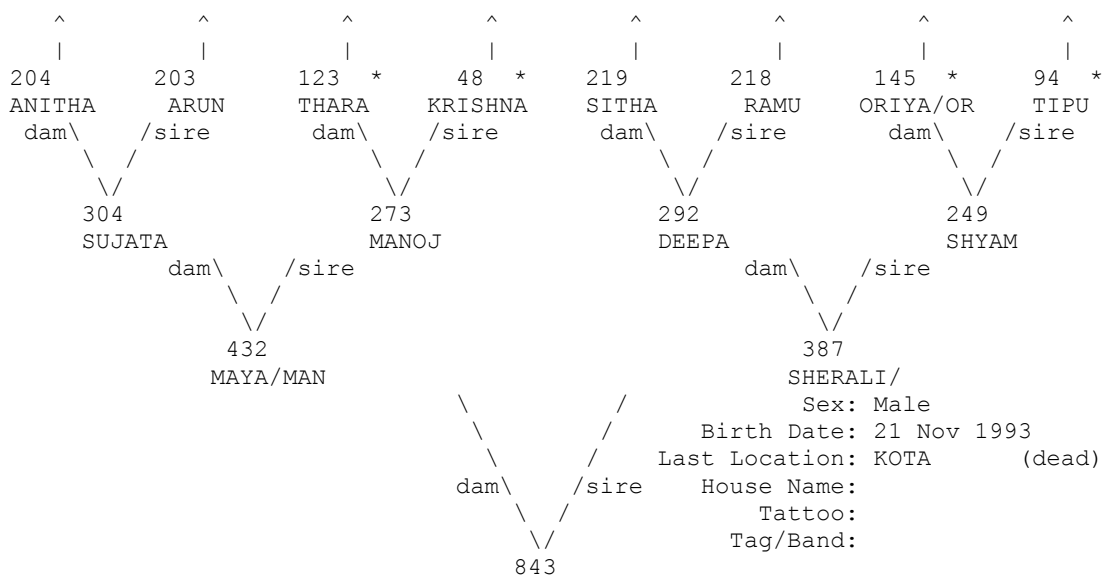

* Appear more than once...
 ^ Pedigree continues beyond top of page...

=====
 Taxon Name: PANTHERA TIGRIS Studbook Number: 844
 =====

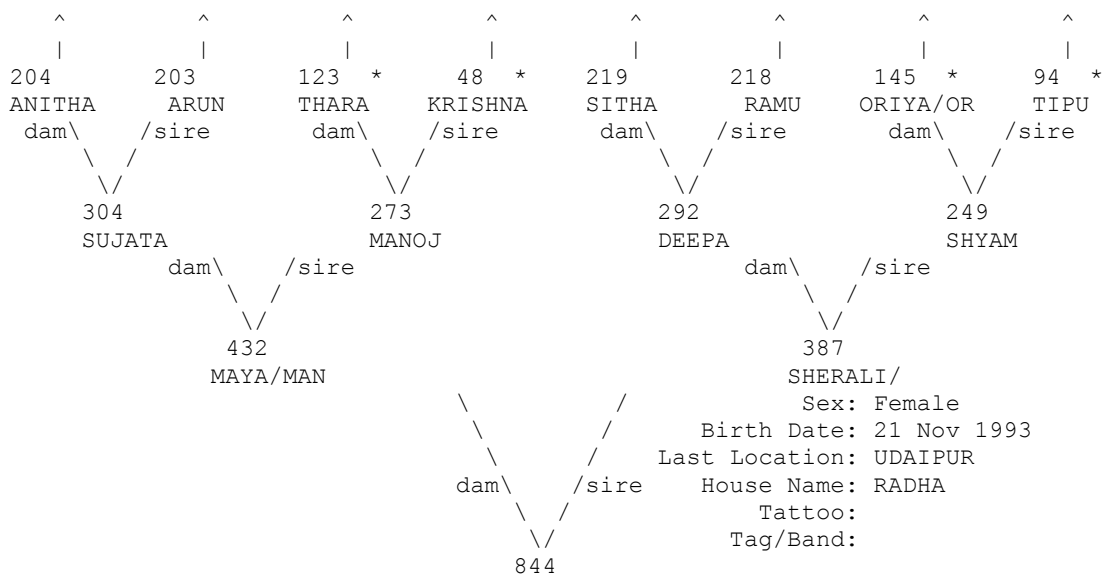

* Appear more than once...
 ^ Pedigree continues beyond top of page...

=====
 Taxon Name: PANTHERA TIGRIS Studbook Number: 847
 =====

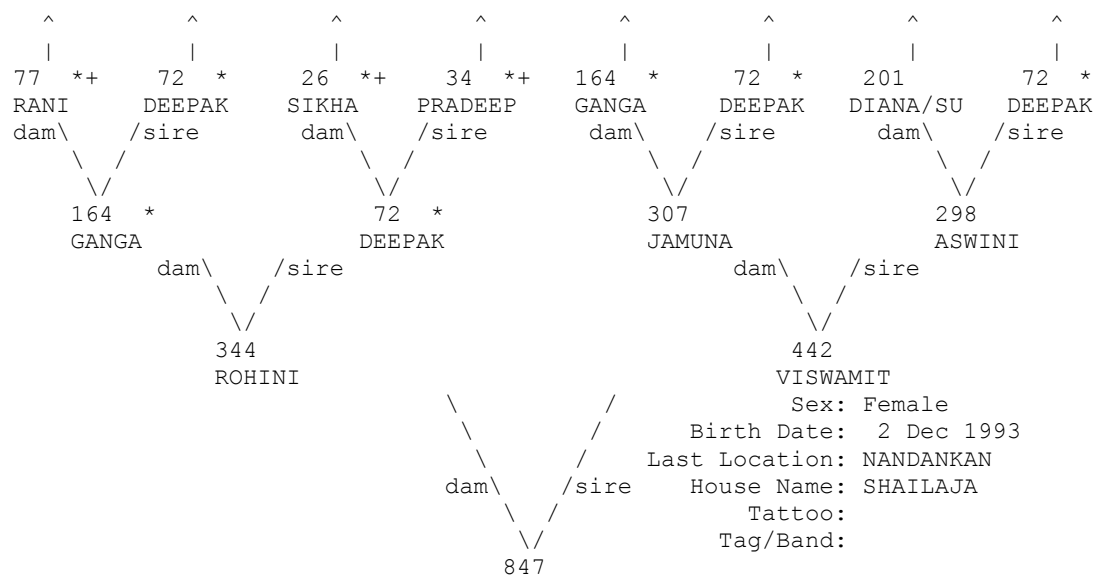

+ Wild-caught... * Appear more than once...
 ^ Pedigree continues beyond top of page...

=====
 Taxon Name: PANTHERA TIGRIS Studbook Number: 848
 =====

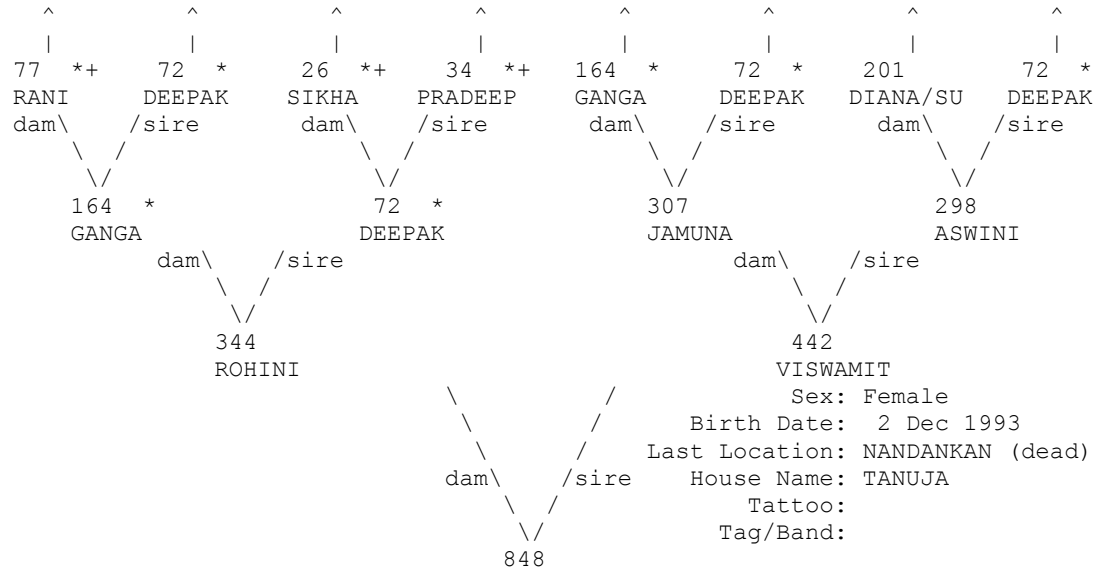

+ Wild-caught... * Appear more than once...
 ^ Pedigree continues beyond top of page...

=====
 Taxon Name: PANTHERA TIGRIS Studbook Number: 849
 =====

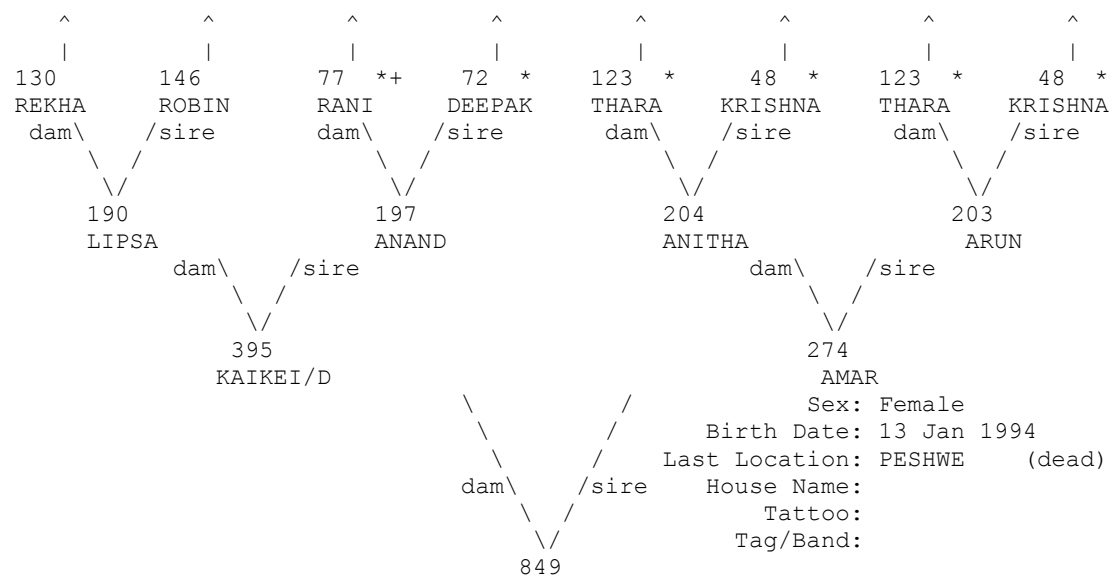

+ Wild-caught... * Appear more than once...
 ^ Pedigree continues beyond top of page...

=====
 Taxon Name: PANTHERA TIGRIS Studbook Number: 850
 =====

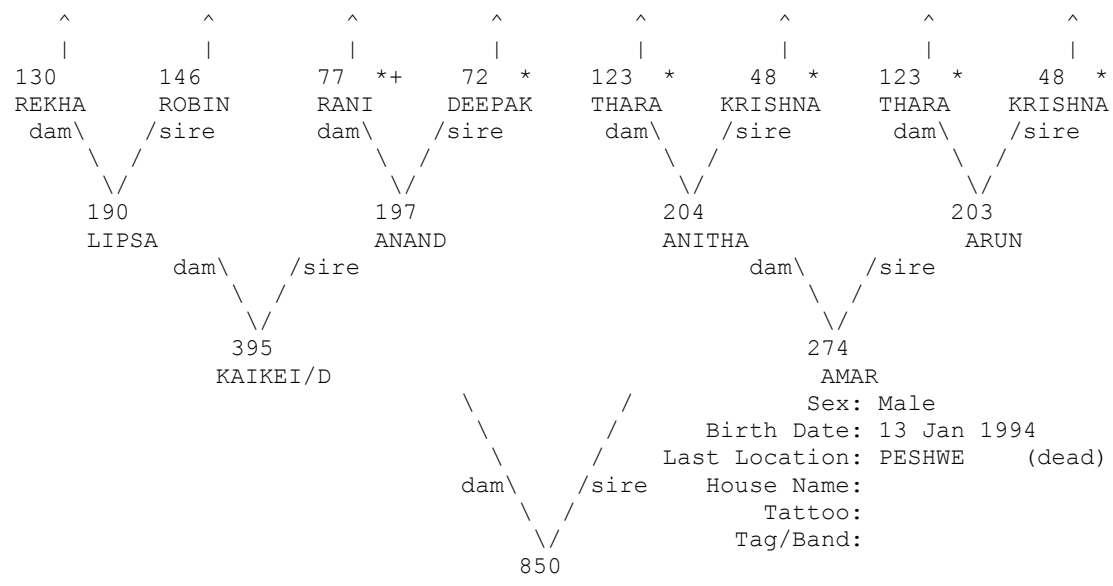

+ Wild-caught... * Appear more than once...
 ^ Pedigree continues beyond top of page...

=====
 Taxon Name: PANTHERA TIGRIS Studbook Number: 851
 =====

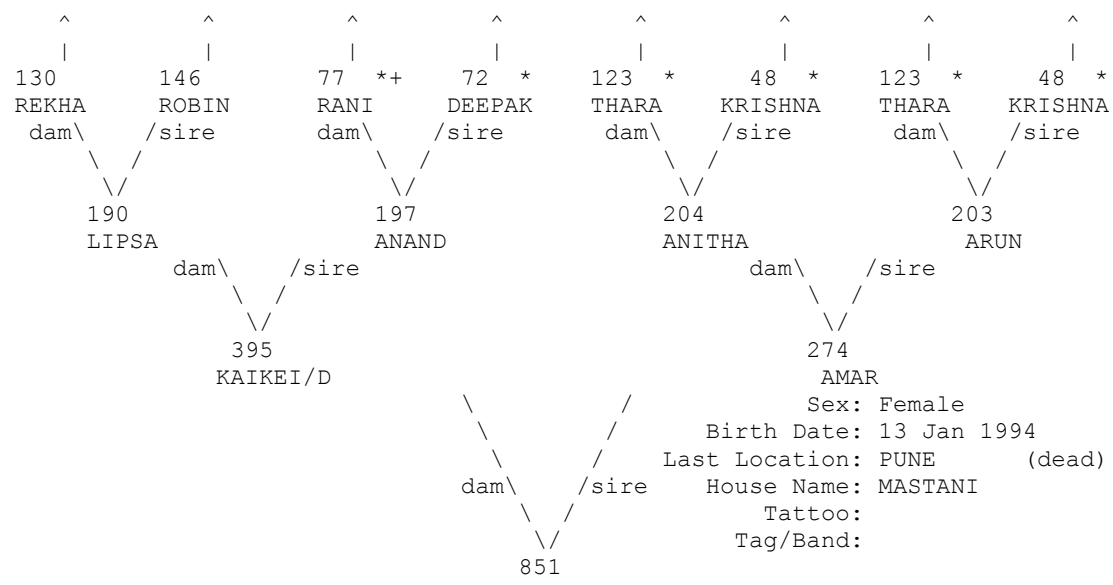

+ Wild-caught... * Appear more than once...
 ^ Pedigree continues beyond top of page...

=====
 Taxon Name: PANTHERA TIGRIS Studbook Number: 852
 =====

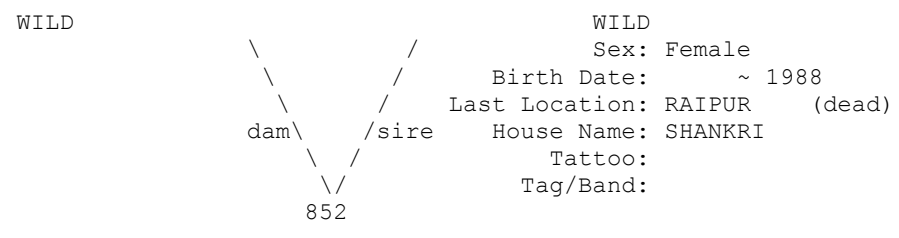

=====
 Taxon Name: PANTHERA TIGRIS Studbook Number: 853
 =====

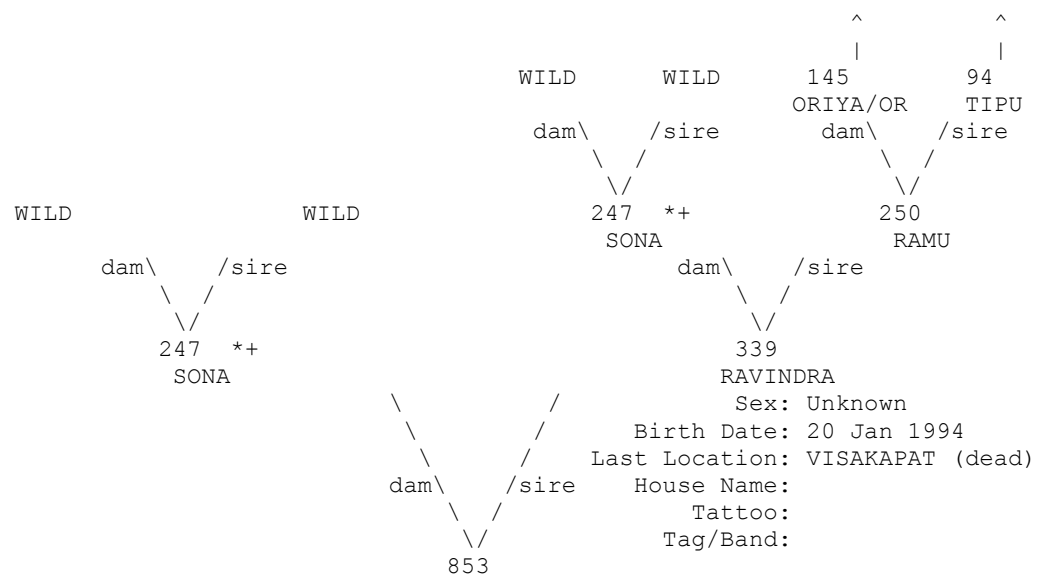

+ Wild-caught... * Appear more than once...
 ^ Pedigree continues beyond top of page...

=====
 Taxon Name: PANTHERA TIGRIS Studbook Number: 854
 =====

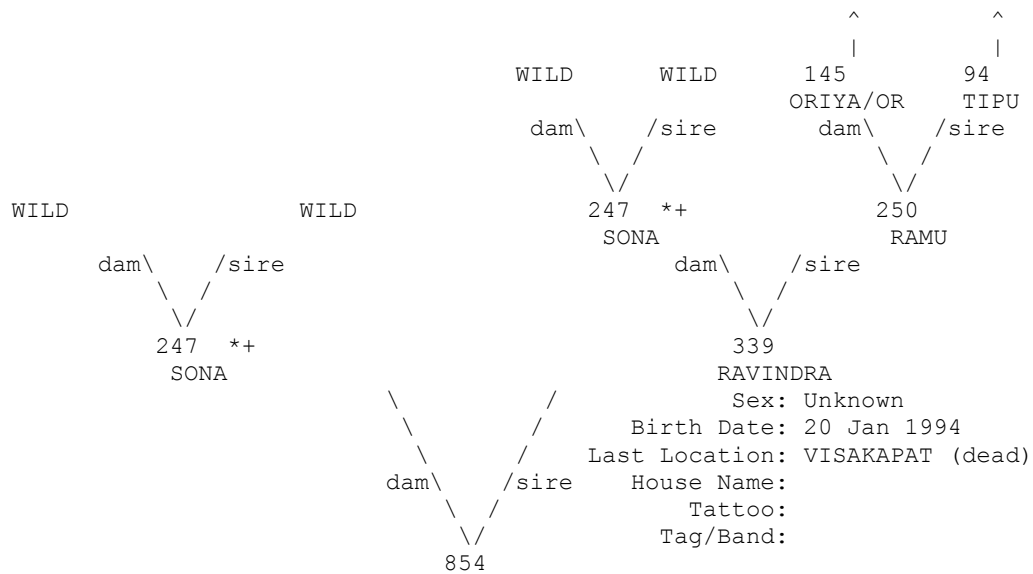

+ Wild-caught... * Appear more than once...
 ^ Pedigree continues beyond top of page...

=====
 Taxon Name: PANTHERA TIGRIS Studbook Number: 855
 =====

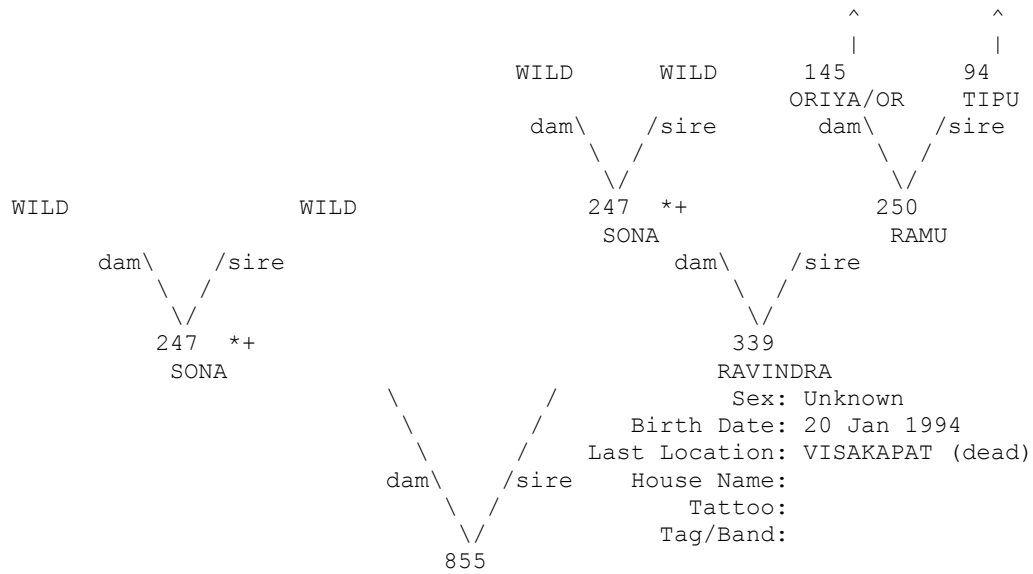

+ Wild-caught... * Appear more than once...
 ^ Pedigree continues beyond top of page...

=====
 Taxon Name: PANTHERA TIGRIS Studbook Number: 856
 =====

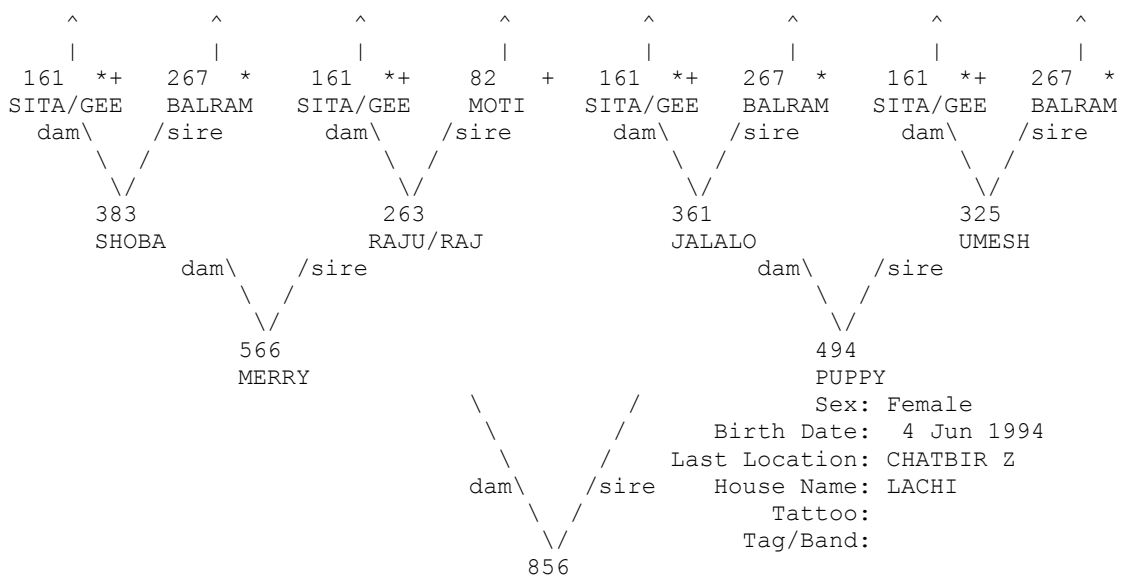

+ Wild-caught... * Appear more than once...
 ^ Pedigree continues beyond top of page...

=====
 Taxon Name: PANTHERA TIGRIS Studbook Number: 857
 =====

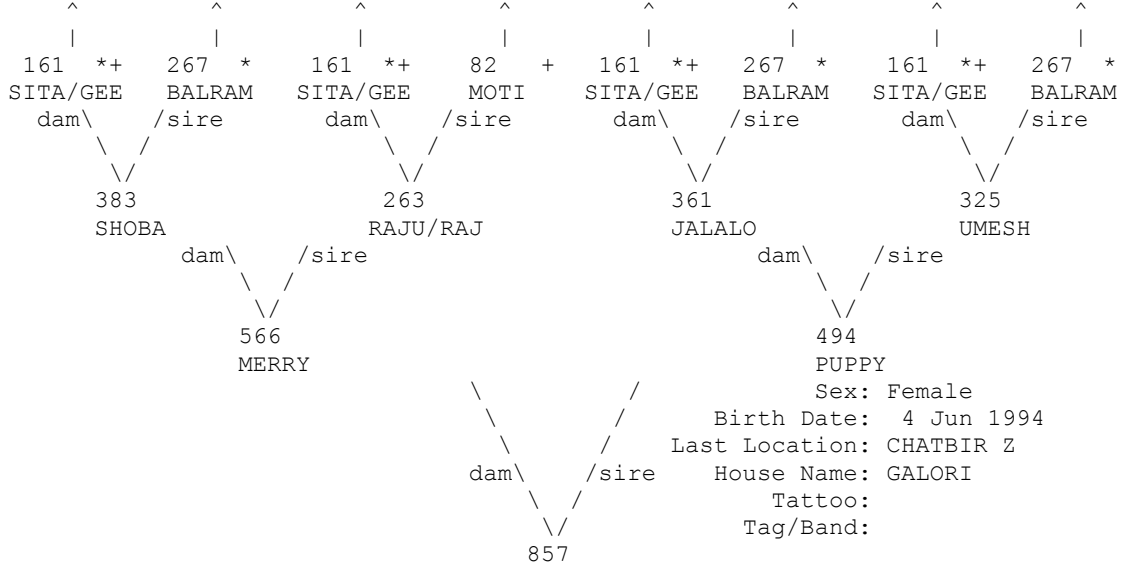

+ Wild-caught... * Appear more than once...
 ^ Pedigree continues beyond top of page...

=====
 Taxon Name: PANTHERA TIGRIS Studbook Number: 858
 =====

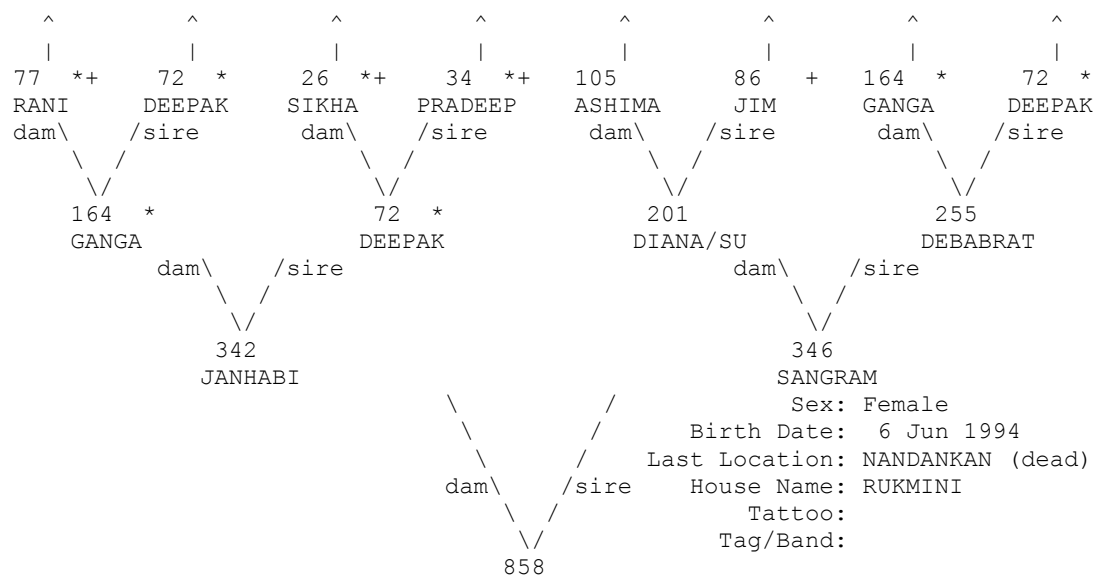

+ Wild-caught... * Appear more than once...
 ^ Pedigree continues beyond top of page...

=====
 Taxon Name: PANTHERA TIGRIS Studbook Number: 859
 =====

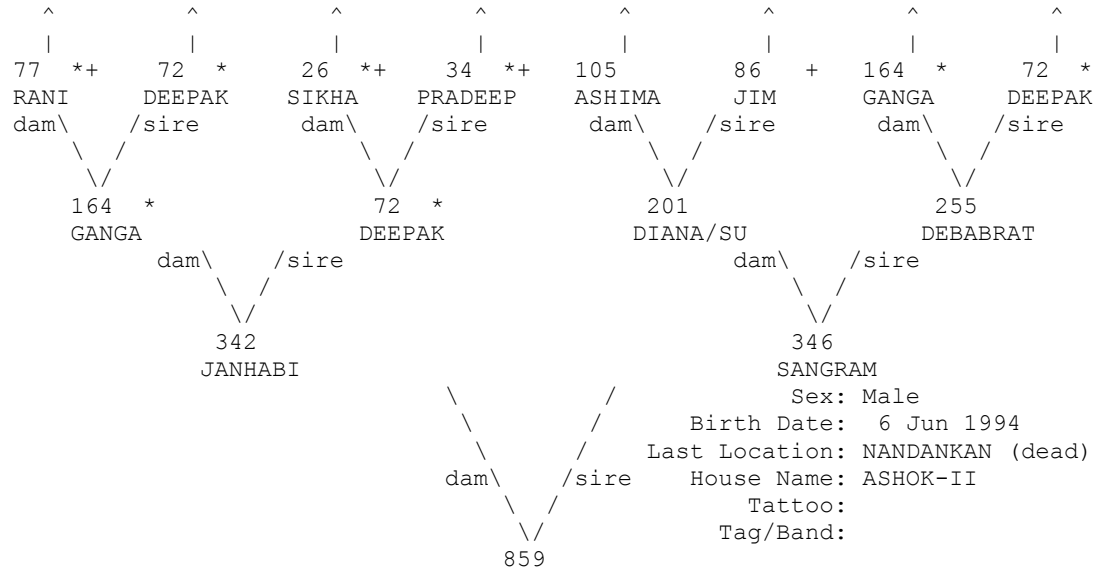

+ Wild-caught... * Appear more than once...
 ^ Pedigree continues beyond top of page...

=====
 Taxon Name: PANTHERA TIGRIS Studbook Number: 860
 =====

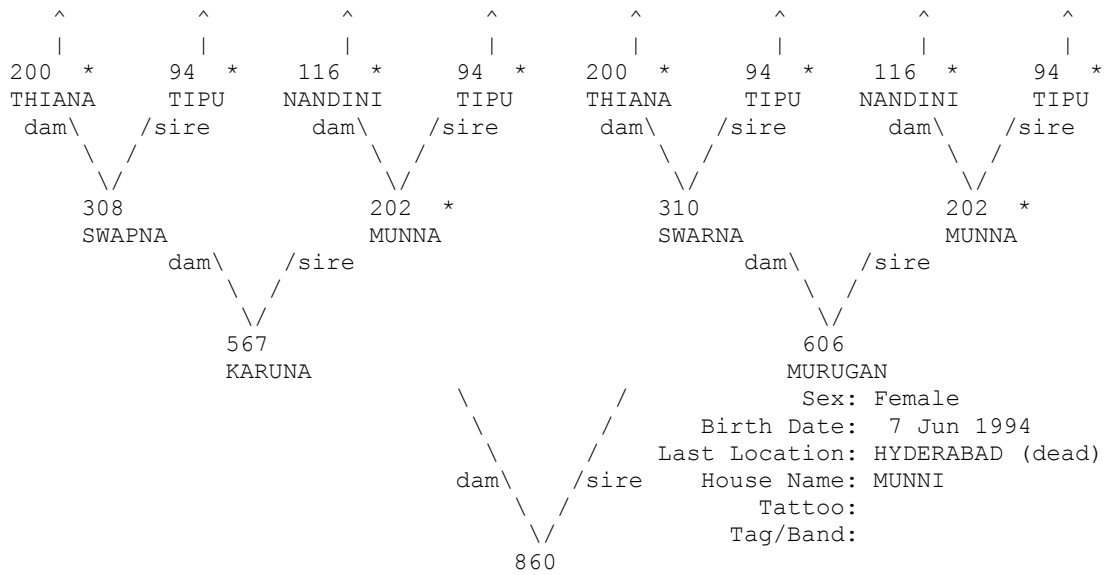

* Appear more than once...
 ^ Pedigree continues beyond top of page...

=====
 Taxon Name: PANTHERA TIGRIS Studbook Number: 861
 =====

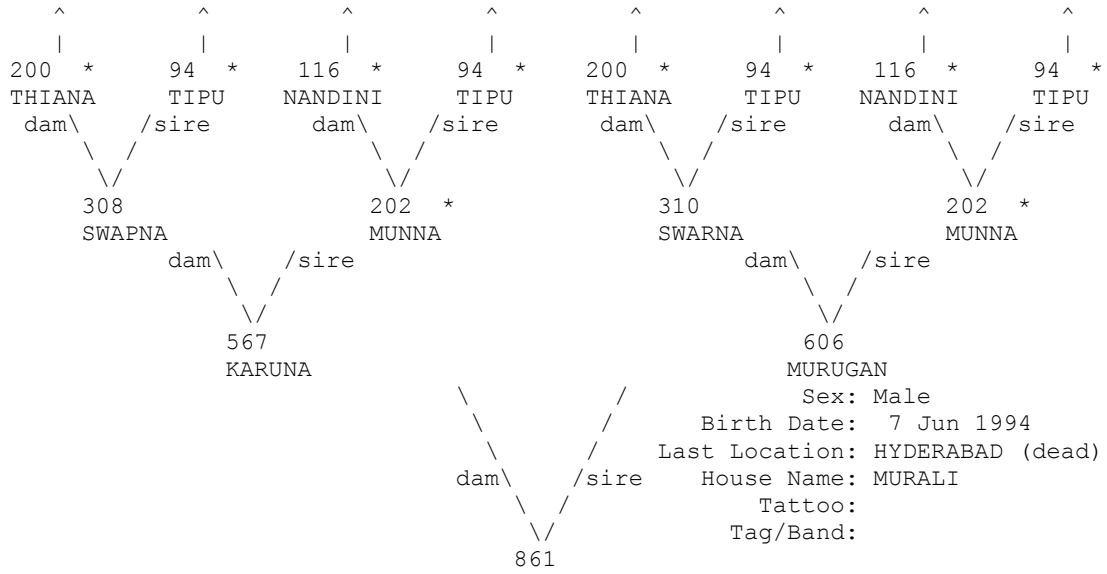

* Appear more than once...
 ^ Pedigree continues beyond top of page...

=====
 Taxon Name: PANTHERA TIGRIS Studbook Number: 862
 =====

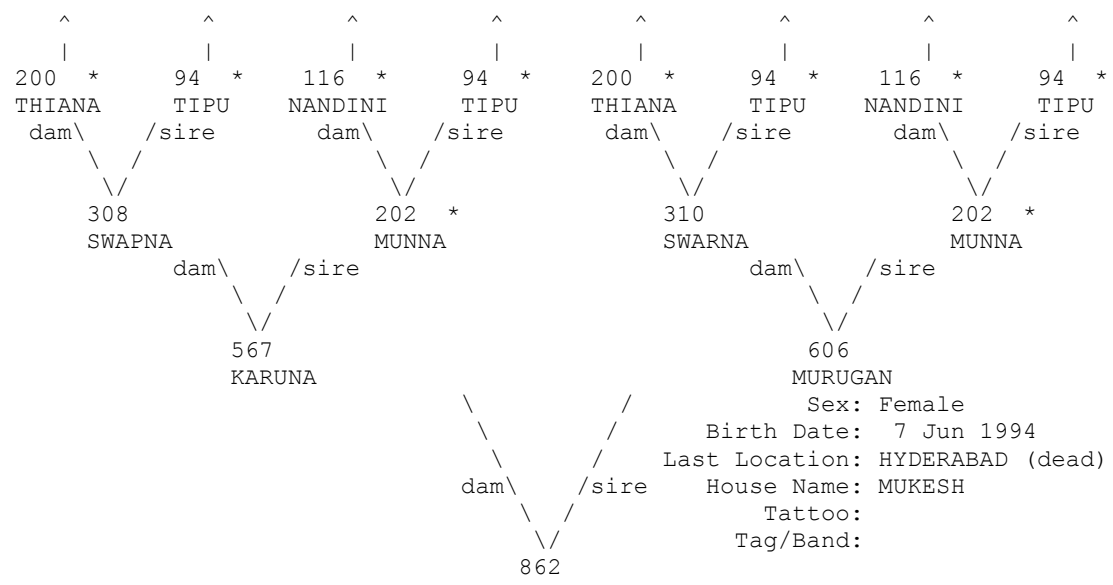

* Appear more than once...
 ^ Pedigree continues beyond top of page...

=====
 Taxon Name: PANTHERA TIGRIS Studbook Number: 863
 =====

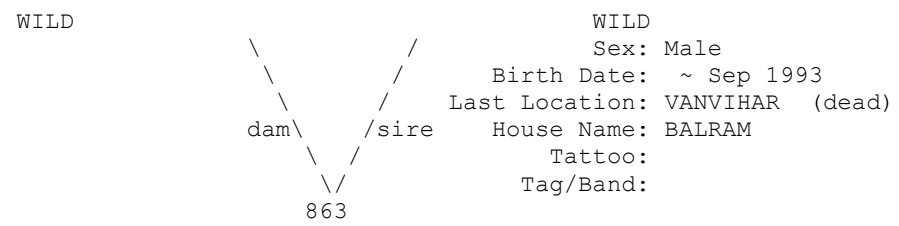

=====
 Taxon Name: PANTHERA TIGRIS Studbook Number: 864
 =====

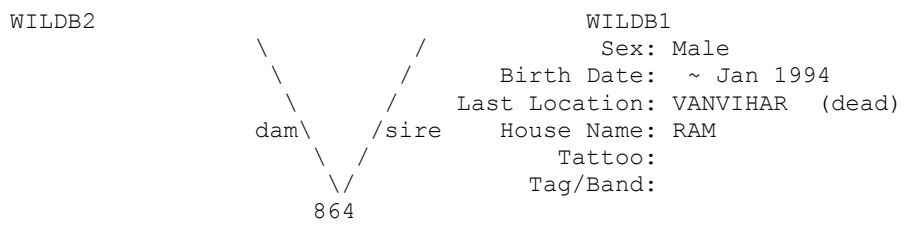

```

=====
Taxon Name: PANTHERA TIGRIS                      Studbook Number: 865
=====
WILDB2                                           WILDB1
                                           Sex: Female
                                           Birth Date: ~ Jan 1994
                                           Last Location: VANVIHAR (dead)
                                           House Name: SEETA
                                           Tattoo:
                                           Tag/Band:
dam \      /
  \      /
   \    /
    \  /
     \ /
      865

```

```

=====
Taxon Name: PANTHERA TIGRIS                      Studbook Number: 866
=====
WILDB2                                           WILDB1
                                           Sex: Female
                                           Birth Date: ~ Jan 1994
                                           Last Location: DELHI (dead)
                                           House Name: GEETA
                                           Tattoo:
                                           Tag/Band:
dam \      /
  \      /
   \    /
    \  /
     \ /
      866

```

```

=====
Taxon Name: PANTHERA TIGRIS                      Studbook Number: 867
=====
^         ^         ^         ^         ^         ^         ^         ^
77  *+   72  *   26  *+   34  *+   105   86  +   164  *   72  *
RANI    DEEPAK  SIKHA    PRADEEP  ASHIMA  JIM    GANGA    DEEPAK
dam \   /sire  dam \   /sire  dam \   /sire  dam \   /sire
  \   /       \   /       \   /       \   /
   \ /         \ /         \ /         \ /
    164 *      72  *      201         255
    GANGA      DEEPAK      DIANA/SU      DEBABRAT
      dam \   /sire
        \   /
         \ /
          380
          RADHA I
                                           dam \   /sire
                                           \   /
                                            \ /
                                             401
                                             KASHYAP
                                             Sex: Male
                                             Birth Date: 14 Jul 1994
                                             Last Location: ASSAM (dead)
                                             House Name:
                                             Tattoo:
                                             Tag/Band:
dam \      /
  \      /
   \    /
    \  /
     \ /
      867

```

+ Wild-caught... * Appear more than once...
^ Pedigree continues beyond top of page...

=====
 Taxon Name: PANTHERA TIGRIS Studbook Number: 868
 =====

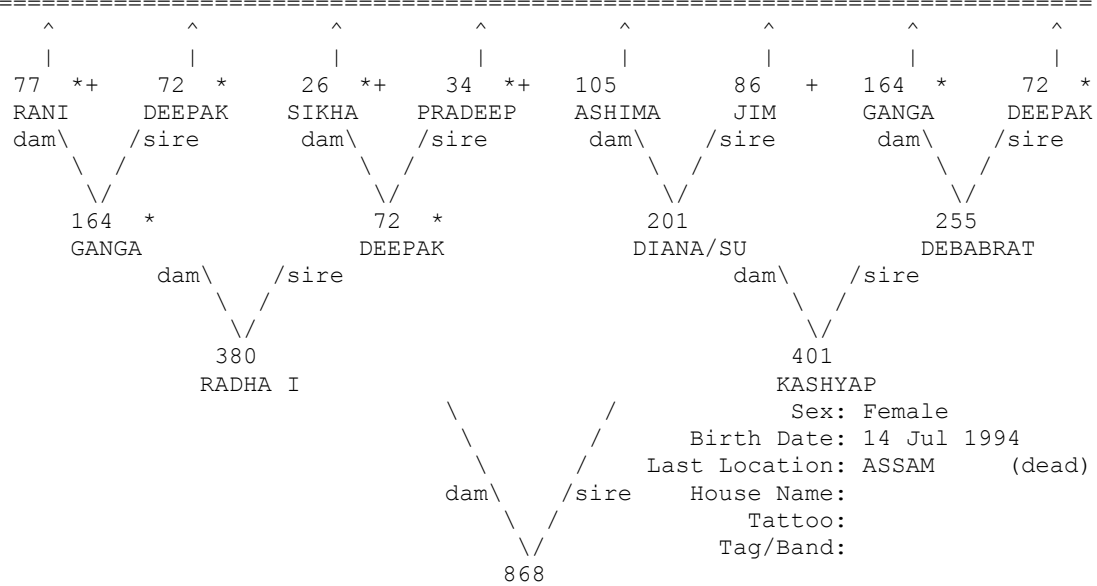

+ Wild-caught... * Appear more than once...
 ^ Pedigree continues beyond top of page...

=====
 Taxon Name: PANTHERA TIGRIS Studbook Number: 869
 =====

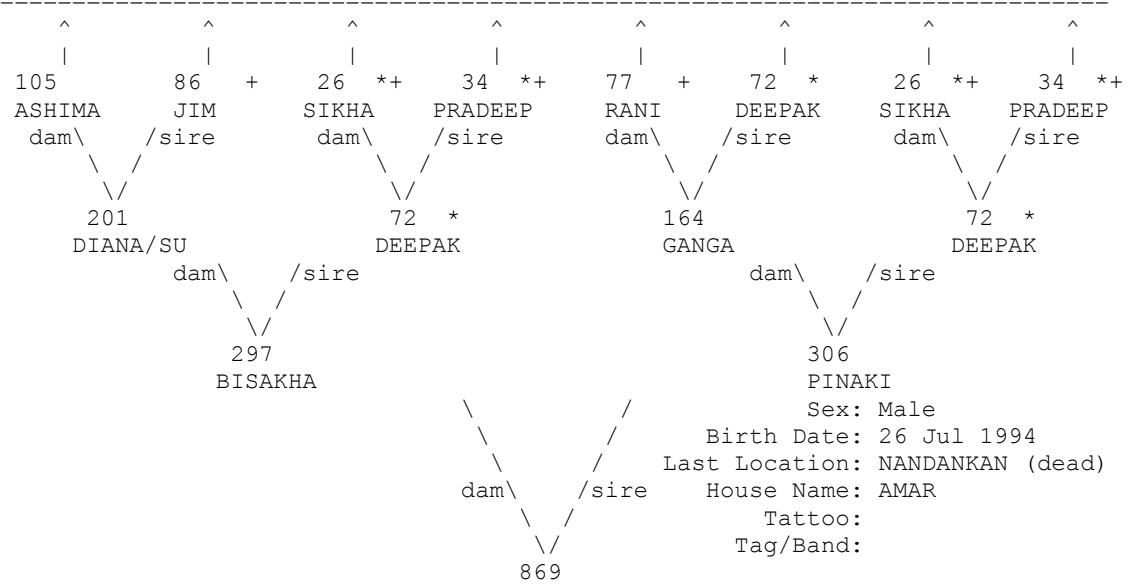

+ Wild-caught... * Appear more than once...
 ^ Pedigree continues beyond top of page...

=====
 Taxon Name: PANTHERA TIGRIS Studbook Number: 870
 =====

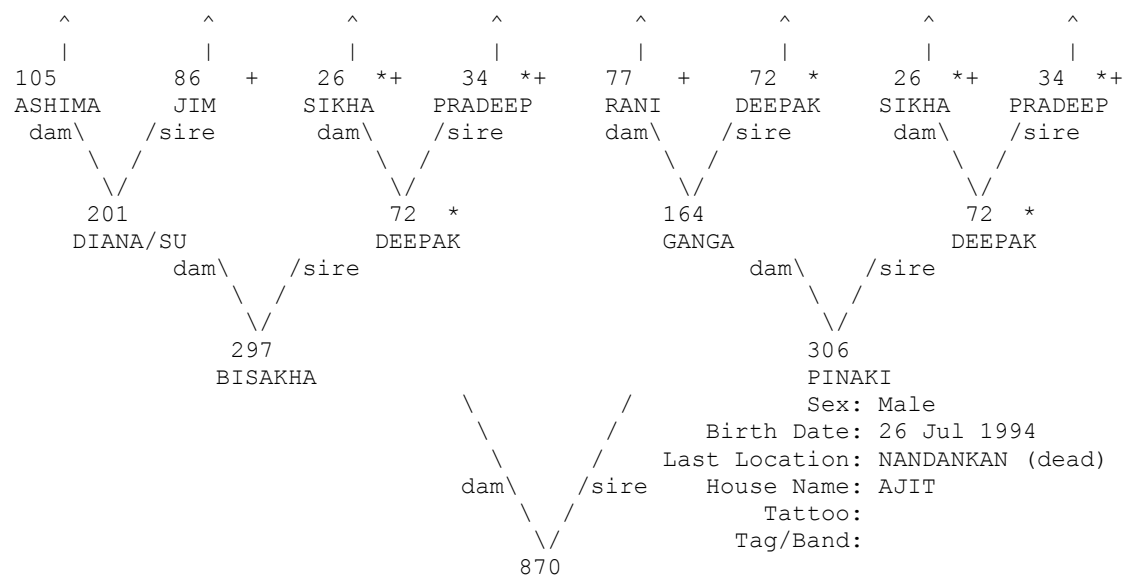

+ Wild-caught... * Appear more than once...
 ^ Pedigree continues beyond top of page...

=====
 Taxon Name: PANTHERA TIGRIS Studbook Number: 871
 =====

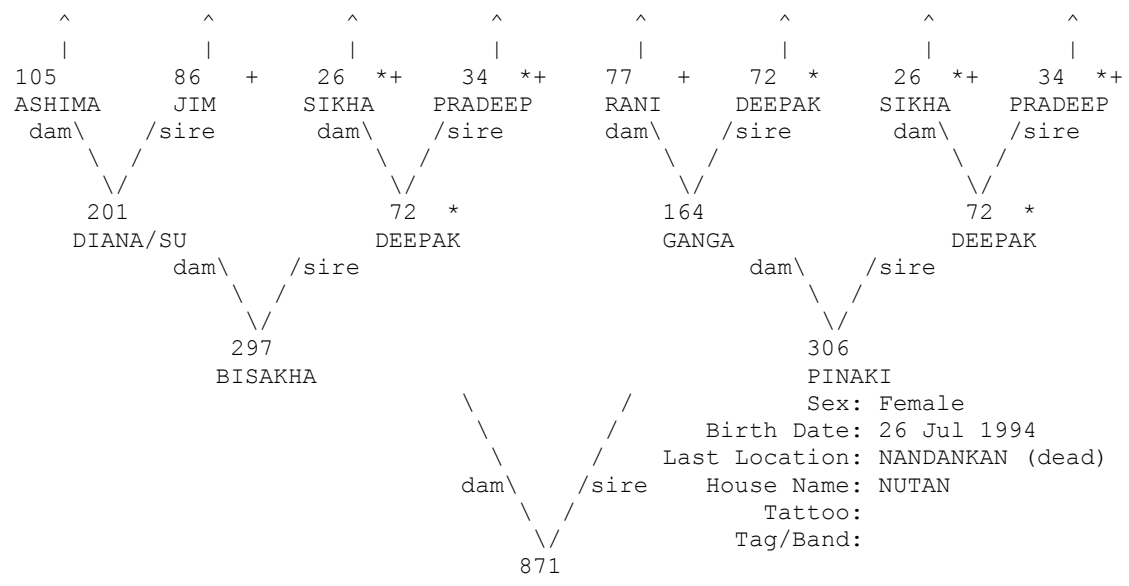

+ Wild-caught... * Appear more than once...
 ^ Pedigree continues beyond top of page...

=====
 Taxon Name: PANTHERA TIGRIS Studbook Number: 872
 =====

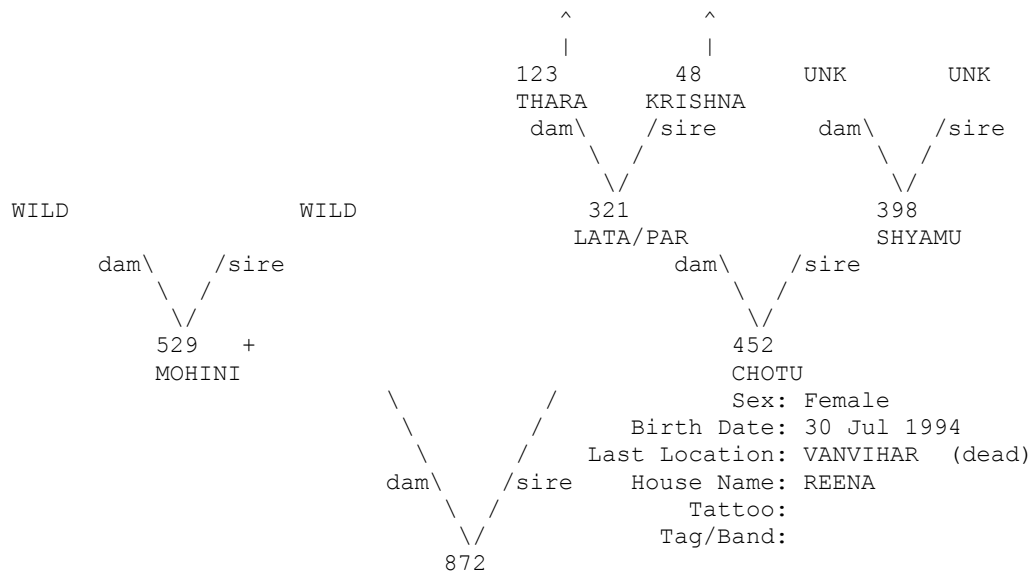

+ Wild-caught...
 ^ Pedigree continues beyond top of page...

=====
 Taxon Name: PANTHERA TIGRIS Studbook Number: 873
 =====

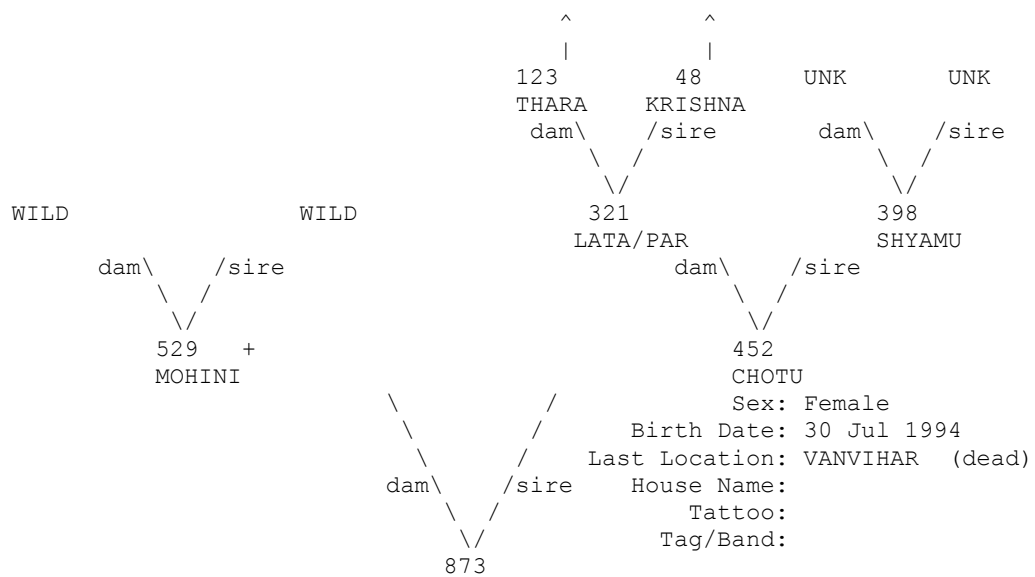

+ Wild-caught...
 ^ Pedigree continues beyond top of page...

=====
 Taxon Name: PANTHERA TIGRIS Studbook Number: 874
 =====

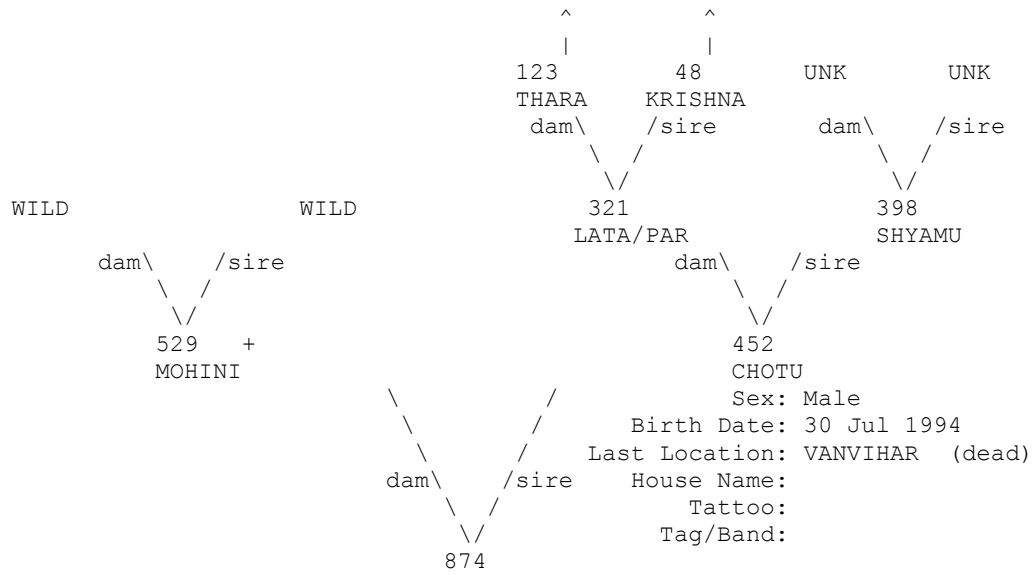

+ Wild-caught...
 ^ Pedigree continues beyond top of page...

=====
 Taxon Name: PANTHERA TIGRIS Studbook Number: 875
 =====

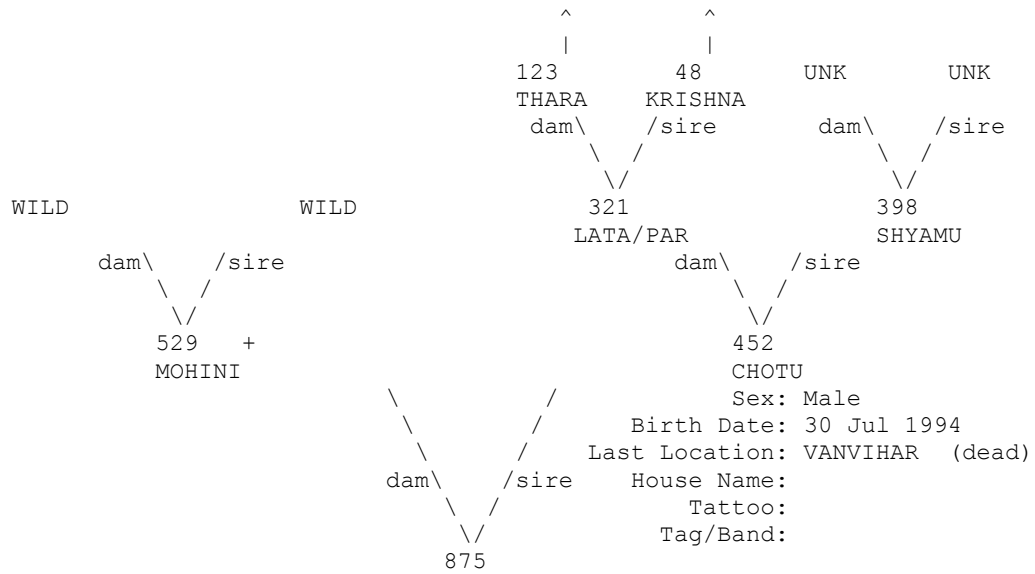

+ Wild-caught...
 ^ Pedigree continues beyond top of page...

=====
 Taxon Name: PANTHERA TIGRIS Studbook Number: 878
 =====

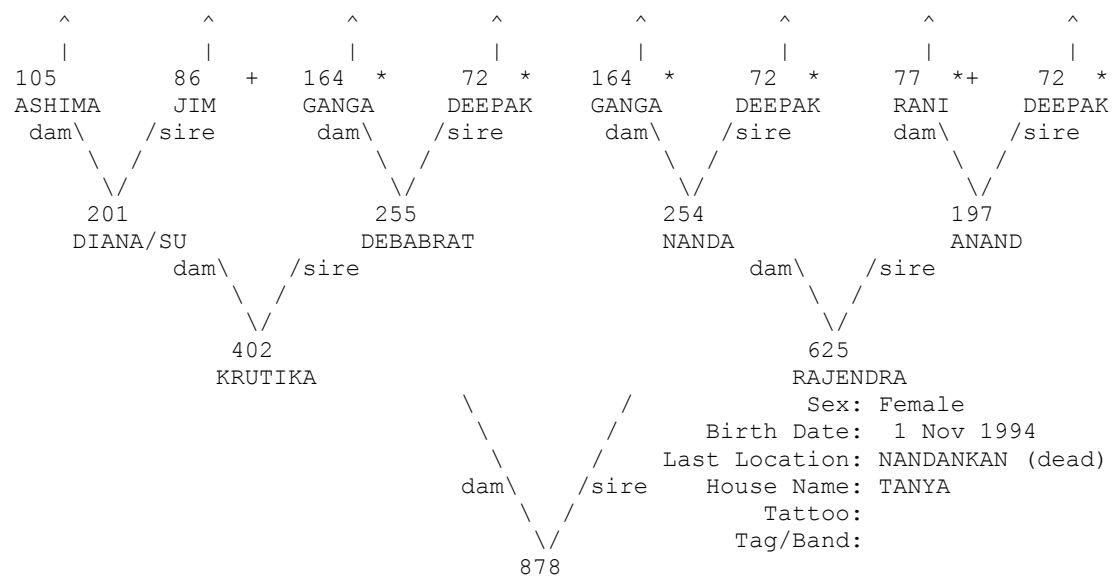

+ Wild-caught... * Appear more than once...
 ^ Pedigree continues beyond top of page...

=====
 Taxon Name: PANTHERA TIGRIS Studbook Number: 879
 =====

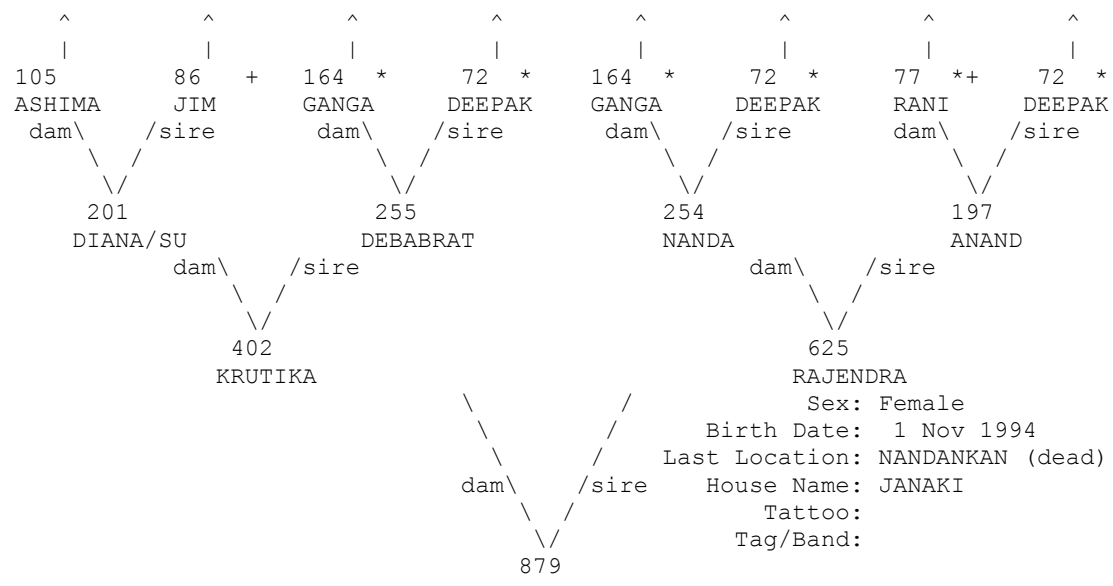

+ Wild-caught... * Appear more than once...
 ^ Pedigree continues beyond top of page...

=====

Taxon Name: PANTHERA TIGRIS Studbook Number: 880

=====

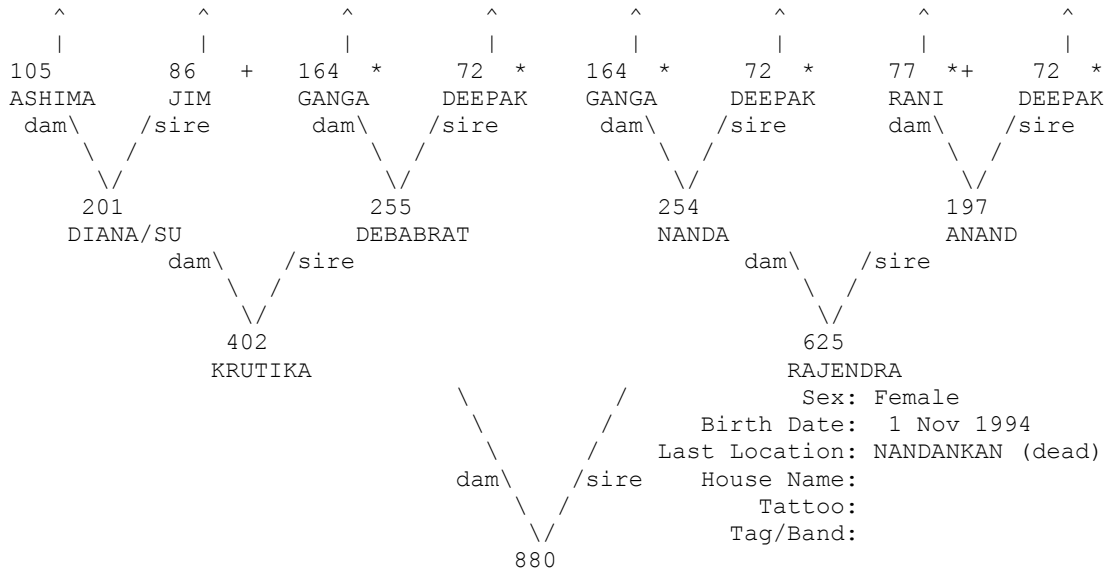

+ Wild-caught... * Appear more than once...
 ^ Pedigree continues beyond top of page...

=====

Taxon Name: PANTHERA TIGRIS Studbook Number: 881

=====

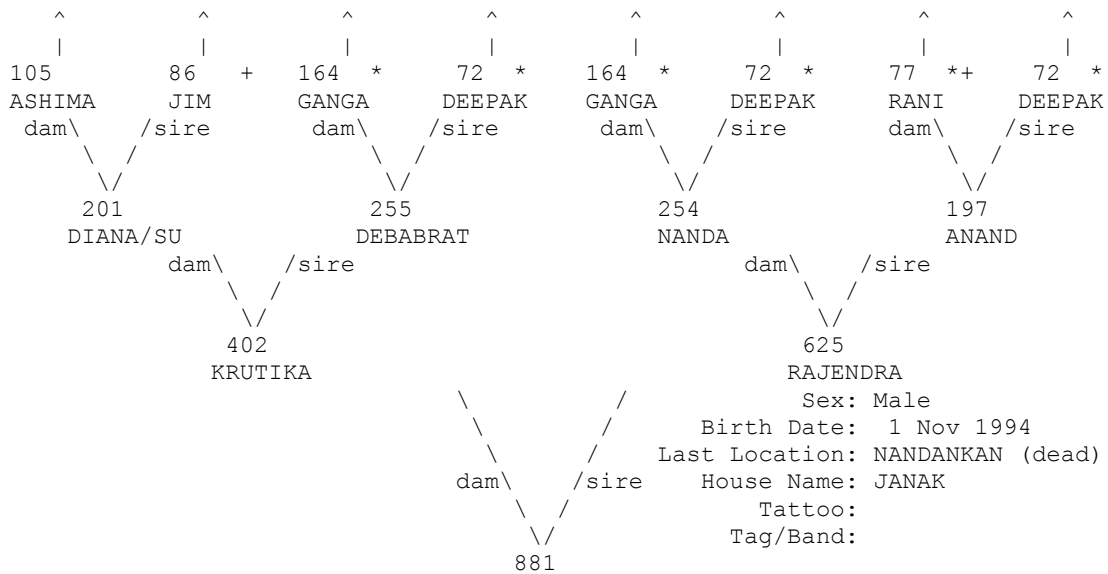

+ Wild-caught... * Appear more than once...
 ^ Pedigree continues beyond top of page...

=====
 Taxon Name: PANTHERA TIGRIS Studbook Number: 882
 =====

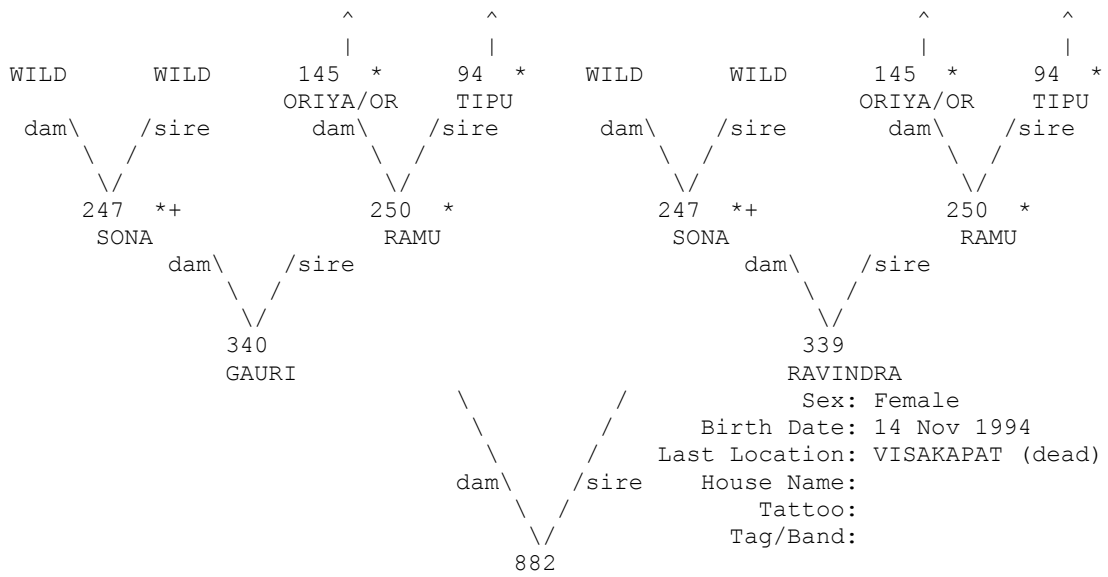

+ Wild-caught... * Appear more than once...
 ^ Pedigree continues beyond top of page...

=====
 Taxon Name: PANTHERA TIGRIS Studbook Number: 883
 =====

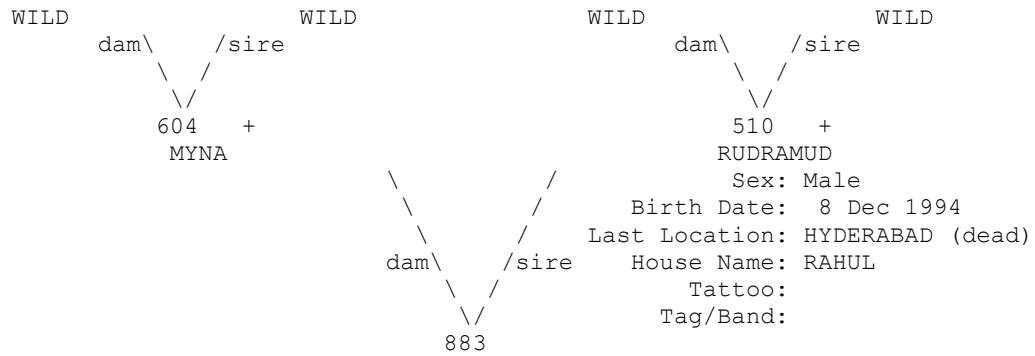

+ Wild-caught...

=====
 Taxon Name: PANTHERA TIGRIS Studbook Number: 884
 =====

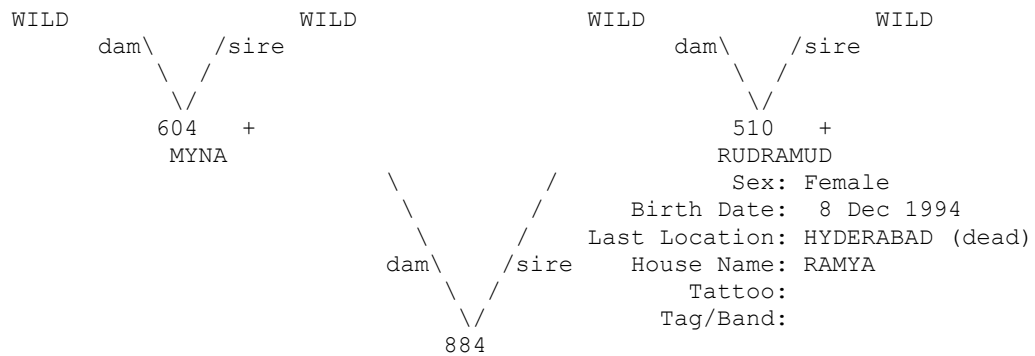

+ Wild-caught...

=====
 Taxon Name: PANTHERA TIGRIS Studbook Number: 885
 =====

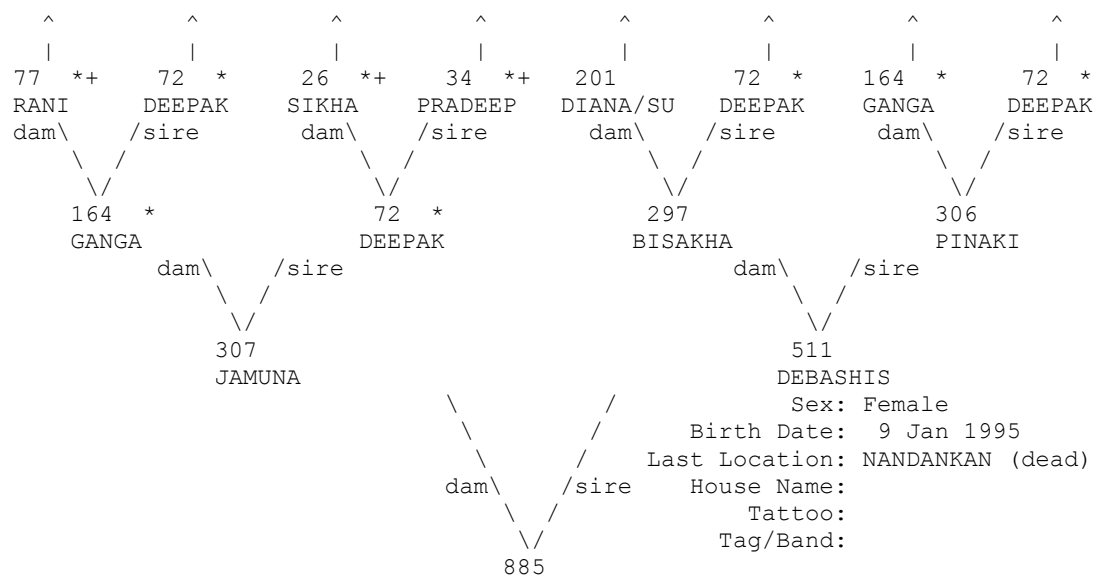

+ Wild-caught... * Appear more than once...
 ^ Pedigree continues beyond top of page...

=====
 Taxon Name: PANTHERA TIGRIS Studbook Number: 886
 =====

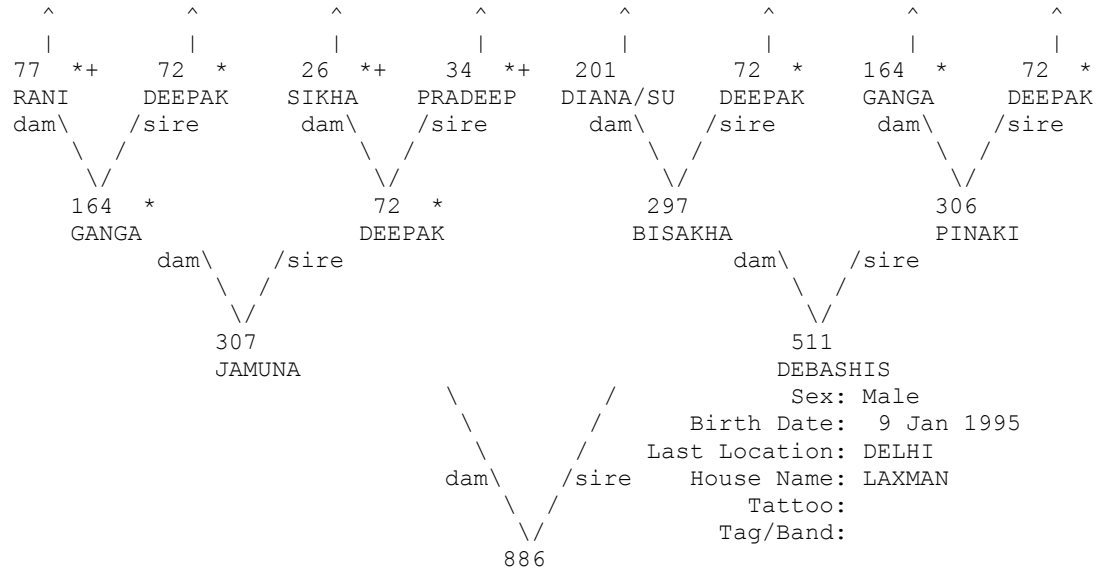

+ Wild-caught... * Appear more than once...
 ^ Pedigree continues beyond top of page...

=====
 Taxon Name: PANTHERA TIGRIS Studbook Number: 887
 =====

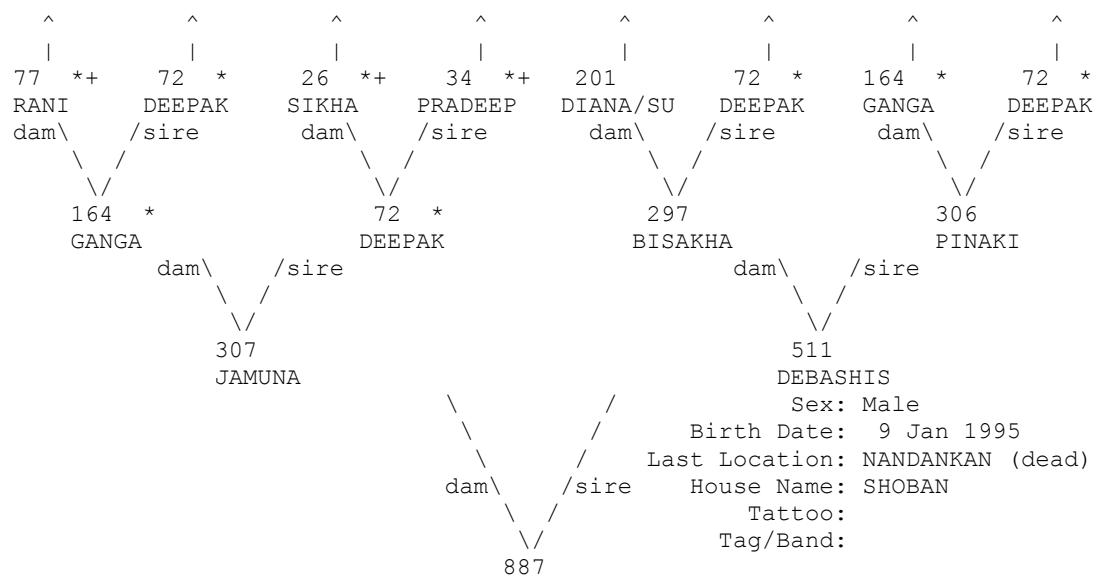

+ Wild-caught... * Appear more than once...
 ^ Pedigree continues beyond top of page...

=====
 Taxon Name: PANTHERA TIGRIS Studbook Number: 888
 =====

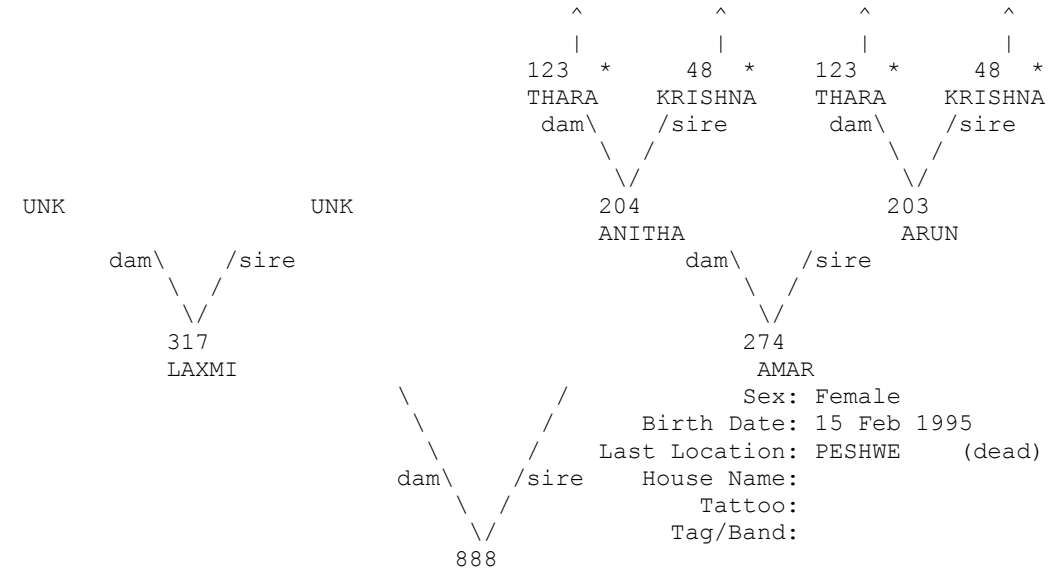

* Appear more than once...
 ^ Pedigree continues beyond top of page...

=====
 Taxon Name: PANTHERA TIGRIS Studbook Number: 889
 =====

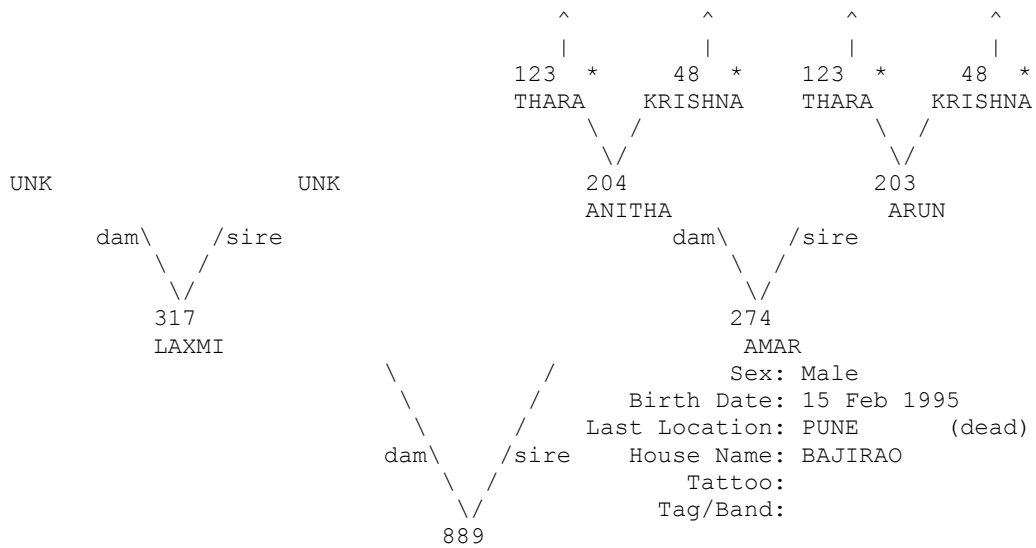

* Appear more than once...
 ^ Pedigree continues beyond top of page...

=====
 Taxon Name: PANTHERA TIGRIS Studbook Number: 890
 =====

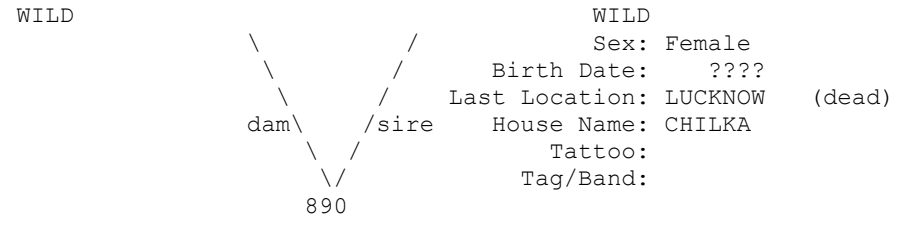

=====
 Taxon Name: PANTHERA TIGRIS Studbook Number: 891
 =====

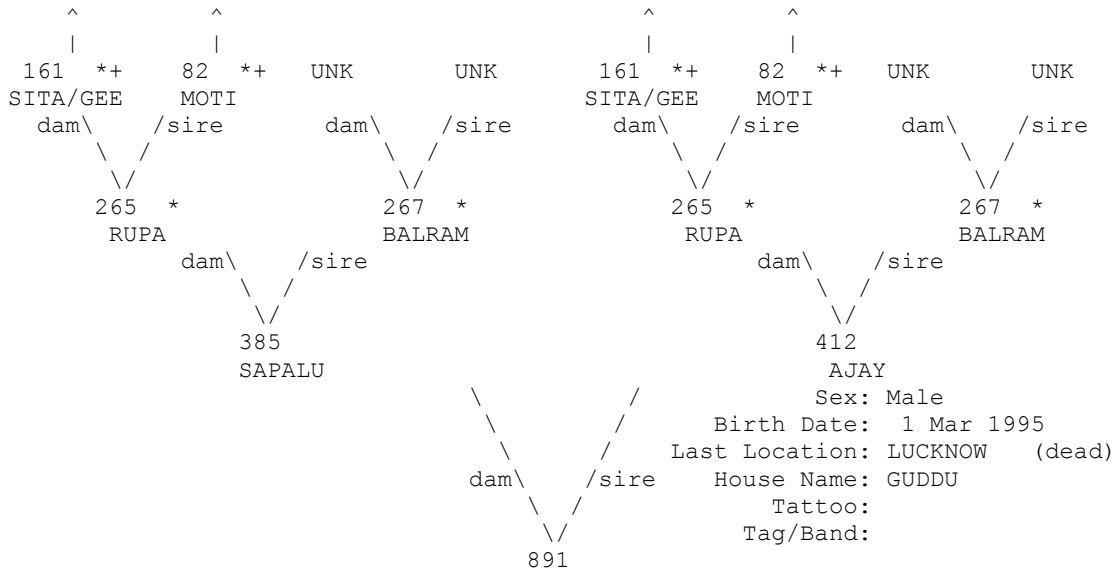

+ Wild-caught... * Appear more than once...
 ^ Pedigree continues beyond top of page...

=====
 Taxon Name: PANTHERA TIGRIS Studbook Number: 892
 =====

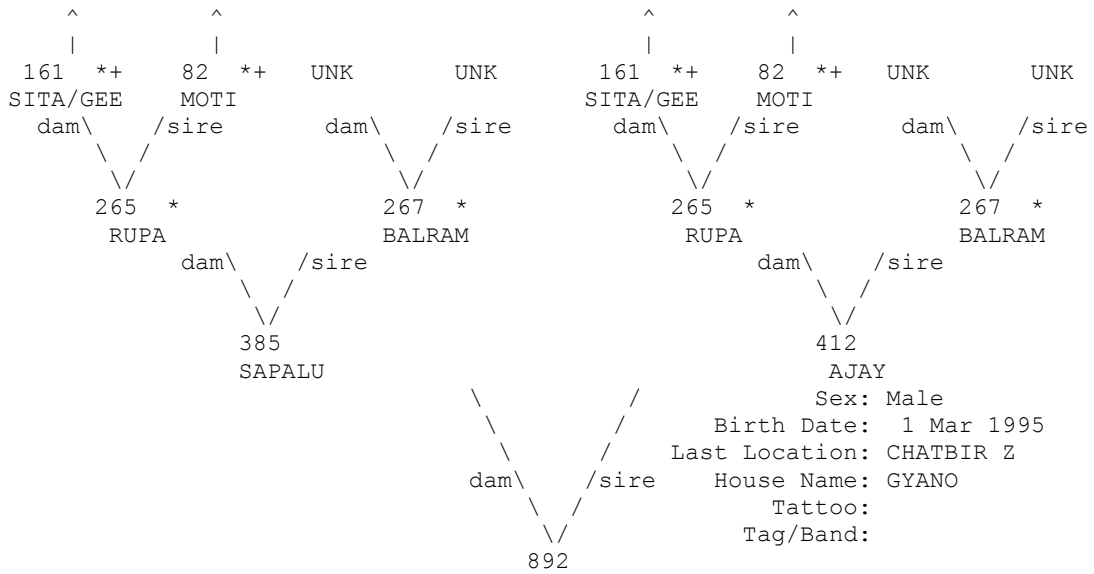

+ Wild-caught... * Appear more than once...
 ^ Pedigree continues beyond top of page...

=====
 Taxon Name: PANTHERA TIGRIS Studbook Number: 893
 =====

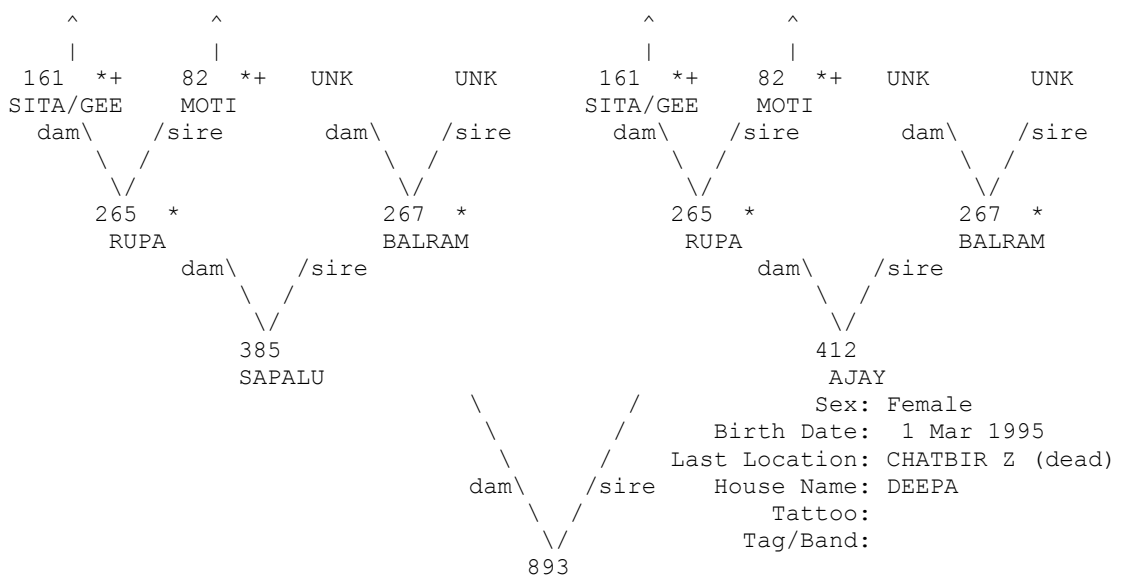

+ Wild-caught... * Appear more than once...
 ^ Pedigree continues beyond top of page...

=====
 Taxon Name: PANTHERA TIGRIS Studbook Number: 894
 =====

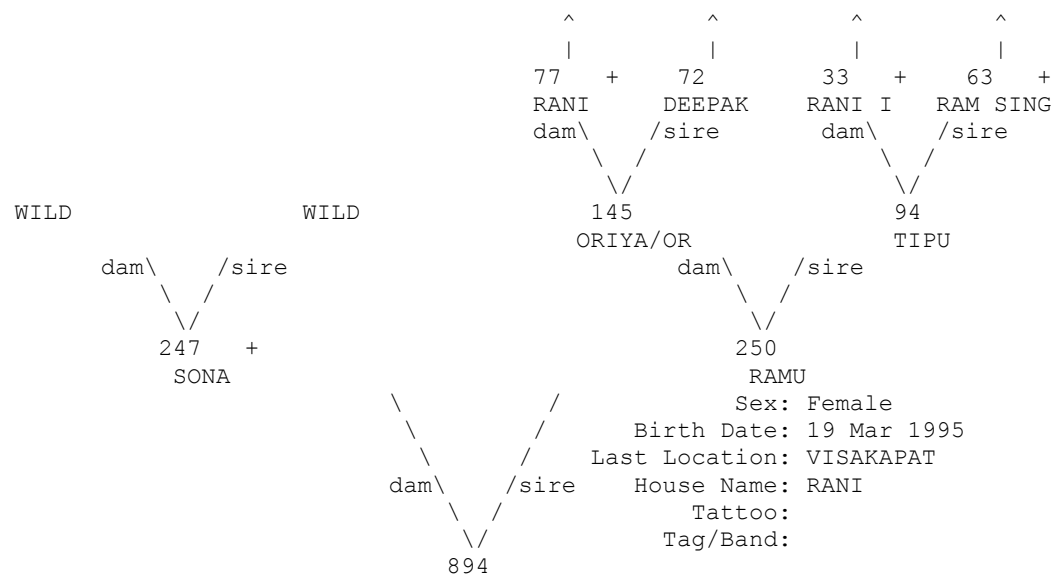

+ Wild-caught...
 ^ Pedigree continues beyond top of page...

=====
Taxon Name: PANTHERA TIGRIS Studbook Number: 895
=====

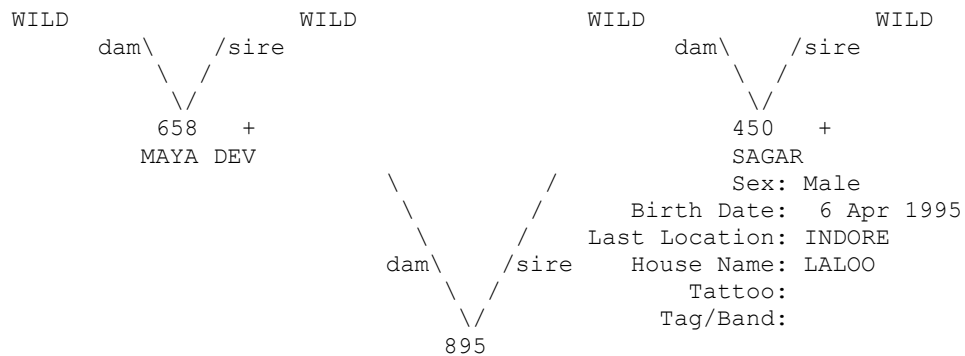

+ Wild-caught...

=====
Taxon Name: PANTHERA TIGRIS Studbook Number: 896
=====

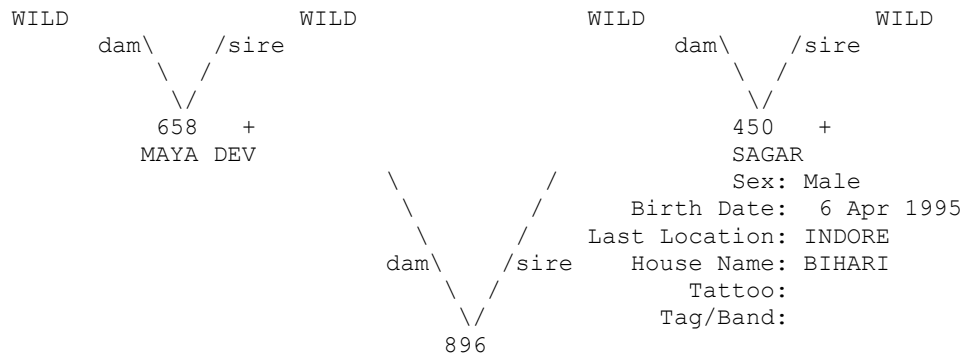

+ Wild-caught...

=====
Taxon Name: PANTHERA TIGRIS Studbook Number: 897
=====

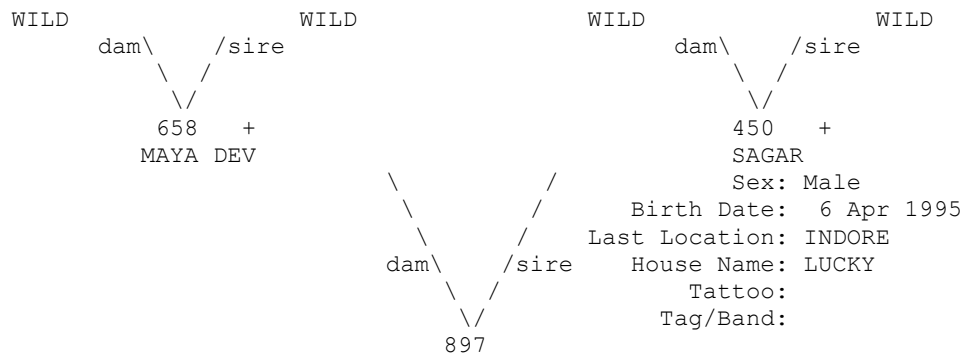

+ Wild-caught...

=====
 Taxon Name: PANTHERA TIGRIS Studbook Number: 898
 =====

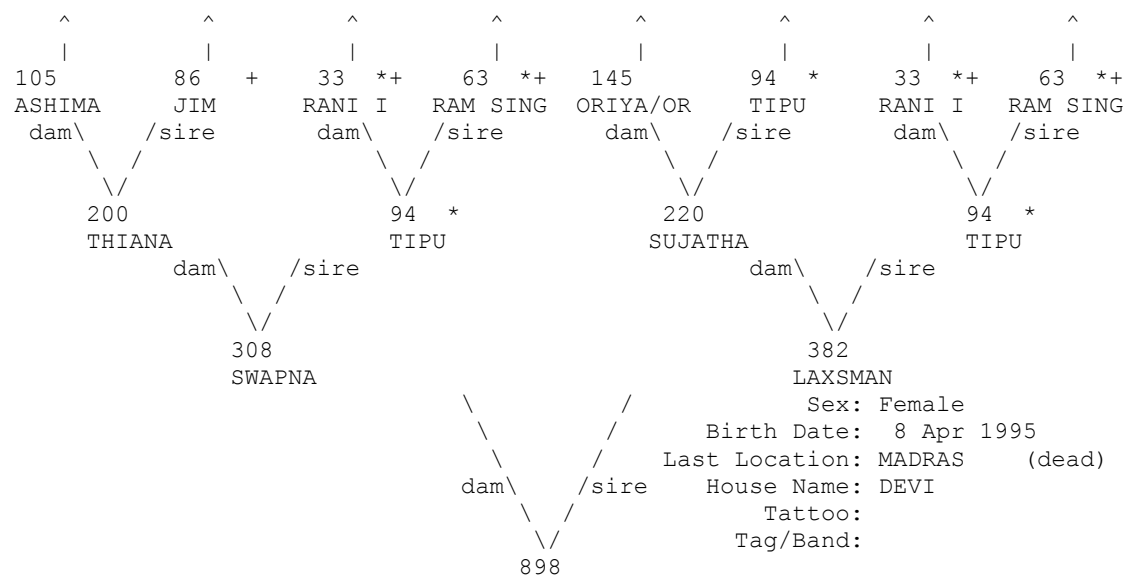

+ Wild-caught... * Appear more than once...
 ^ Pedigree continues beyond top of page...

=====
 Taxon Name: PANTHERA TIGRIS Studbook Number: 899
 =====

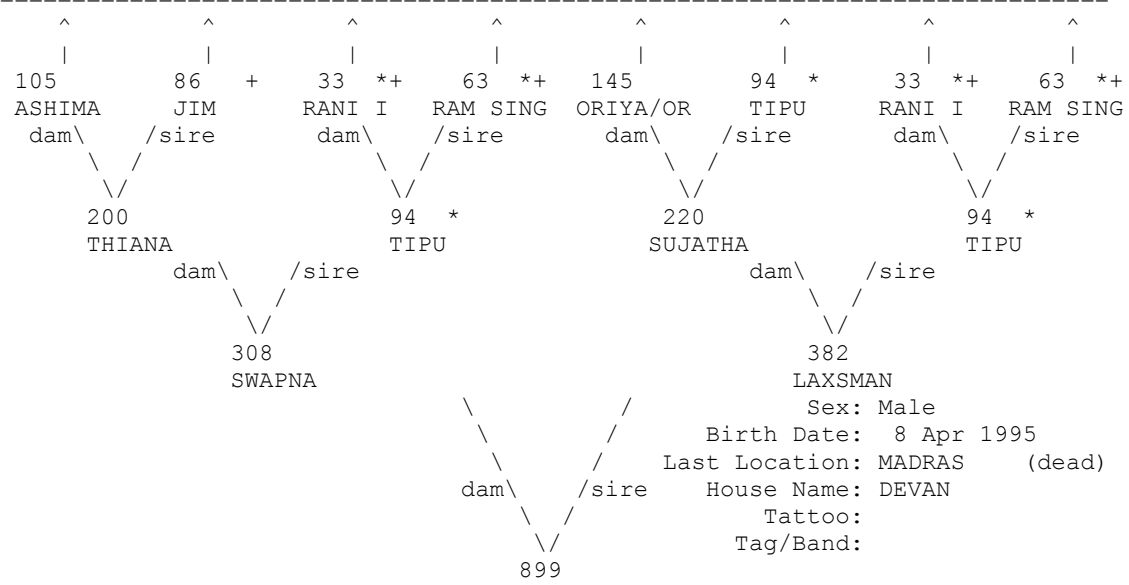

+ Wild-caught... * Appear more than once...
 ^ Pedigree continues beyond top of page...

=====
 Taxon Name: PANTHERA TIGRIS Studbook Number: 900
 =====

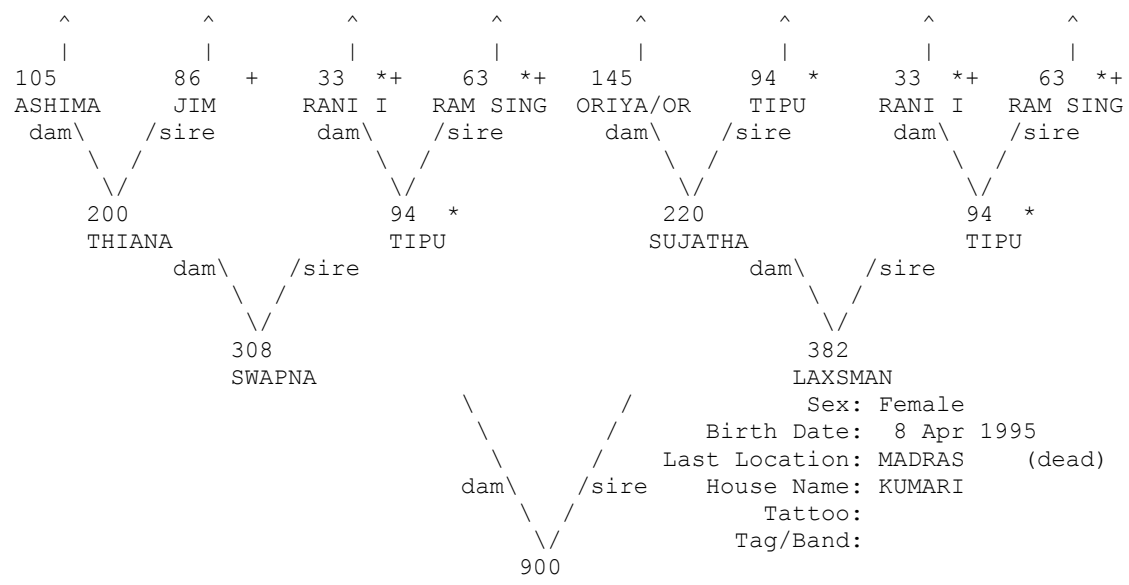

+ Wild-caught... * Appear more than once...
 ^ Pedigree continues beyond top of page...

=====
 Taxon Name: PANTHERA TIGRIS Studbook Number: 901
 =====

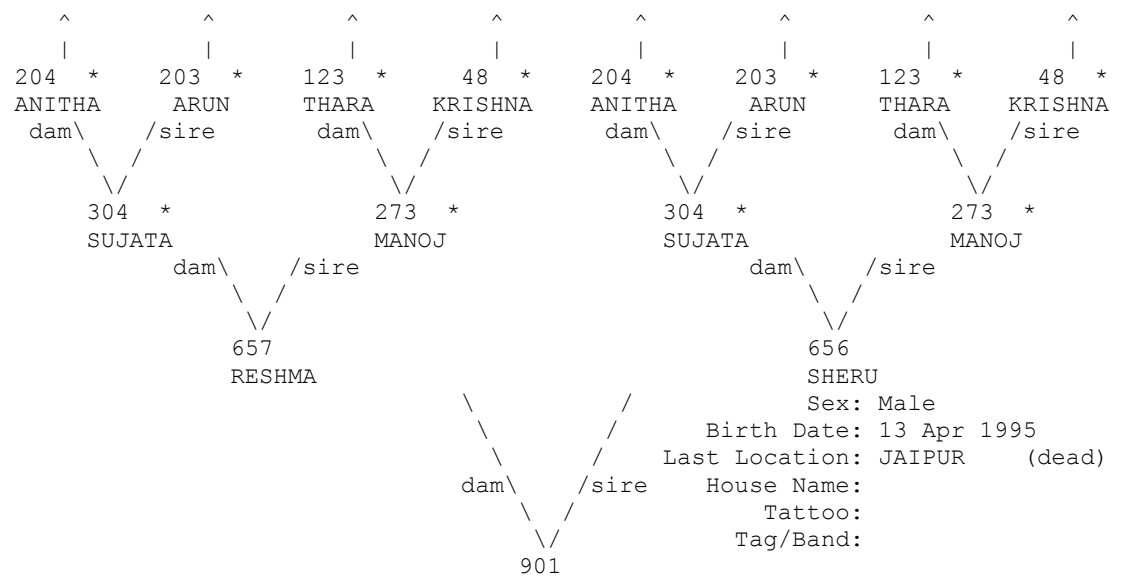

* Appear more than once...
 ^ Pedigree continues beyond top of page...

=====
 Taxon Name: PANTHERA TIGRIS Studbook Number: 902
 =====

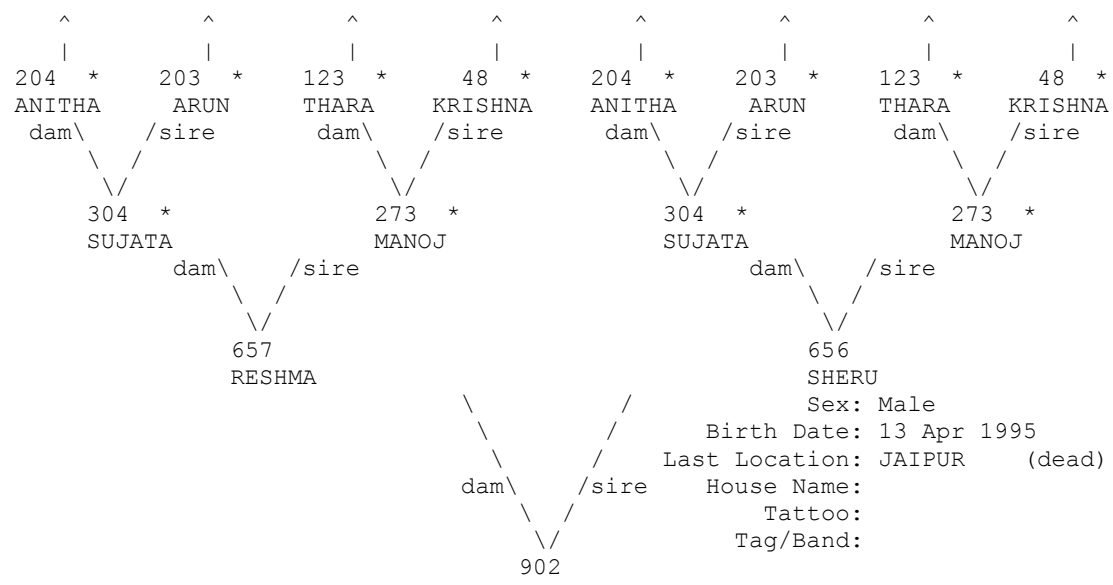

* Appear more than once...
 ^ Pedigree continues beyond top of page...

=====
 Taxon Name: PANTHERA TIGRIS Studbook Number: 903
 =====

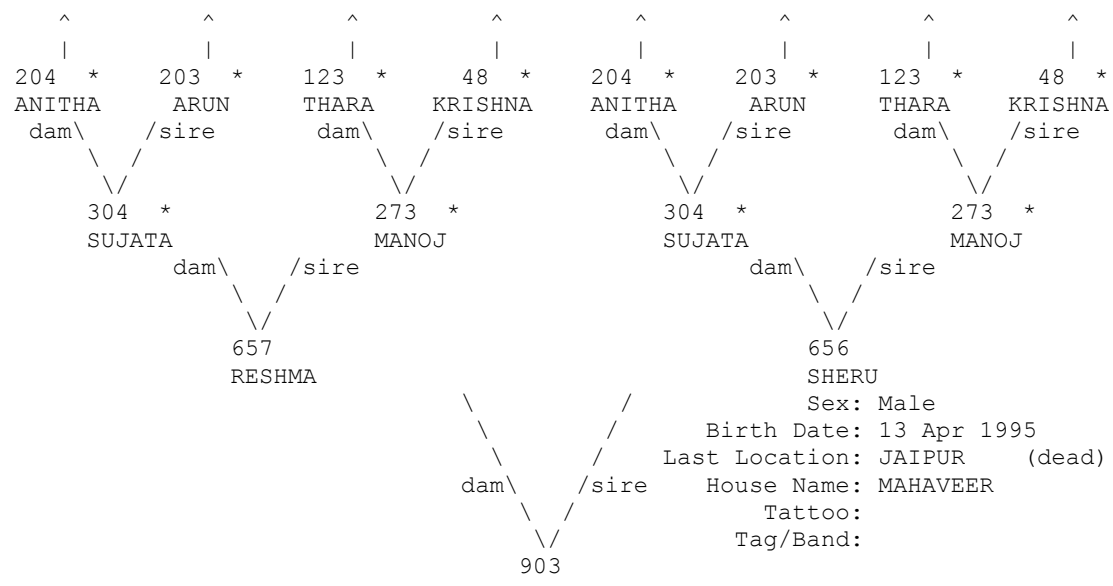

* Appear more than once...
 ^ Pedigree continues beyond top of page...

=====
 Taxon Name: PANTHERA TIGRIS Studbook Number: 904
 =====

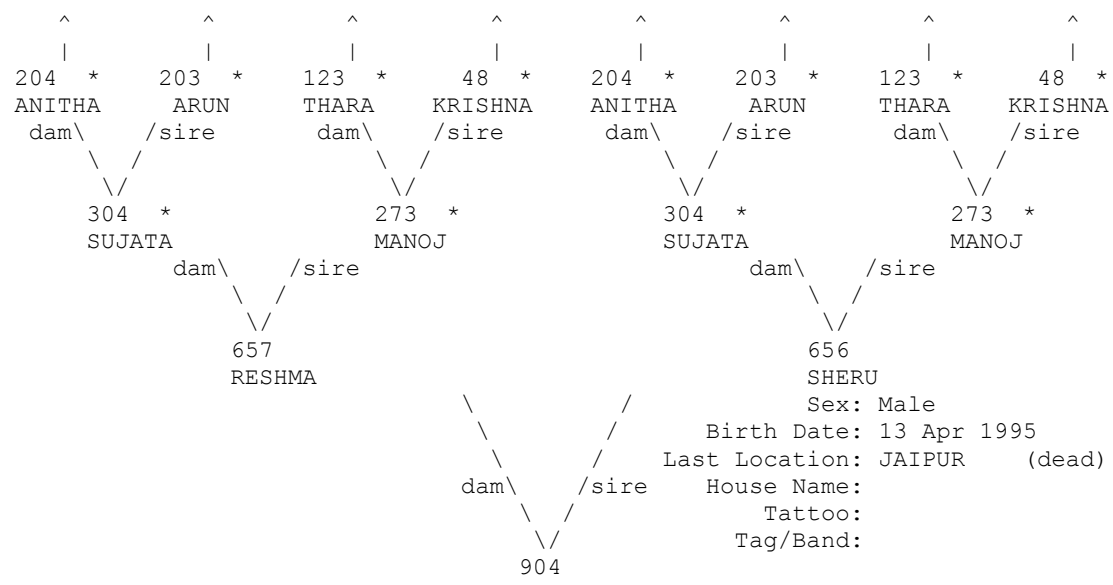

* Appear more than once...
 ^ Pedigree continues beyond top of page...

=====
 Taxon Name: PANTHERA TIGRIS Studbook Number: 905
 =====

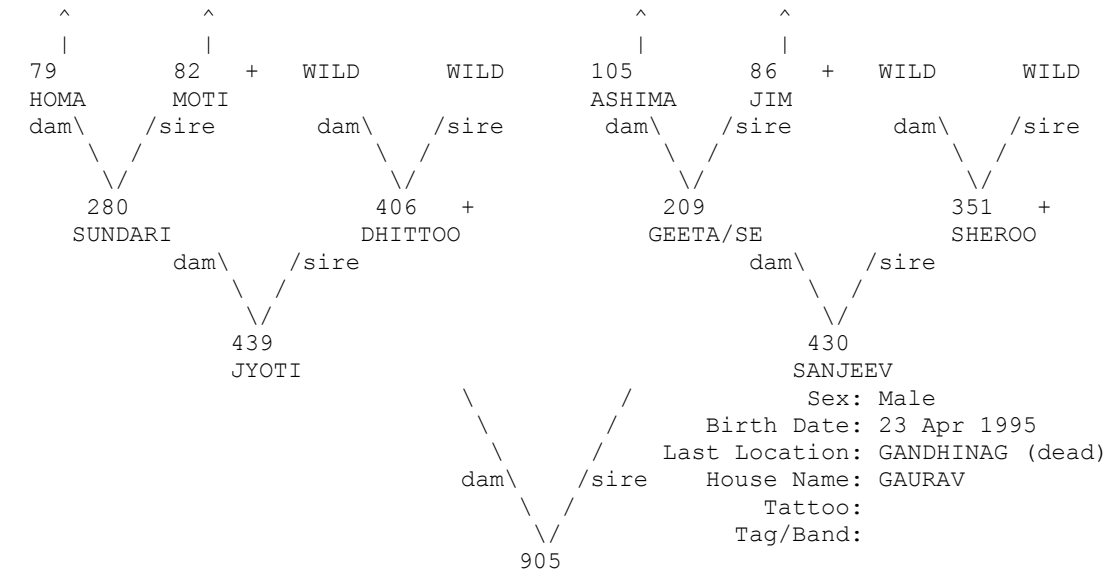

+ Wild-caught... * Appear more than once...
 ^ Pedigree continues beyond top of page...

=====
 Taxon Name: PANTHERA TIGRIS Studbook Number: 906
 =====

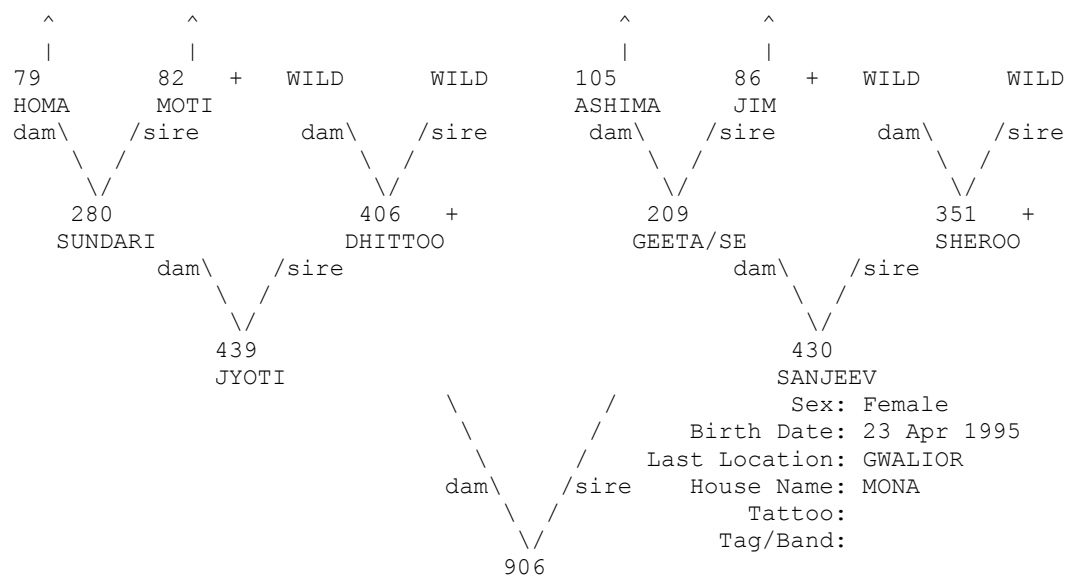

+ Wild-caught... * Appear more than once...
 ^ Pedigree continues beyond top of page...

=====
 Taxon Name: PANTHERA TIGRIS Studbook Number: 907
 =====

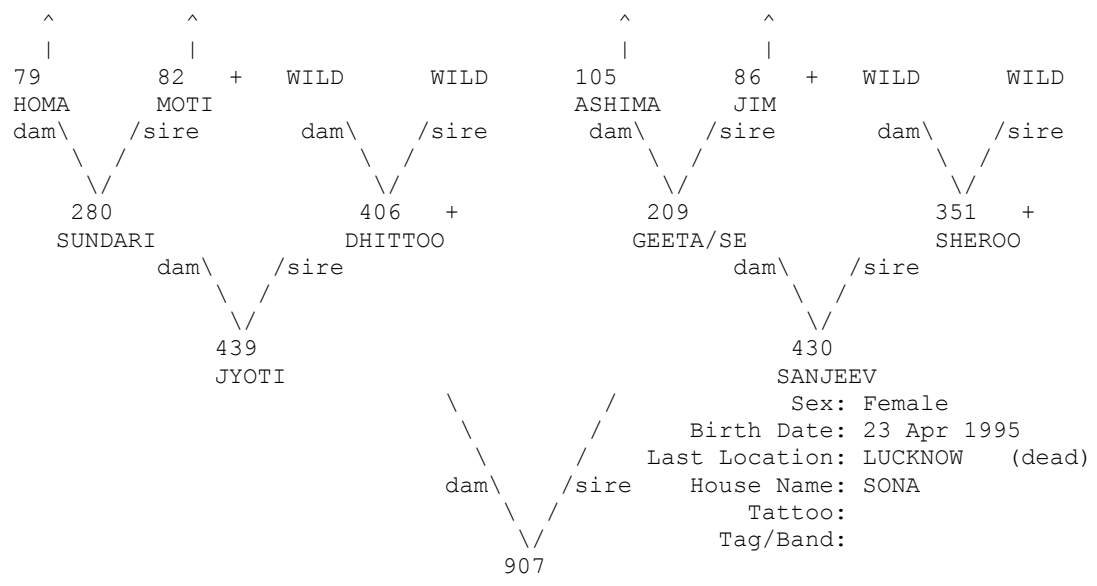

+ Wild-caught... * Appear more than once...
 ^ Pedigree continues beyond top of page...

=====
 Taxon Name: PANTHERA TIGRIS Studbook Number: 908
 =====

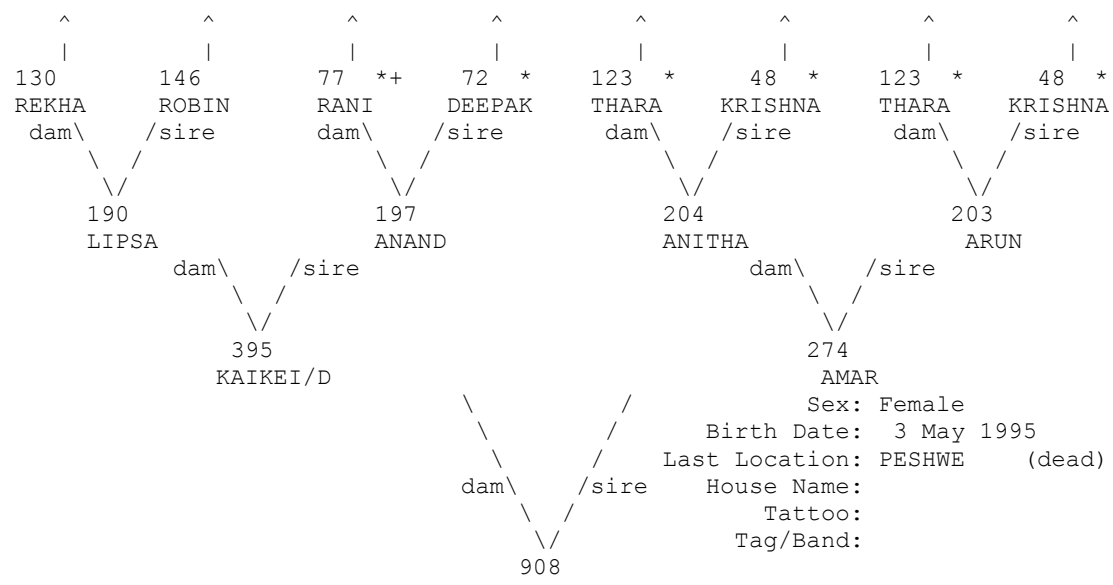

+ Wild-caught... * Appear more than once...
 ^ Pedigree continues beyond top of page...

=====
 Taxon Name: PANTHERA TIGRIS Studbook Number: 909
 =====

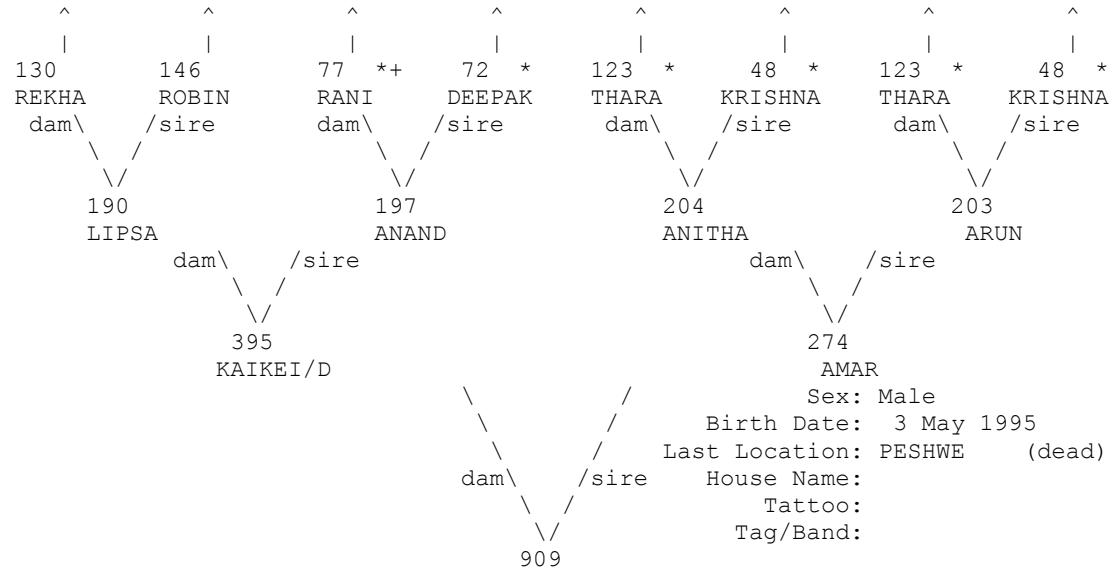

+ Wild-caught... * Appear more than once...
 ^ Pedigree continues beyond top of page...

=====
 Taxon Name: PANTHERA TIGRIS Studbook Number: 910
 =====

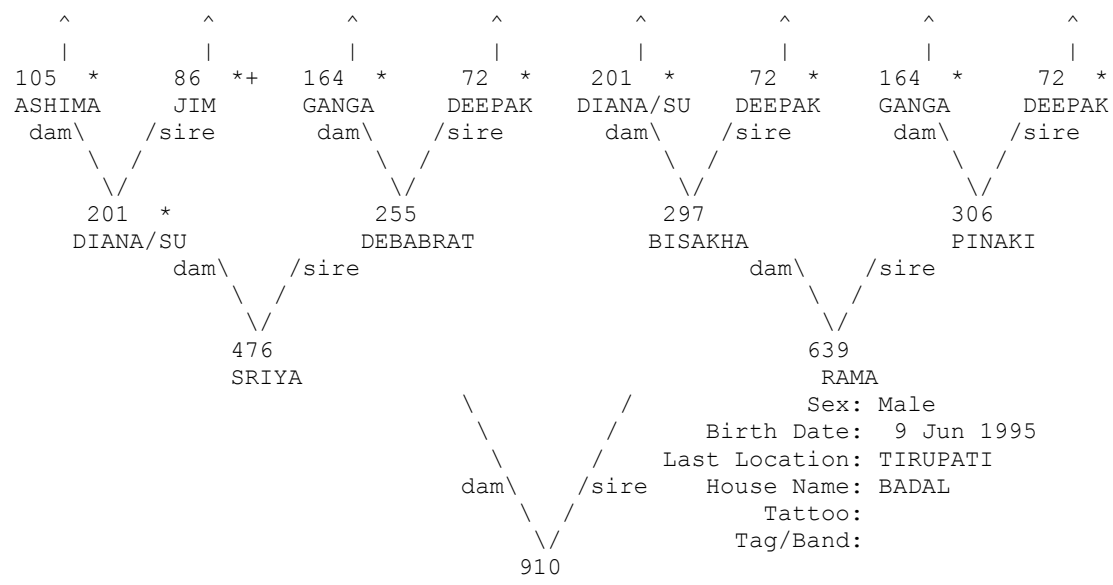

+ Wild-caught... * Appear more than once...
 ^ Pedigree continues beyond top of page...

=====
 Taxon Name: PANTHERA TIGRIS Studbook Number: 911
 =====

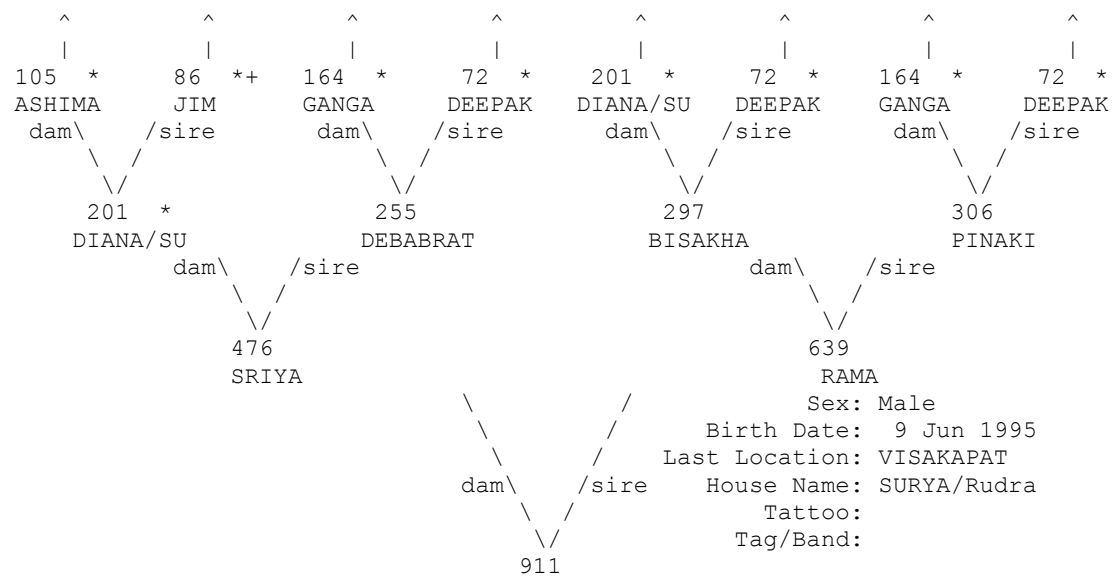

+ Wild-caught... * Appear more than once...
 ^ Pedigree continues beyond top of page...

=====
 Taxon Name: PANTHERA TIGRIS Studbook Number: 912
 =====

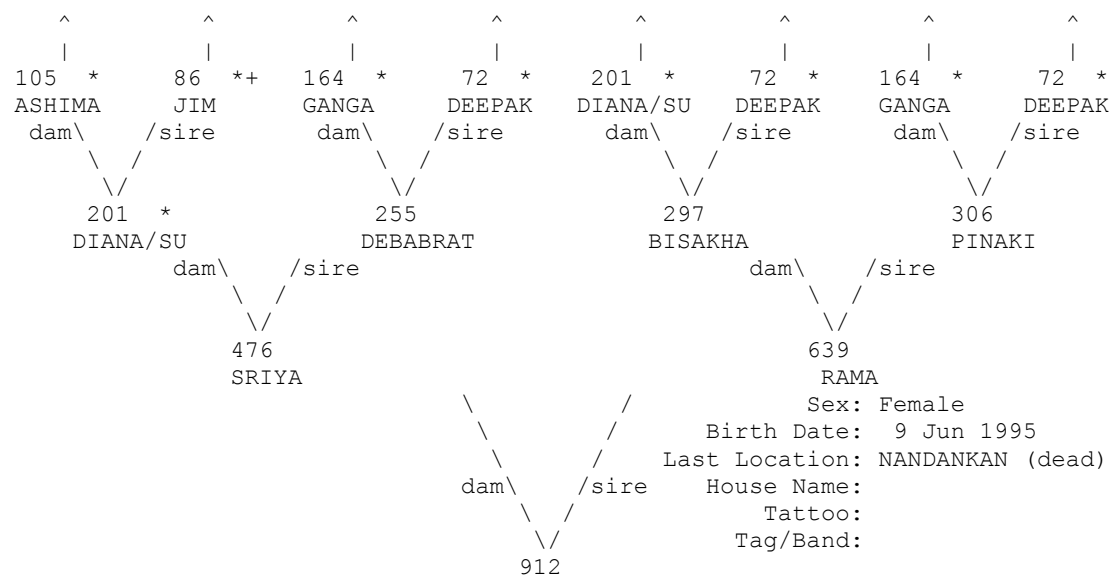

+ Wild-caught... * Appear more than once...
 ^ Pedigree continues beyond top of page...

=====
 Taxon Name: PANTHERA TIGRIS Studbook Number: 913
 =====

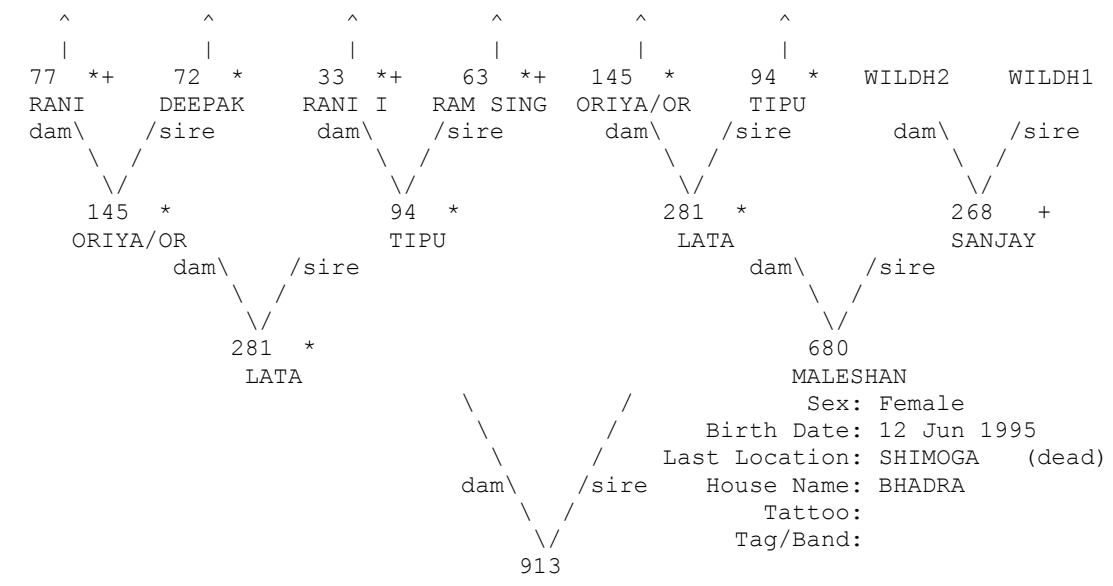

+ Wild-caught... * Appear more than once...
 ^ Pedigree continues beyond top of page...

=====
 Taxon Name: PANTHERA TIGRIS Studbook Number: 914
 =====

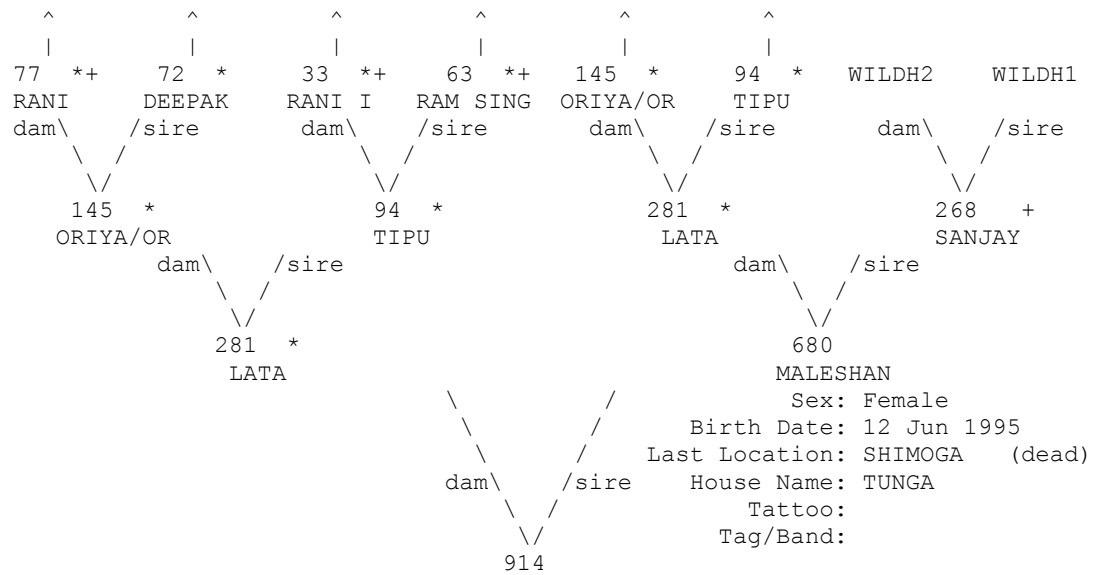

+ Wild-caught... * Appear more than once...
 ^ Pedigree continues beyond top of page...

=====
 Taxon Name: PANTHERA TIGRIS Studbook Number: 915
 =====

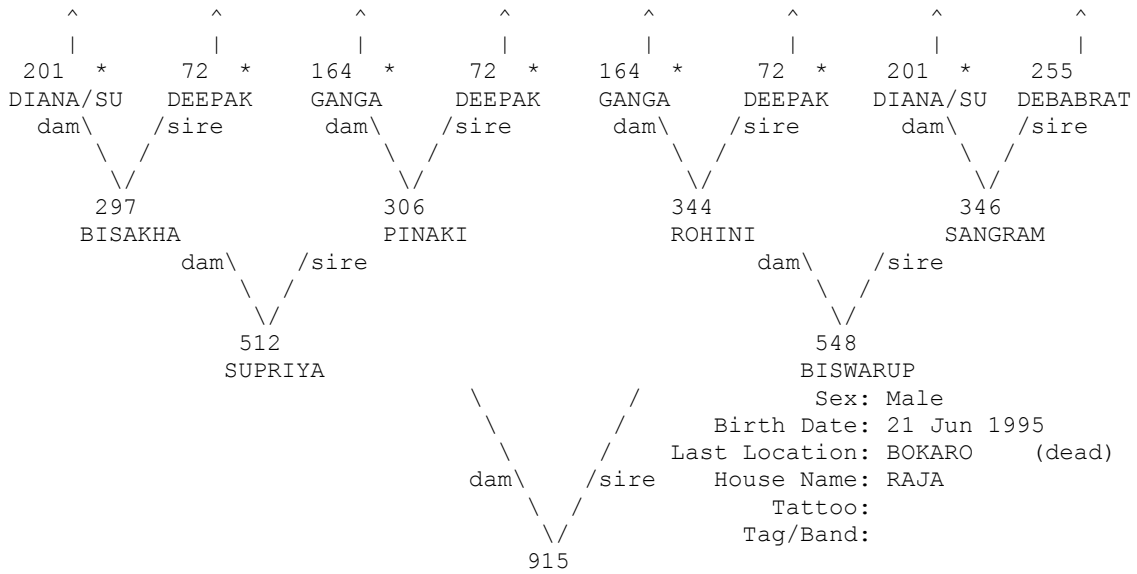

* Appear more than once...
 ^ Pedigree continues beyond top of page...

=====
 Taxon Name: PANTHERA TIGRIS Studbook Number: 916
 =====

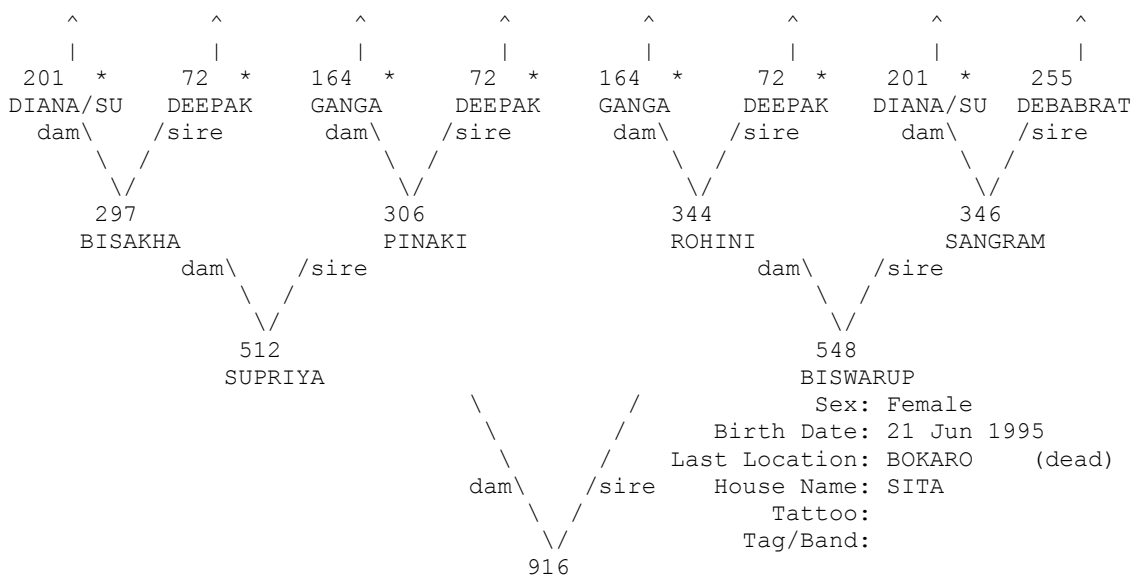

* Appear more than once...
 ^ Pedigree continues beyond top of page...

=====
 Taxon Name: PANTHERA TIGRIS Studbook Number: 917
 =====

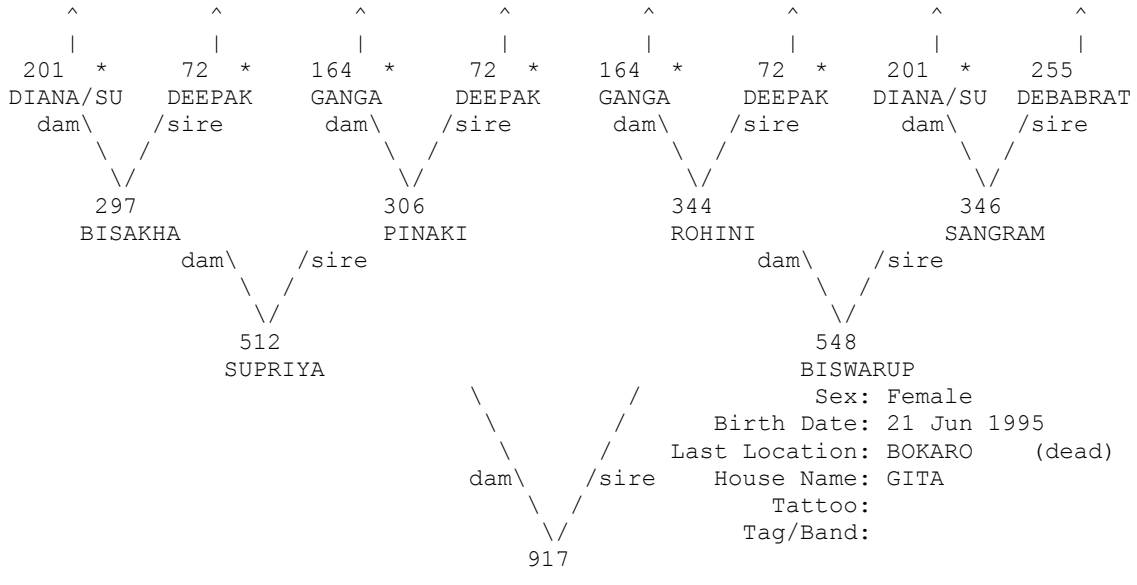

* Appear more than once...
 ^ Pedigree continues beyond top of page...

=====
Taxon Name: PANTHERA TIGRIS Studbook Number: 918
=====

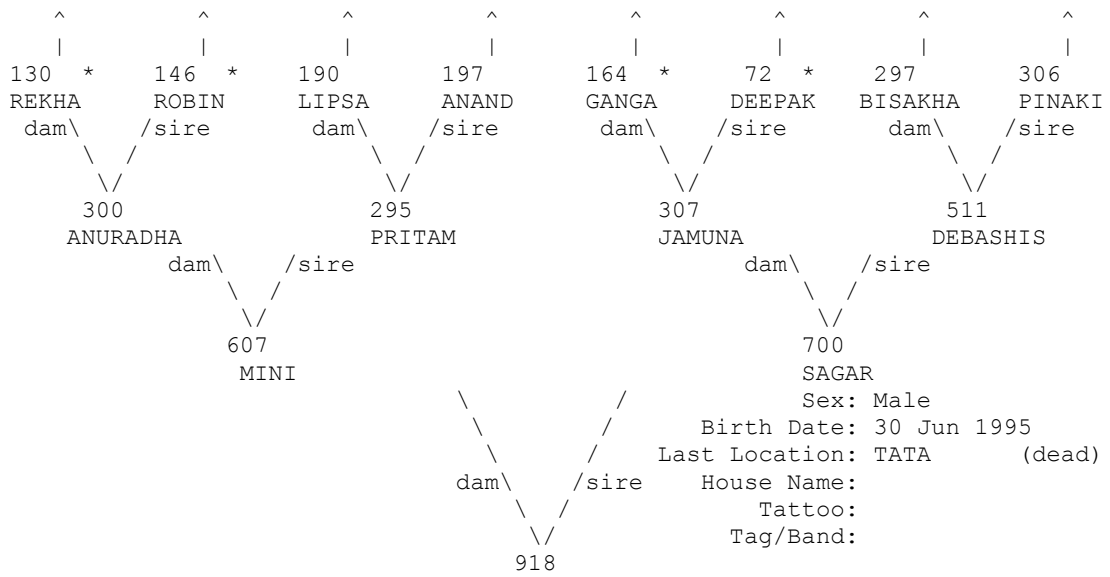

* Appear more than once...
^ Pedigree continues beyond top of page...

=====
Taxon Name: PANTHERA TIGRIS Studbook Number: 919
=====

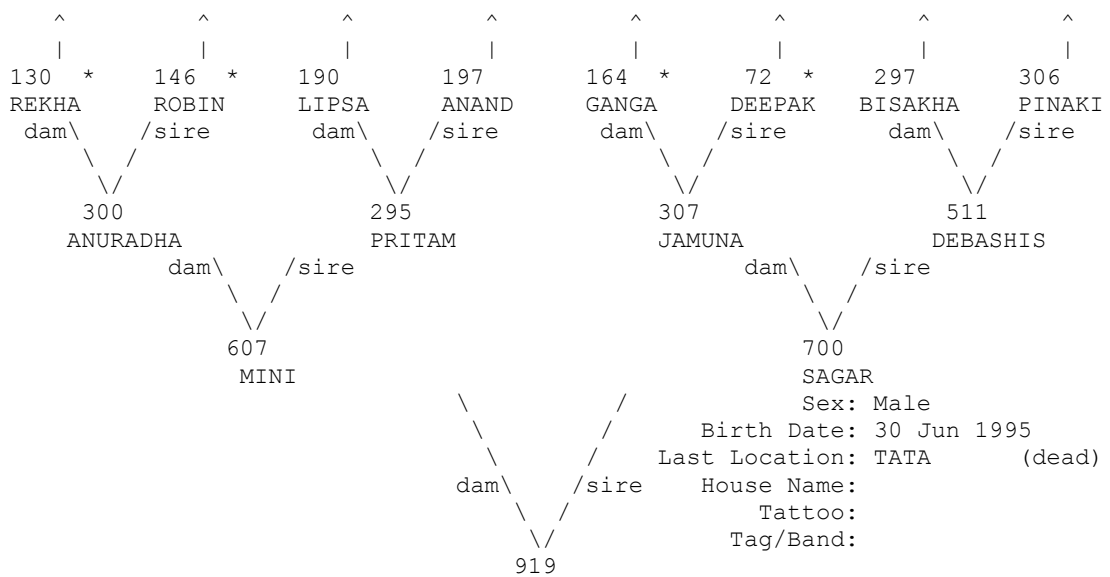

* Appear more than once...
^ Pedigree continues beyond top of page...

=====
 Taxon Name: PANTHERA TIGRIS Studbook Number: 920
 =====

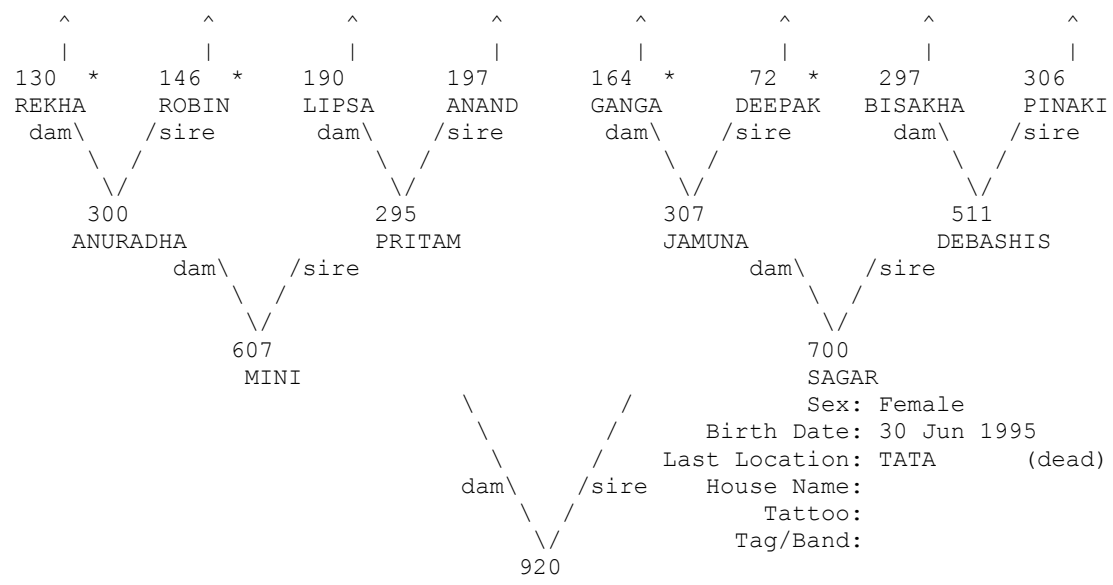

* Appear more than once...
 ^ Pedigree continues beyond top of page...

=====
 Taxon Name: PANTHERA TIGRIS Studbook Number: 921
 =====

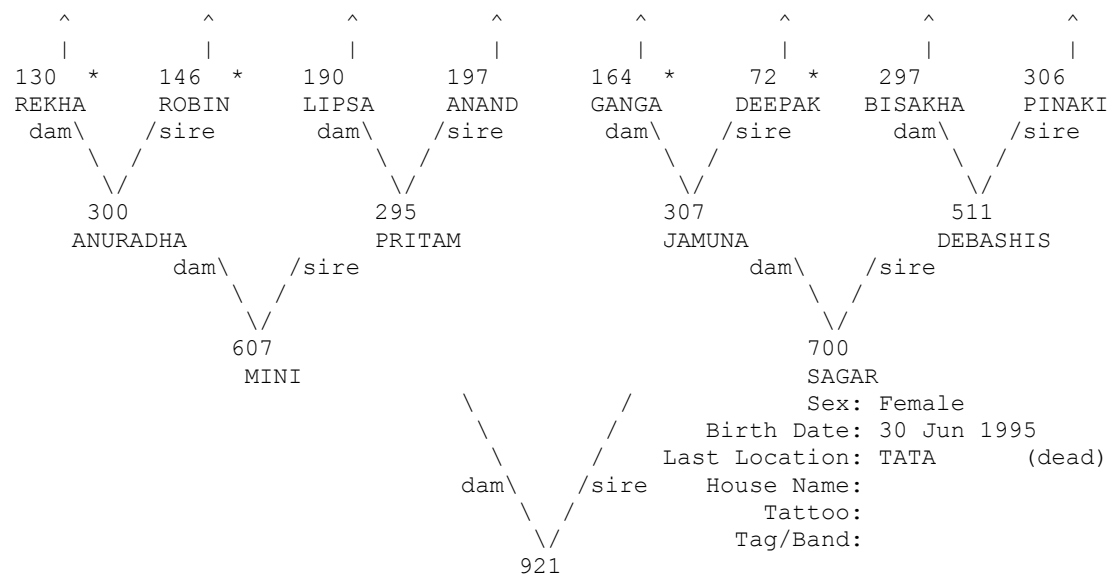

* Appear more than once...
 ^ Pedigree continues beyond top of page...

=====
 Taxon Name: PANTHERA TIGRIS Studbook Number: 922
 =====

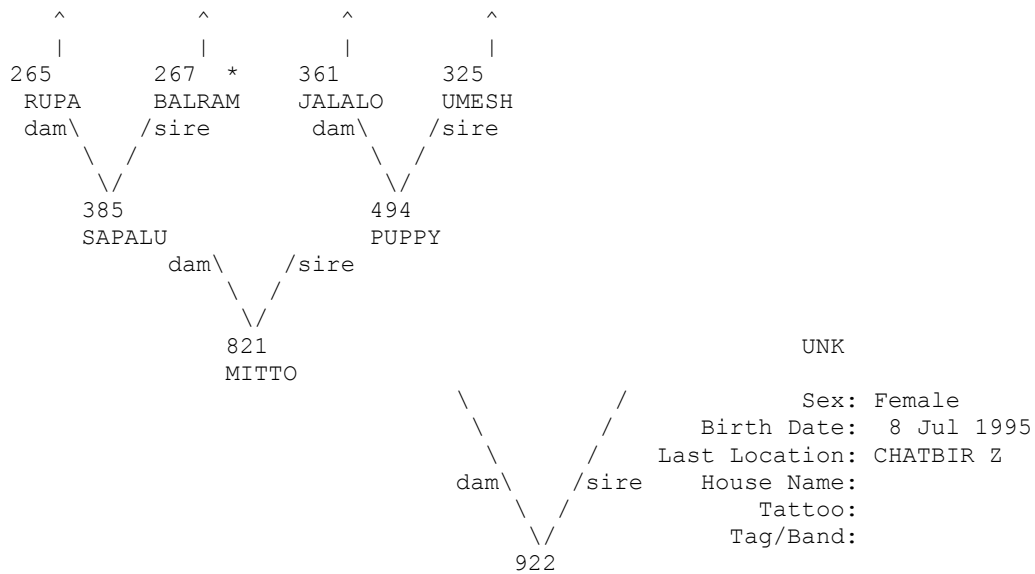

* Appear more than once...
 ^ Pedigree continues beyond top of page...

=====
 Taxon Name: PANTHERA TIGRIS Studbook Number: 923
 =====

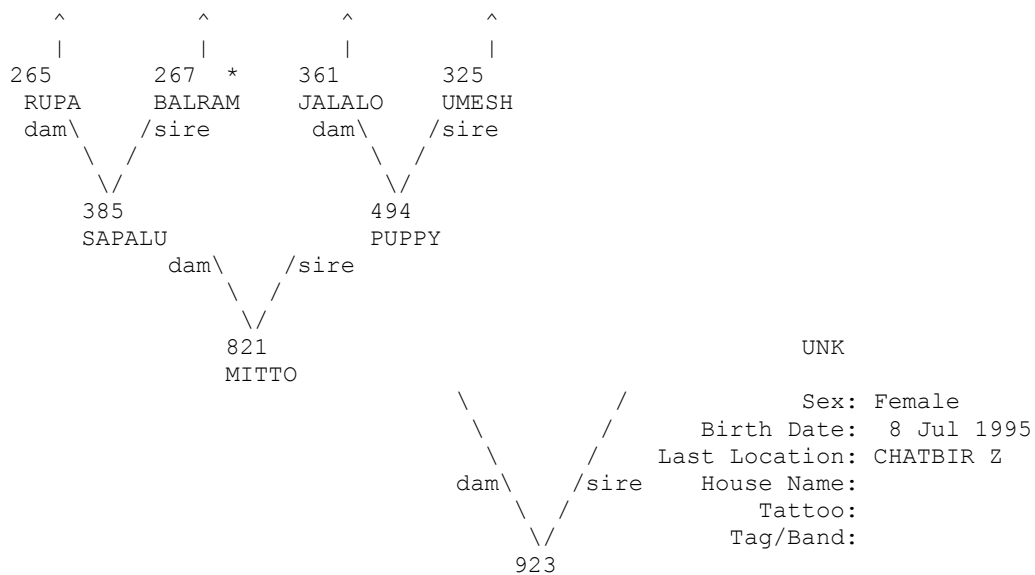

* Appear more than once...
 ^ Pedigree continues beyond top of page...

=====
 Taxon Name: PANTHERA TIGRIS Studbook Number: 926
 =====

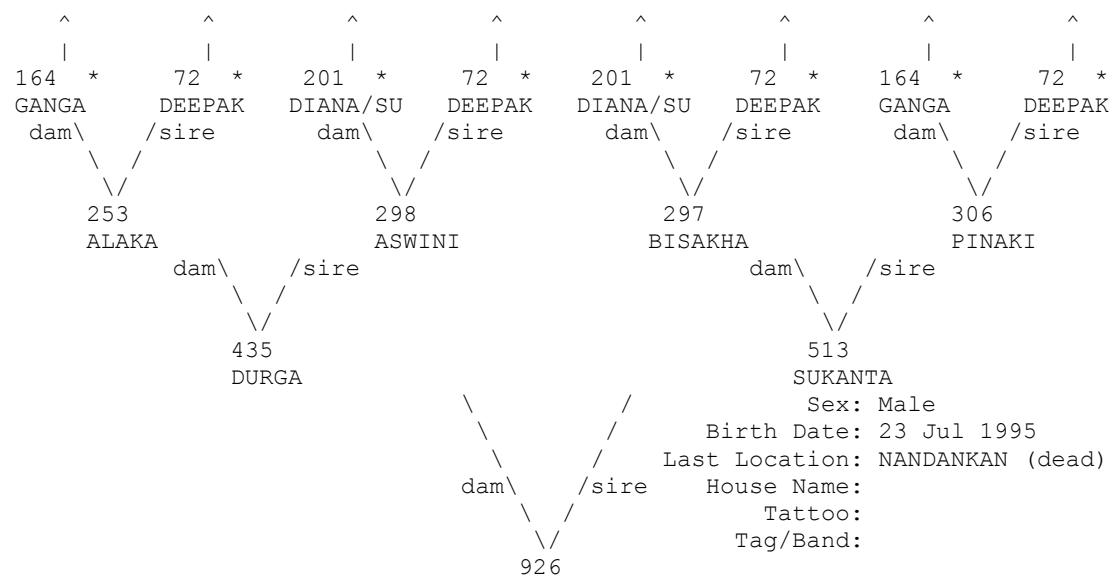

* Appear more than once...
 ^ Pedigree continues beyond top of page...

=====
 Taxon Name: PANTHERA TIGRIS Studbook Number: 927
 =====

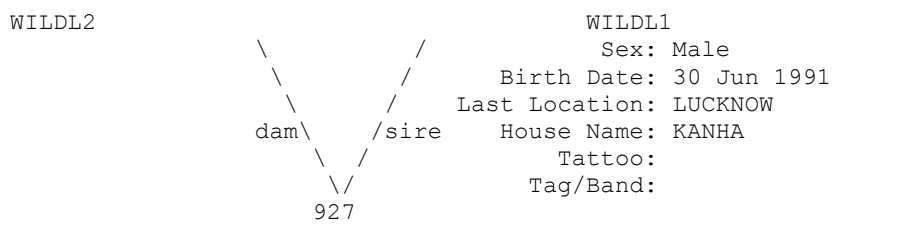

=====
 Taxon Name: PANTHERA TIGRIS Studbook Number: 928
 =====

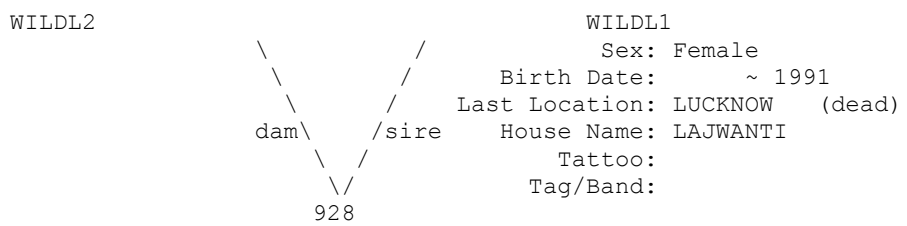

=====
 Taxon Name: PANTHERA TIGRIS Studbook Number: 929
 =====

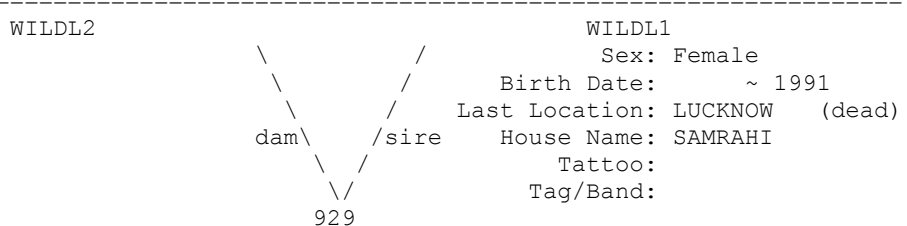

=====
 Taxon Name: PANTHERA TIGRIS Studbook Number: 930
 =====

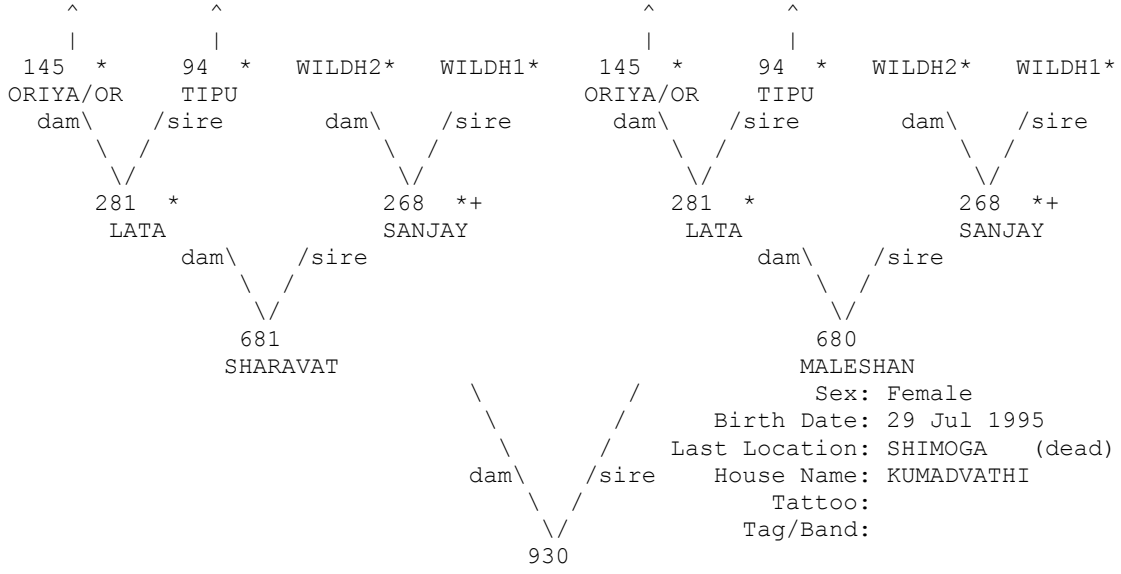

+ Wild-caught... * Appear more than once...
 ^ Pedigree continues beyond top of page...

=====
 Taxon Name: PANTHERA TIGRIS Studbook Number: 931
 =====

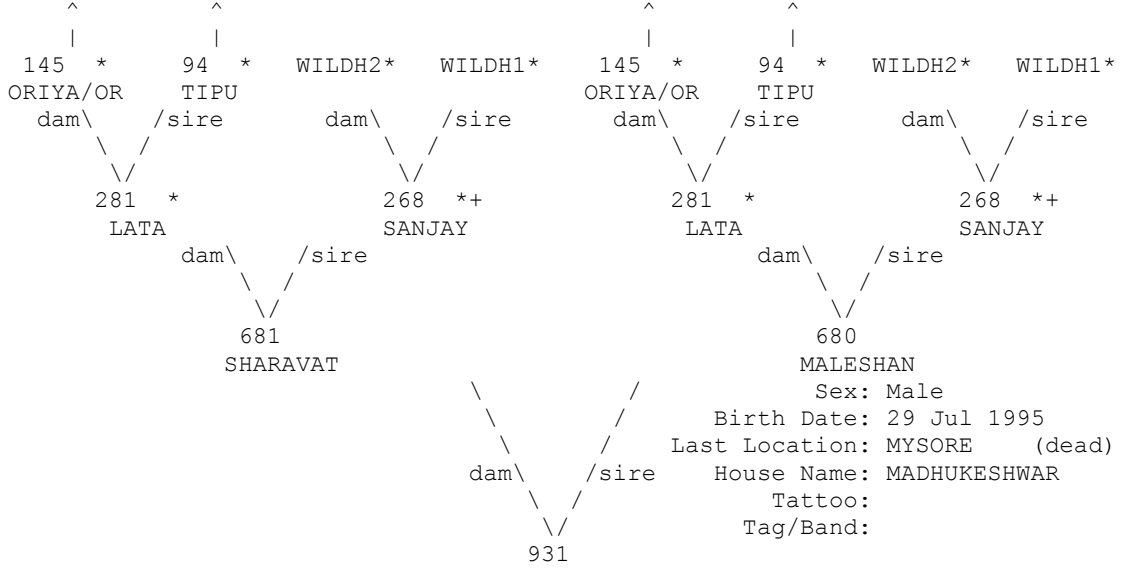

+ Wild-caught... * Appear more than once...
 ^ Pedigree continues beyond top of page...

=====
 Taxon Name: PANTHERA TIGRIS Studbook Number: 932
 =====

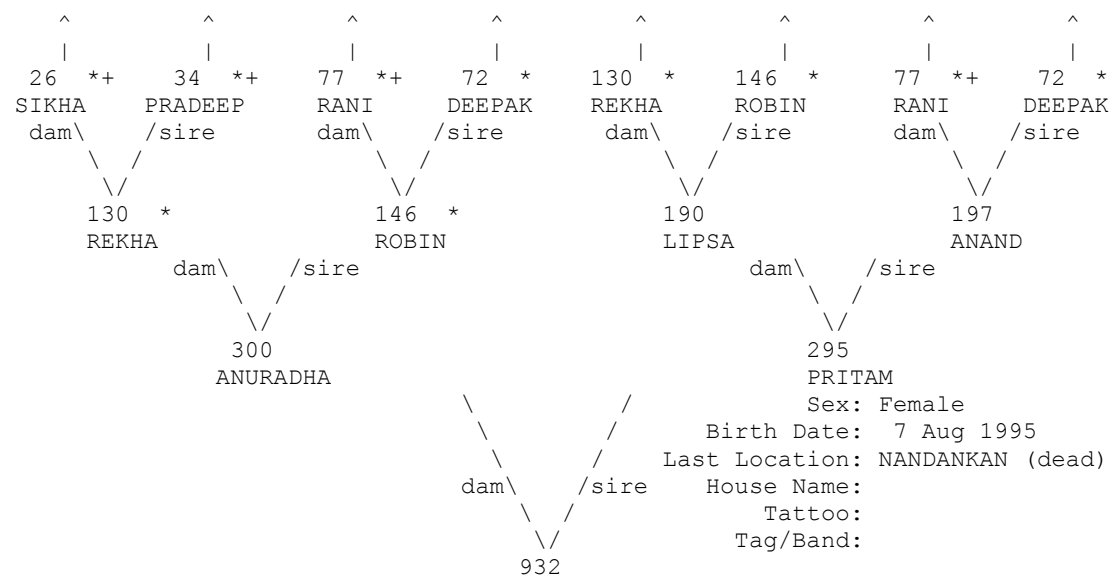

+ Wild-caught... * Appear more than once...
 ^ Pedigree continues beyond top of page...

=====
 Taxon Name: PANTHERA TIGRIS Studbook Number: 933
 =====

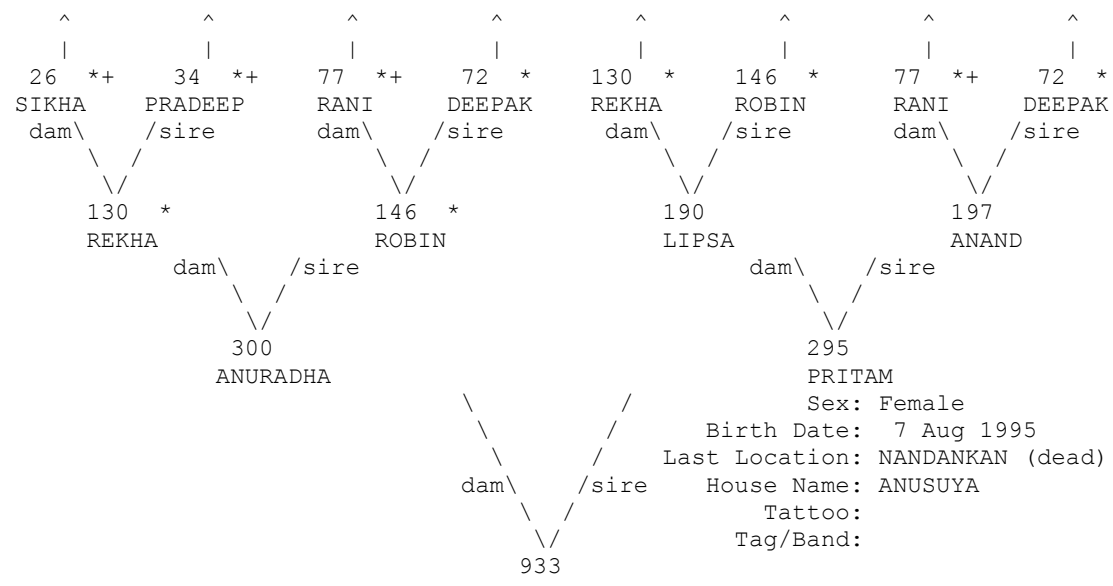

+ Wild-caught... * Appear more than once...
 ^ Pedigree continues beyond top of page...

=====
 Taxon Name: PANTHERA TIGRIS Studbook Number: 934
 =====

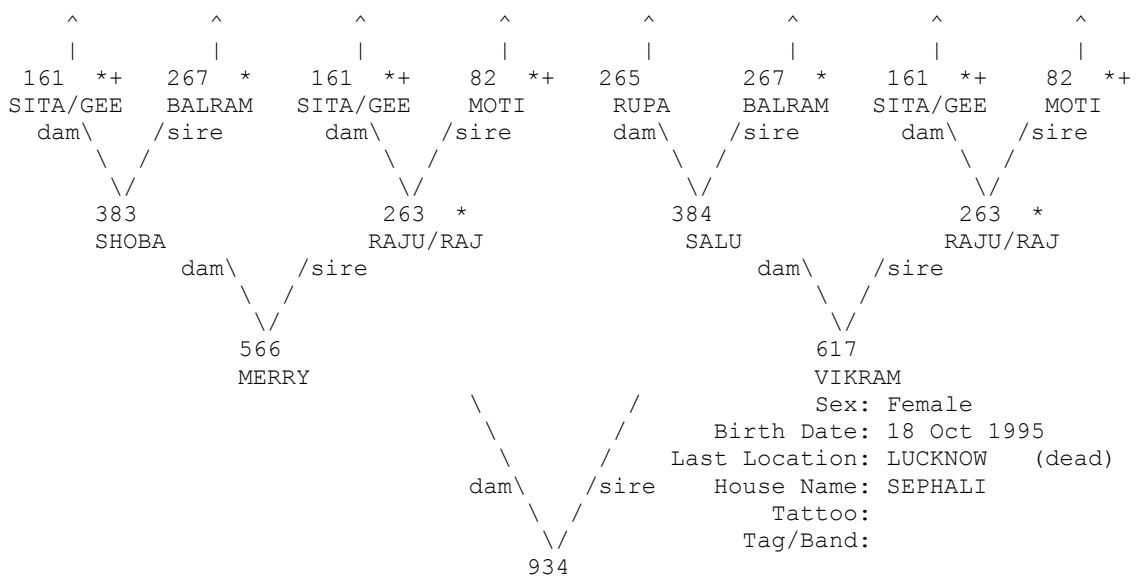

+ Wild-caught... * Appear more than once...
 ^ Pedigree continues beyond top of page...

=====
 Taxon Name: PANTHERA TIGRIS Studbook Number: 935
 =====

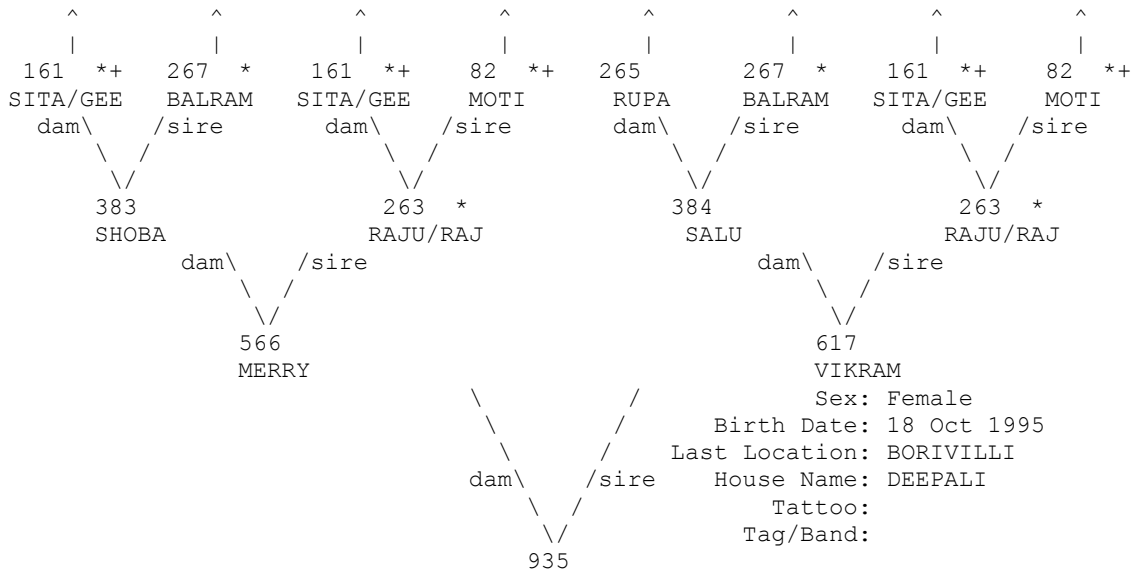

+ Wild-caught... * Appear more than once...
 ^ Pedigree continues beyond top of page...

=====
 Taxon Name: PANTHERA TIGRIS Studbook Number: 936
 =====

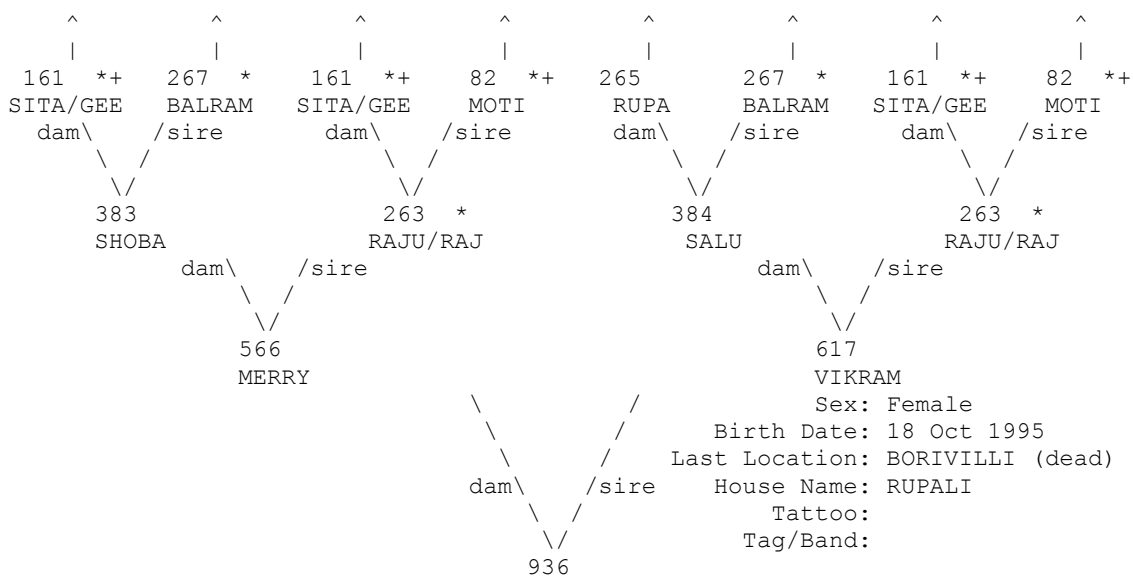

+ Wild-caught... * Appear more than once...
 ^ Pedigree continues beyond top of page...

=====
 Taxon Name: PANTHERA TIGRIS Studbook Number: 937
 =====

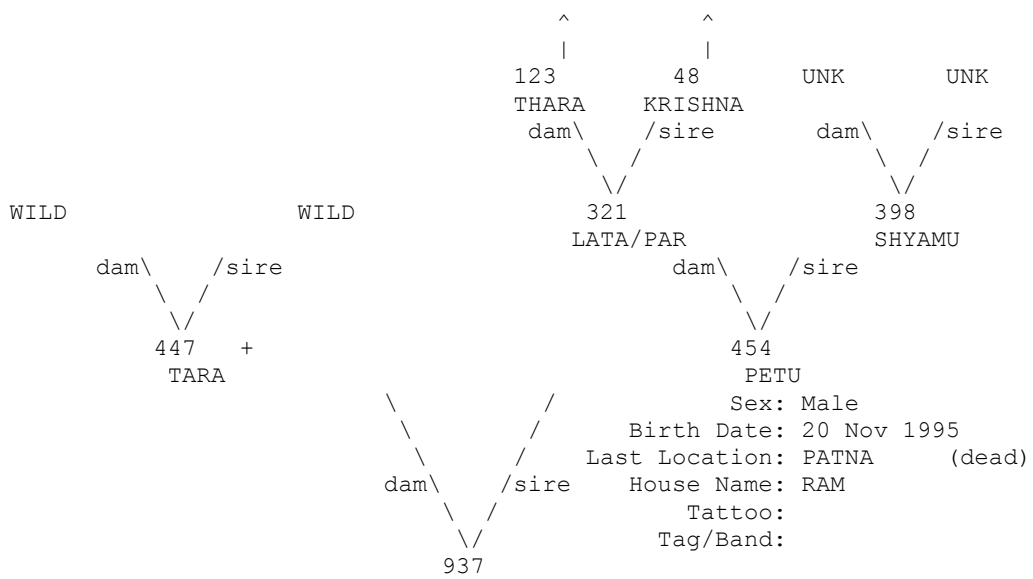

+ Wild-caught...
 ^ Pedigree continues beyond top of page...

=====
 Taxon Name: PANTHERA TIGRIS Studbook Number: 938
 =====

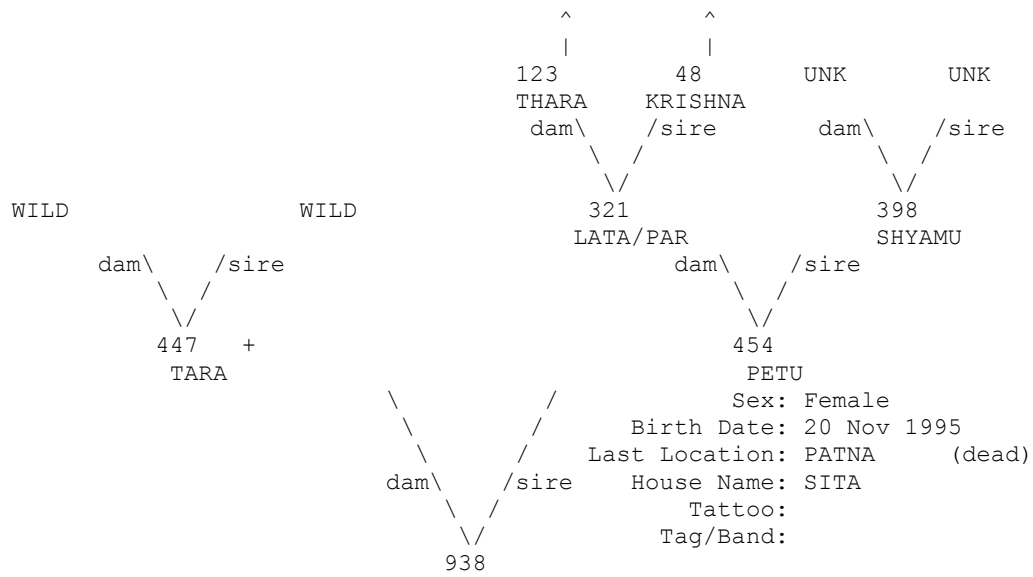

+ Wild-caught...
 ^ Pedigree continues beyond top of page...

=====
 Taxon Name: PANTHERA TIGRIS Studbook Number: 939
 =====

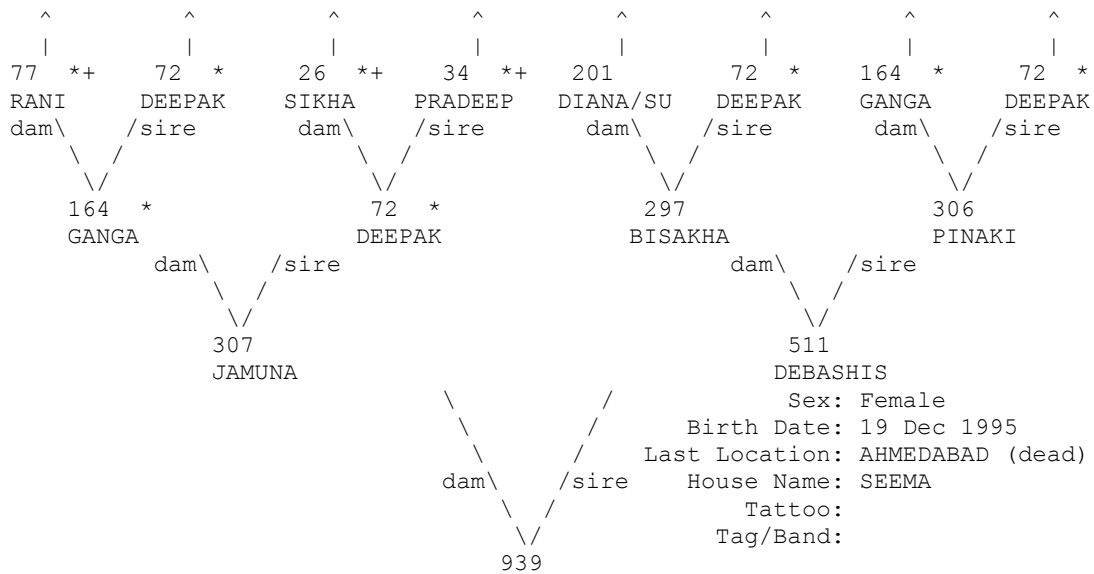

+ Wild-caught... * Appear more than once...
 ^ Pedigree continues beyond top of page...

=====
 Taxon Name: PANTHERA TIGRIS Studbook Number: 940
 =====

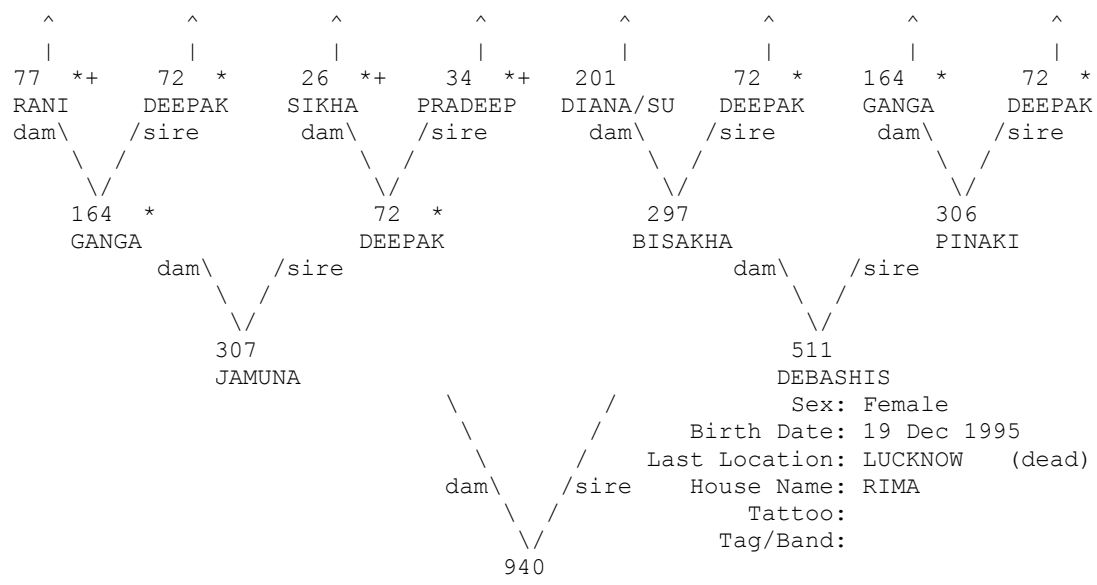

+ Wild-caught... * Appear more than once...
 ^ Pedigree continues beyond top of page...

=====
 Taxon Name: PANTHERA TIGRIS Studbook Number: 941
 =====

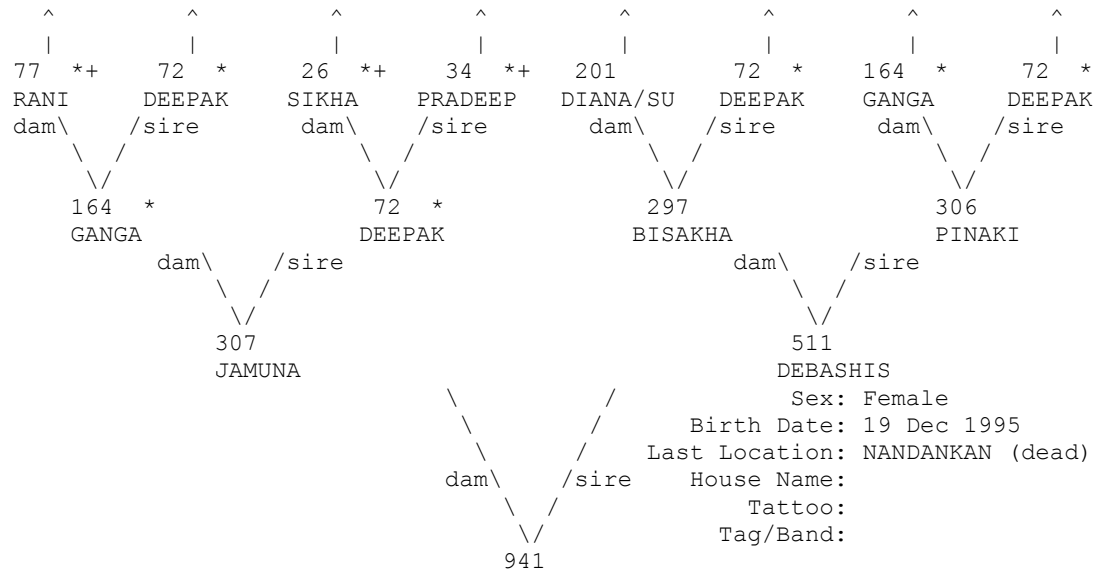

+ Wild-caught... * Appear more than once...
 ^ Pedigree continues beyond top of page...

=====
 Taxon Name: PANTHERA TIGRIS Studbook Number: 942
 =====

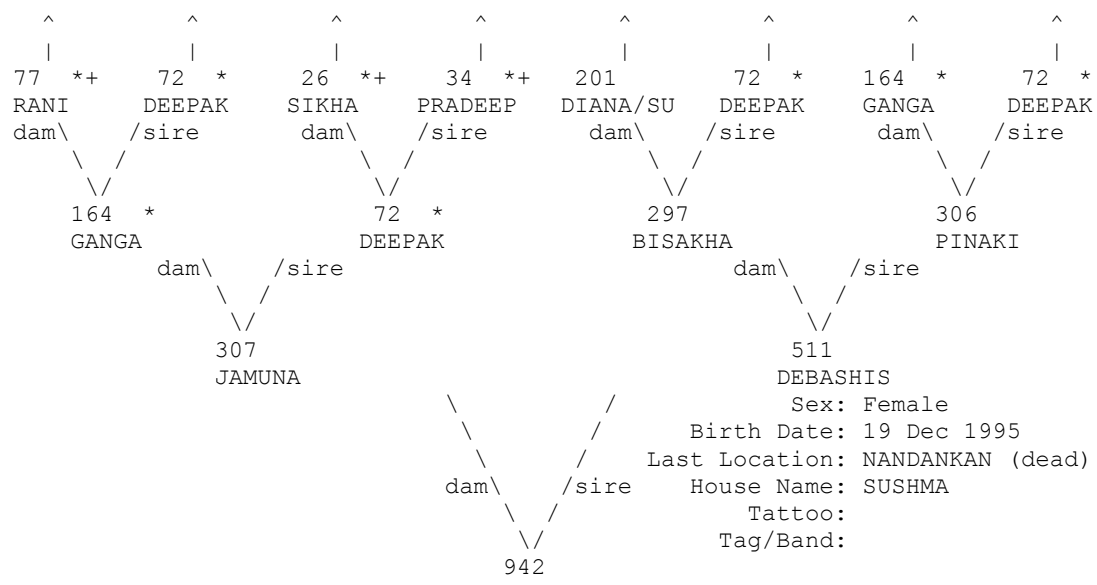

+ Wild-caught... * Appear more than once...
 ^ Pedigree continues beyond top of page...

=====
 Taxon Name: PANTHERA TIGRIS Studbook Number: 943
 =====

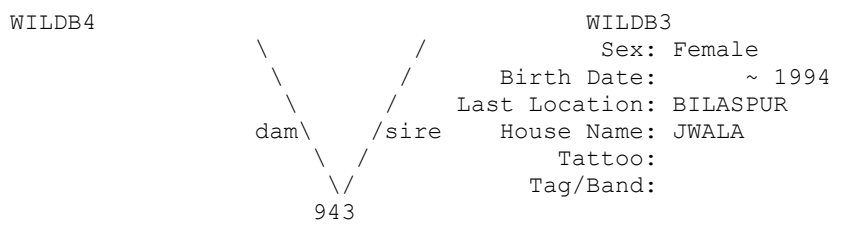

=====
 Taxon Name: PANTHERA TIGRIS Studbook Number: 944
 =====

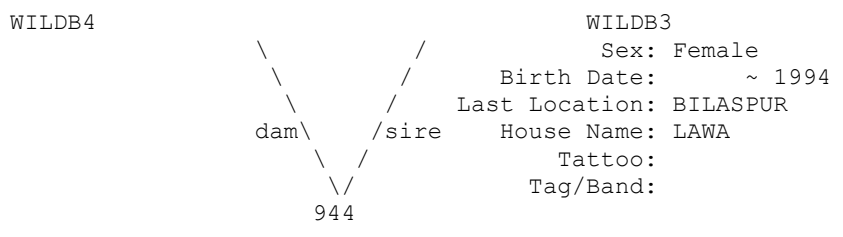

=====
 Taxon Name: PANTHERA TIGRIS Studbook Number: 945
 =====

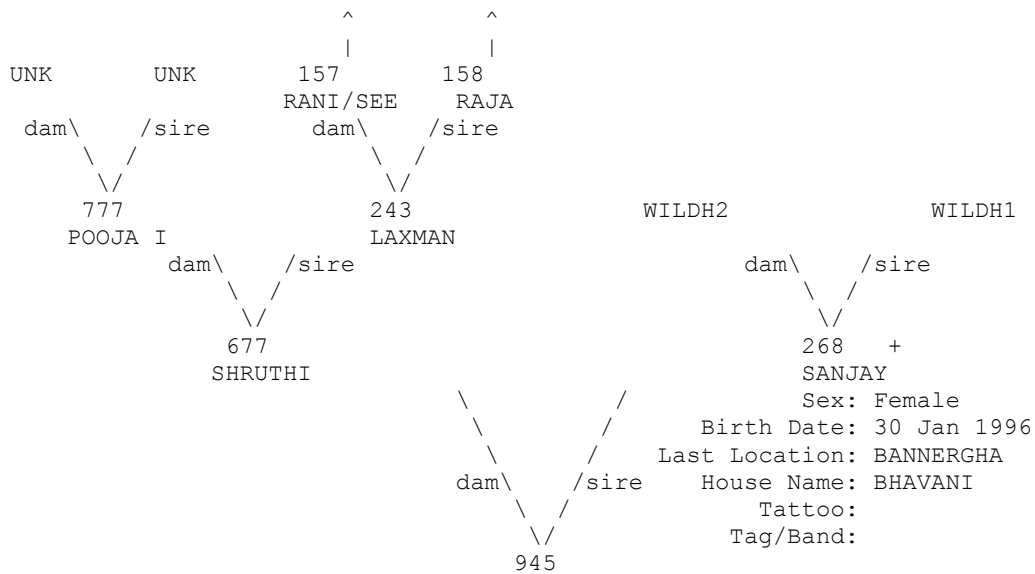

+ Wild-caught... * Appear more than once...
 ^ Pedigree continues beyond top of page...

=====
 Taxon Name: PANTHERA TIGRIS Studbook Number: 946
 =====

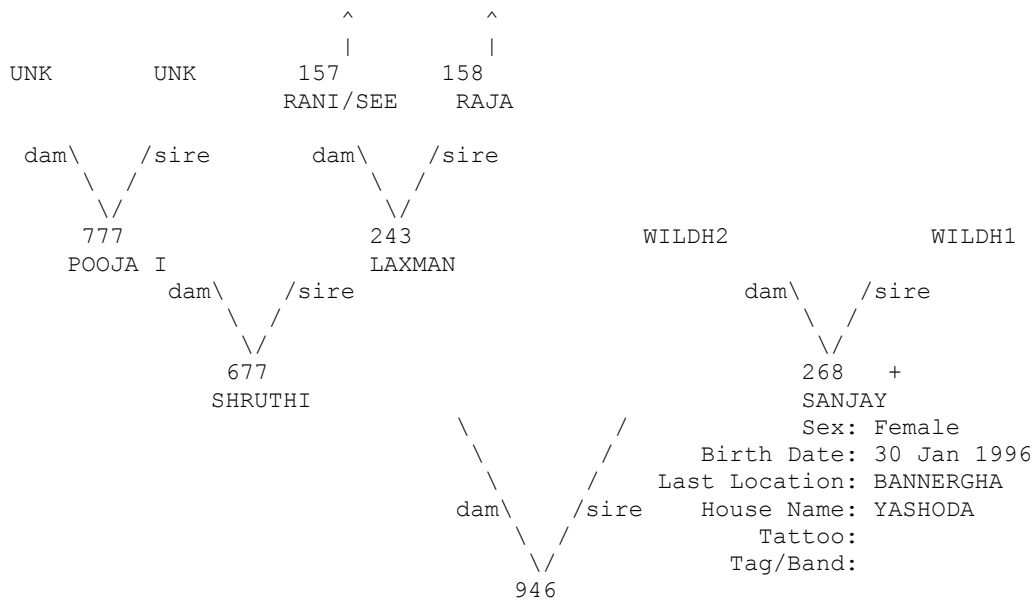

+ Wild-caught... * Appear more than once...
 ^ Pedigree continues beyond top of page...

=====

Taxon Name: PANTHERA TIGRIS Studbook Number: 949

=====

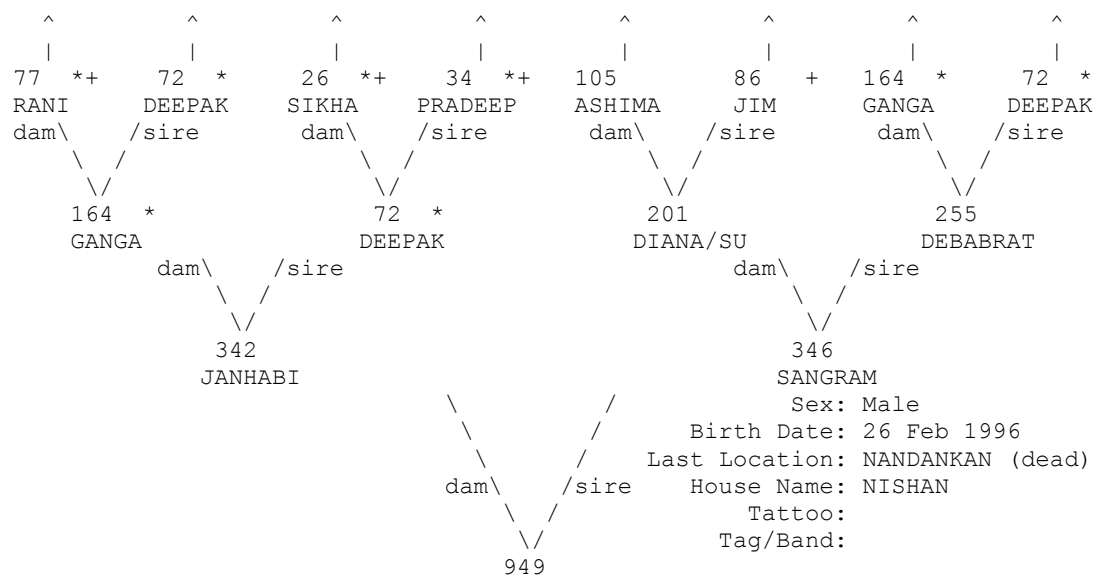

+ Wild-caught... * Appear more than once...

^ Pedigree continues beyond top of page...

=====

Taxon Name: PANTHERA TIGRIS Studbook Number: 950

=====

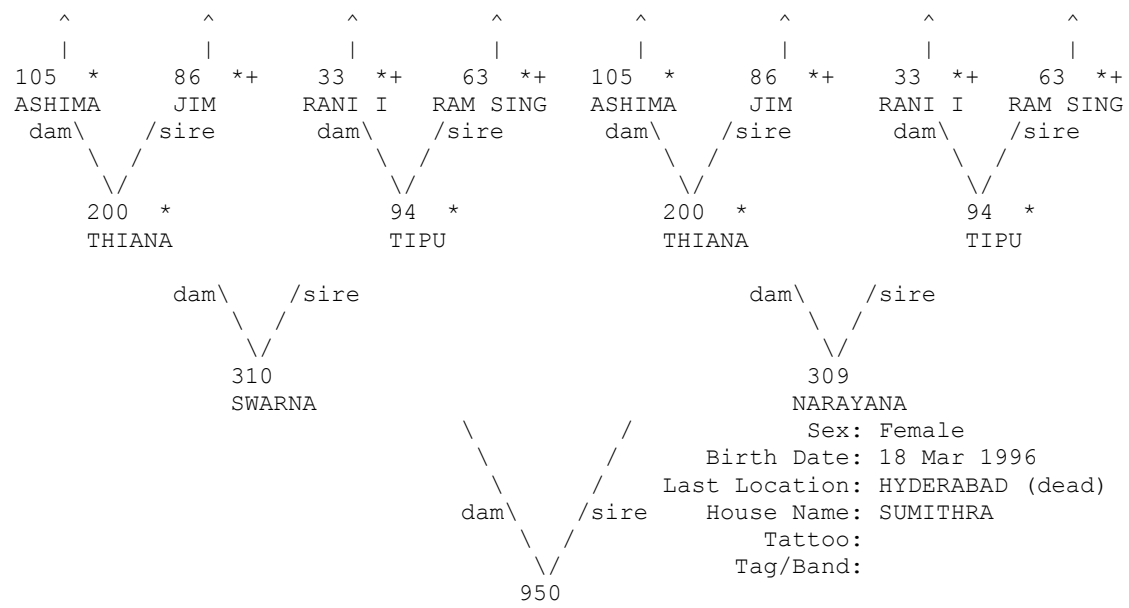

+ Wild-caught... * Appear more than once...

^ Pedigree continues beyond top of page...

=====
 Taxon Name: PANTHERA TIGRIS Studbook Number: 951
 =====

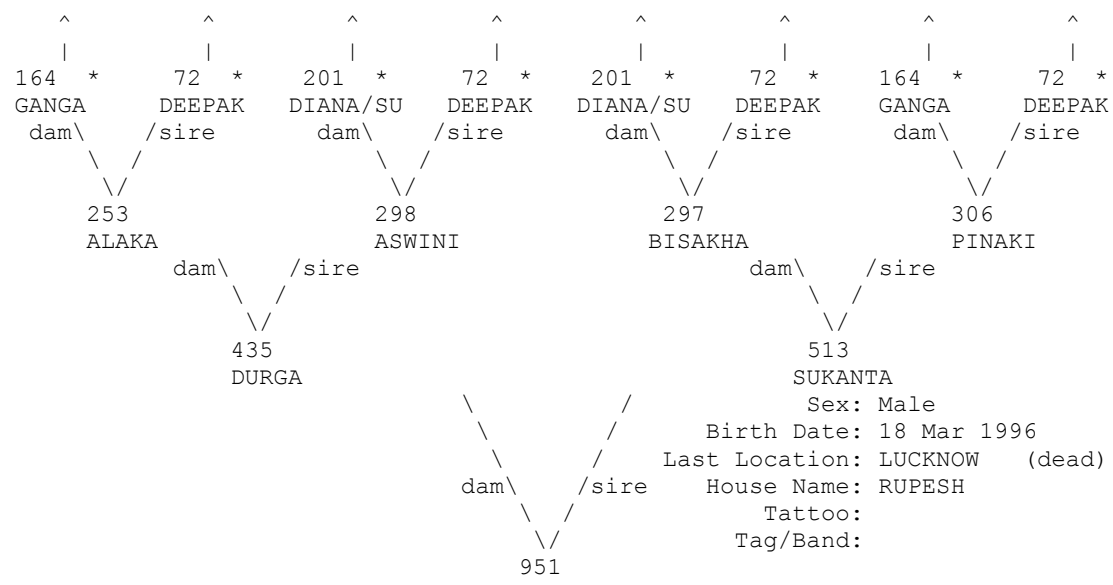

* Appear more than once...
 ^ Pedigree continues beyond top of page...

=====
 Taxon Name: PANTHERA TIGRIS Studbook Number: 952
 =====

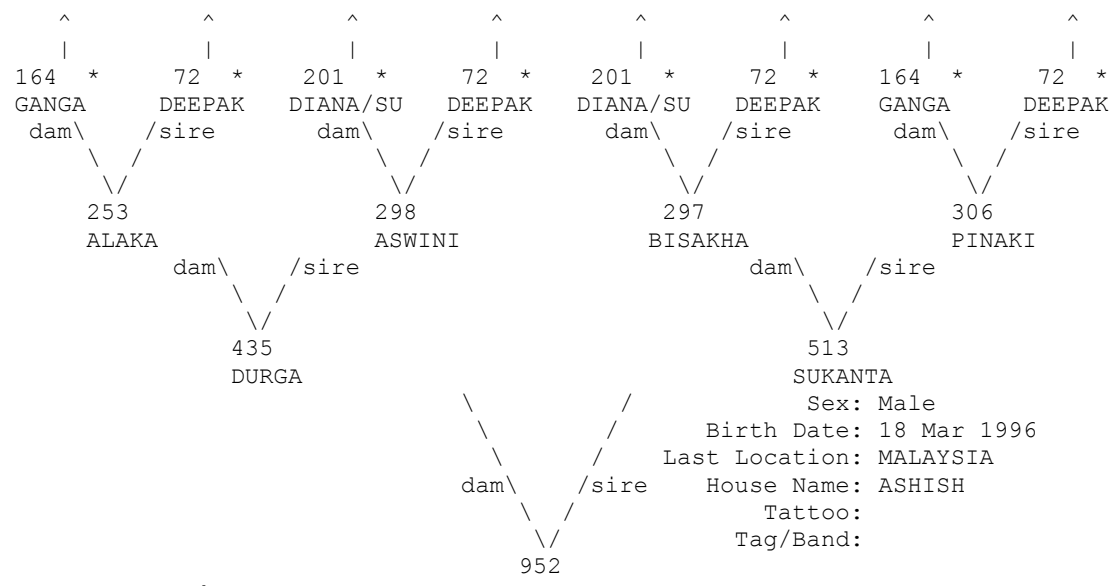

* Appear more than once...
 ^ Pedigree continues beyond top of page...

=====
 Taxon Name: PANTHERA TIGRIS Studbook Number: 953
 =====

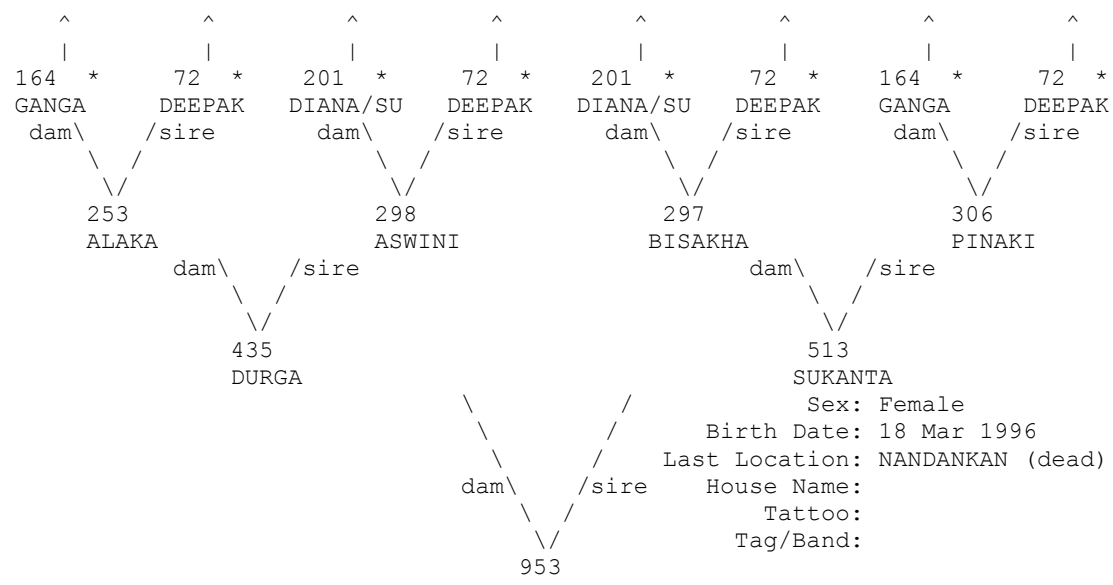

* Appear more than once...
 ^ Pedigree continues beyond top of page...

=====
 Taxon Name: PANTHERA TIGRIS Studbook Number: 954
 =====

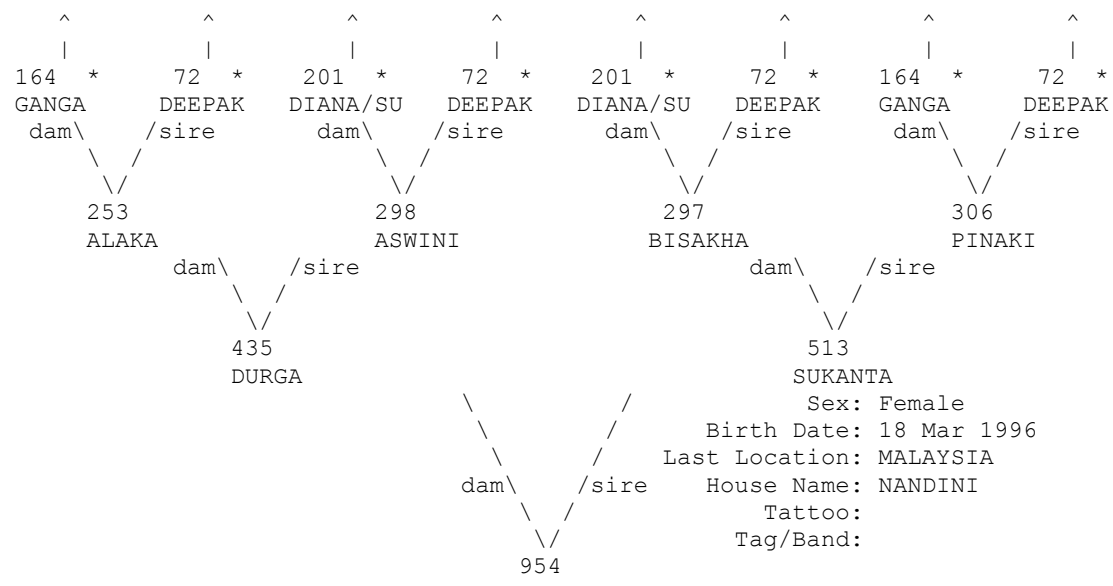

* Appear more than once...
 ^ Pedigree continues beyond top of page...

=====
 Taxon Name: PANTHERA TIGRIS Studbook Number: 955
 =====

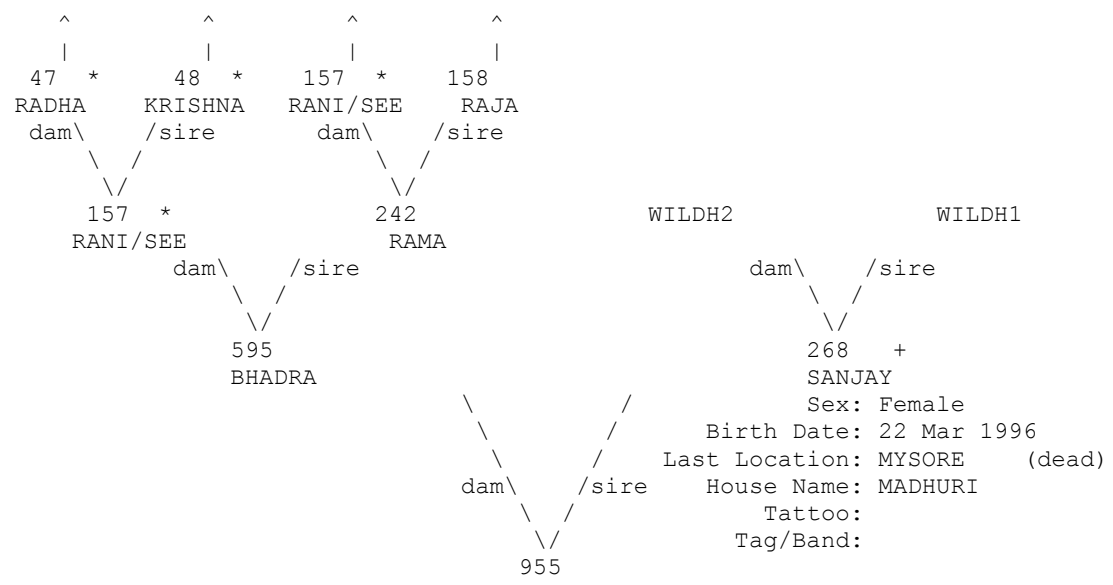

+ Wild-caught... * Appear more than once...
 ^ Pedigree continues beyond top of page...

=====
 Taxon Name: PANTHERA TIGRIS Studbook Number: 956
 =====

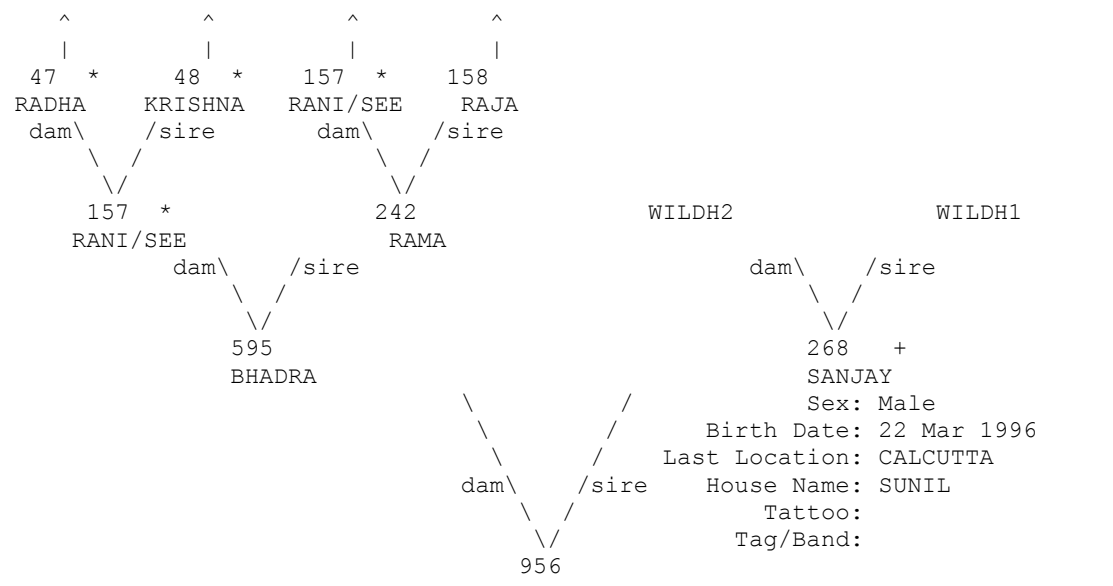

+ Wild-caught... * Appear more than once...
 ^ Pedigree continues beyond top of page...

=====
 Taxon Name: PANTHERA TIGRIS Studbook Number: 959
 =====

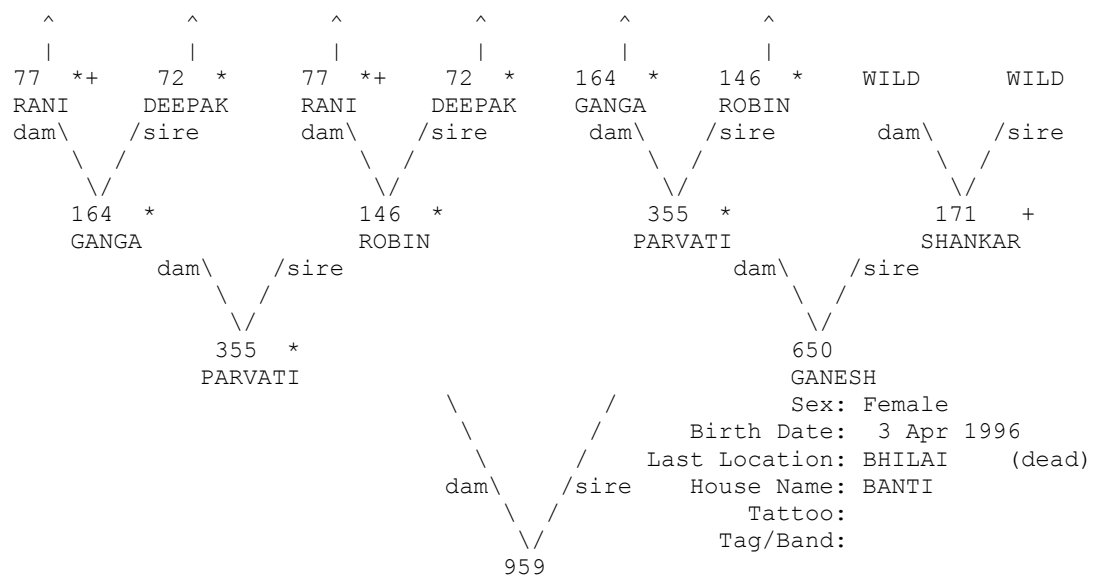

+ Wild-caught... * Appear more than once...
 ^ Pedigree continues beyond top of page...

=====
 Taxon Name: PANTHERA TIGRIS Studbook Number: 960
 =====

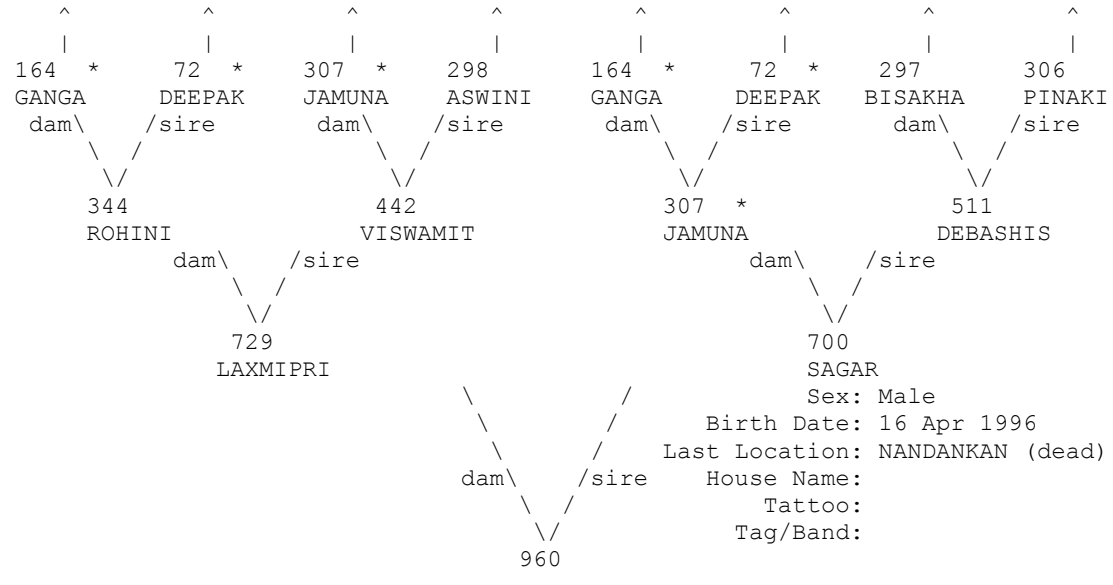

* Appear more than once...
 ^ Pedigree continues beyond top of page...

=====
 Taxon Name: PANTHERA TIGRIS Studbook Number: 961
 =====

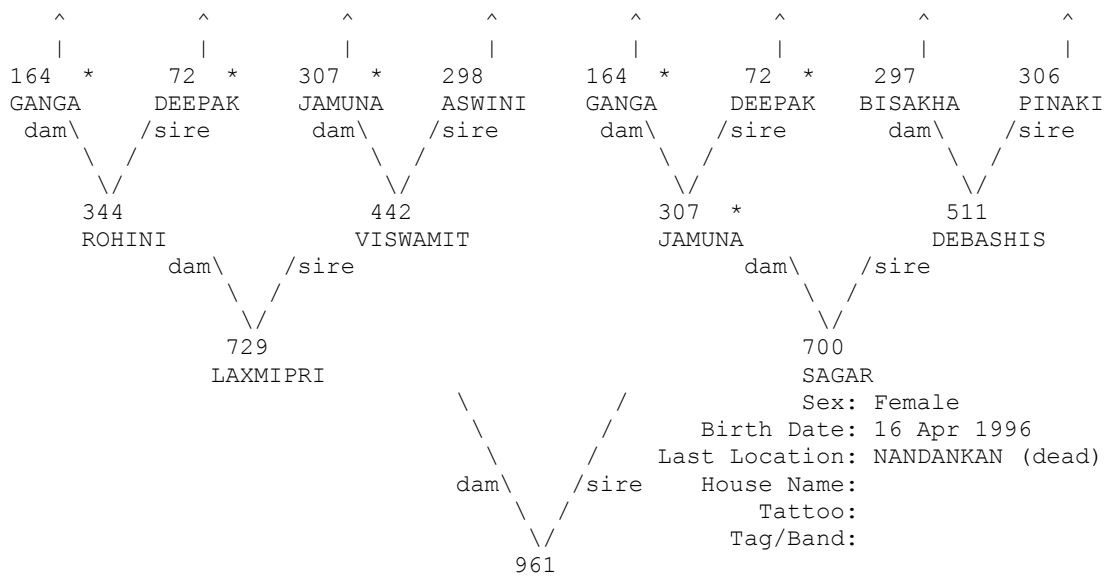

* Appear more than once...
 ^ Pedigree continues beyond top of page...

=====
 Taxon Name: PANTHERA TIGRIS Studbook Number: 962
 =====

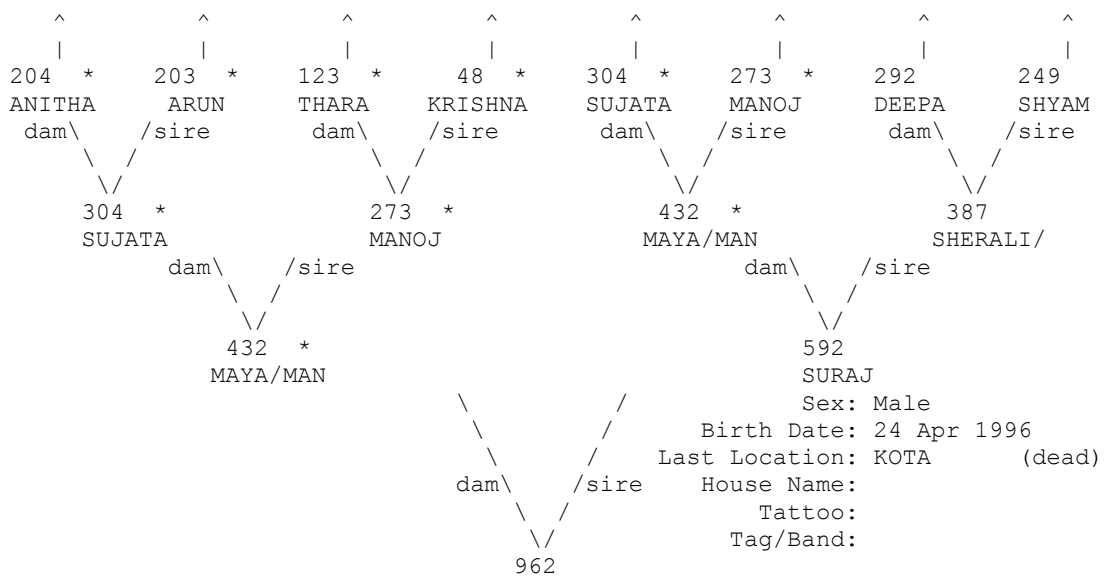

* Appear more than once...
 ^ Pedigree continues beyond top of page...

=====
 Taxon Name: PANTHERA TIGRIS Studbook Number: 963
 =====

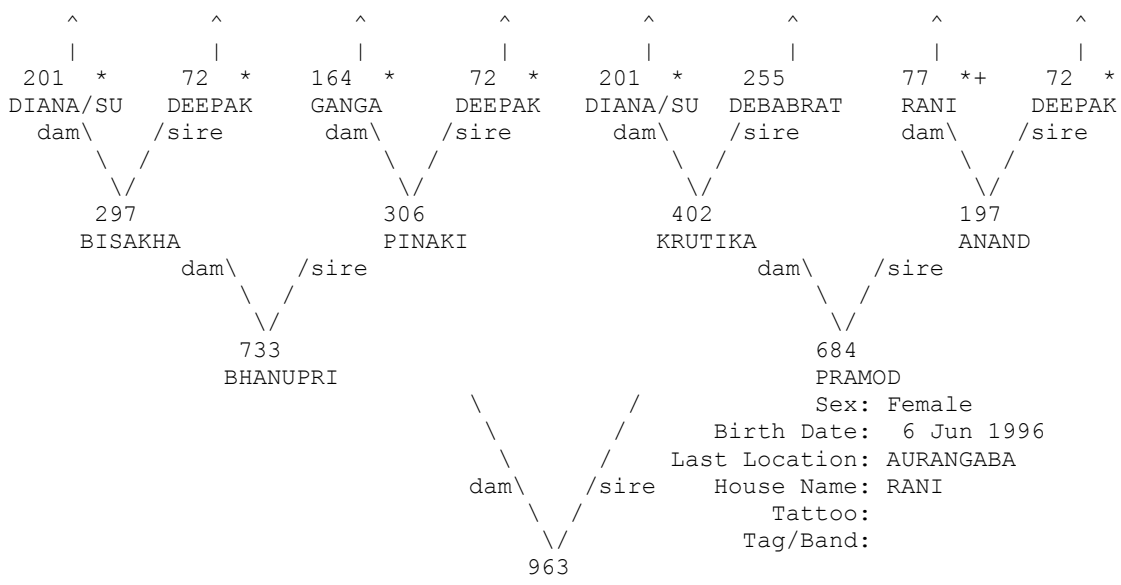

+ Wild-caught... * Appear more than once...
 ^ Pedigree continues beyond top of page...

=====
 Taxon Name: PANTHERA TIGRIS Studbook Number: 964
 =====

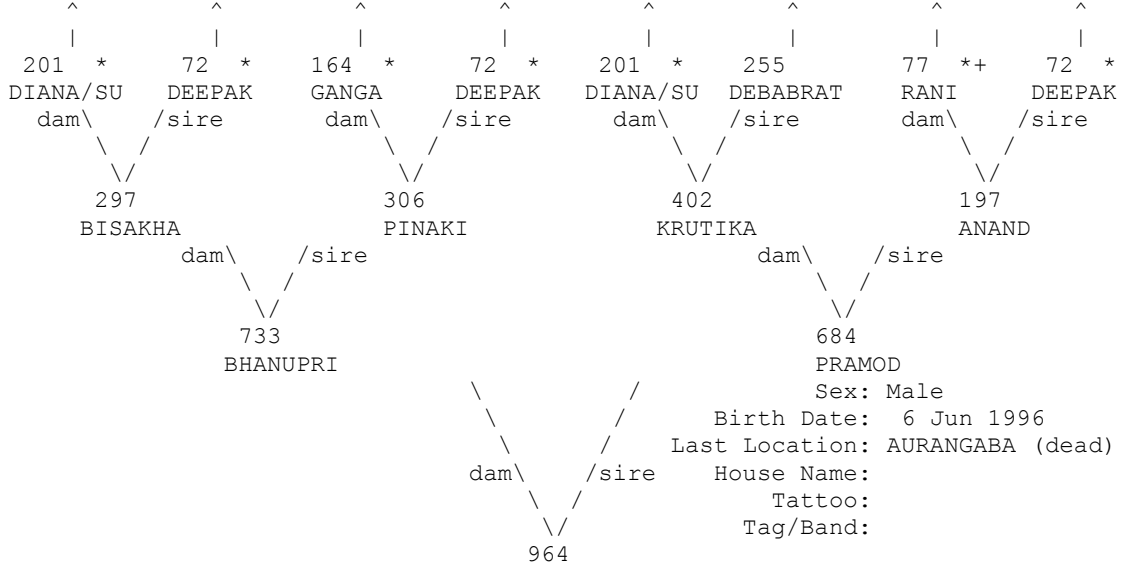

+ Wild-caught... * Appear more than once...
 ^ Pedigree continues beyond top of page...

=====
 Taxon Name: PANTHERA TIGRIS Studbook Number: 965
 =====

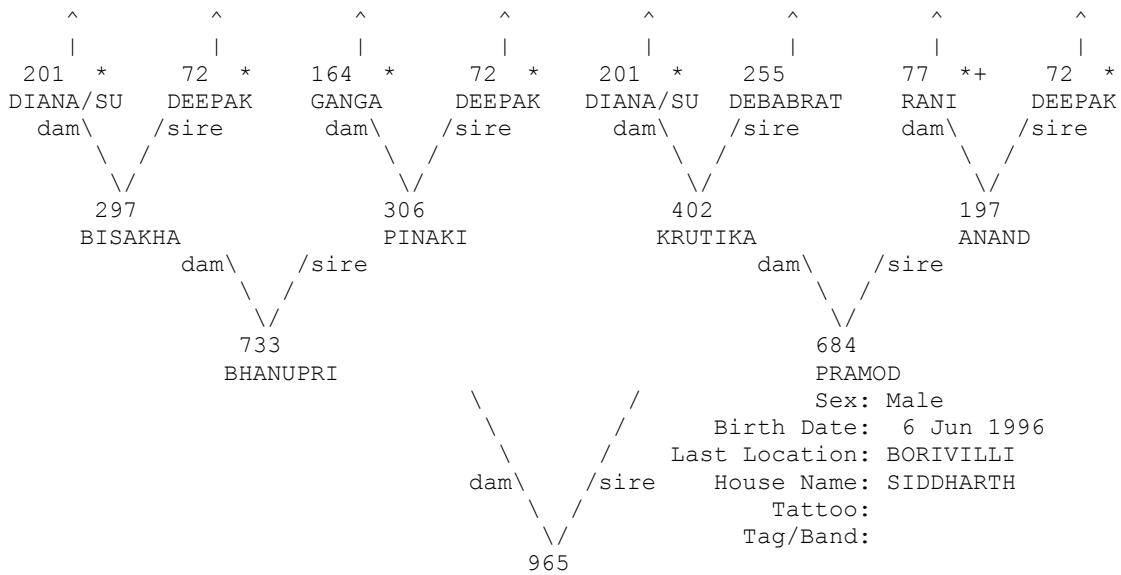

+ Wild-caught... * Appear more than once...
 ^ Pedigree continues beyond top of page...

=====
 Taxon Name: PANTHERA TIGRIS Studbook Number: 966
 =====

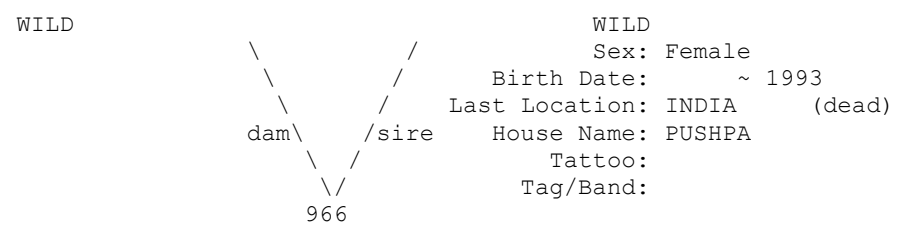

=====
 Taxon Name: PANTHERA TIGRIS Studbook Number: 967
 =====

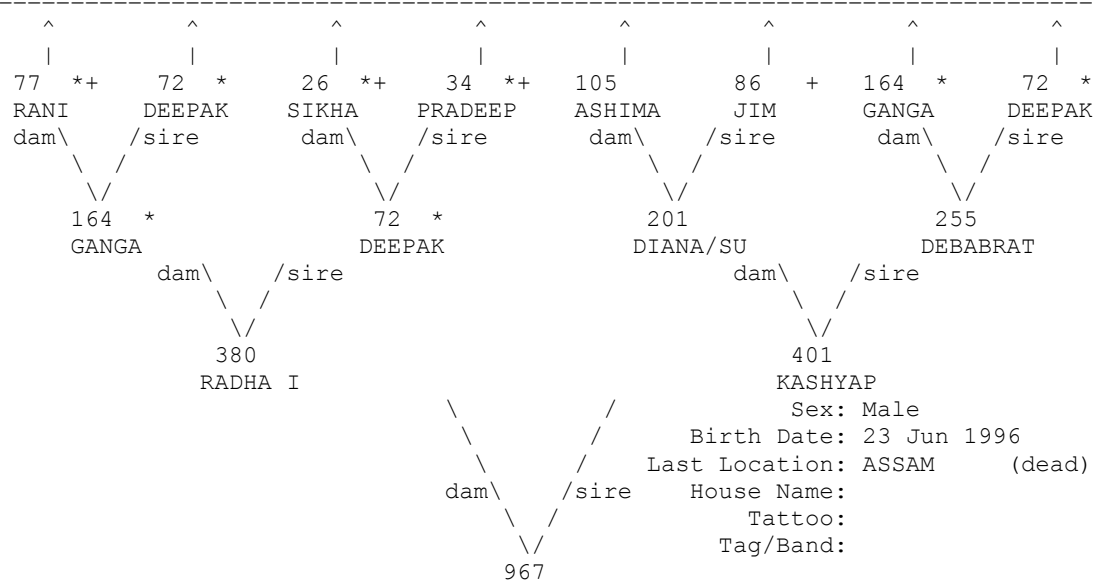

+ Wild-caught... * Appear more than once...
 ^ Pedigree continues beyond top of page...

=====
 Taxon Name: PANTHERA TIGRIS Studbook Number: 970
 =====

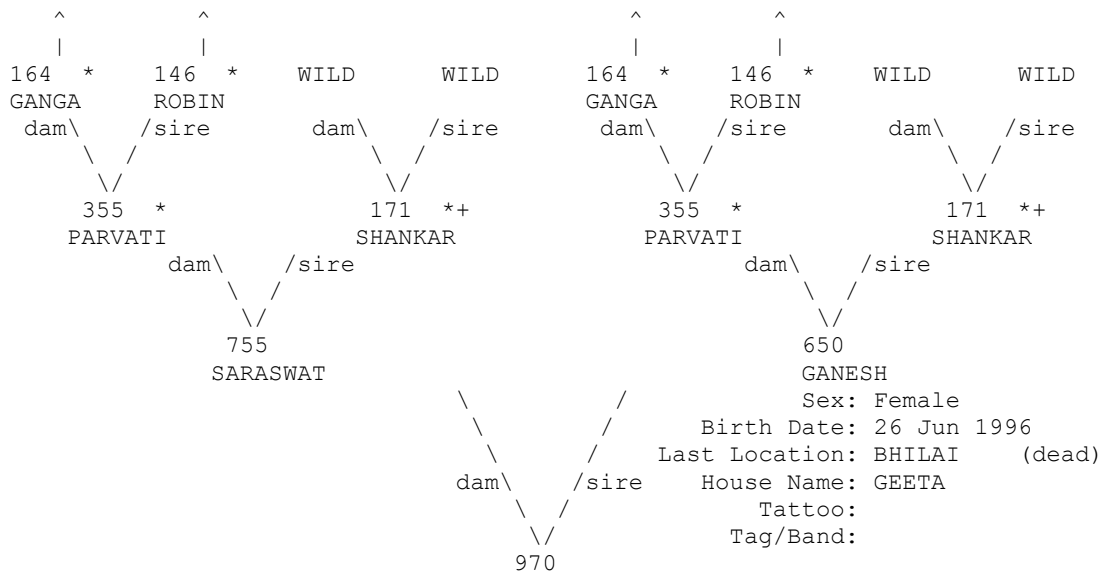

+ Wild-caught... * Appear more than once...
 ^ Pedigree continues beyond top of page...

=====
 Taxon Name: PANTHERA TIGRIS Studbook Number: 971
 =====

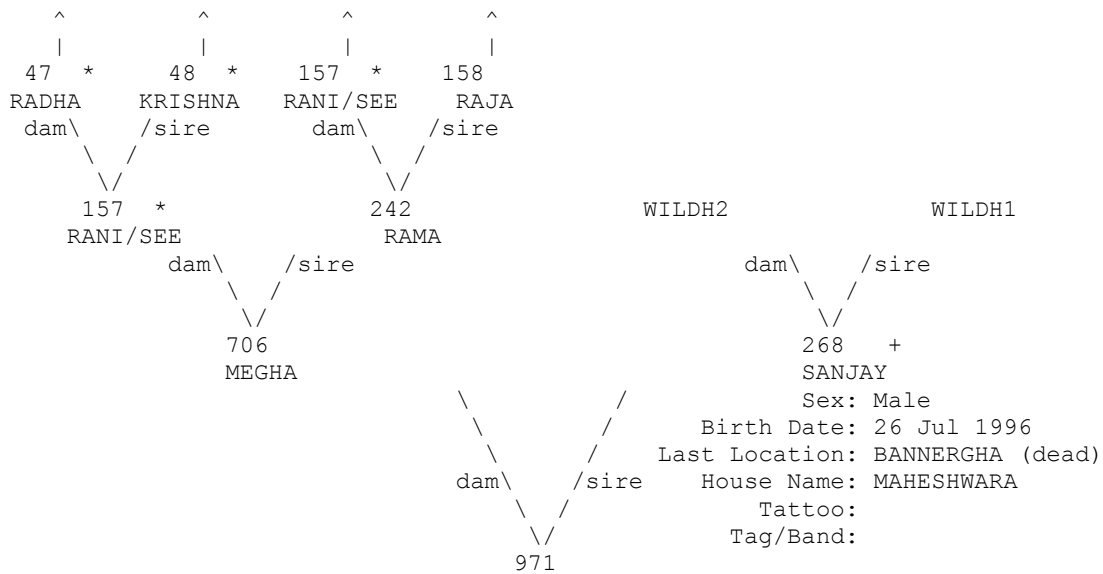

+ Wild-caught... * Appear more than once...
 ^ Pedigree continues beyond top of page...

=====
 Taxon Name: PANTHERA TIGRIS Studbook Number: 972
 =====

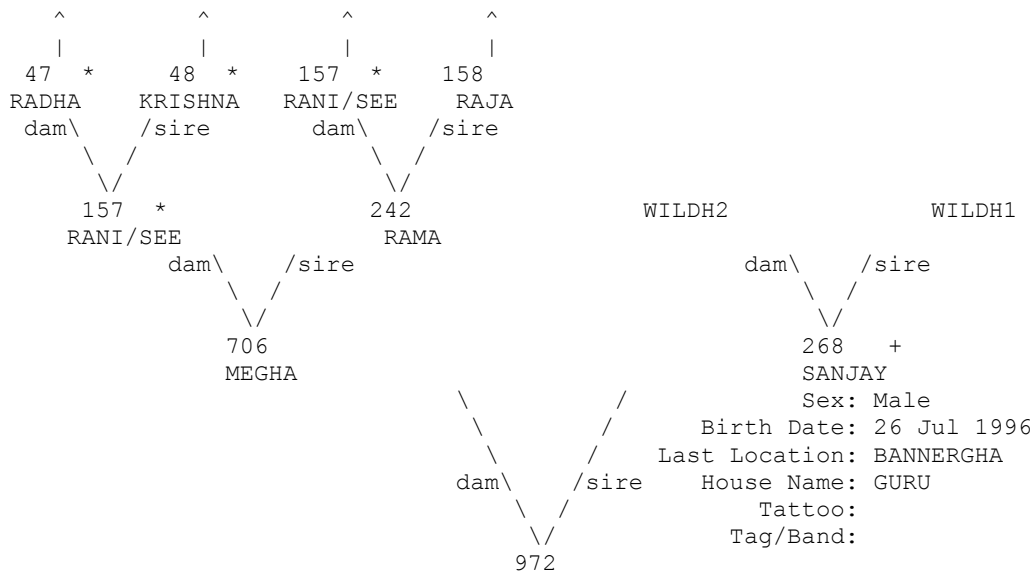

+ Wild-caught... * Appear more than once...
 ^ Pedigree continues beyond top of page...

=====
 Taxon Name: PANTHERA TIGRIS Studbook Number: 973
 =====

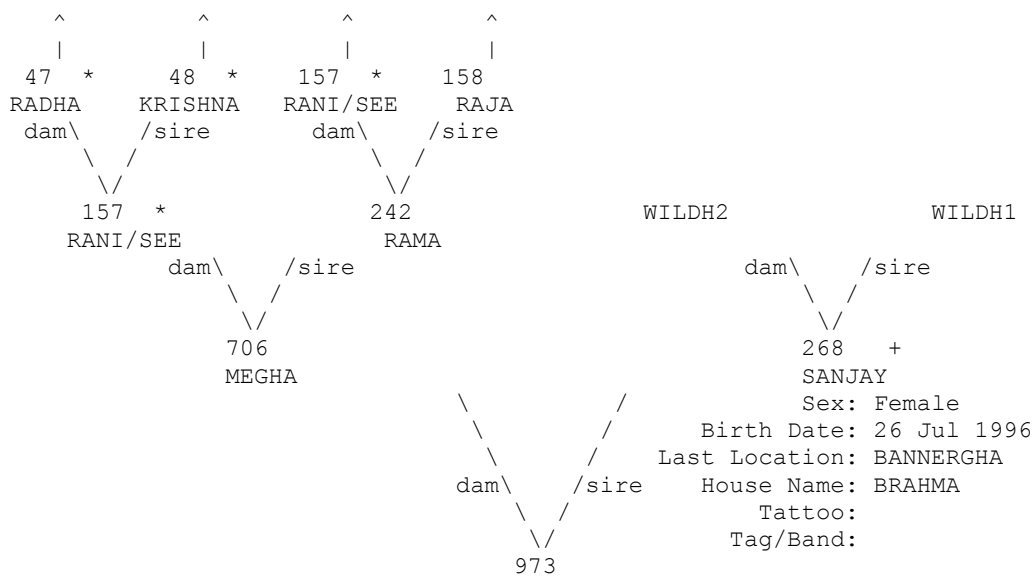

+ Wild-caught... * Appear more than once...
 ^ Pedigree continues beyond top of page...

=====
 Taxon Name: PANTHERA TIGRIS Studbook Number: 974
 =====

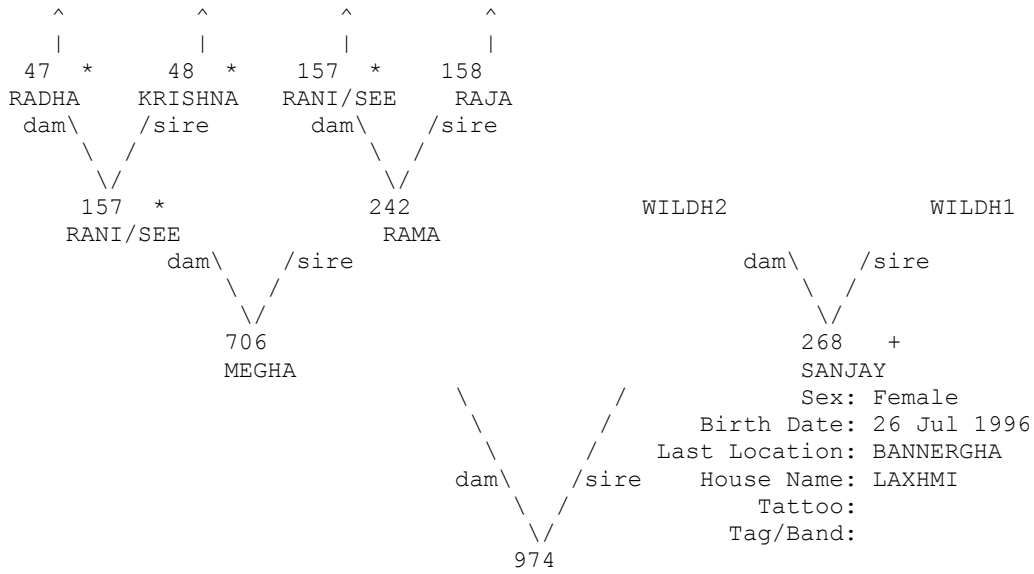

+ Wild-caught... * Appear more than once...
 ^ Pedigree continues beyond top of page...

=====
 Taxon Name: PANTHERA TIGRIS Studbook Number: 975
 =====

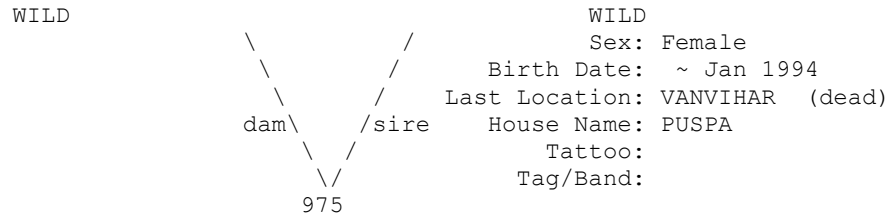

=====
 Taxon Name: PANTHERA TIGRIS Studbook Number: 976
 =====

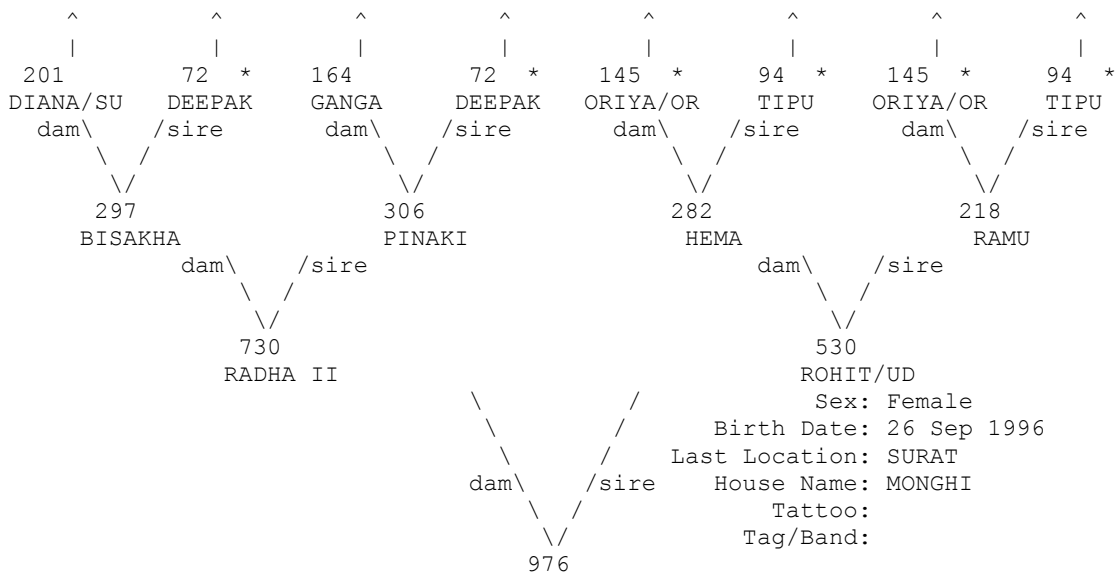

* Appear more than once...
 ^ Pedigree continues beyond top of page...

=====
 Taxon Name: PANTHERA TIGRIS Studbook Number: 977
 =====

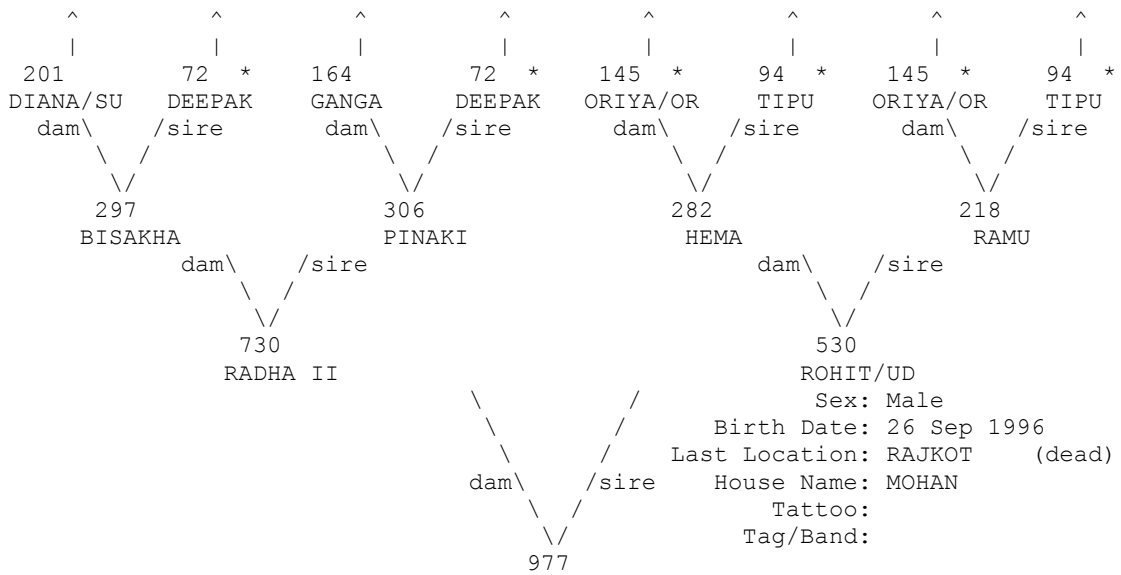

* Appear more than once...
 ^ Pedigree continues beyond top of page...

=====
 Taxon Name: PANTHERA TIGRIS Studbook Number: 978
 =====

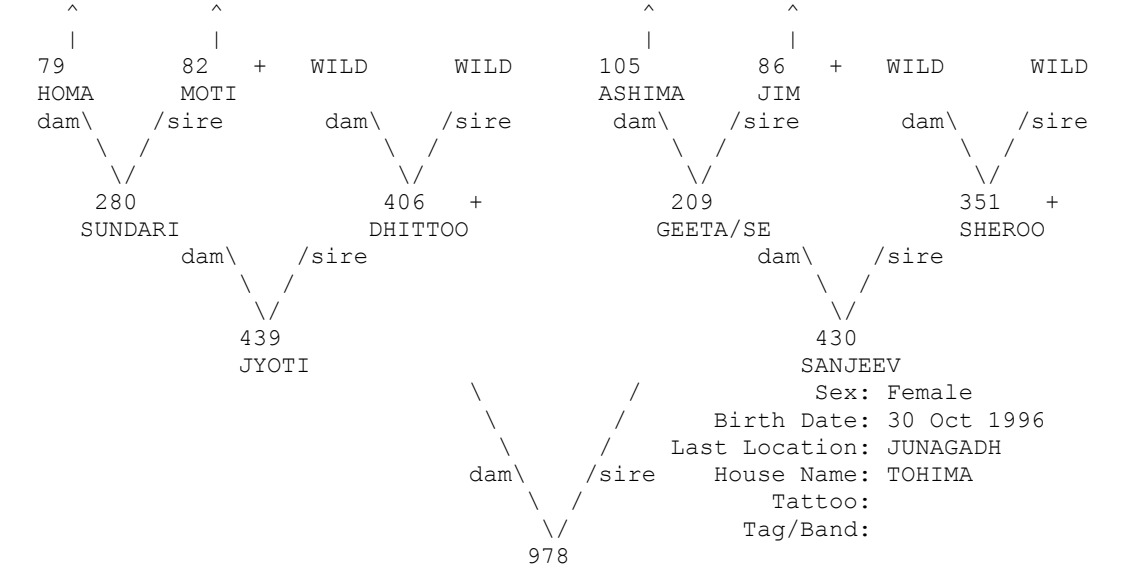

+ Wild-caught... * Appear more than once...
 ^ Pedigree continues beyond top of page...

=====
 Taxon Name: PANTHERA TIGRIS Studbook Number: 981
 =====

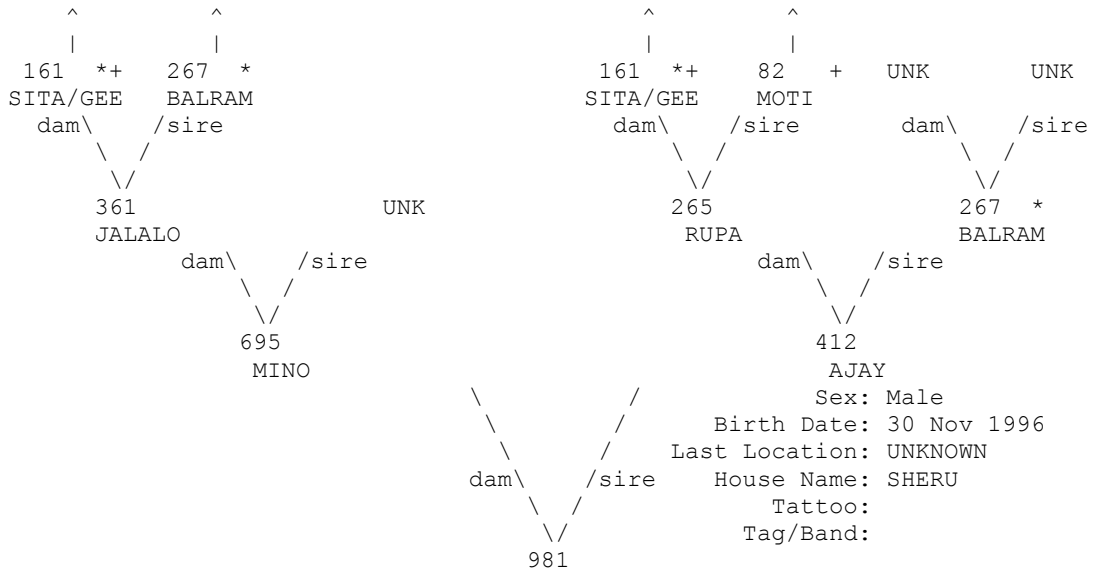

+ Wild-caught... * Appear more than once...
 ^ Pedigree continues beyond top of page...

=====
 Taxon Name: PANTHERA TIGRIS Studbook Number: 982
 =====

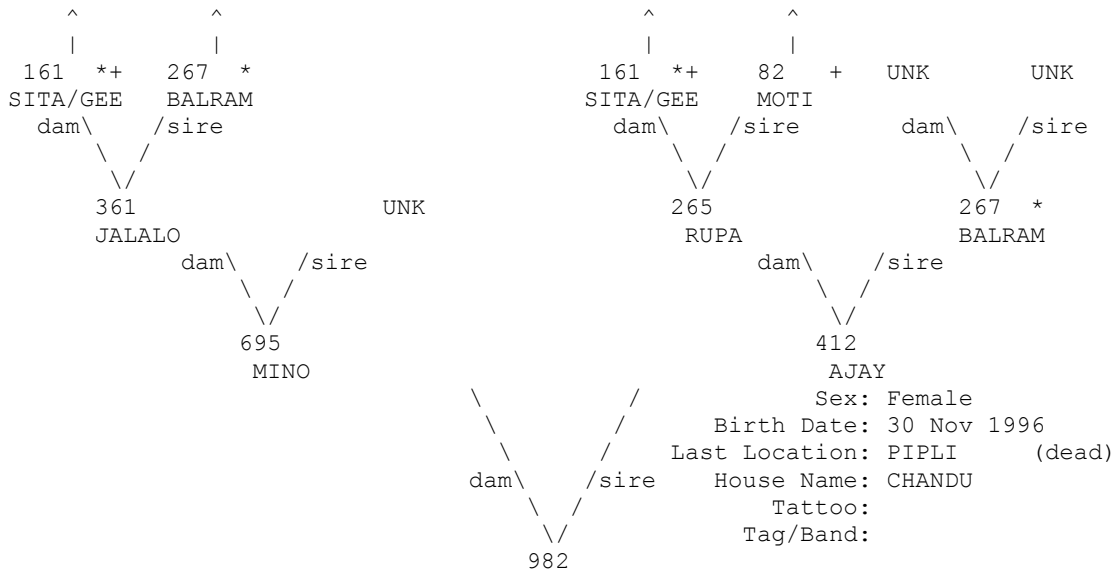

+ Wild-caught... * Appear more than once...
 ^ Pedigree continues beyond top of page...

=====
 Taxon Name: PANTHERA TIGRIS Studbook Number: 986
 =====

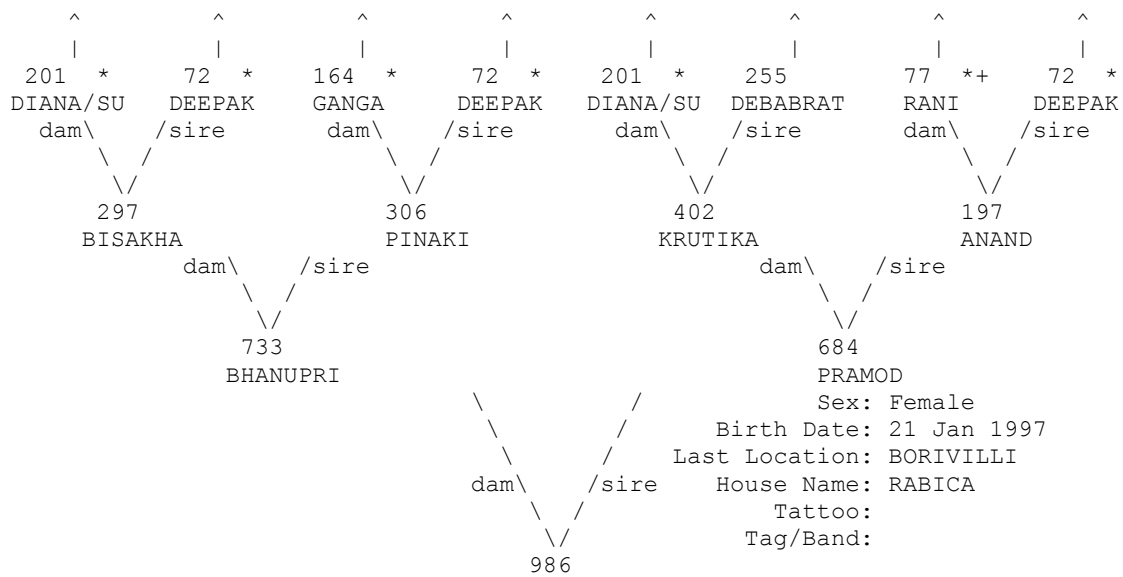

+ Wild-caught... * Appear more than once...
 ^ Pedigree continues beyond top of page...

=====
 Taxon Name: PANTHERA TIGRIS Studbook Number: 987
 =====

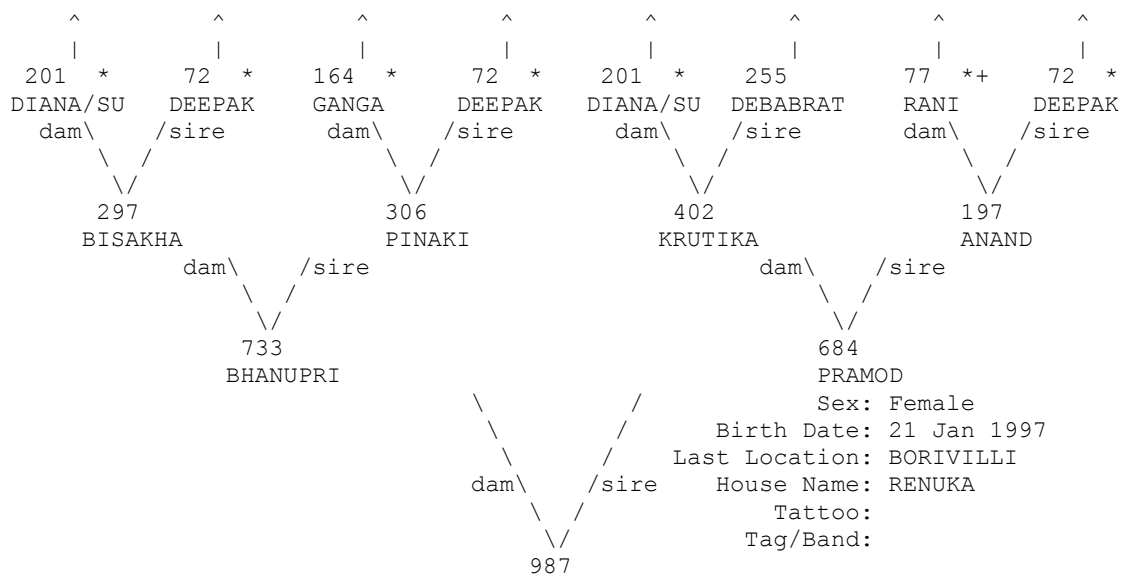

+ Wild-caught... * Appear more than once...
 ^ Pedigree continues beyond top of page...

=====
 Taxon Name: PANTHERA TIGRIS Studbook Number: 988
 =====

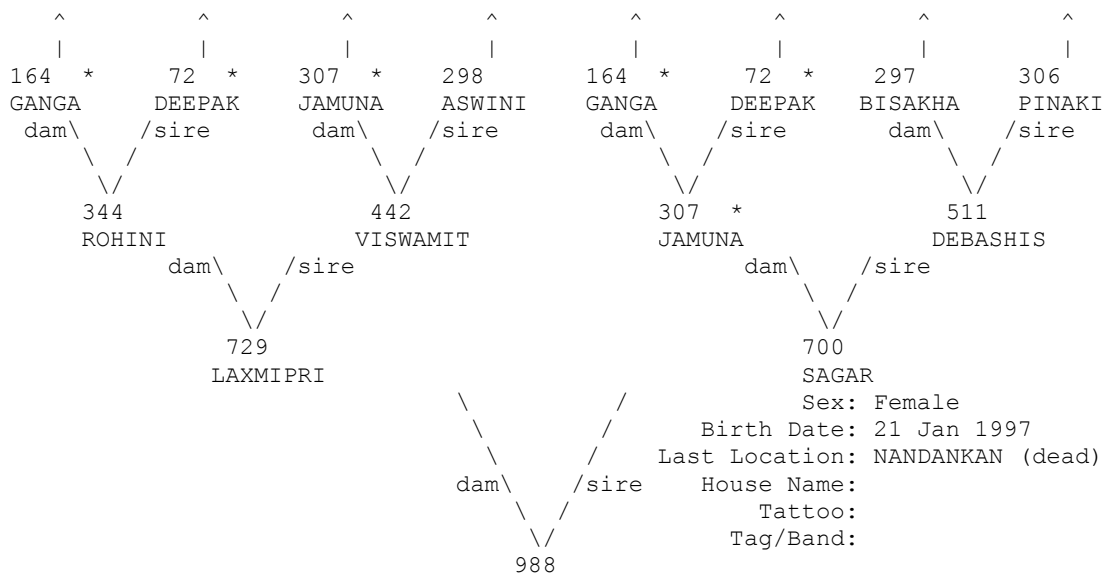

* Appear more than once...
 ^ Pedigree continues beyond top of page...

=====
 Taxon Name: PANTHERA TIGRIS Studbook Number: 989
 =====

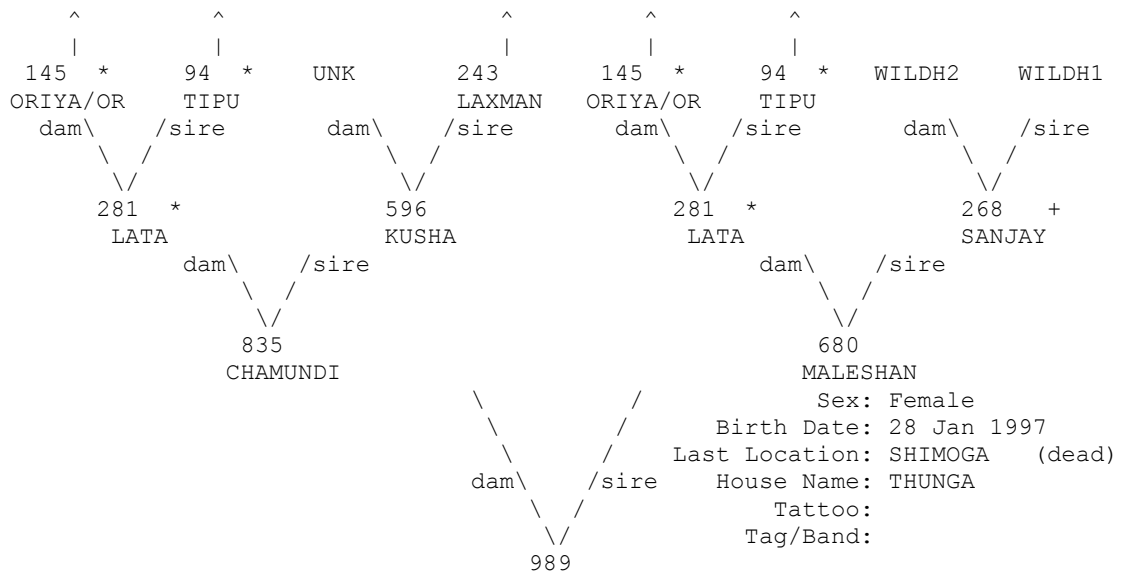

+ Wild-caught... * Appear more than once...
 ^ Pedigree continues beyond top of page...

=====
 Taxon Name: PANTHERA TIGRIS Studbook Number: 990
 =====

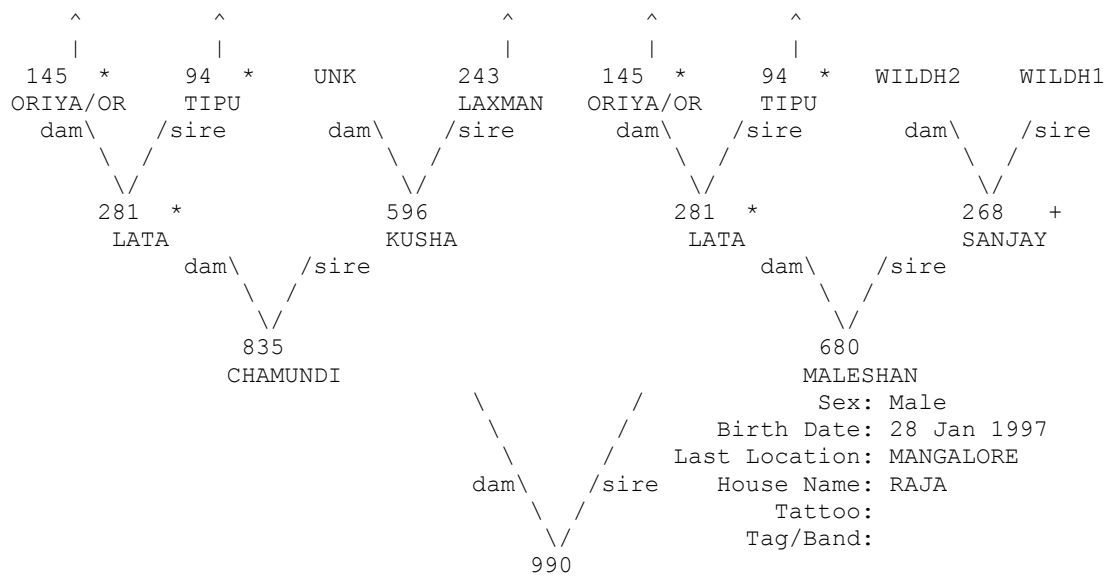

+ Wild-caught... * Appear more than once...
 ^ Pedigree continues beyond top of page...

=====
 Taxon Name: PANTHERA TIGRIS Studbook Number: 991
 =====

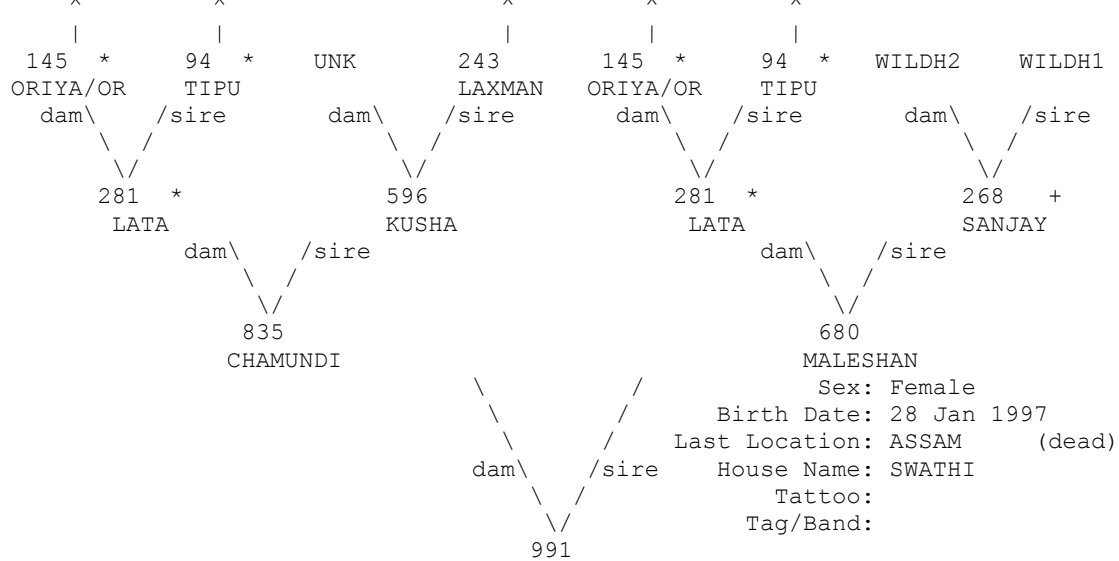

+ Wild-caught... * Appear more than once...
 ^ Pedigree continues beyond top of page...

=====
 Taxon Name: PANTHERA TIGRIS Studbook Number: 992
 =====

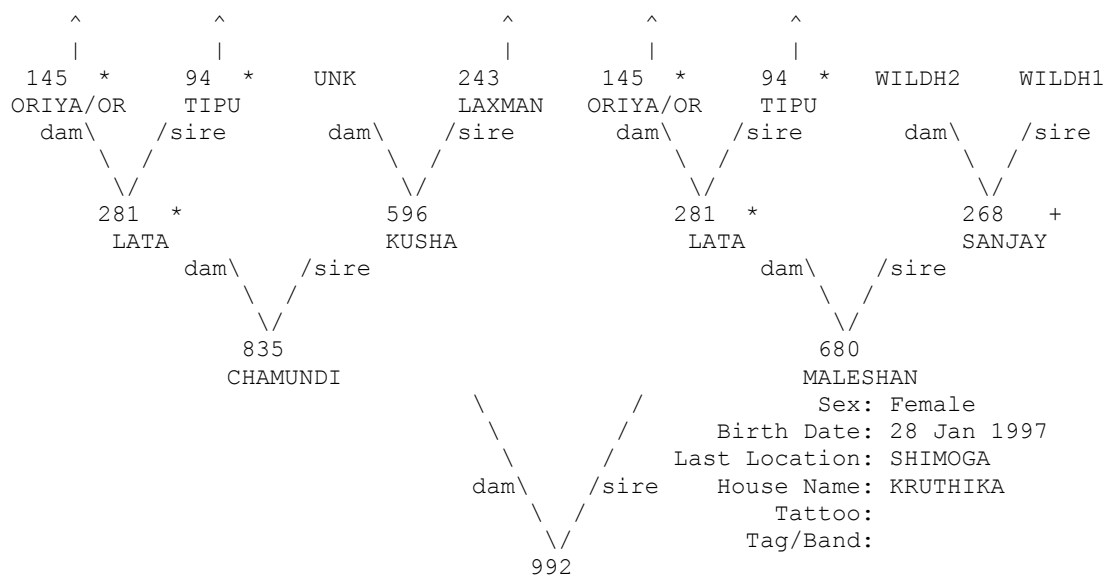

+ Wild-caught... * Appear more than once...
 ^ Pedigree continues beyond top of page...

=====
 Taxon Name: PANTHERA TIGRIS Studbook Number: 993
 =====

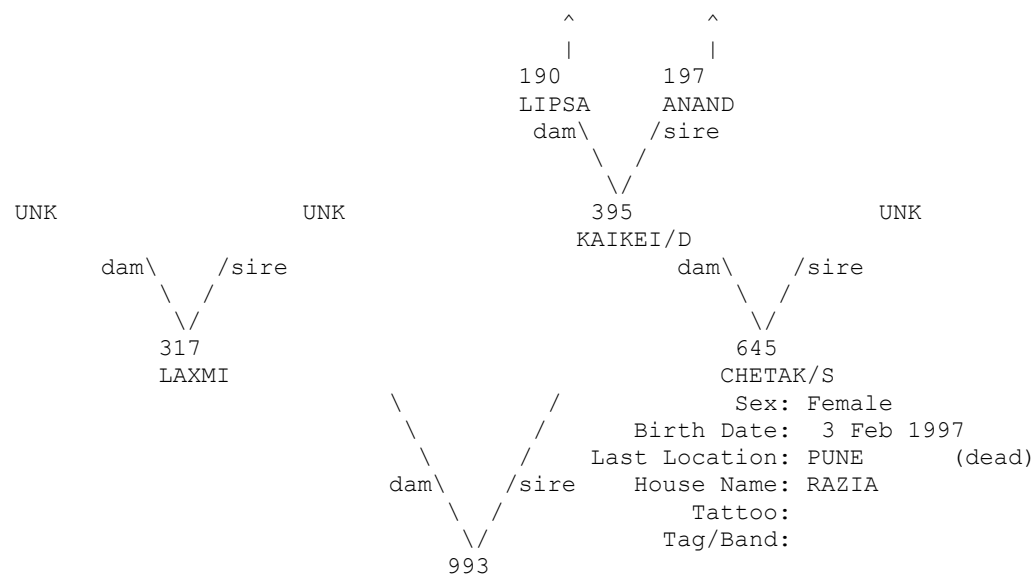

* Appear more than once...
 ^ Pedigree continues beyond top of page...

=====
 Taxon Name: PANTHERA TIGRIS Studbook Number: 994
 =====

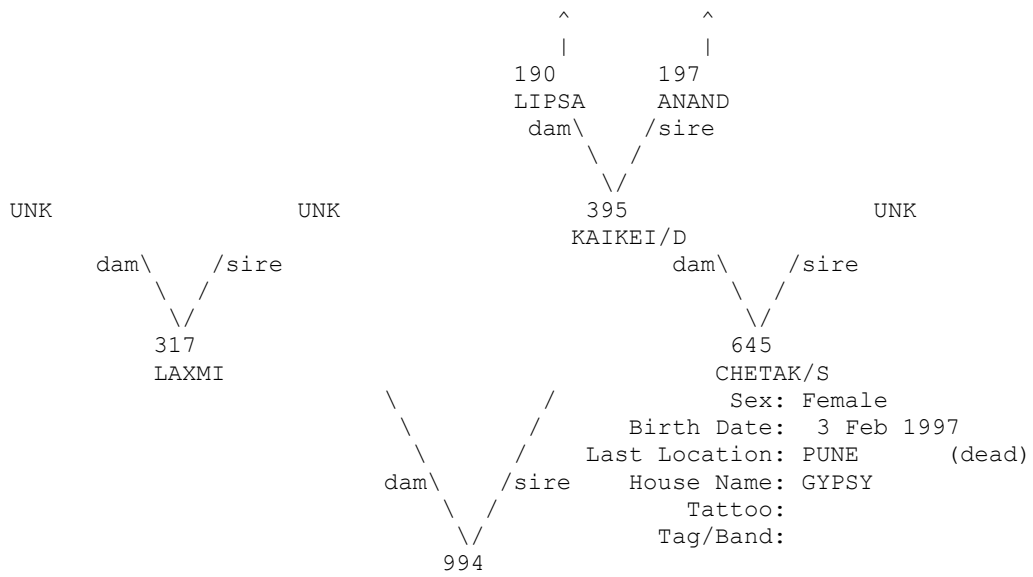

* Appear more than once...
 ^ Pedigree continues beyond top of page...

=====
 Taxon Name: PANTHERA TIGRIS Studbook Number: 995
 =====

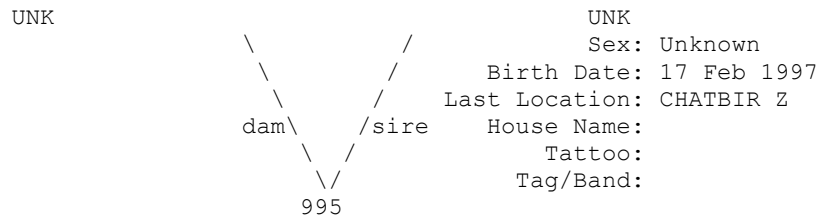

=====
 Taxon Name: PANTHERA TIGRIS Studbook Number: 996
 =====

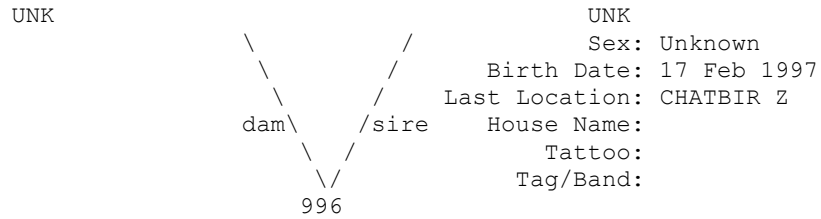

=====
 Taxon Name: PANTHERA TIGRIS Studbook Number: 997
 =====

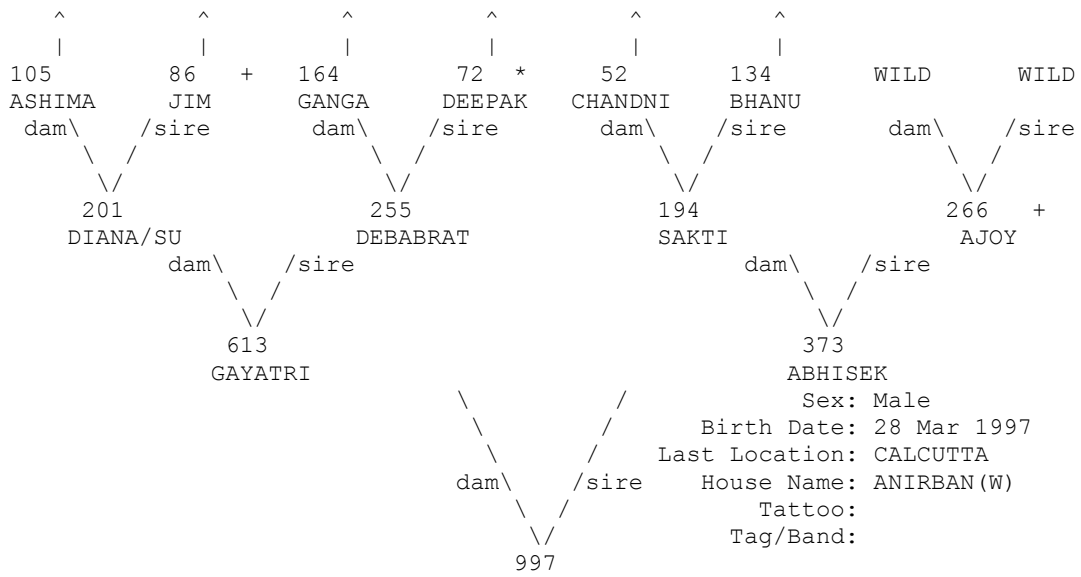

+ Wild-caught... * Appear more than once...
 ^ Pedigree continues beyond top of page...

=====
 Taxon Name: PANTHERA TIGRIS Studbook Number: 998
 =====

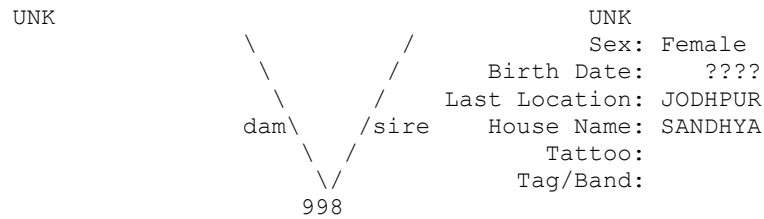

=====
 Taxon Name: PANTHERA TIGRIS Studbook Number: 999
 =====

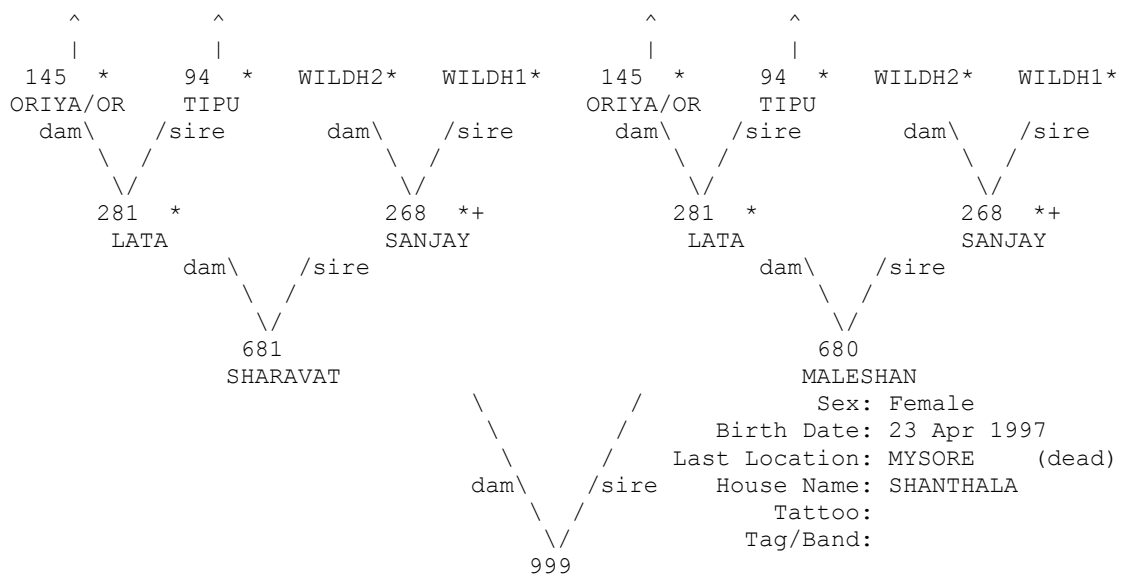

+ Wild-caught... * Appear more than once...
 ^ Pedigree continues beyond top of page...

=====
 Taxon Name: PANTHERA TIGRIS Studbook Number: 1000
 =====

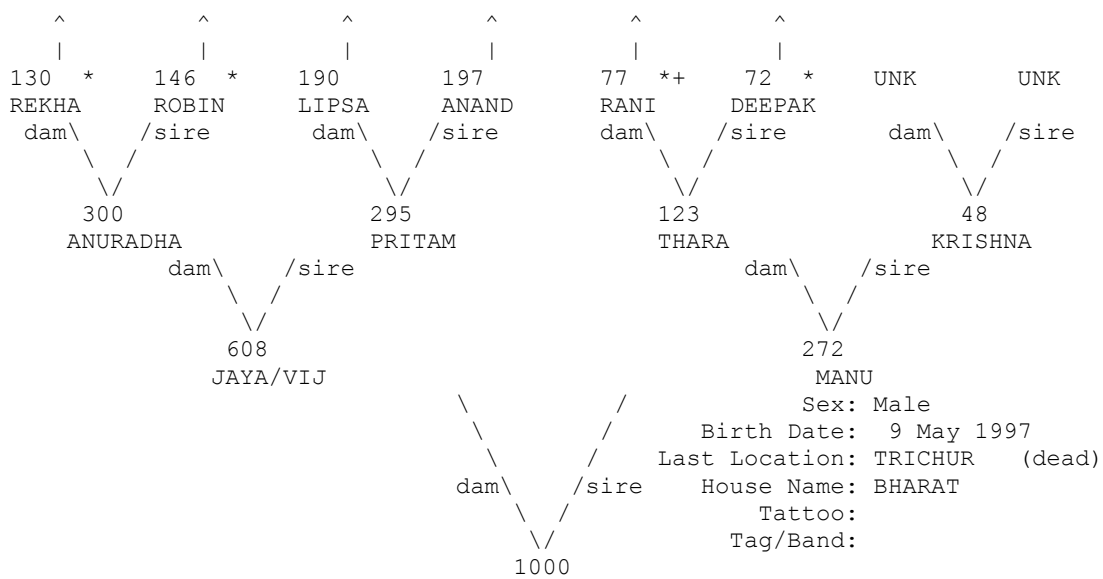

+ Wild-caught... * Appear more than once...
 ^ Pedigree continues beyond top of page...

=====
 Taxon Name: PANTHERA TIGRIS Studbook Number: 1001
 =====

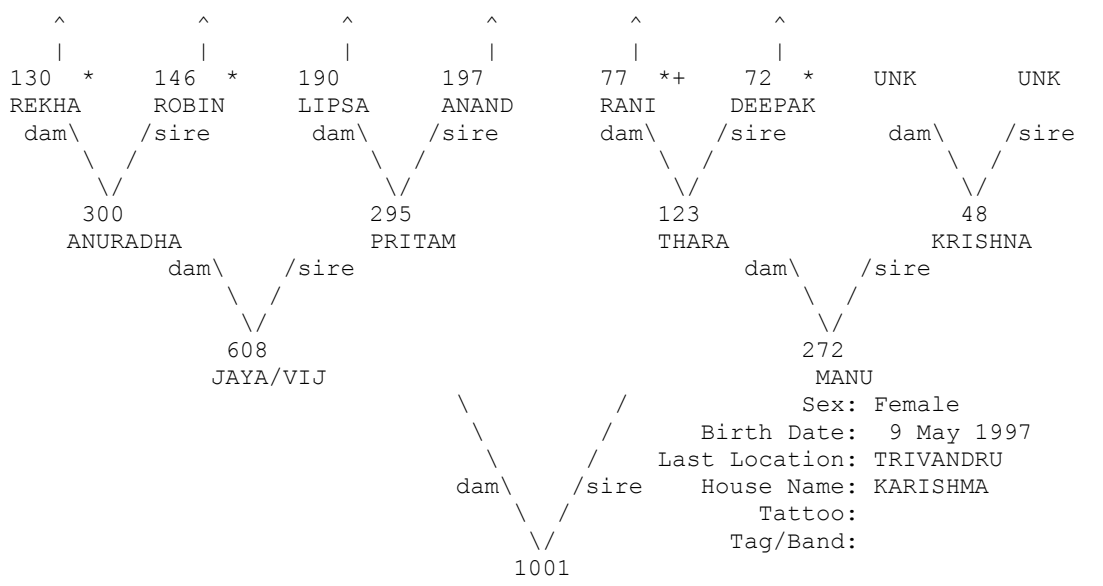

+ Wild-caught... * Appear more than once...
 ^ Pedigree continues beyond top of page...

=====
 Taxon Name: PANTHERA TIGRIS Studbook Number: 1005
 =====

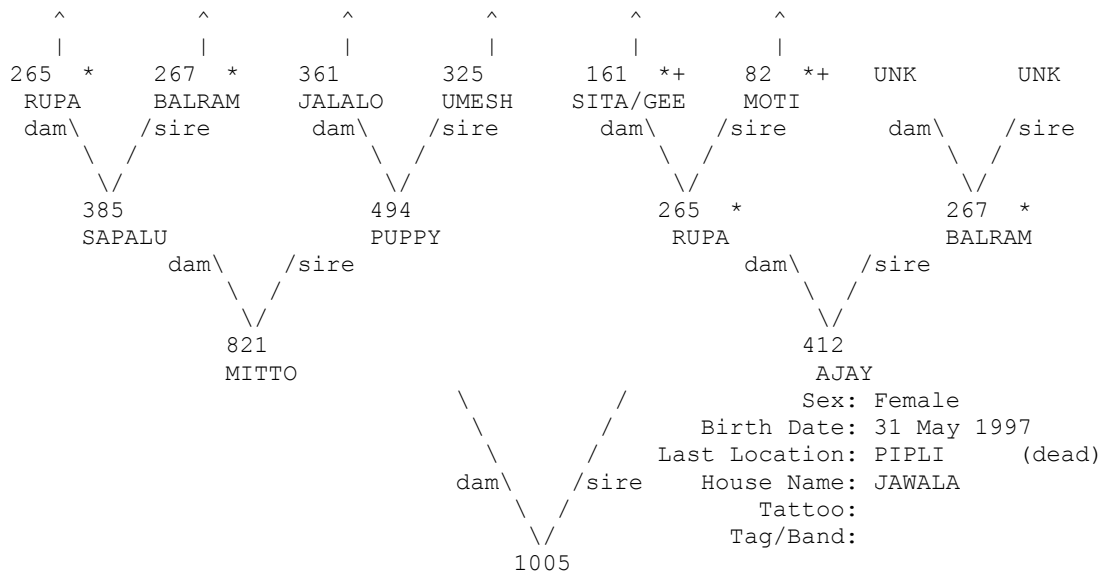

+ Wild-caught... * Appear more than once...
 ^ Pedigree continues beyond top of page...

=====
 Taxon Name: PANTHERA TIGRIS Studbook Number: 1006
 =====

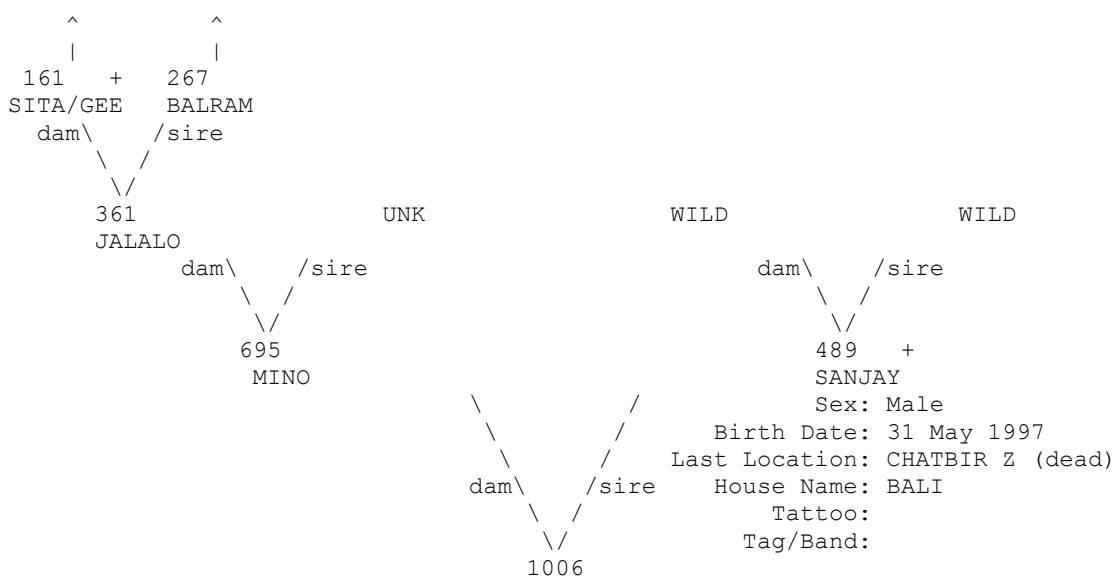

+ Wild-caught...
 ^ Pedigree continues beyond top of page...

=====
 Taxon Name: PANTHERA TIGRIS Studbook Number: 1007
 =====

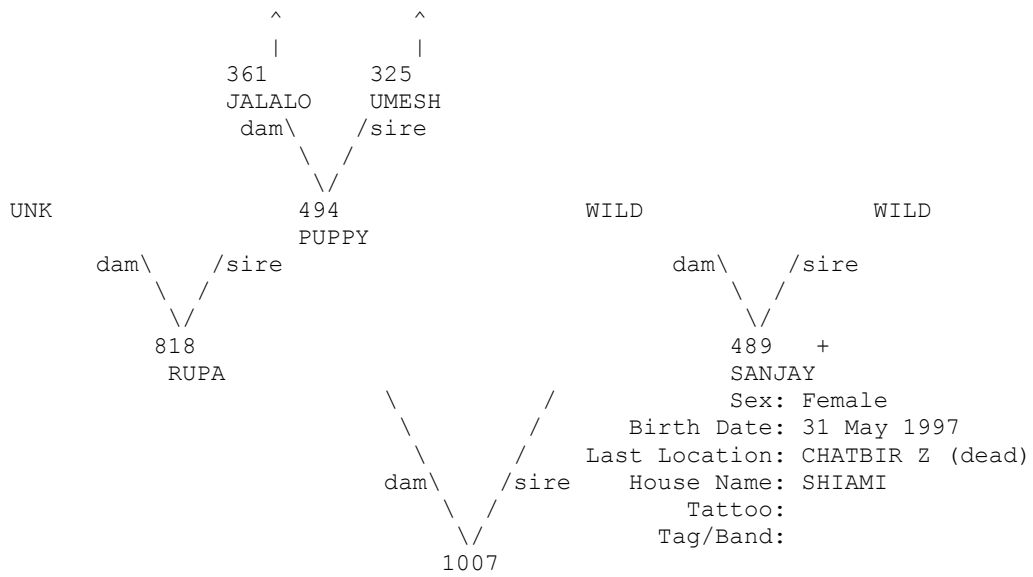

+ Wild-caught... * Appear more than once...
 ^ Pedigree continues beyond top of page...

=====
 Taxon Name: PANTHERA TIGRIS Studbook Number: 1008
 =====

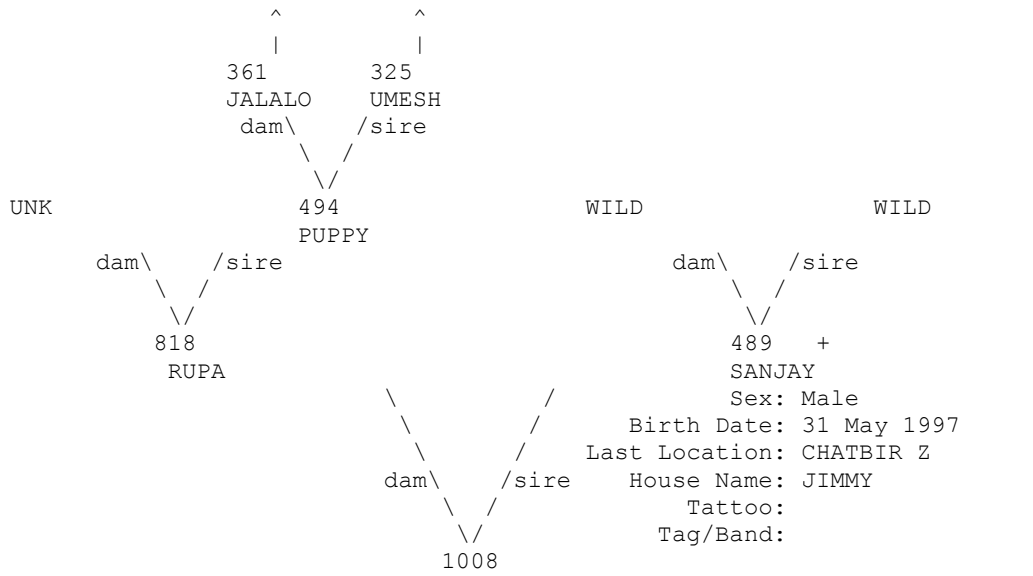

+ Wild-caught... * Appear more than once...
 ^ Pedigree continues beyond top of page...

=====
 Taxon Name: PANTHERA TIGRIS Studbook Number: 1009
 =====

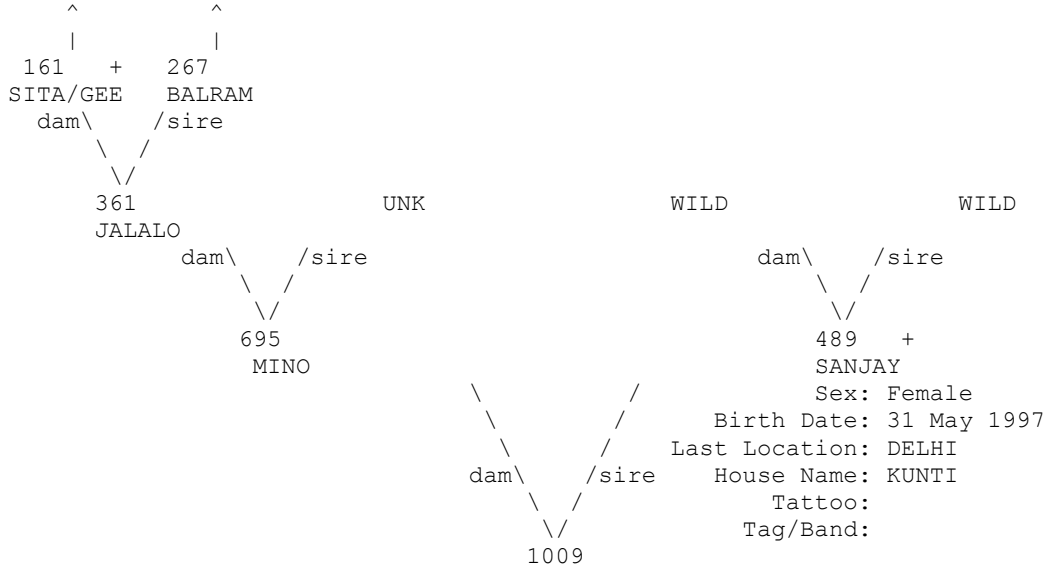

+ Wild-caught...
 ^ Pedigree continues beyond top of page...

=====
 Taxon Name: PANTHERA TIGRIS Studbook Number: 1010
 =====

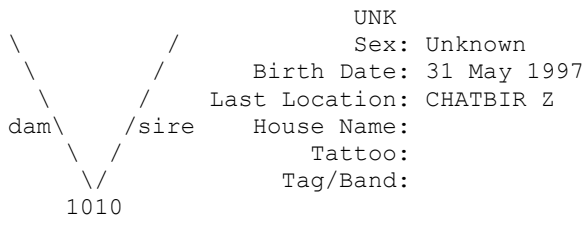

=====
 Taxon Name: PANTHERA TIGRIS Studbook Number: 1011
 =====

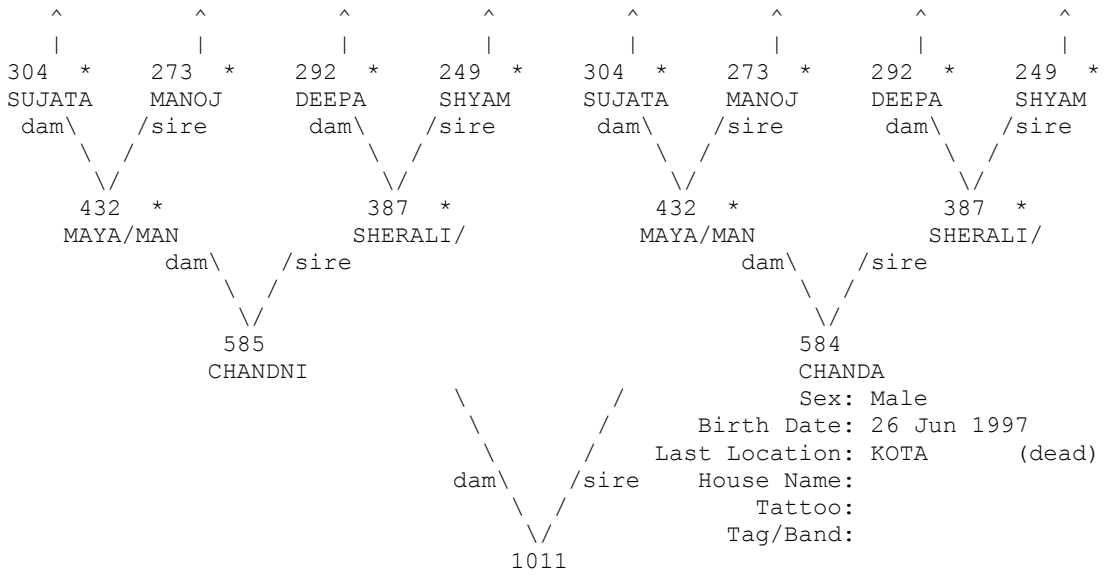

* Appear more than once...
 ^ Pedigree continues beyond top of page...

=====
 Taxon Name: PANTHERA TIGRIS Studbook Number: 1014
 =====

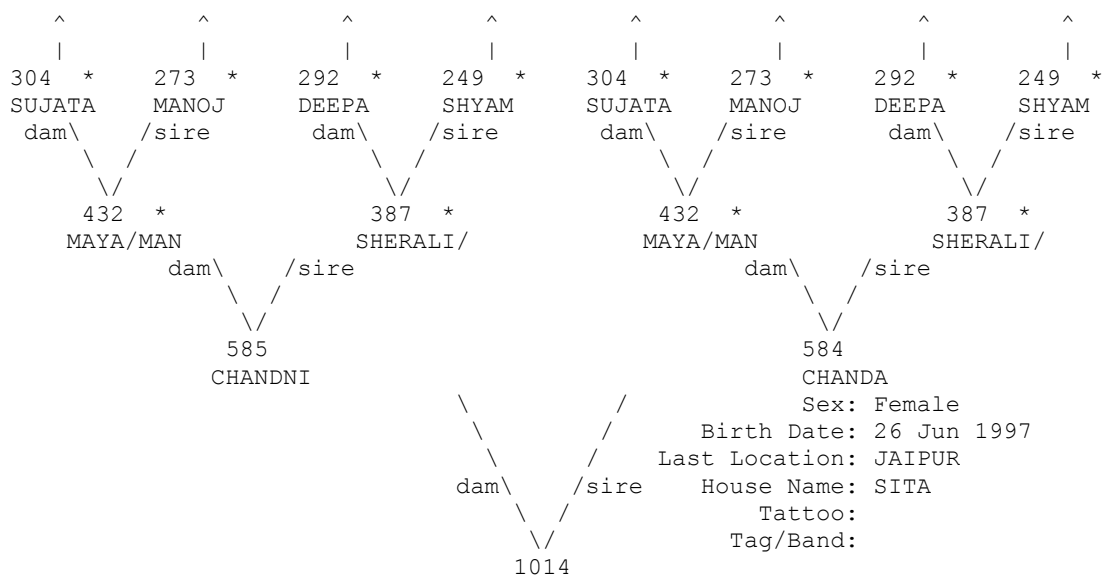

* Appear more than once...
 ^ Pedigree continues beyond top of page...

=====
 Taxon Name: PANTHERA TIGRIS Studbook Number: 1015
 =====

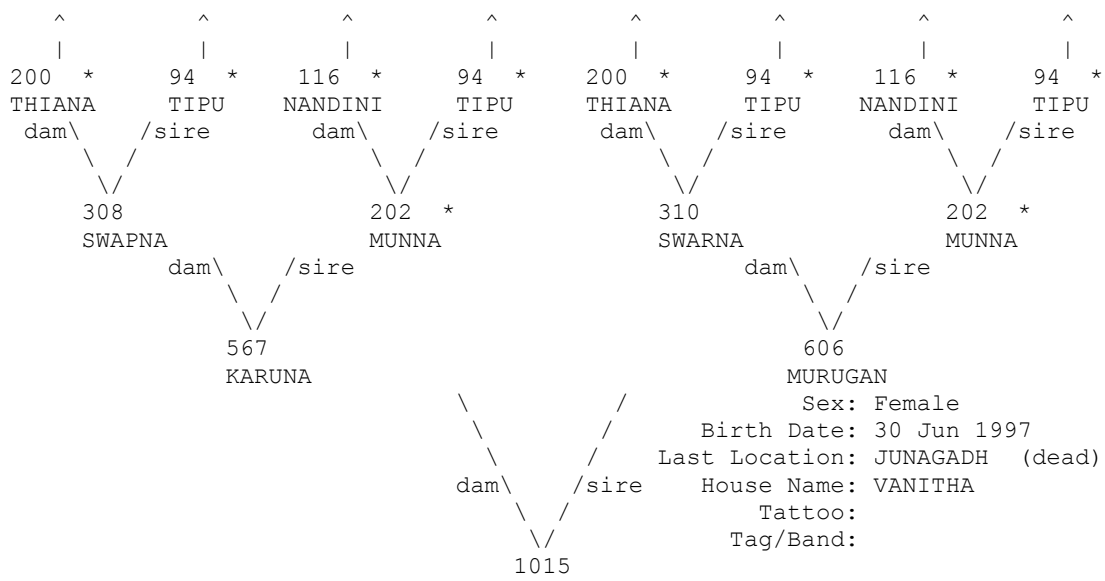

* Appear more than once...
 ^ Pedigree continues beyond top of page...

=====
 Taxon Name: PANTHERA TIGRIS Studbook Number: 1016
 =====

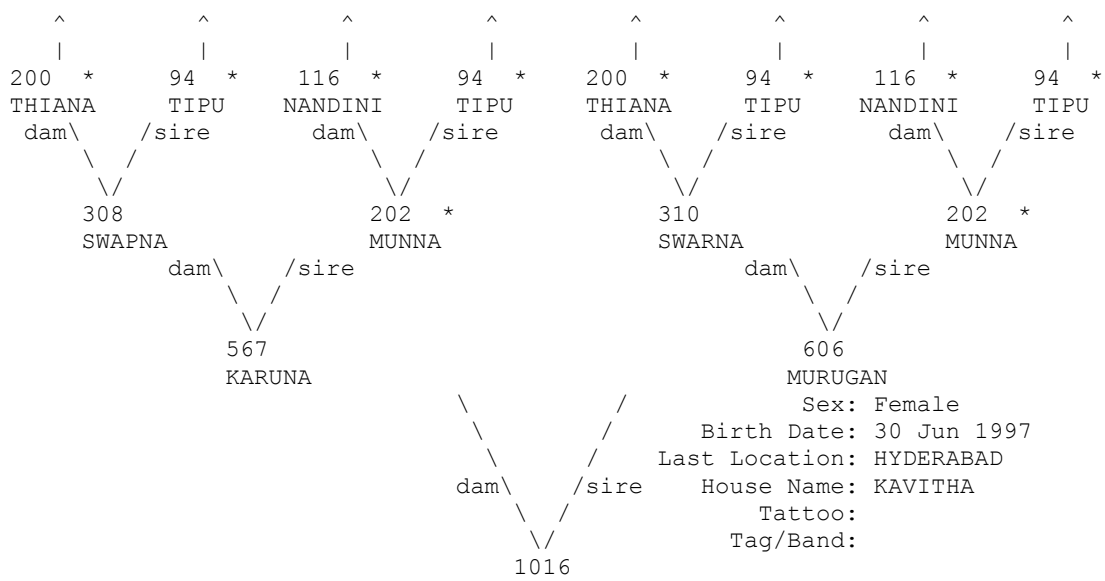

* Appear more than once...
 ^ Pedigree continues beyond top of page...

=====
 Taxon Name: PANTHERA TIGRIS Studbook Number: 1017
 =====

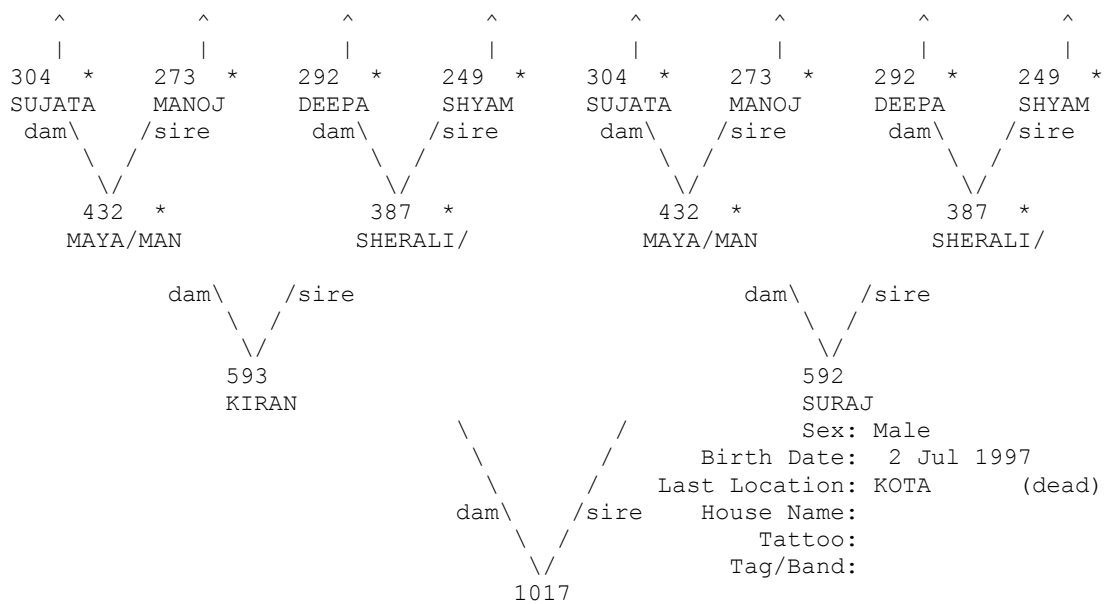

* Appear more than once...
 ^ Pedigree continues beyond top of page...

=====
 Taxon Name: PANTHERA TIGRIS Studbook Number: 1020
 =====

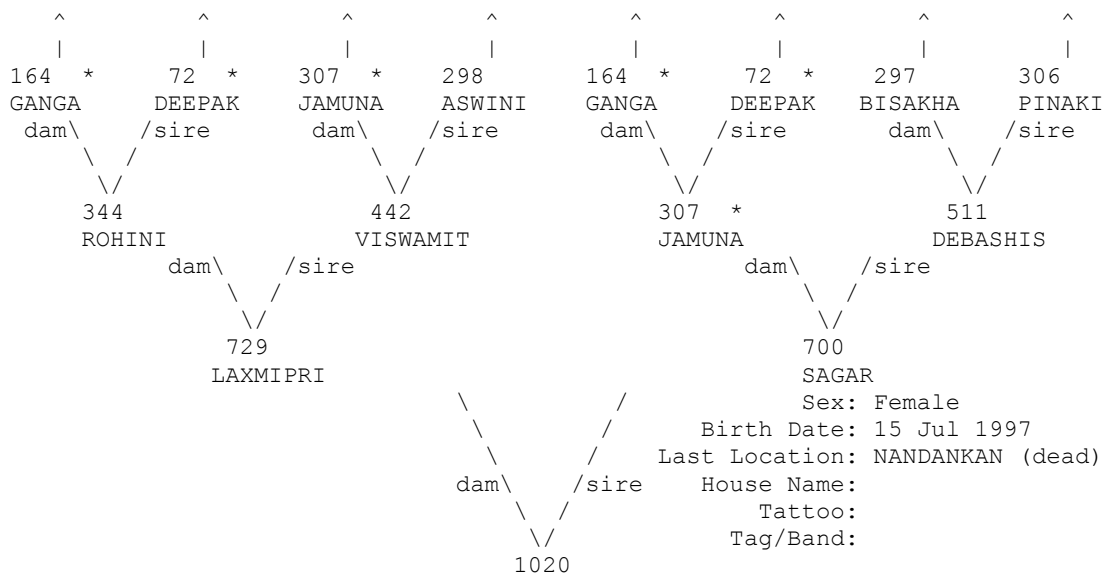

* Appear more than once...
 ^ Pedigree continues beyond top of page...

=====
 Taxon Name: PANTHERA TIGRIS Studbook Number: 1021
 =====

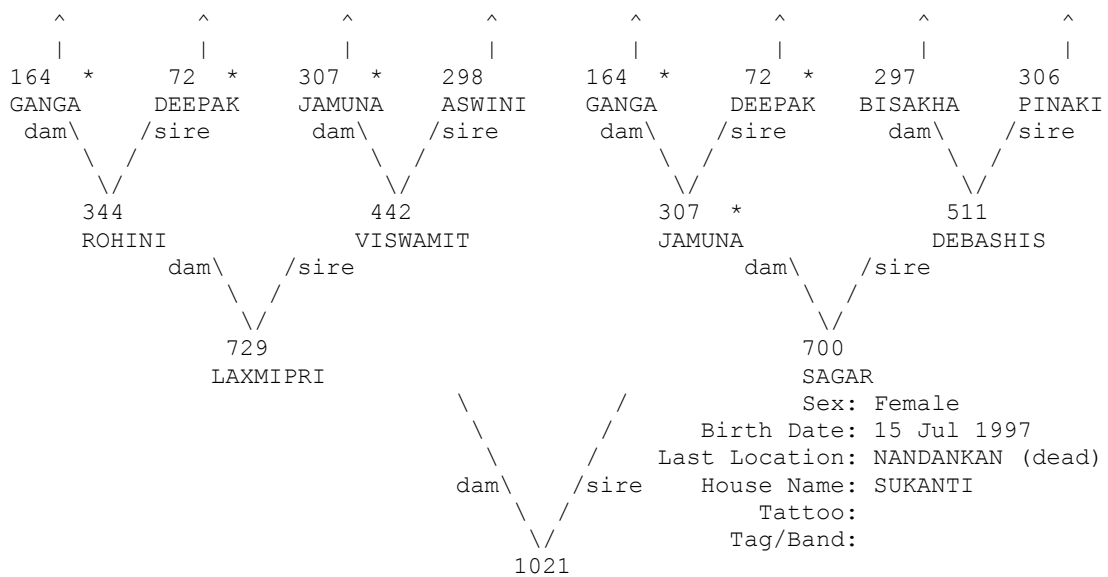

* Appear more than once...
 ^ Pedigree continues beyond top of page...

=====
 Taxon Name: PANTHERA TIGRIS Studbook Number: 1022
 =====

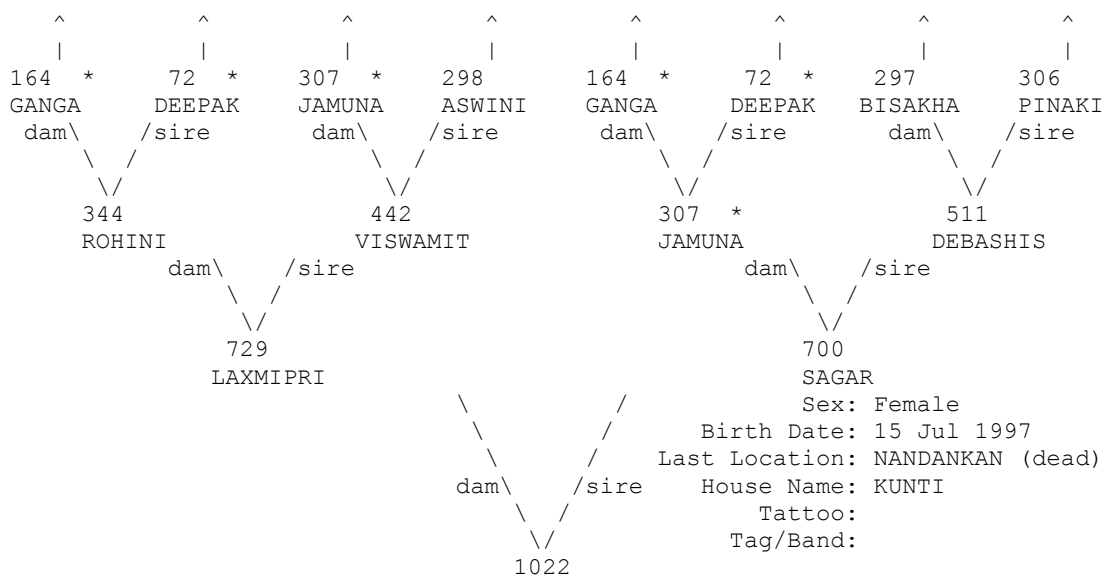

* Appear more than once...
 ^ Pedigree continues beyond top of page...

=====
 Taxon Name: PANTHERA TIGRIS Studbook Number: 1023
 =====

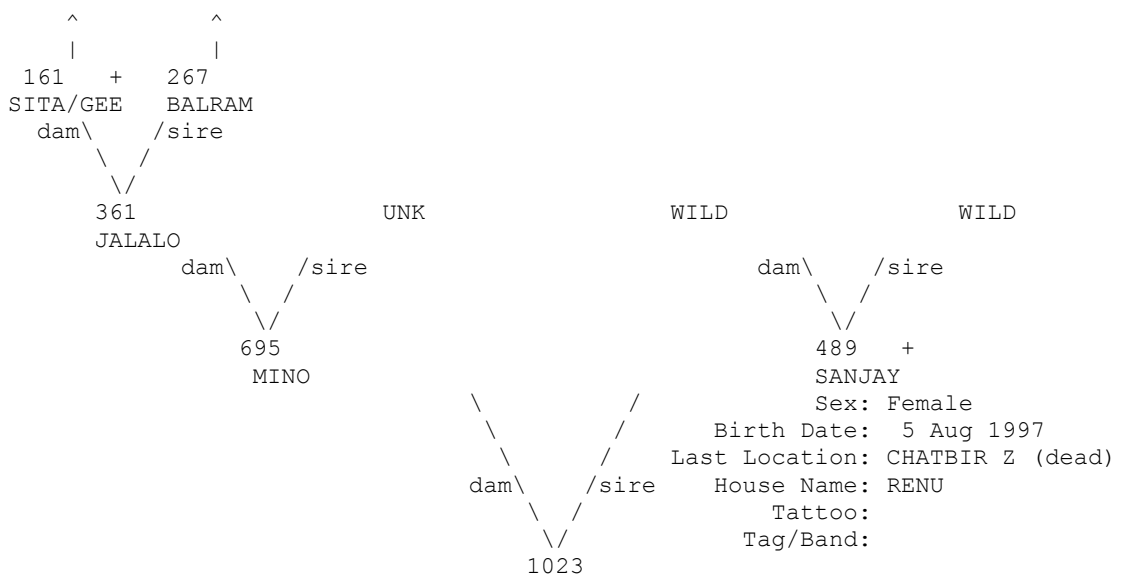

+ Wild-caught...
 ^ Pedigree continues beyond top of page...

=====
 Taxon Name: PANTHERA TIGRIS Studbook Number: 1024
 =====

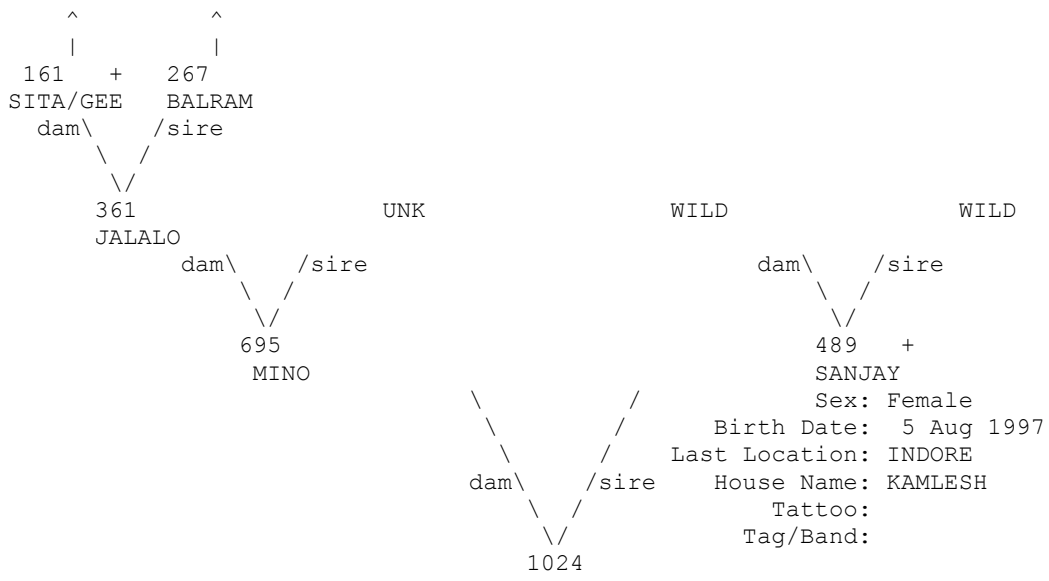

+ Wild-caught...
 ^ Pedigree continues beyond top of page...

=====
 Taxon Name: PANTHERA TIGRIS Studbook Number: 1025
 =====

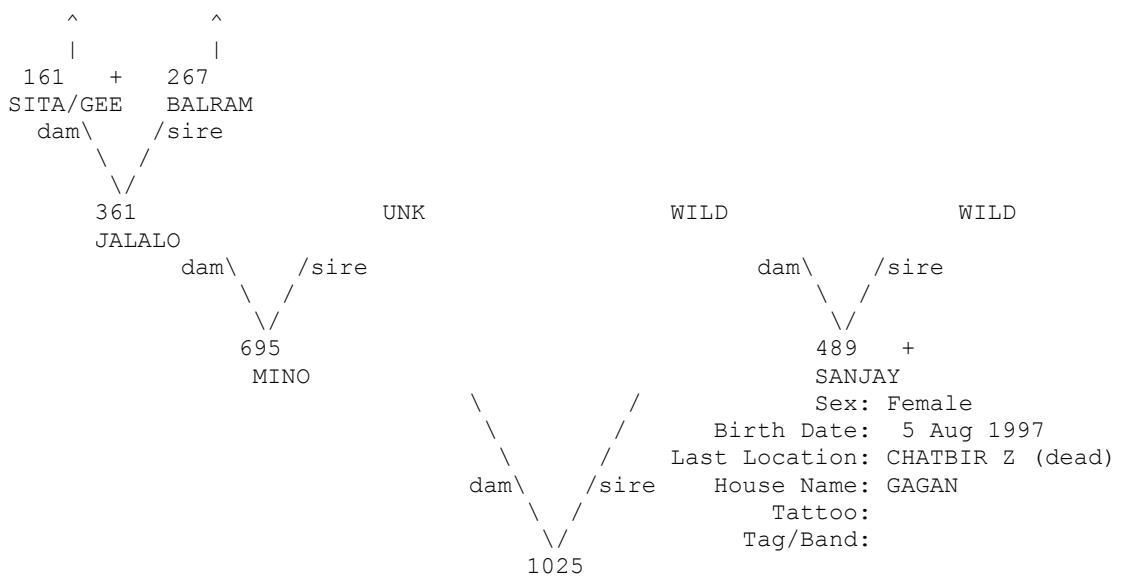

+ Wild-caught...
 ^ Pedigree continues beyond top of page...

=====
Taxon Name: PANTHERA TIGRIS

Studbook Number: 1026
=====

^ ^
| |
161 + 267
SITA/GEE BALRAM

dam\ /sire
 \
 \
 361
 JALALO

UNK

WILD

WILD

dam\ /sire
 \
 \
 695
 MINO

dam\ /sire
 \
 \
 489 +
 SANJAY

Sex: Male
Birth Date: 5 Aug 1997
Last Location: CHATBIR Z
House Name: FATTU
Tattoo:
Tag/Band:

dam\ /sire
 \
 \
 1026

+ Wild-caught...

^ Pedigree continues beyond top of page...

=====
Taxon Name: PANTHERA TIGRIS

Studbook Number: 1027
=====

UNK

UNK

dam\ /sire
 \
 \
 1027

Sex: Male
Birth Date: 5 Aug 1997
Last Location: CHATBIR Z
House Name:
Tattoo:
Tag/Band:

=====
 Taxon Name: PANTHERA TIGRIS Studbook Number: 1028
 =====

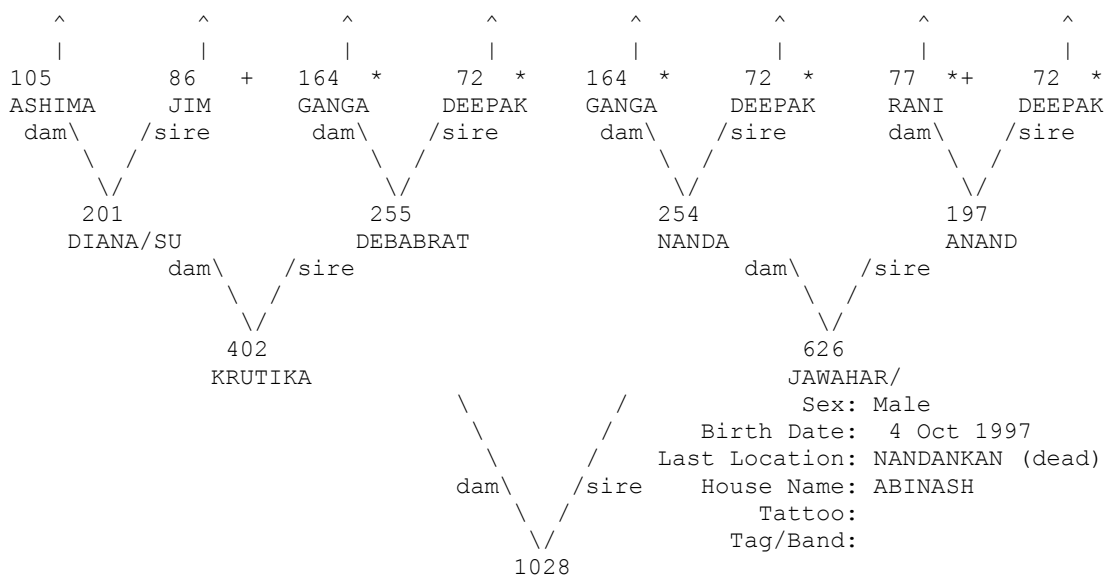

+ Wild-caught... * Appear more than once...
 ^ Pedigree continues beyond top of page...

=====
 Taxon Name: PANTHERA TIGRIS Studbook Number: 1029
 =====

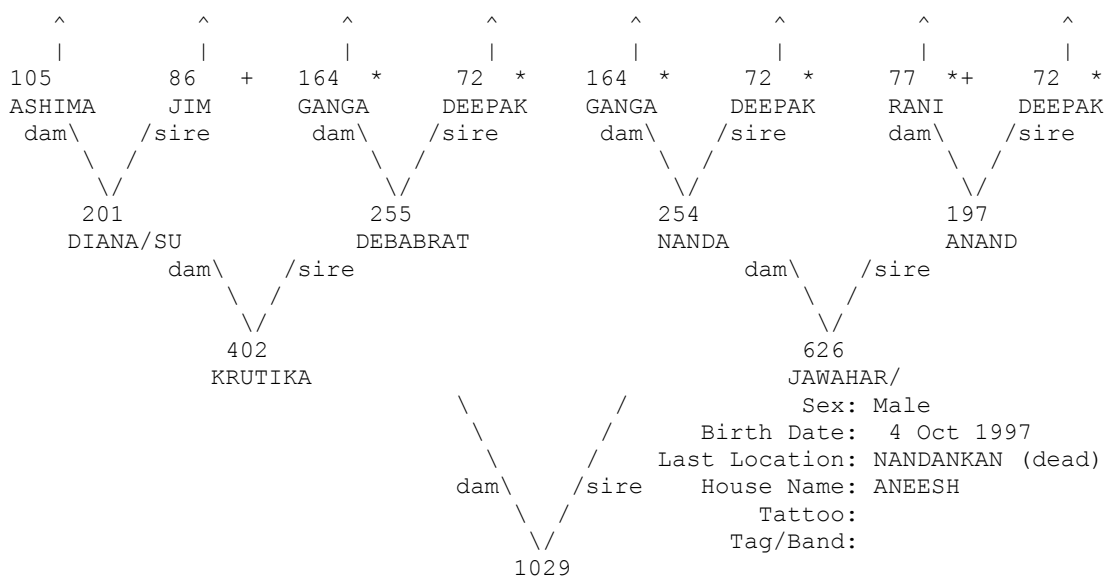

+ Wild-caught... * Appear more than once...
 ^ Pedigree continues beyond top of page...

=====
 Taxon Name: PANTHERA TIGRIS Studbook Number: 1030
 =====

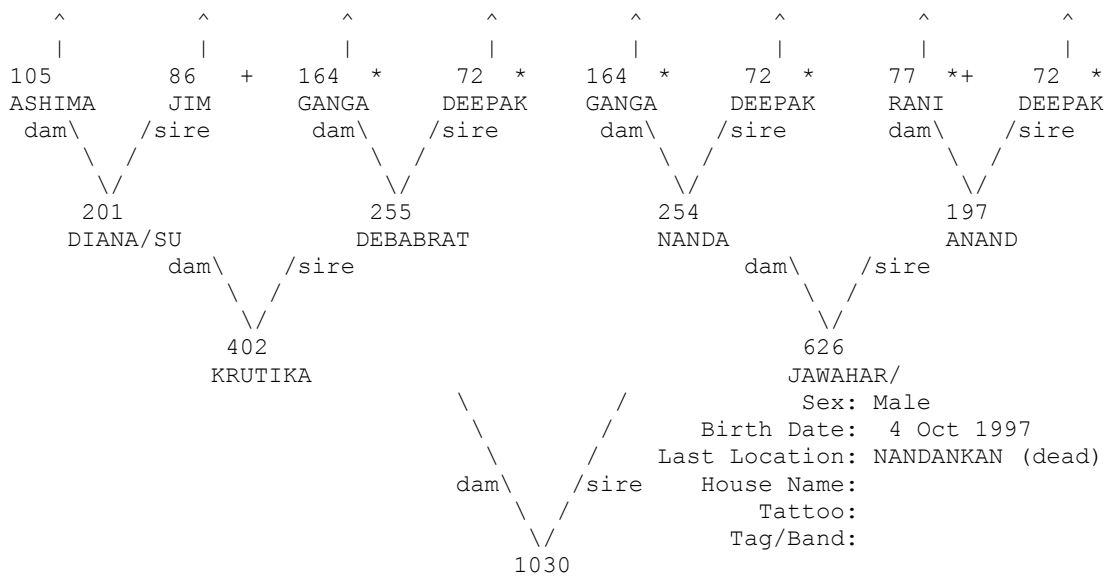

+ Wild-caught... * Appear more than once...
 ^ Pedigree continues beyond top of page...

=====
 Taxon Name: PANTHERA TIGRIS Studbook Number: 1031
 =====

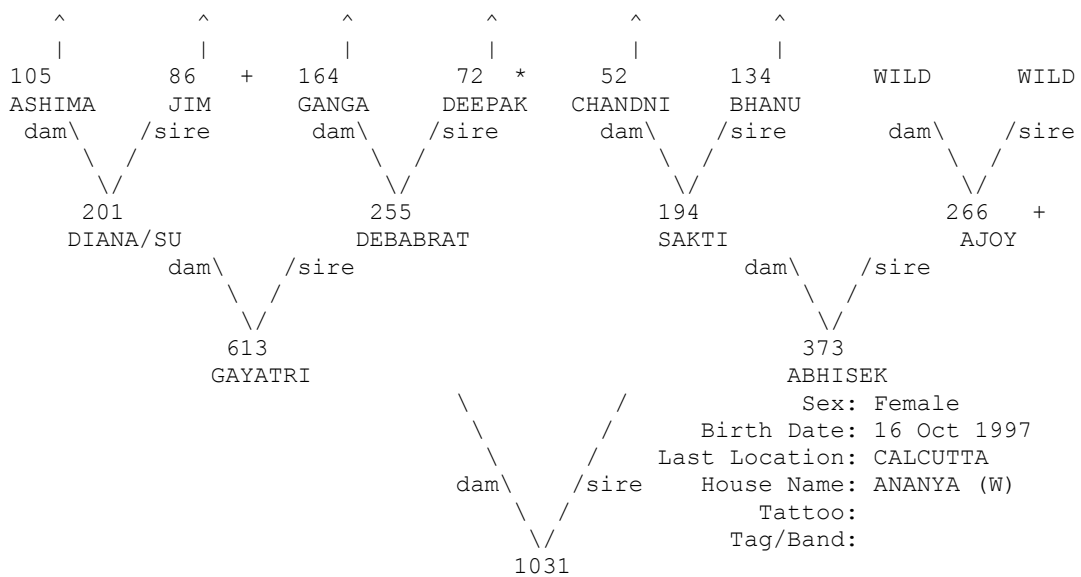

+ Wild-caught... * Appear more than once...
 ^ Pedigree continues beyond top of page...

=====
 Taxon Name: PANTHERA TIGRIS Studbook Number: 1032
 =====

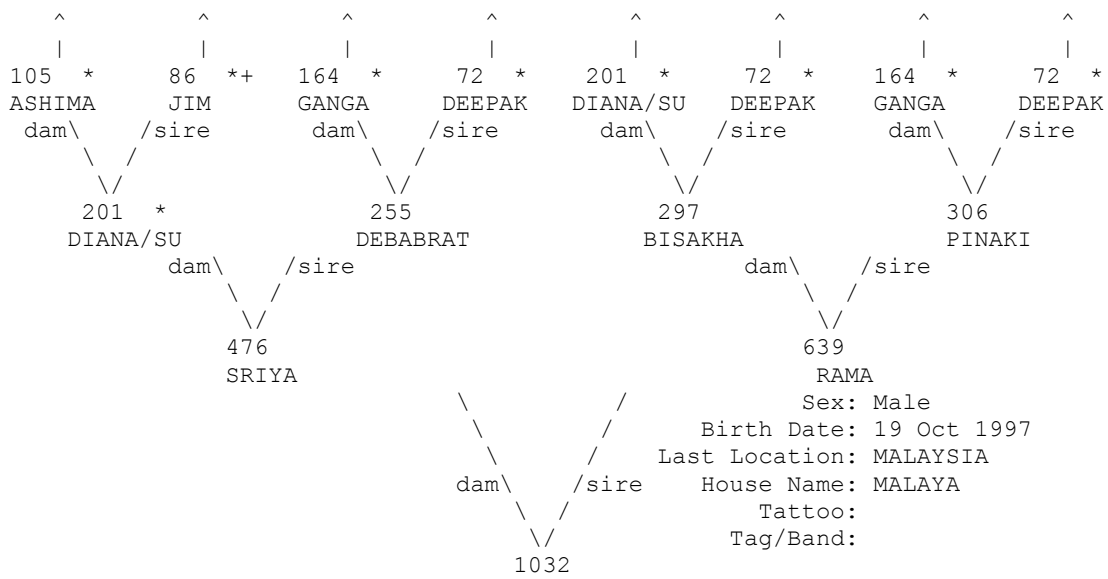

+ Wild-caught... * Appear more than once...
 ^ Pedigree continues beyond top of page...

=====
 Taxon Name: PANTHERA TIGRIS Studbook Number: 1033
 =====

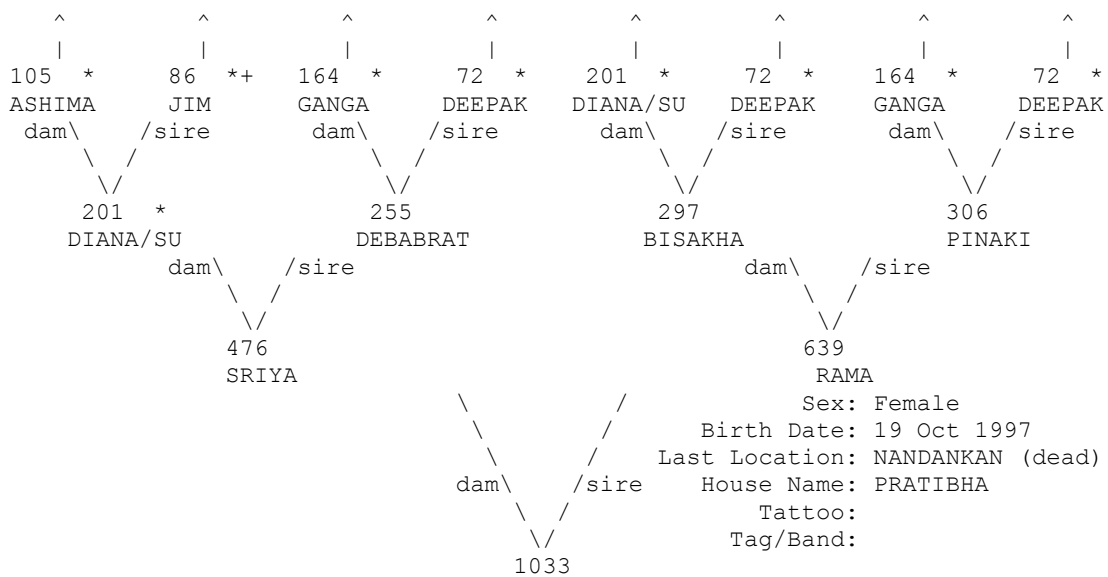

+ Wild-caught... * Appear more than once...
 ^ Pedigree continues beyond top of page...

=====
 Taxon Name: PANTHERA TIGRIS Studbook Number: 1034
 =====

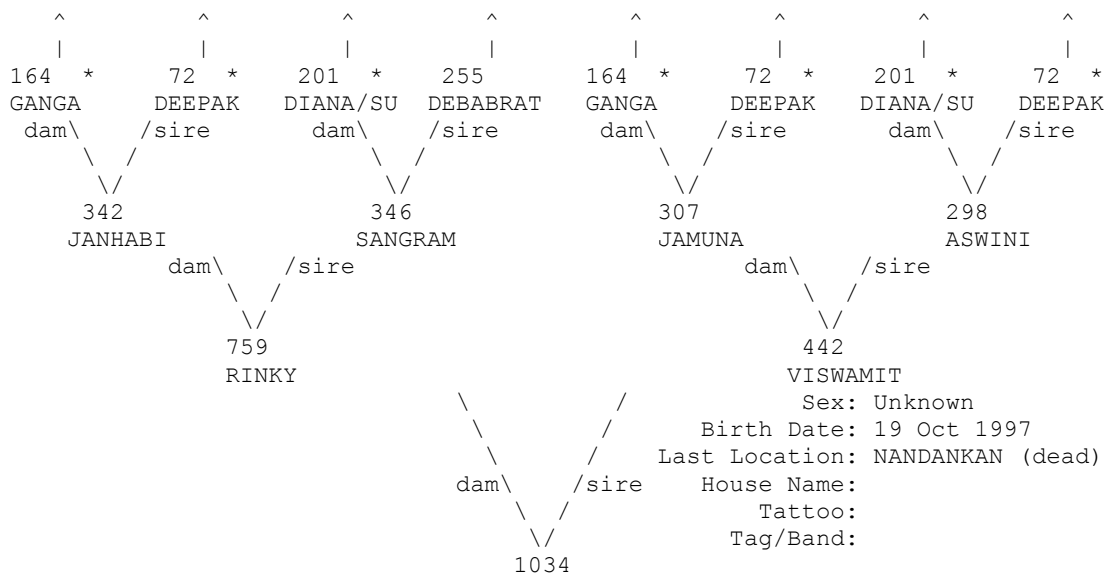

* Appear more than once...
 ^ Pedigree continues beyond top of page...

=====
 Taxon Name: PANTHERA TIGRIS Studbook Number: 1035
 =====

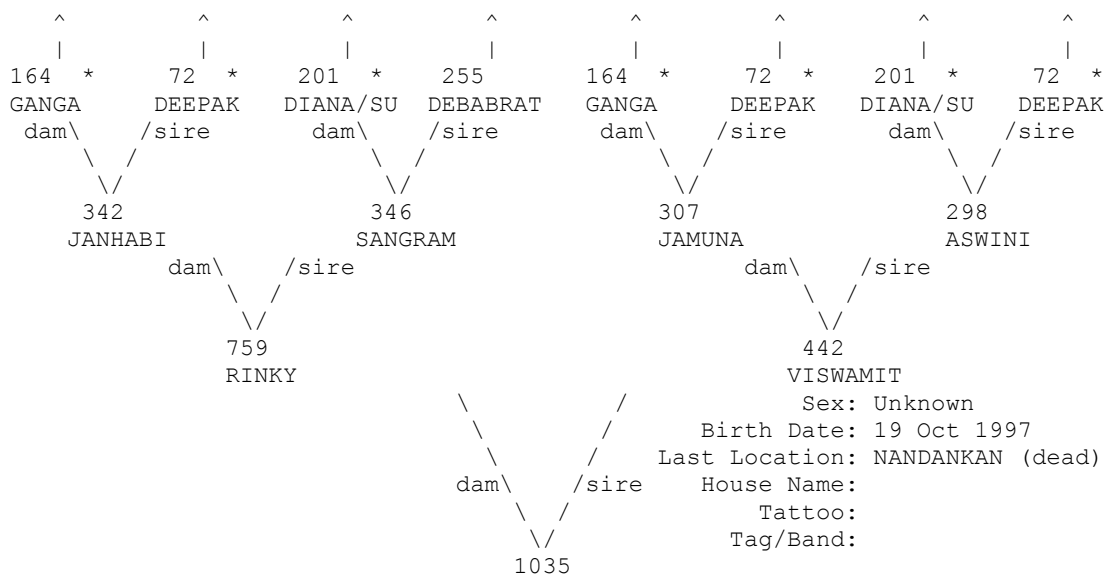

* Appear more than once...
 ^ Pedigree continues beyond top of page...

=====
 Taxon Name: PANTHERA TIGRIS Studbook Number: 1036
 =====

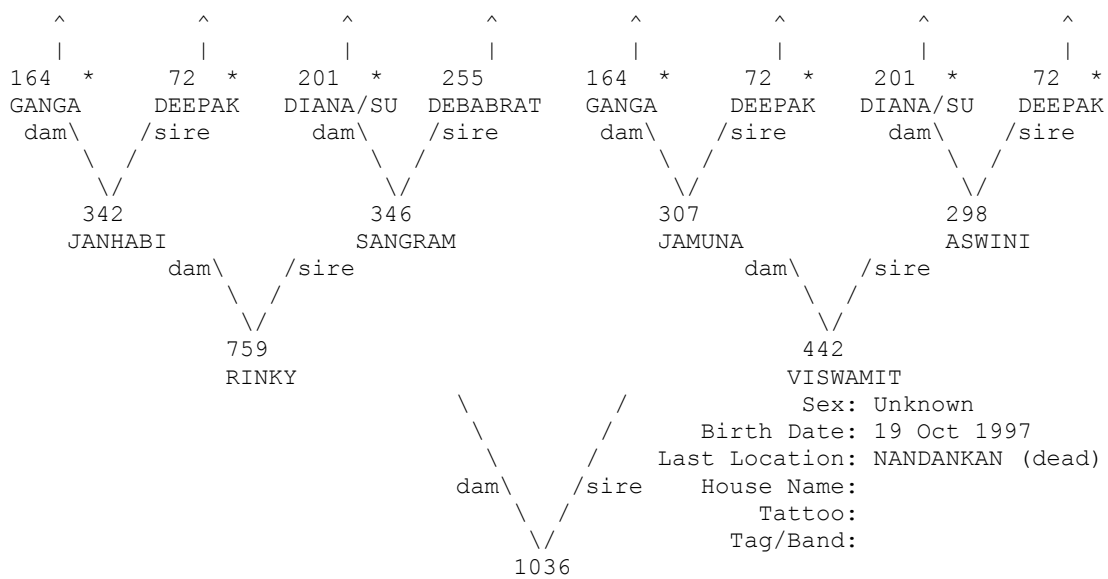

* Appear more than once...
 ^ Pedigree continues beyond top of page...

=====
 Taxon Name: PANTHERA TIGRIS Studbook Number: 1037
 =====

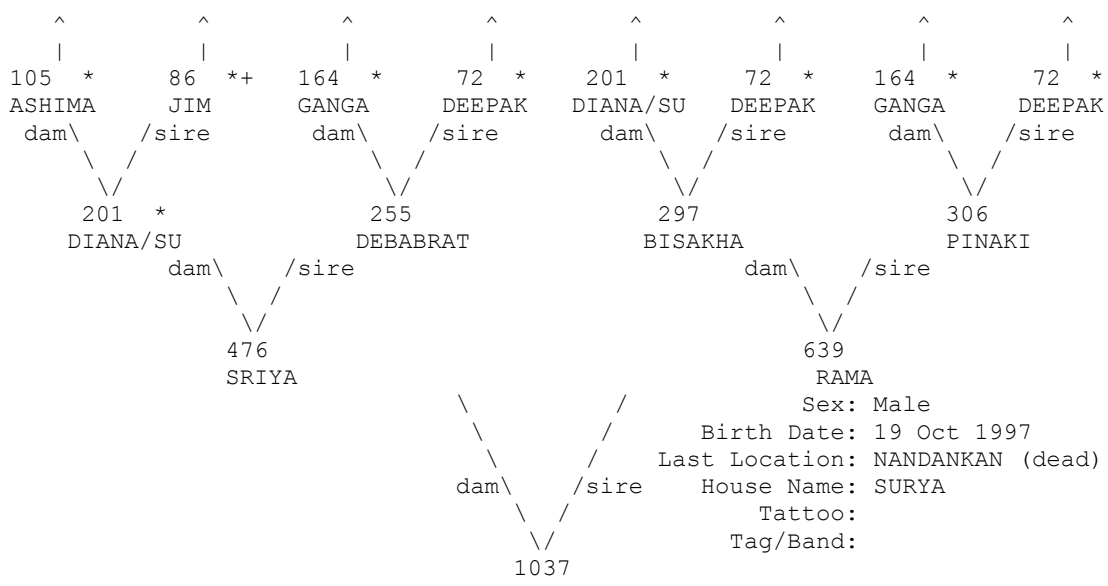

+ Wild-caught... * Appear more than once...
 ^ Pedigree continues beyond top of page...

=====
 Taxon Name: PANTHERA TIGRIS Studbook Number: 1038
 =====

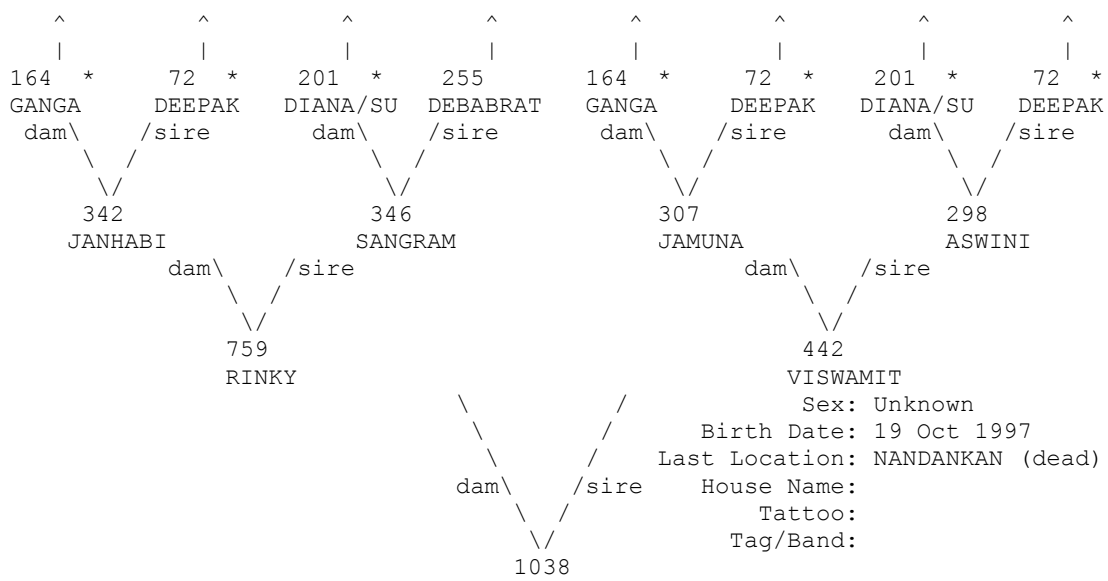

* Appear more than once...
 ^ Pedigree continues beyond top of page...

=====
 Taxon Name: PANTHERA TIGRIS Studbook Number: 1039
 =====

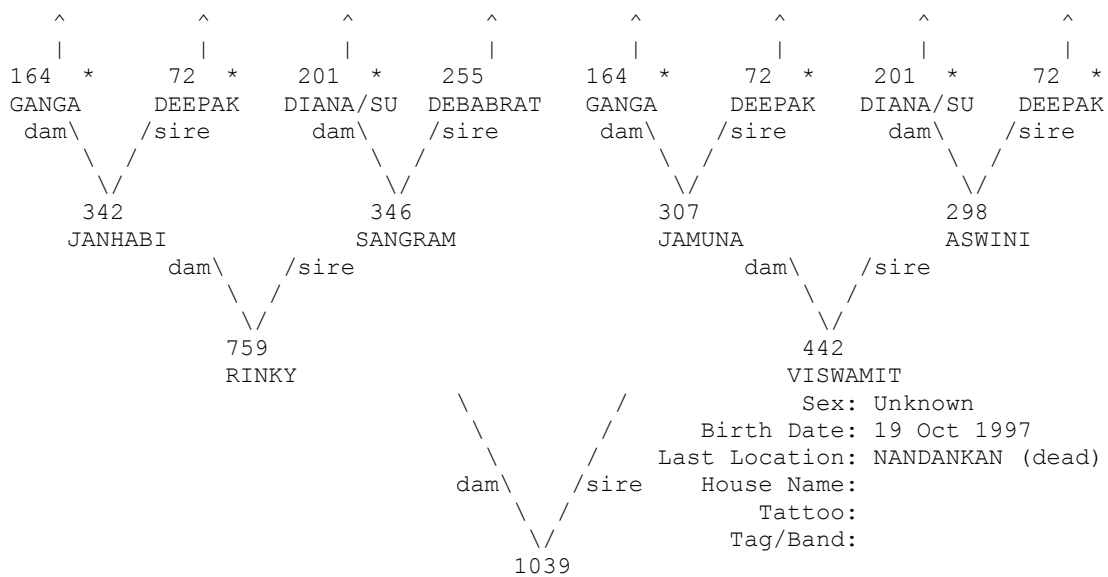

* Appear more than once...
 ^ Pedigree continues beyond top of page...

=====
 Taxon Name: PANTHERA TIGRIS Studbook Number: 1042
 =====

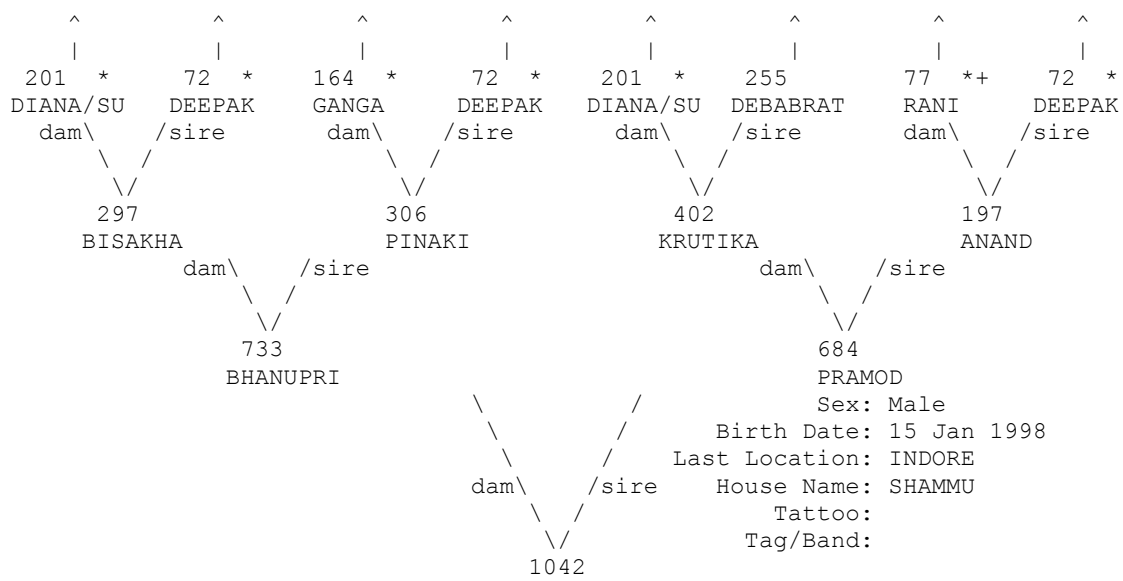

+ Wild-caught... * Appear more than once...
 ^ Pedigree continues beyond top of page...

=====
 Taxon Name: PANTHERA TIGRIS Studbook Number: 1043
 =====

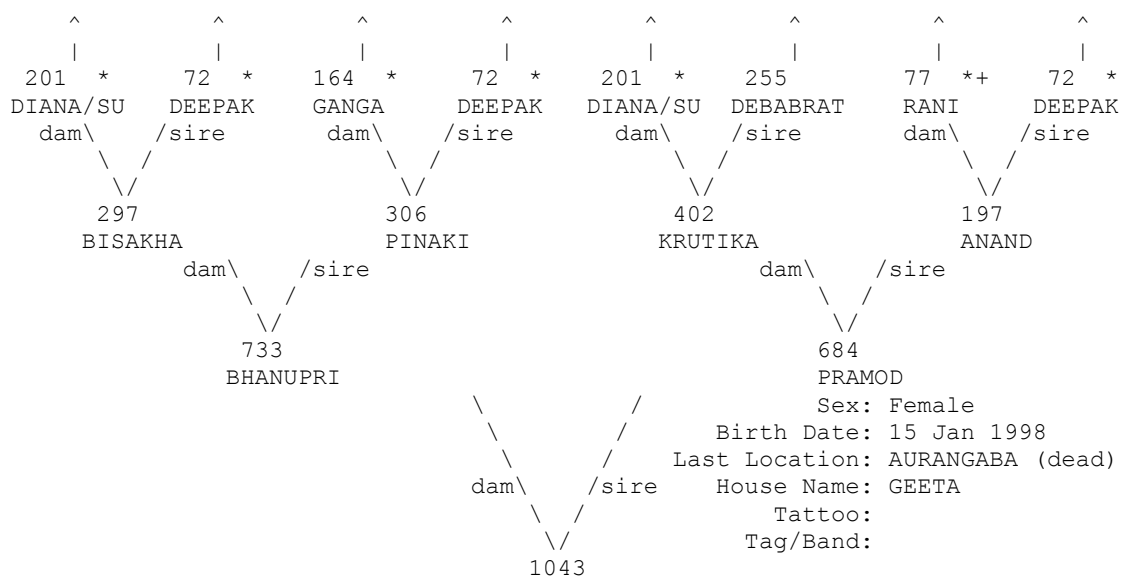

+ Wild-caught... * Appear more than once...
 ^ Pedigree continues beyond top of page...

=====
 Taxon Name: PANTHERA TIGRIS Studbook Number: 1044
 =====

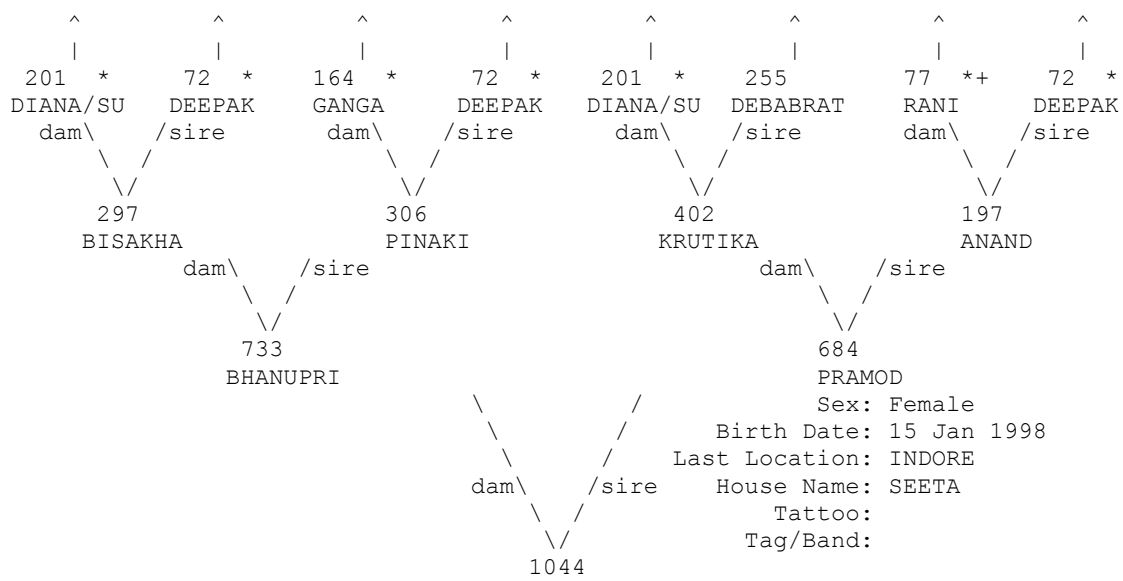

+ Wild-caught... * Appear more than once...
 ^ Pedigree continues beyond top of page...

=====
 Taxon Name: PANTHERA TIGRIS Studbook Number: 1045
 =====

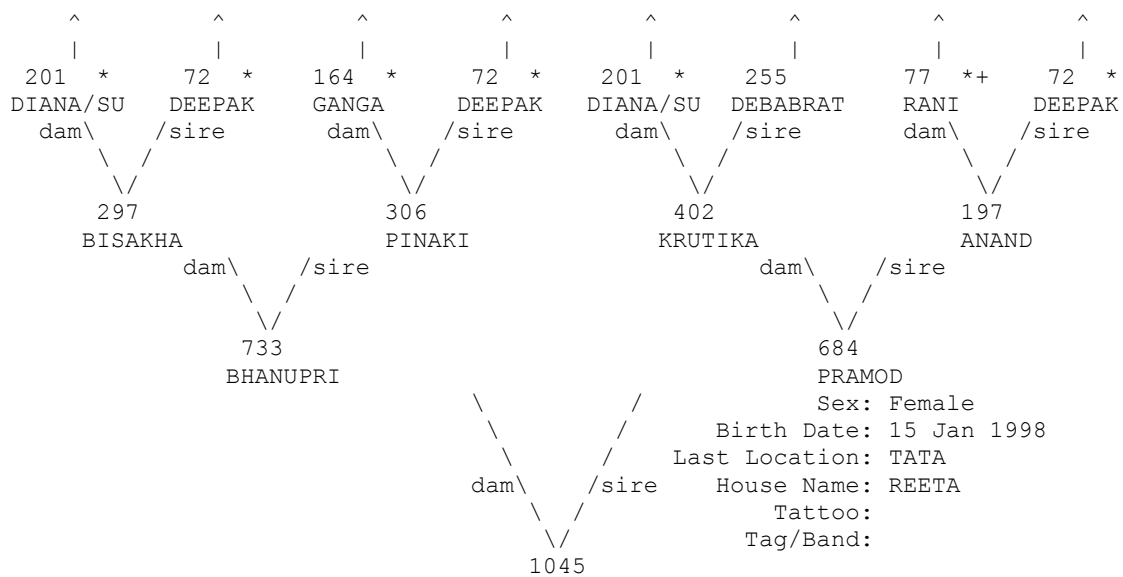

+ Wild-caught... * Appear more than once...
 ^ Pedigree continues beyond top of page...

=====
 Taxon Name: PANTHERA TIGRIS Studbook Number: 1046
 =====

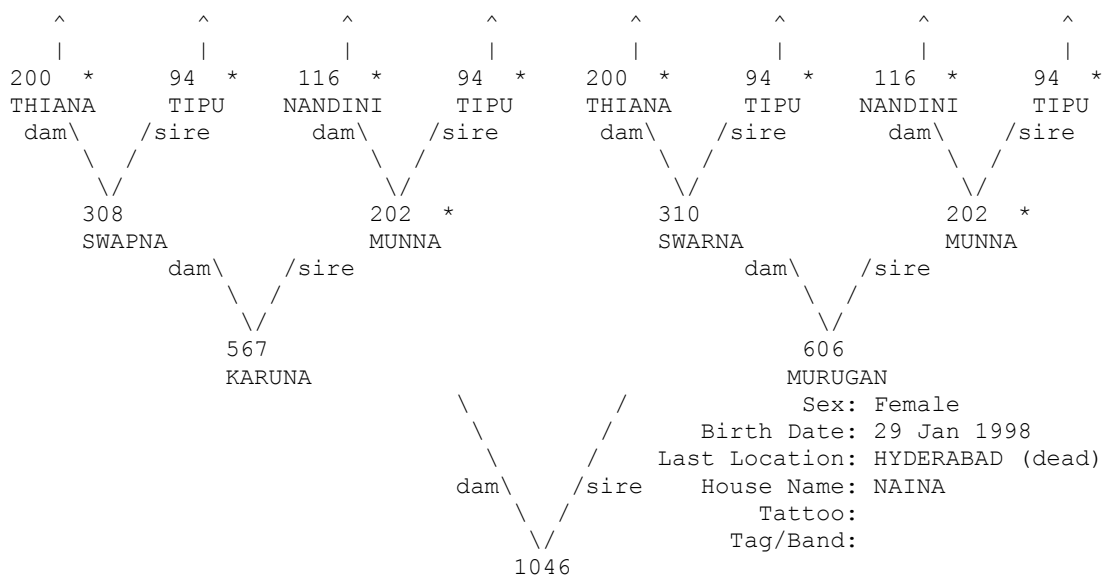

* Appear more than once...
 ^ Pedigree continues beyond top of page...

=====
 Taxon Name: PANTHERA TIGRIS Studbook Number: 1047
 =====

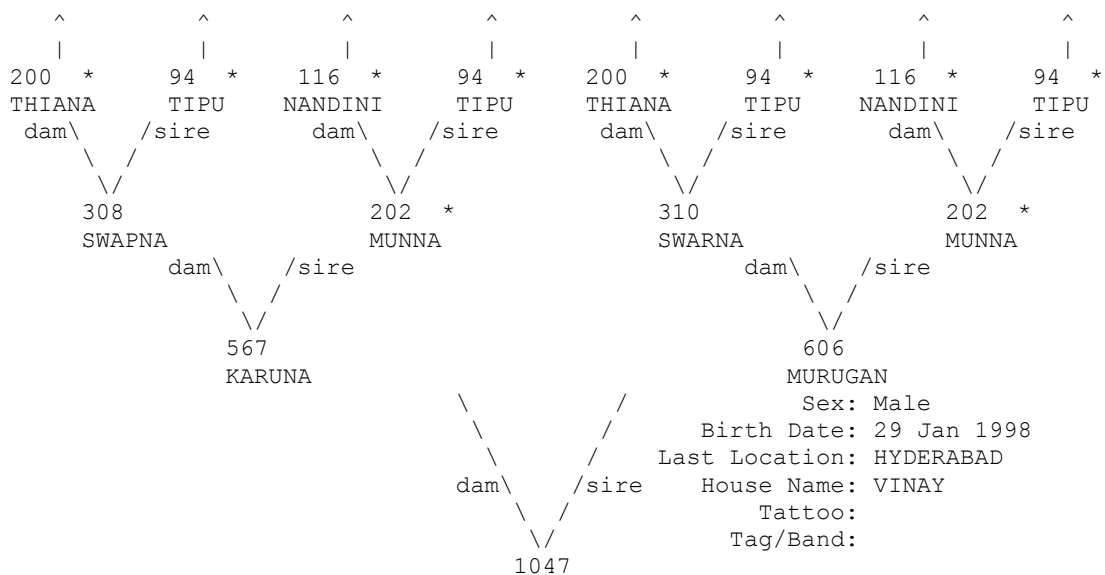

* Appear more than once...
 ^ Pedigree continues beyond top of page...

=====
 Taxon Name: PANTHERA TIGRIS Studbook Number: 1048
 =====

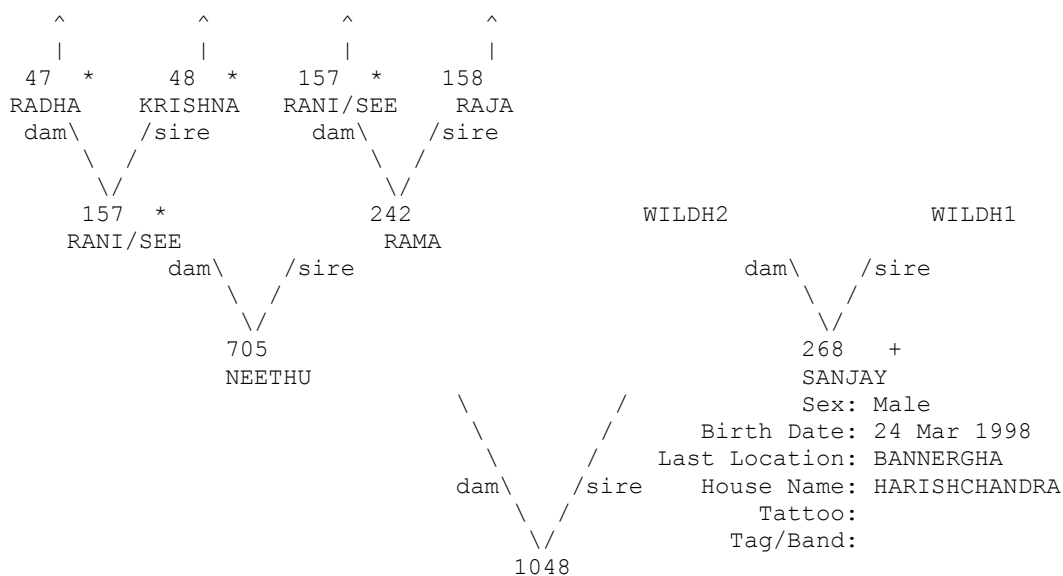

+ Wild-caught... * Appear more than once...
 ^ Pedigree continues beyond top of page...

=====
 Taxon Name: PANTHERA TIGRIS Studbook Number: 1049
 =====

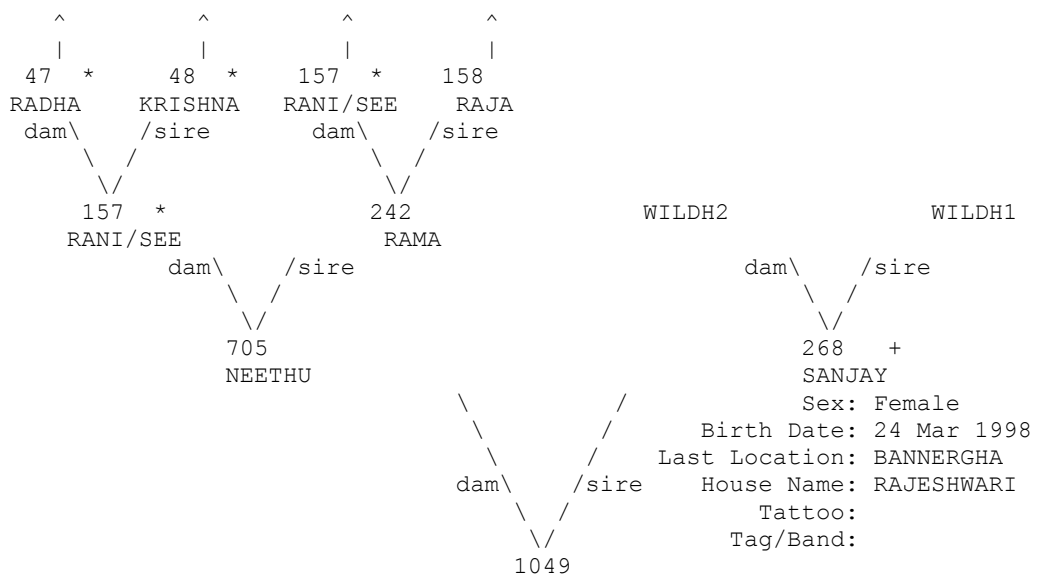

+ Wild-caught... * Appear more than once...
 ^ Pedigree continues beyond top of page...

=====
 Taxon Name: PANTHERA TIGRIS Studbook Number: 1050
 =====

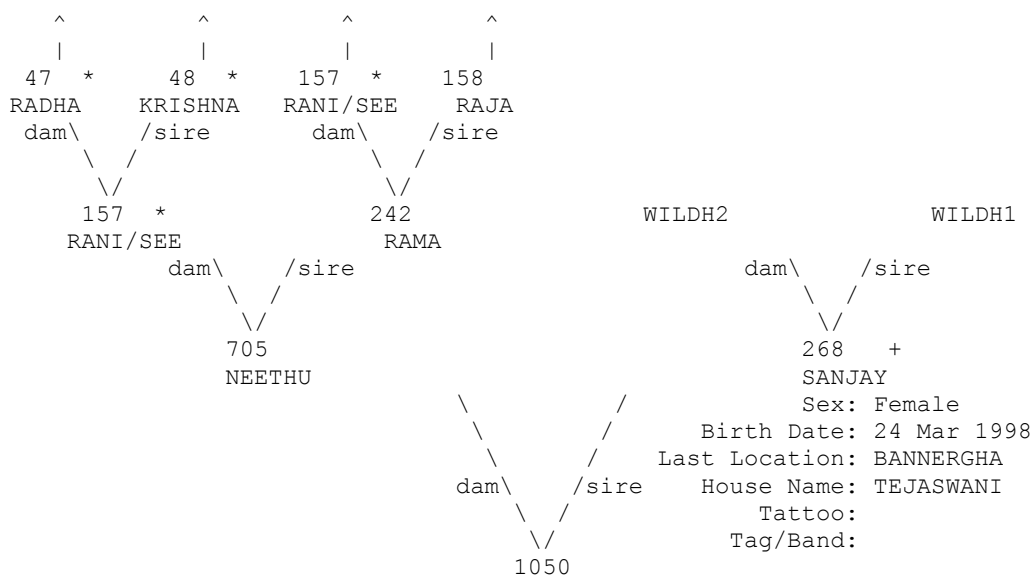

+ Wild-caught... * Appear more than once...
 ^ Pedigree continues beyond top of page...

=====
 Taxon Name: PANTHERA TIGRIS Studbook Number: 1051
 =====

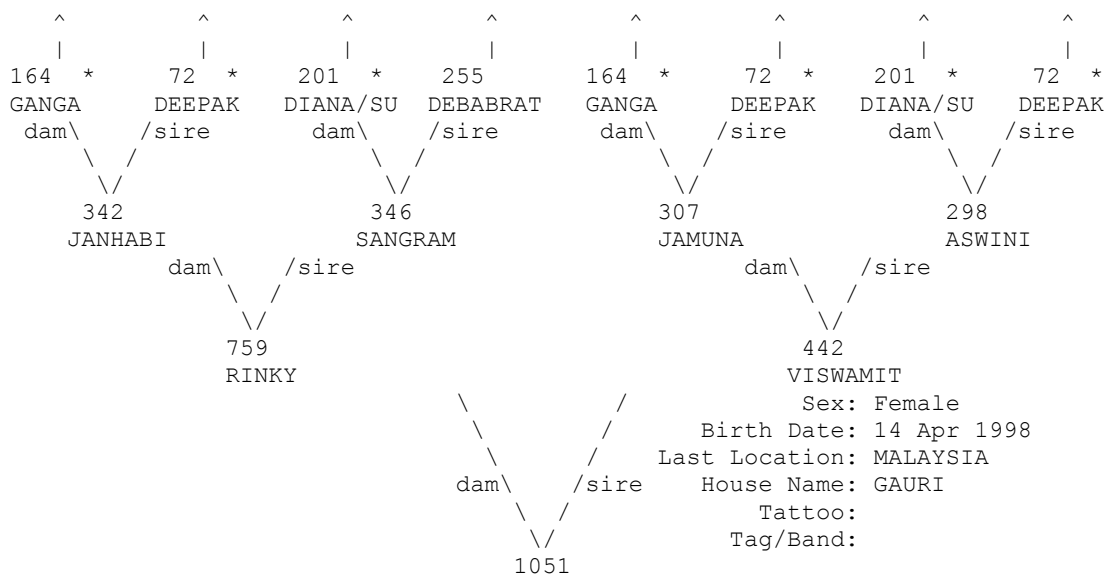

* Appear more than once...
 ^ Pedigree continues beyond top of page...

=====
 Taxon Name: PANTHERA TIGRIS Studbook Number: 1052
 =====

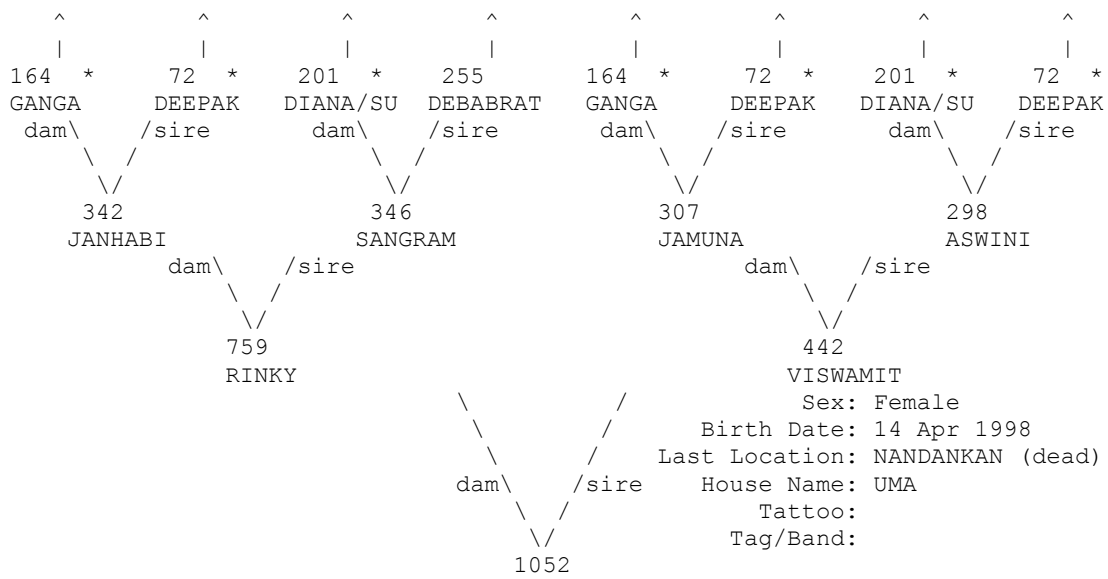

* Appear more than once...
 ^ Pedigree continues beyond top of page...

=====
 Taxon Name: PANTHERA TIGRIS Studbook Number: 1053
 =====

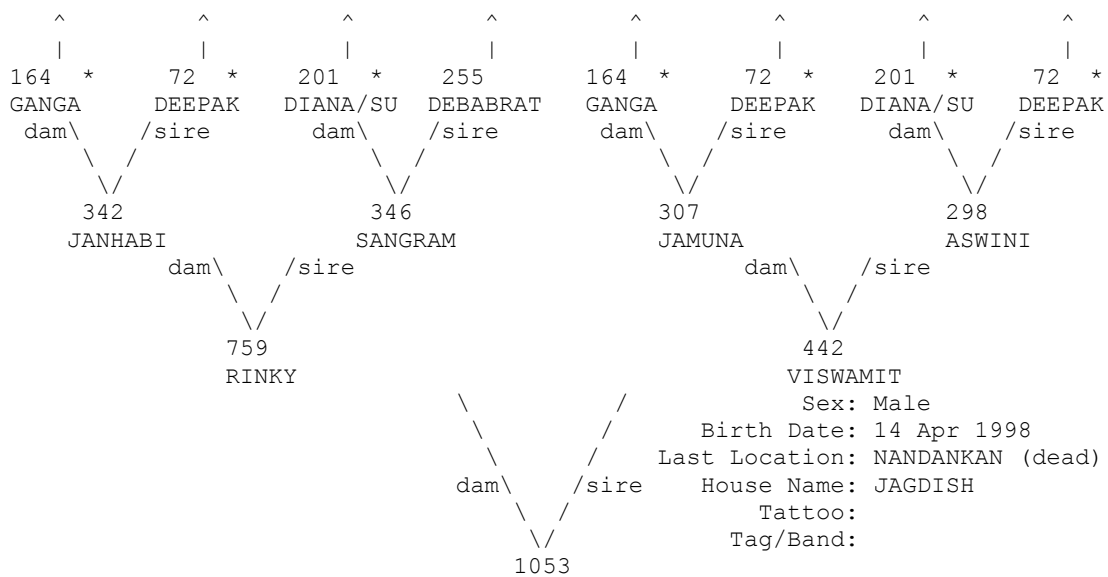

* Appear more than once...
 ^ Pedigree continues beyond top of page...

=====
 Taxon Name: PANTHERA TIGRIS Studbook Number: 1054
 =====

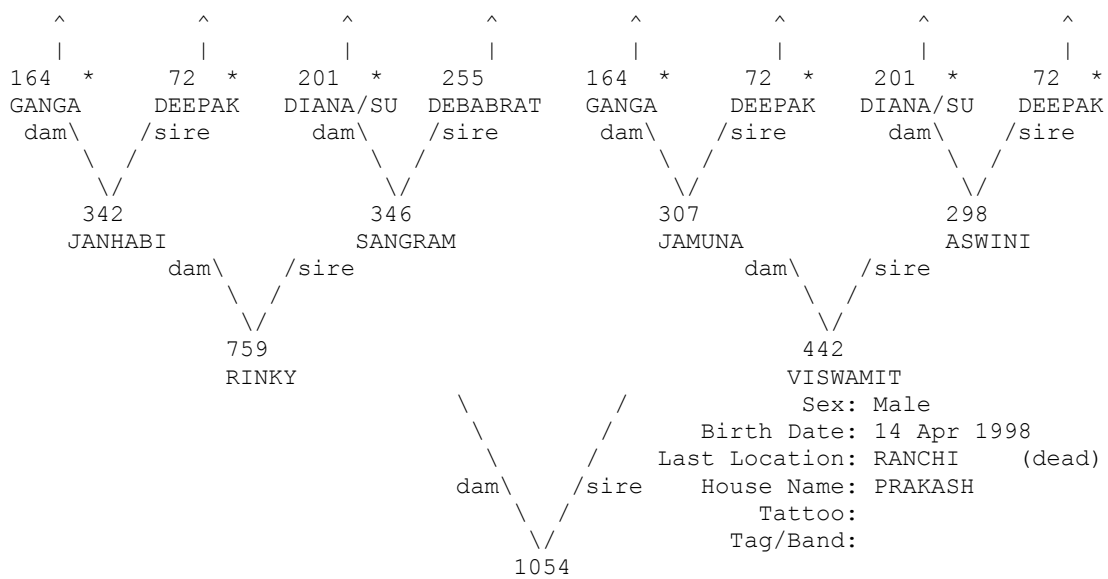

* Appear more than once...
 ^ Pedigree continues beyond top of page...

=====
 Taxon Name: PANTHERA TIGRIS Studbook Number: 1055
 =====

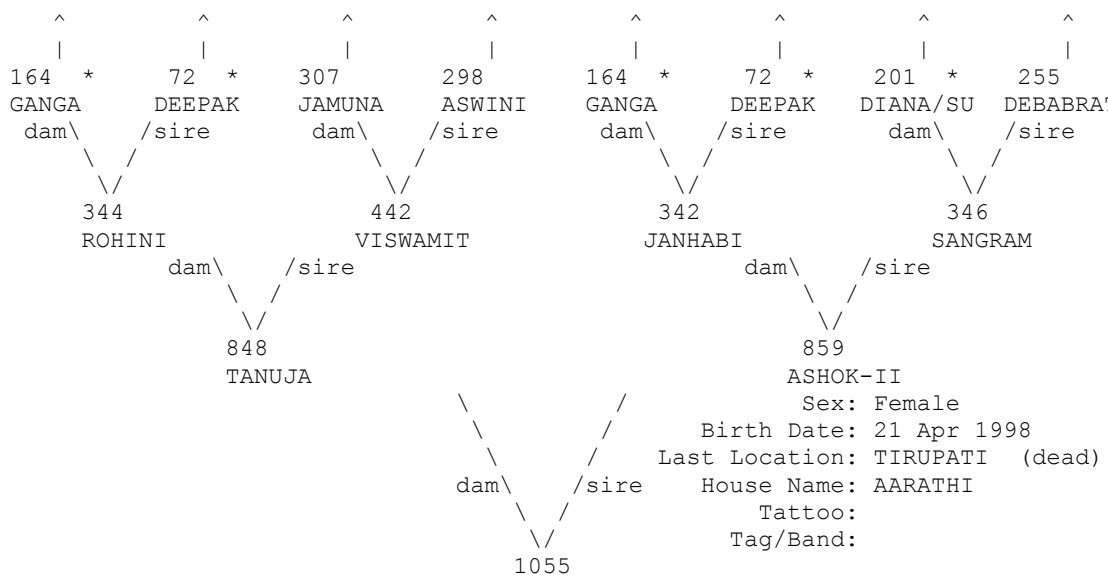

* Appear more than once...
 ^ Pedigree continues beyond top of page...

=====
 Taxon Name: PANTHERA TIGRIS Studbook Number: 1056
 =====

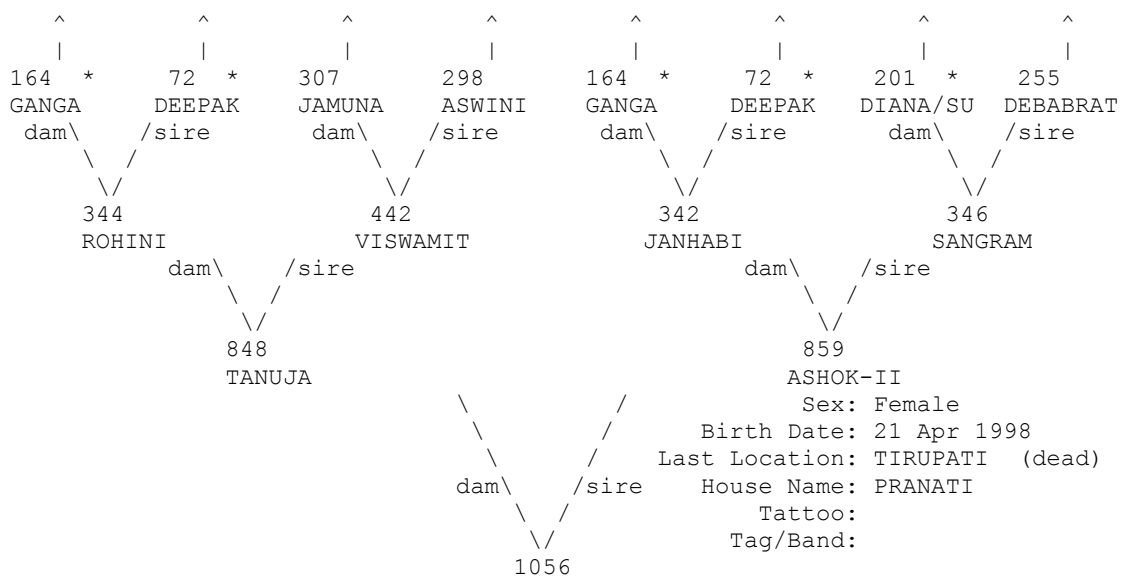

* Appear more than once...
 ^ Pedigree continues beyond top of page...

=====
 Taxon Name: PANTHERA TIGRIS Studbook Number: 1057
 =====

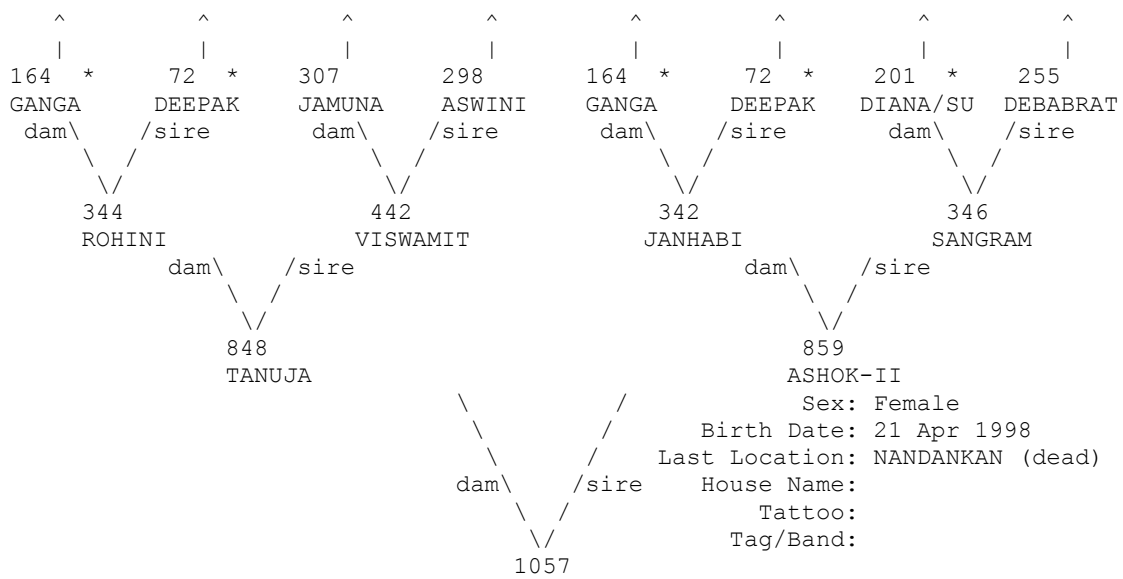

* Appear more than once...
 ^ Pedigree continues beyond top of page...

=====
 Taxon Name: PANTHERA TIGRIS Studbook Number: 1058
 =====

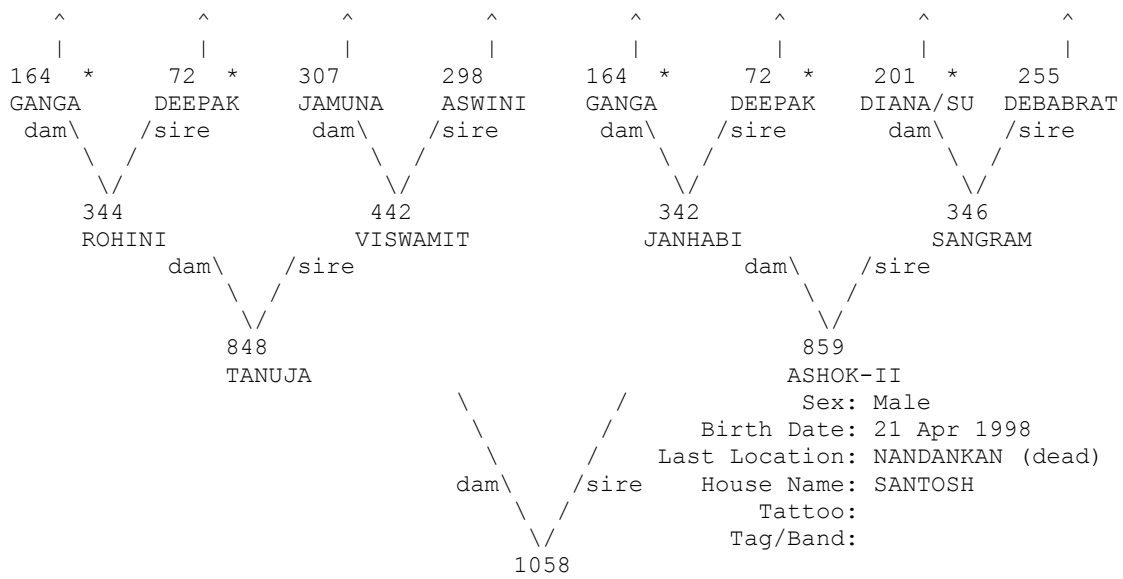

* Appear more than once...
 ^ Pedigree continues beyond top of page...

=====
 Taxon Name: PANTHERA TIGRIS Studbook Number: 1059
 =====

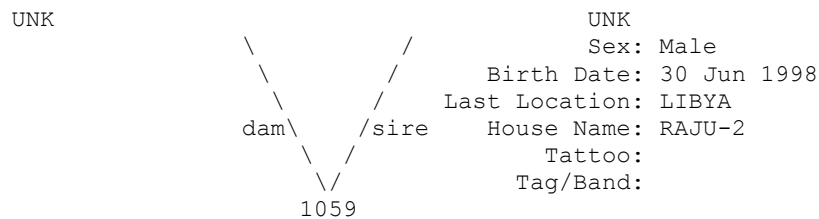

=====
 Taxon Name: PANTHERA TIGRIS Studbook Number: 1060
 =====

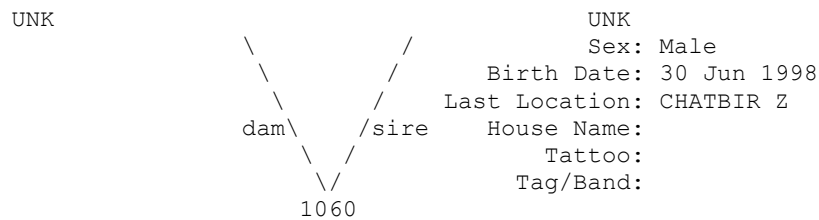

=====
 Taxon Name: PANTHERA TIGRIS Studbook Number: 1061
 =====

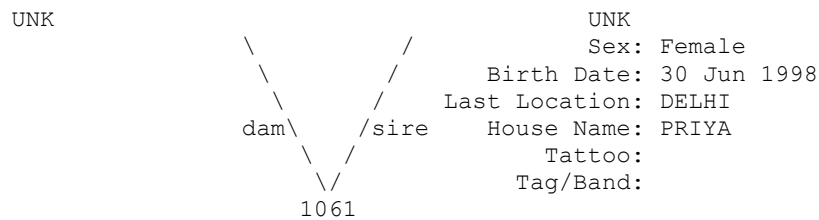

=====
 Taxon Name: PANTHERA TIGRIS Studbook Number: 1062
 =====

UNK

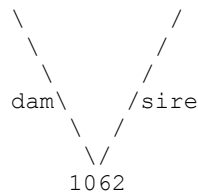

UNK
 Sex: Female
 Birth Date: 30 Jun 1998
 Last Location: CHATBIR Z
 House Name:
 Tattoo:
 Tag/Band:

=====
 Taxon Name: PANTHERA TIGRIS Studbook Number: 1063
 =====

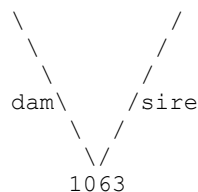
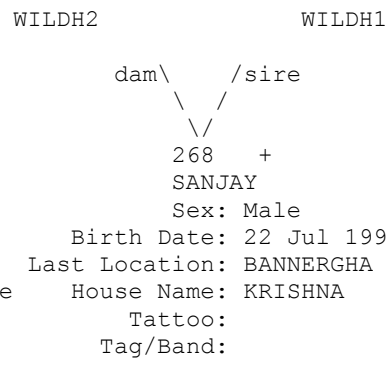
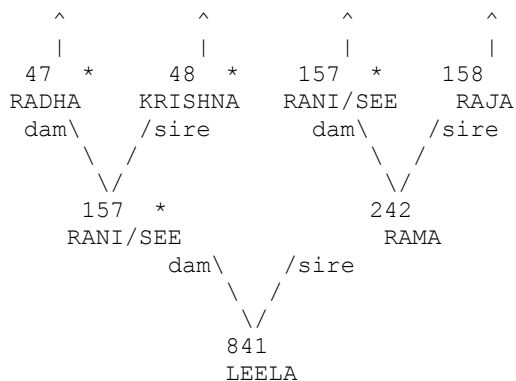

+ Wild-caught... * Appear more than once...
 ^ Pedigree continues beyond top of page...

=====
 Taxon Name: PANTHERA TIGRIS Studbook Number: 1064
 =====

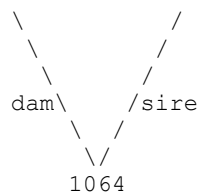
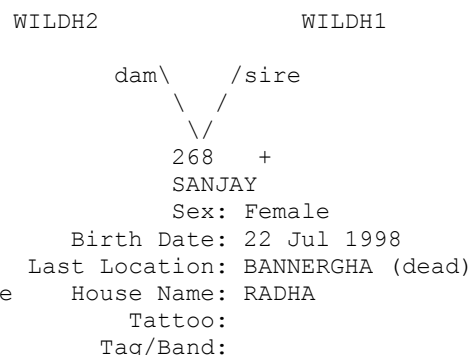
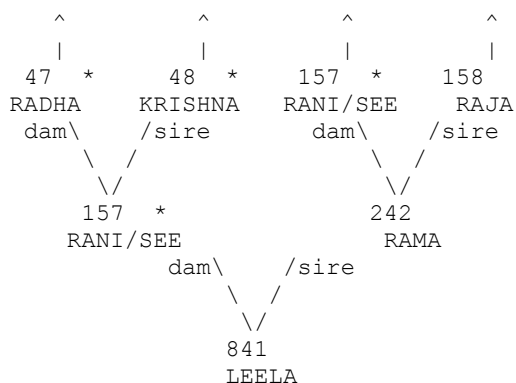

+ Wild-caught... * Appear more than once...
 ^ Pedigree continues beyond top of page...

=====
 Taxon Name: PANTHERA TIGRIS Studbook Number: 1067
 =====

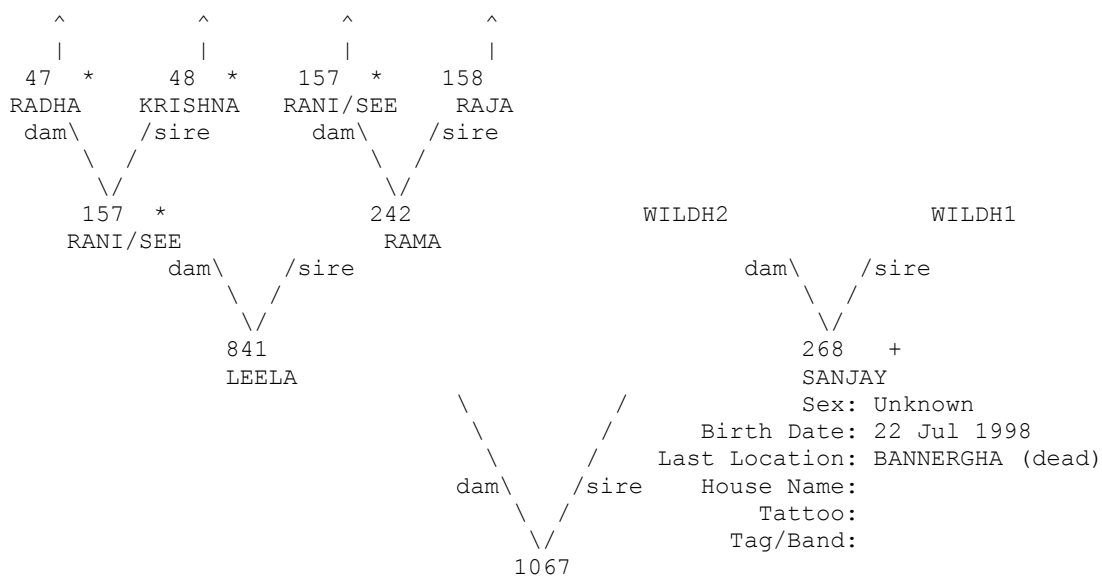

+ Wild-caught... * Appear more than once...
 ^ Pedigree continues beyond top of page...

=====
 Taxon Name: PANTHERA TIGRIS Studbook Number: 1068
 =====

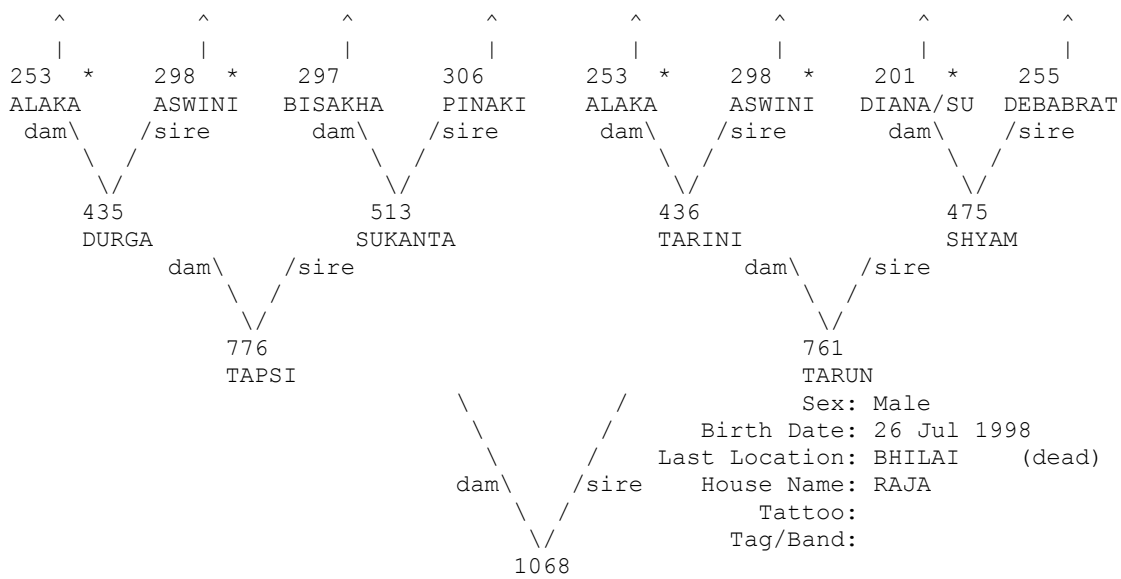

* Appear more than once...
 ^ Pedigree continues beyond top of page...

=====
 Taxon Name: PANTHERA TIGRIS Studbook Number: 1069
 =====

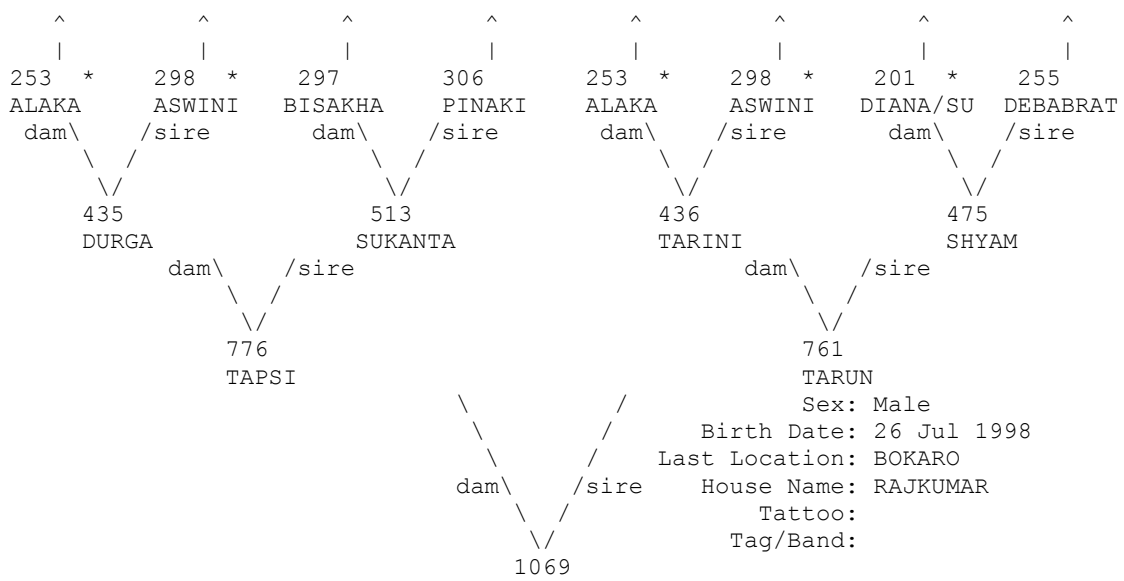

* Appear more than once...
 ^ Pedigree continues beyond top of page...

=====
 Taxon Name: PANTHERA TIGRIS Studbook Number: 1070
 =====

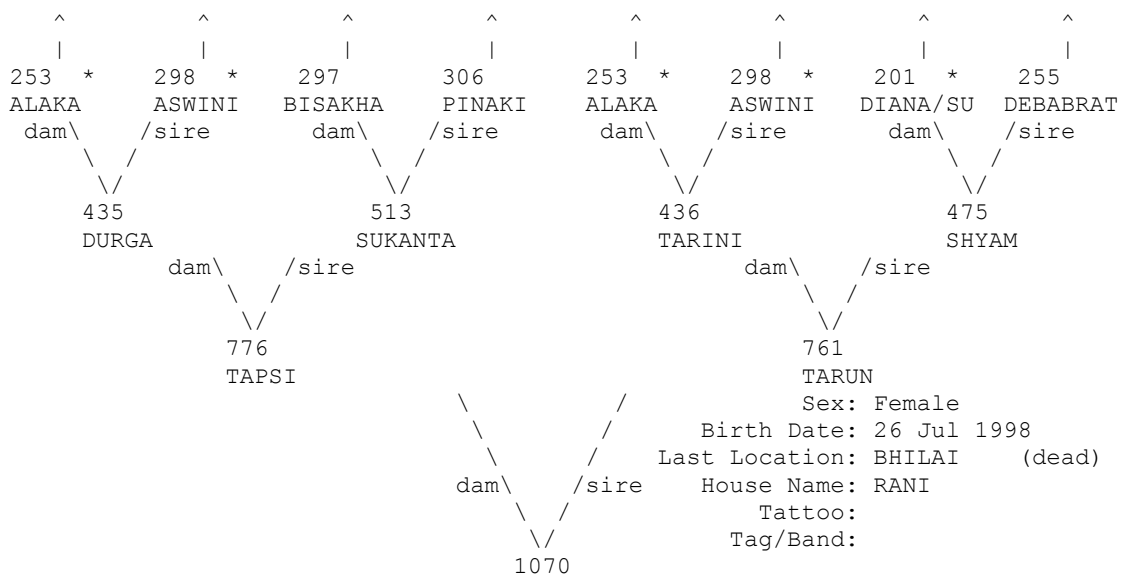

* Appear more than once...
 ^ Pedigree continues beyond top of page...

=====
 Taxon Name: PANTHERA TIGRIS Studbook Number: 1071
 =====

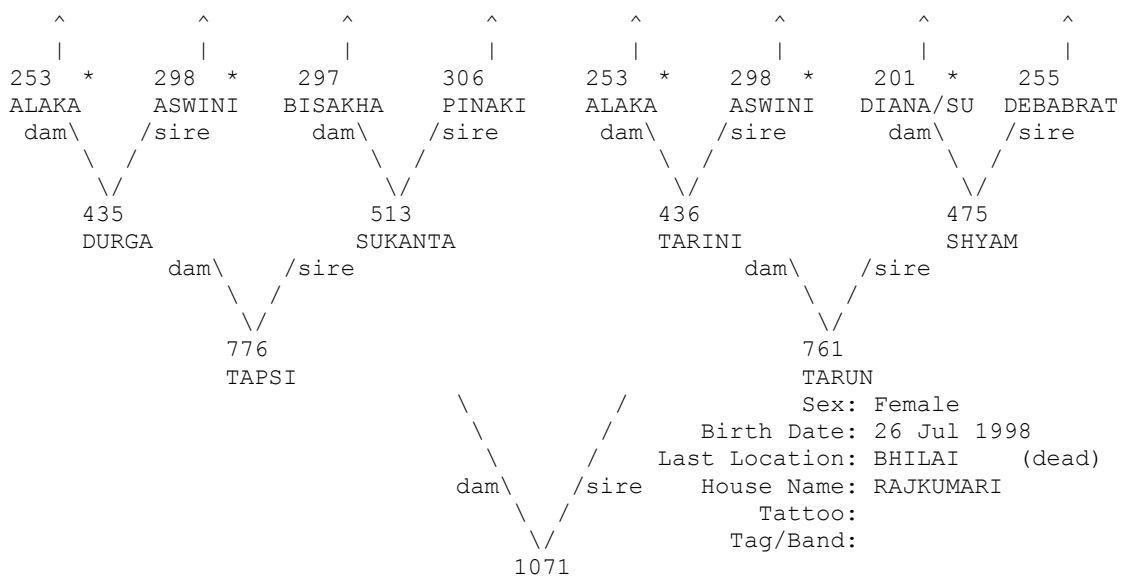

* Appear more than once...
 ^ Pedigree continues beyond top of page...

=====
 Taxon Name: PANTHERA TIGRIS Studbook Number: 1072
 =====

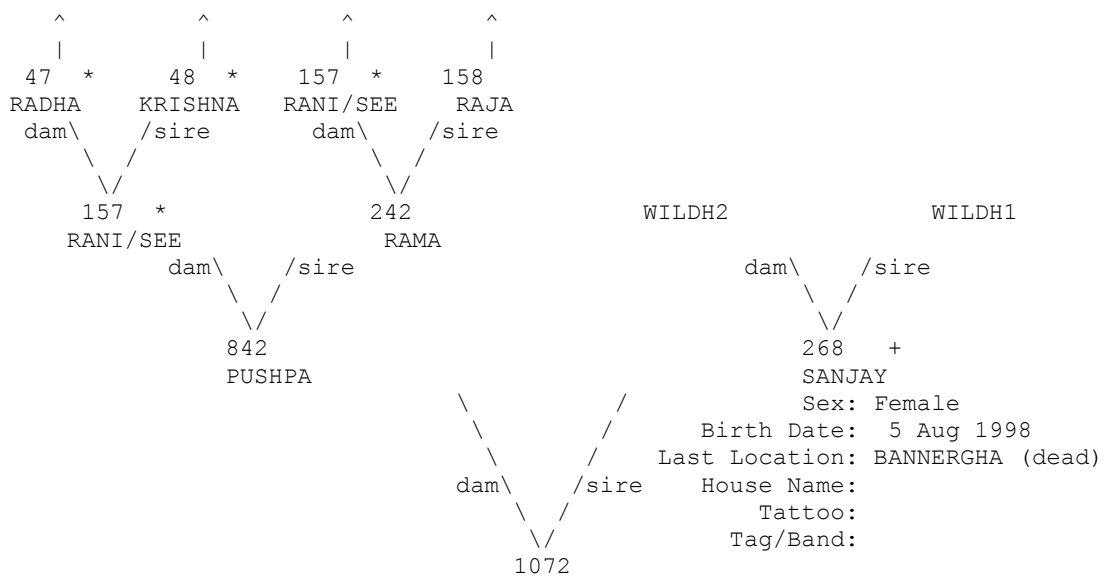

+ Wild-caught... * Appear more than once...
 ^ Pedigree continues beyond top of page...

=====
Taxon Name: PANTHERA TIGRIS

Studbook Number: 1073
=====

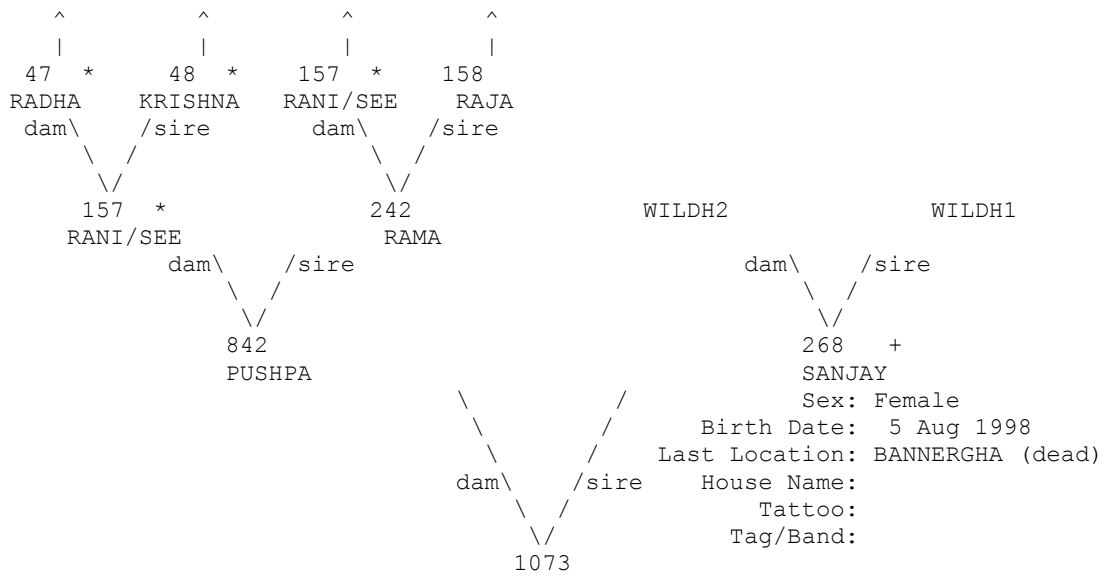

+ Wild-caught... * Appear more than once...

^ Pedigree continues beyond top of page...

=====
Taxon Name: PANTHERA TIGRIS

Studbook Number: 1074
=====

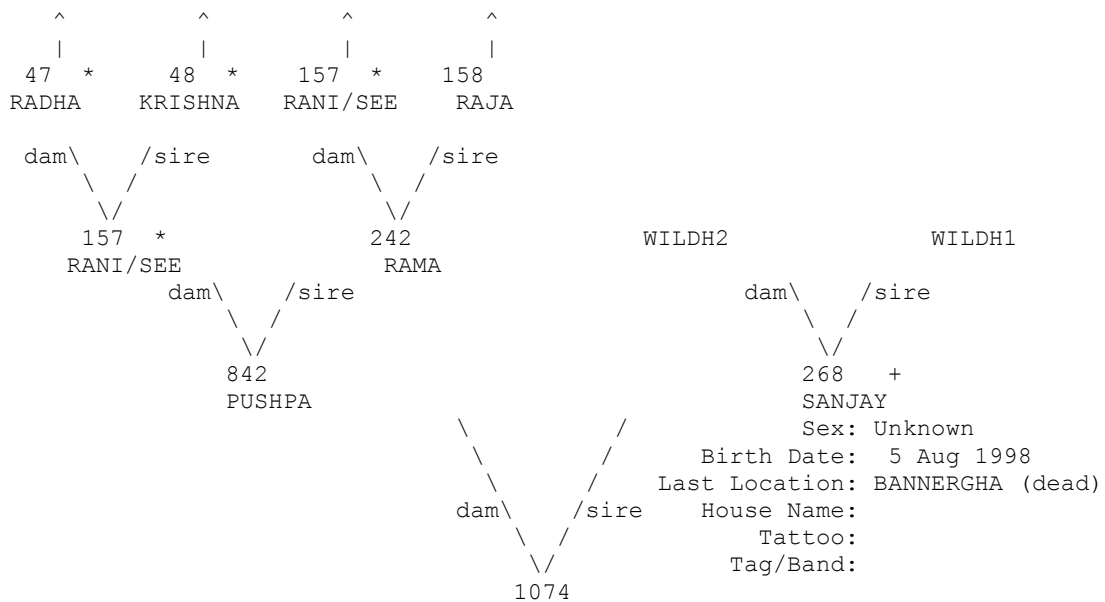

+ Wild-caught... * Appear more than once...

^ Pedigree continues beyond top of page...

=====
 Taxon Name: PANTHERA TIGRIS Studbook Number: 1080
 =====

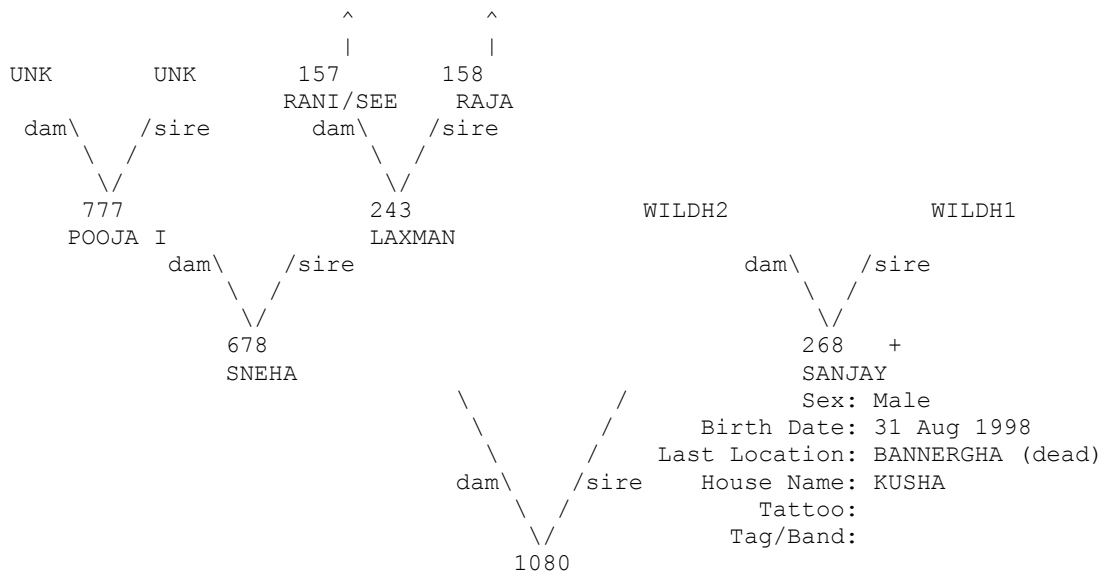

+ Wild-caught... * Appear more than once...
 ^ Pedigree continues beyond top of page...

=====
 Taxon Name: PANTHERA TIGRIS Studbook Number: 1081
 =====

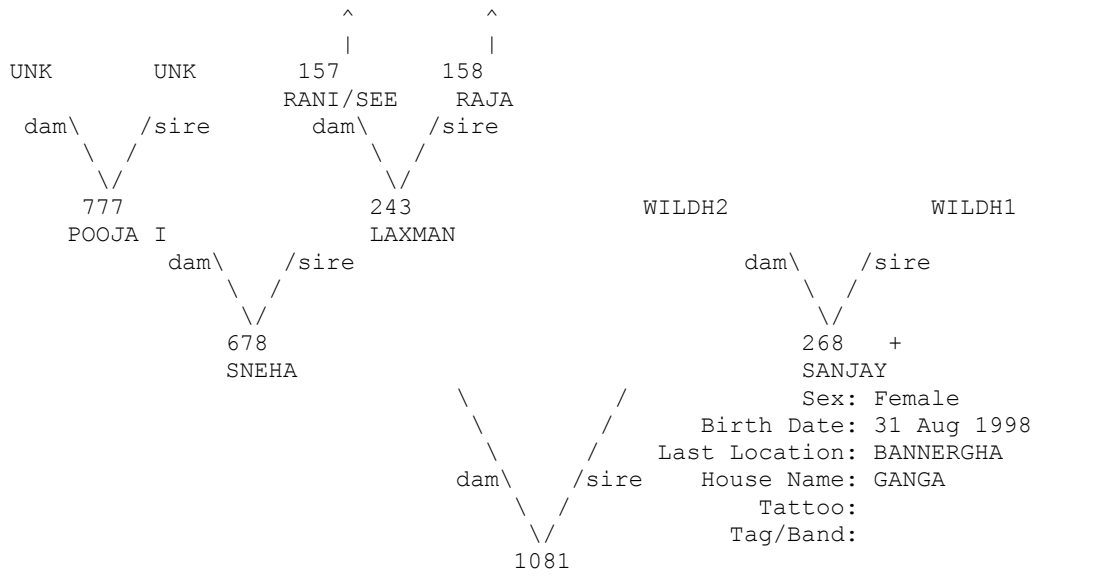

+ Wild-caught... * Appear more than once...
 ^ Pedigree continues beyond top of page...

=====
 Taxon Name: PANTHERA TIGRIS Studbook Number: 1082
 =====

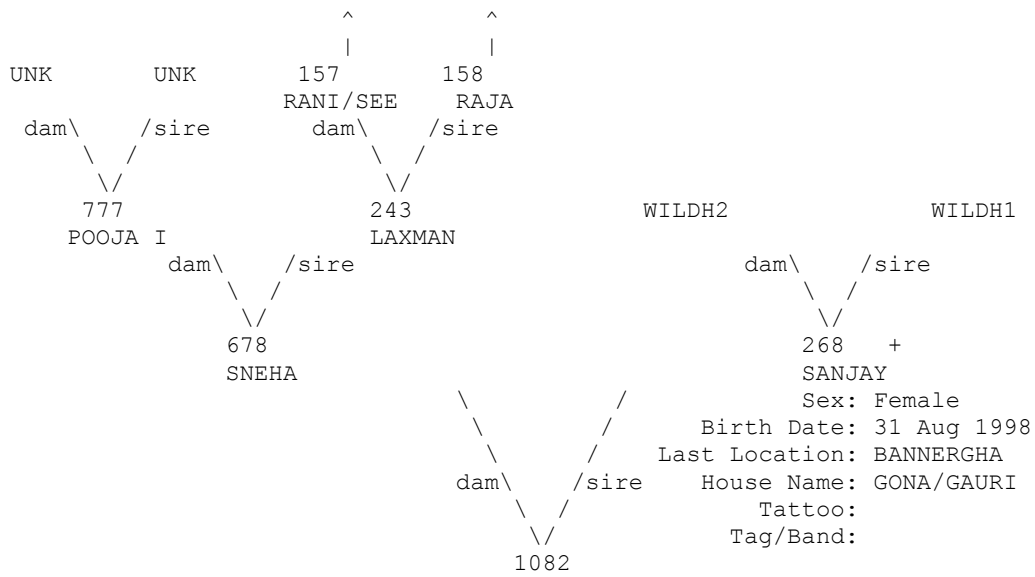

+ Wild-caught... * Appear more than once...
 ^ Pedigree continues beyond top of page...

=====
 Taxon Name: PANTHERA TIGRIS Studbook Number: 1083
 =====

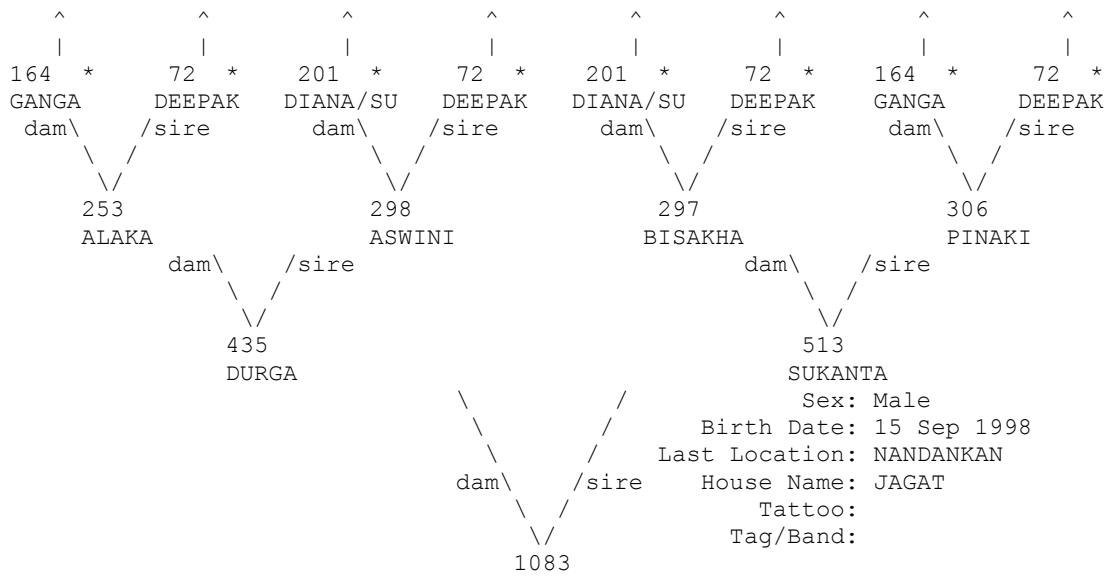

* Appear more than once...
 ^ Pedigree continues beyond top of page...

=====
 Taxon Name: PANTHERA TIGRIS Studbook Number: 1084
 =====

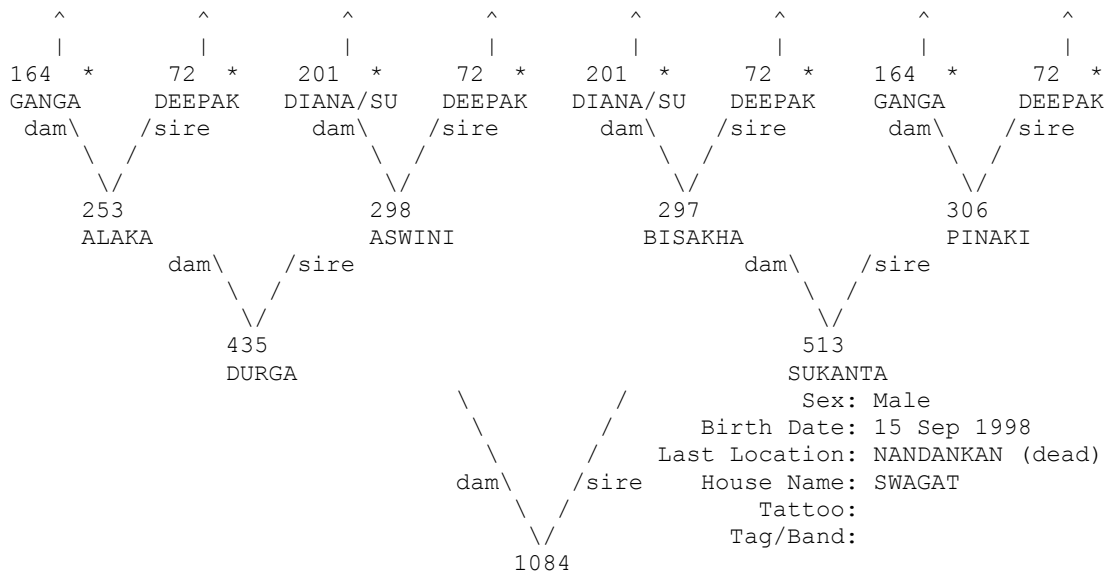

* Appear more than once...
 ^ Pedigree continues beyond top of page...

=====
 Taxon Name: PANTHERA TIGRIS Studbook Number: 1087
 =====

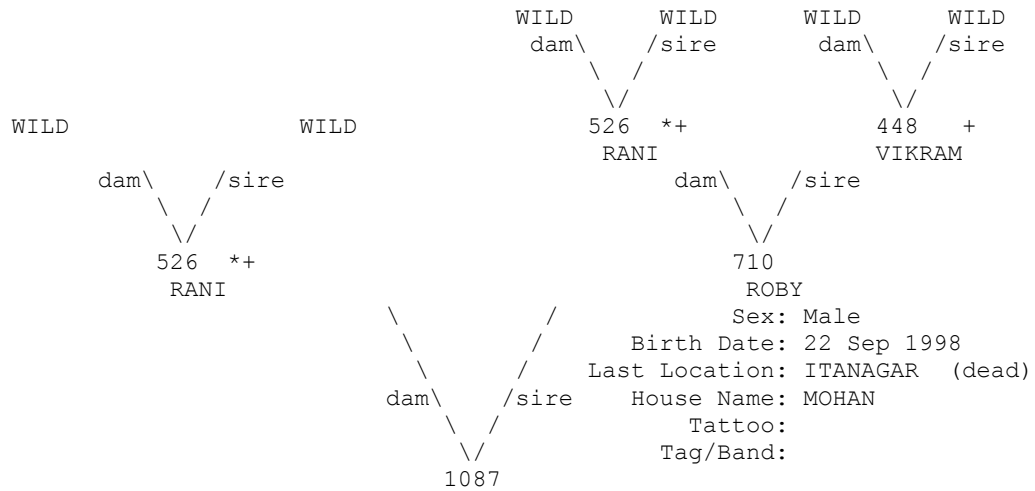

+ Wild-caught... * Appear more than once...

=====

Taxon Name: PANTHERA TIGRIS Studbook Number: 1088

=====

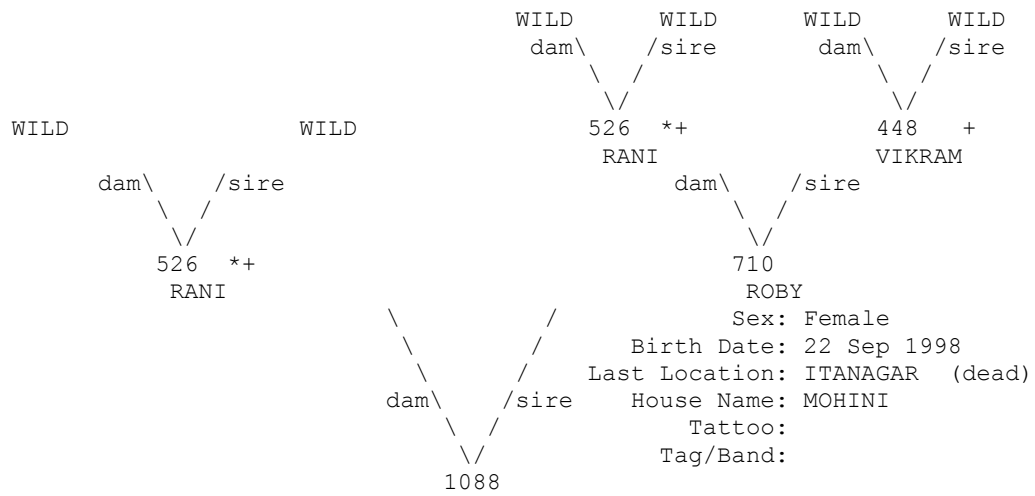

+ Wild-caught... * Appear more than once...

=====

Taxon Name: PANTHERA TIGRIS Studbook Number: 1090

=====

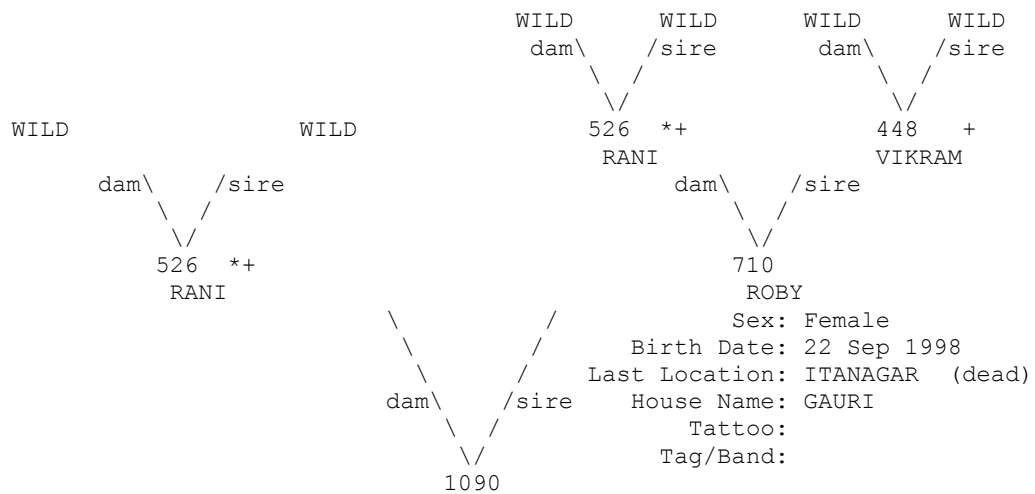

+ Wild-caught... * Appear more than once...

=====
 Taxon Name: PANTHERA TIGRIS Studbook Number: 1091
 =====

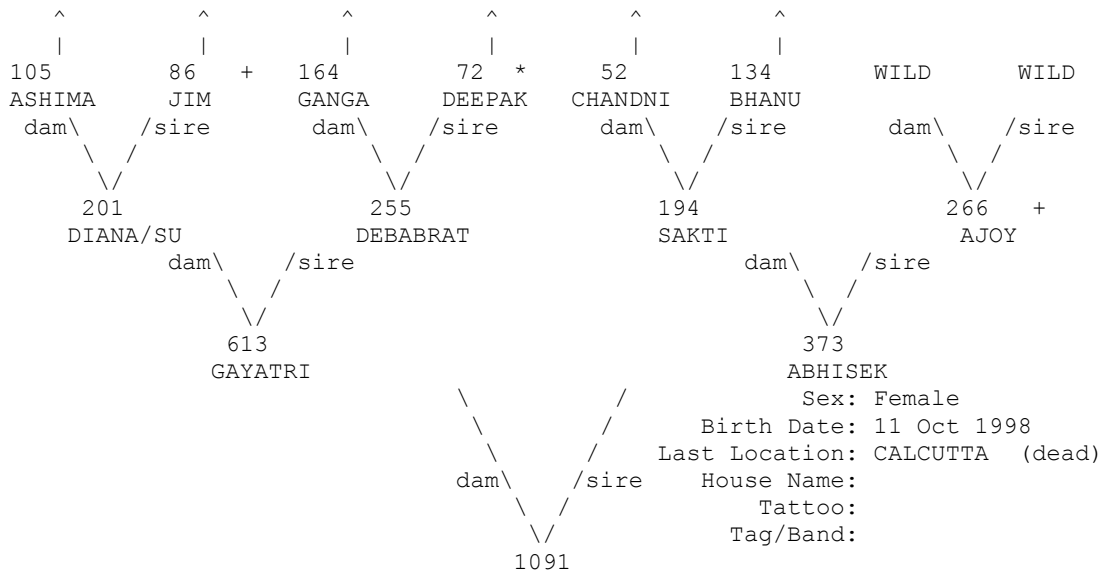

+ Wild-caught... * Appear more than once...
 ^ Pedigree continues beyond top of page...

=====
 Taxon Name: PANTHERA TIGRIS Studbook Number: 1092
 =====

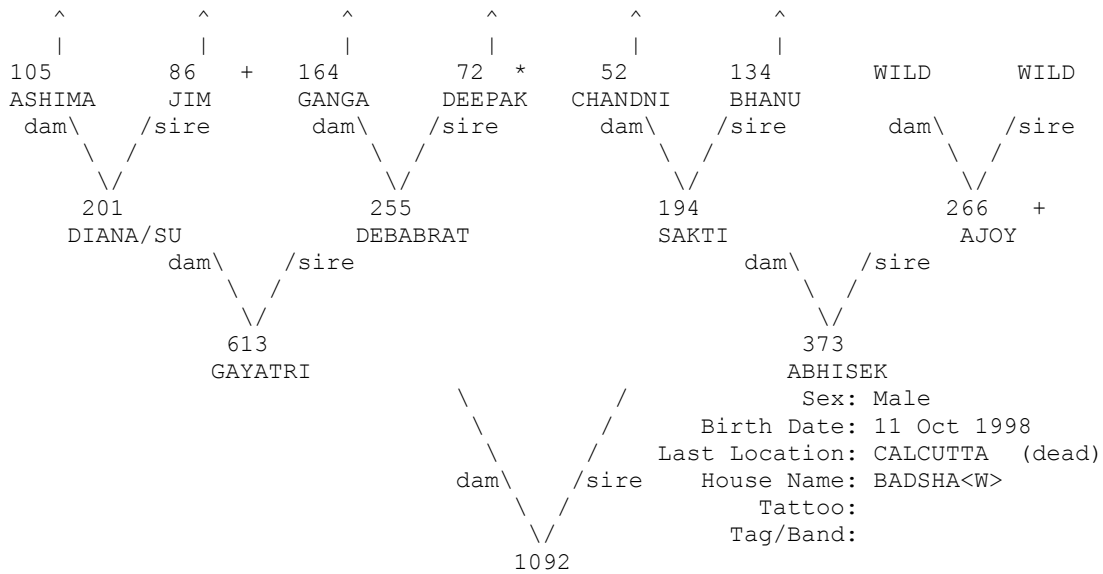

+ Wild-caught... * Appear more than once...
 ^ Pedigree continues beyond top of page...

=====
 Taxon Name: PANTHERA TIGRIS Studbook Number: 1093
 =====

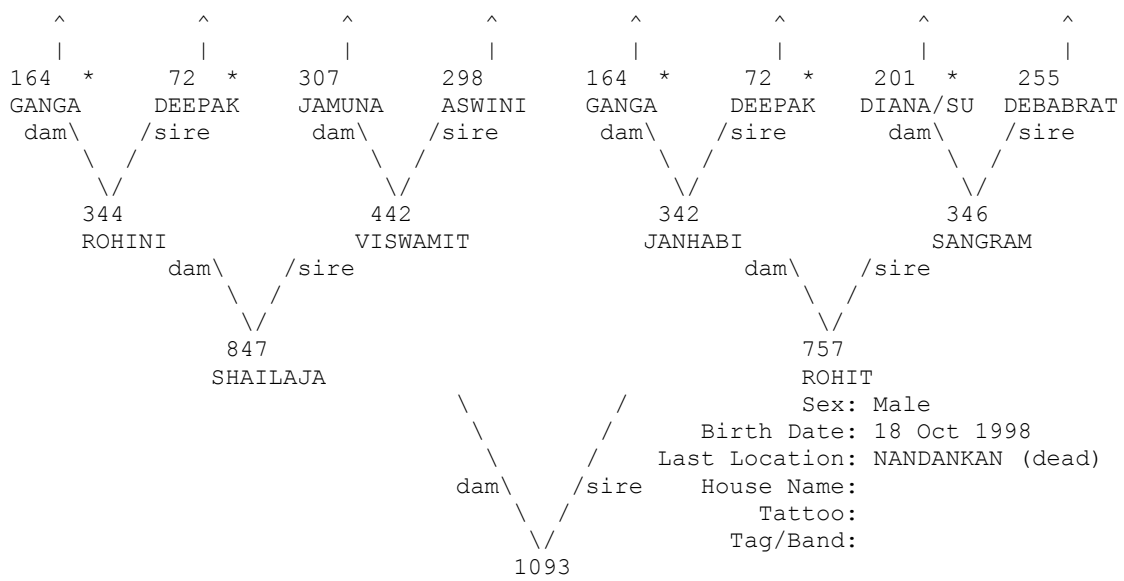

* Appear more than once...
 ^ Pedigree continues beyond top of page...

=====
 Taxon Name: PANTHERA TIGRIS Studbook Number: 1094
 =====

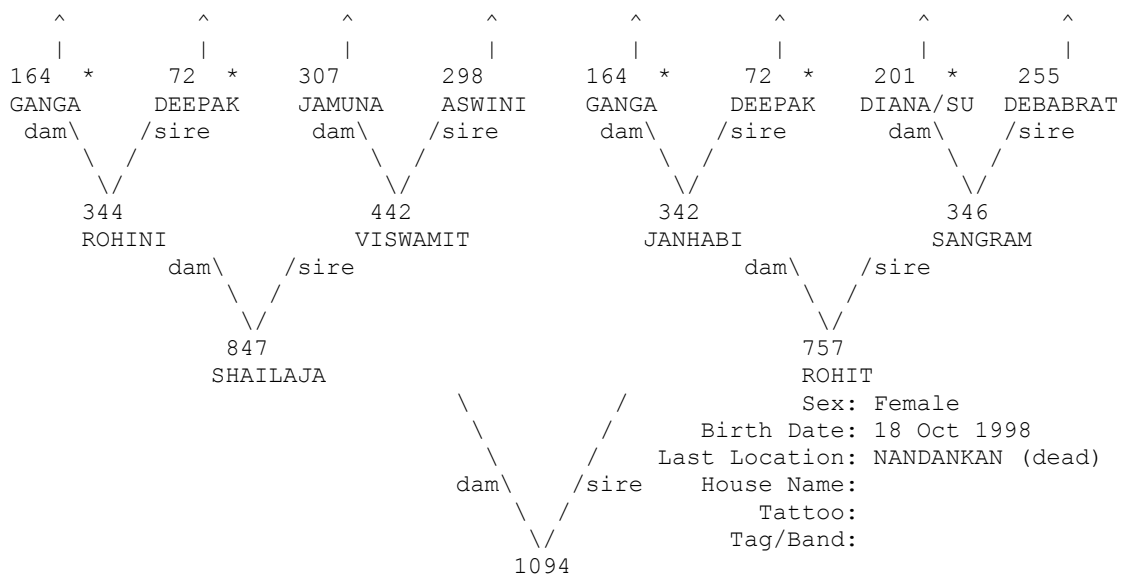

* Appear more than once...
 ^ Pedigree continues beyond top of page...

=====
 Taxon Name: PANTHERA TIGRIS Studbook Number: 1098
 =====

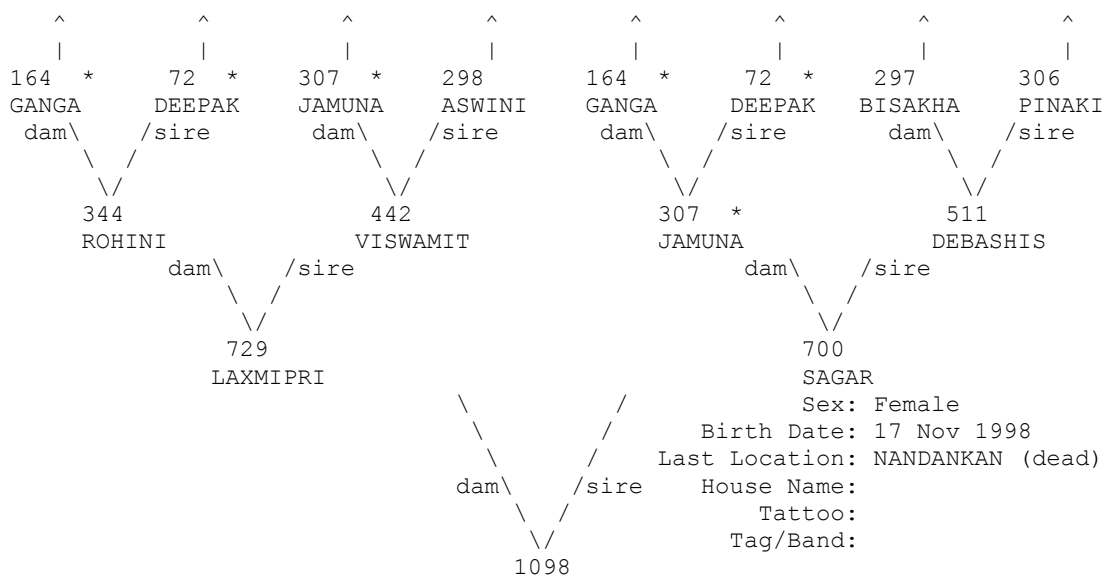

* Appear more than once...
 ^ Pedigree continues beyond top of page...

=====
 Taxon Name: PANTHERA TIGRIS Studbook Number: 1099
 =====

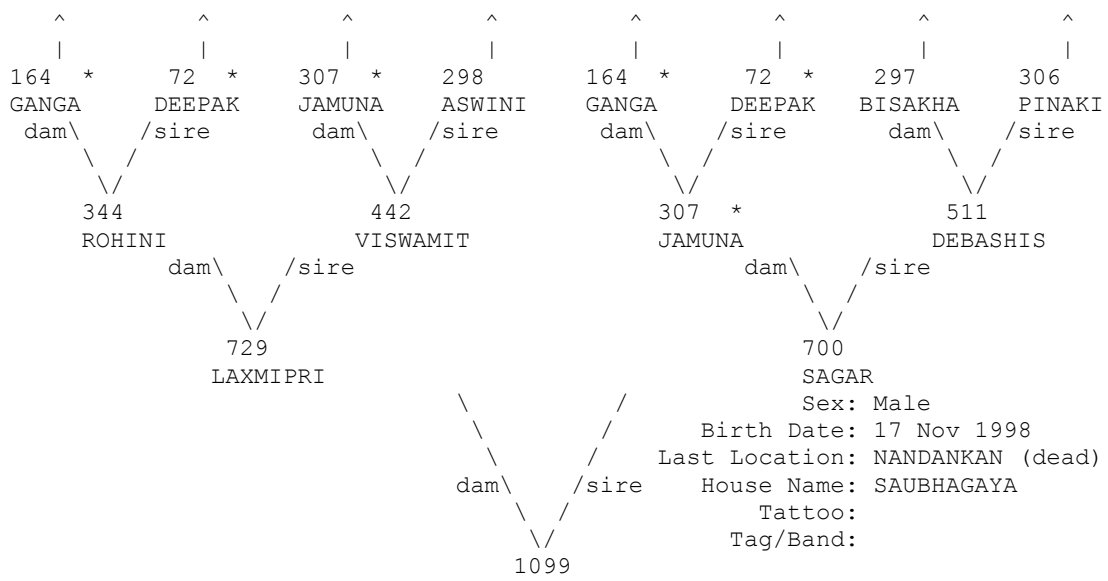

* Appear more than once...
 ^ Pedigree continues beyond top of page...

=====
 Taxon Name: PANTHERA TIGRIS Studbook Number: 1100
 =====

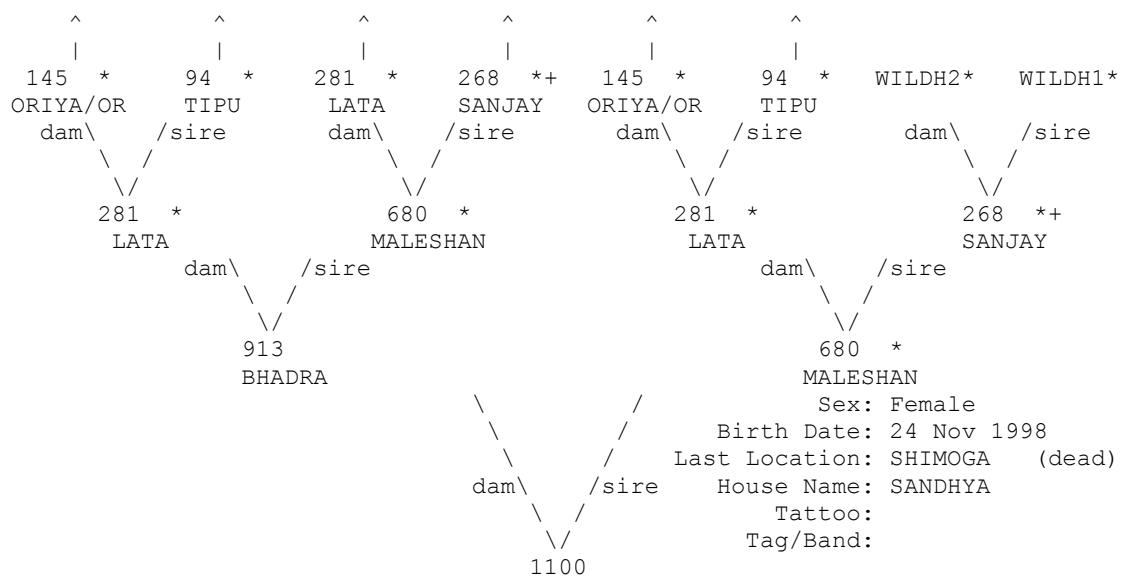

+ Wild-caught... * Appear more than once...
 ^ Pedigree continues beyond top of page...

=====
 Taxon Name: PANTHERA TIGRIS Studbook Number: 1101
 =====

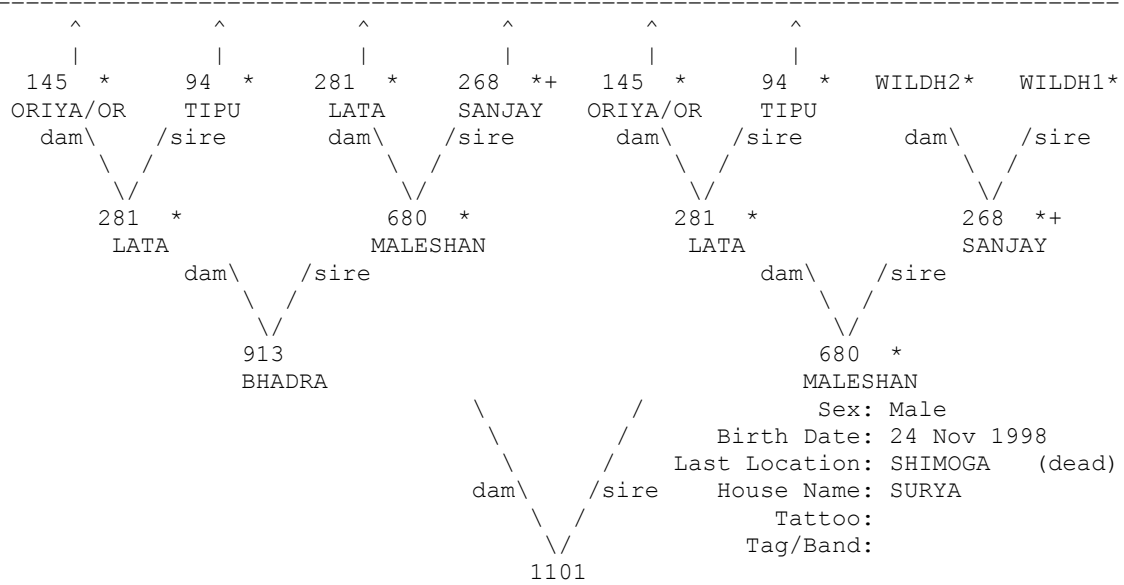

+ Wild-caught... * Appear more than once...
 ^ Pedigree continues beyond top of page...

=====
 Taxon Name: PANTHERA TIGRIS Studbook Number: 1102
 =====

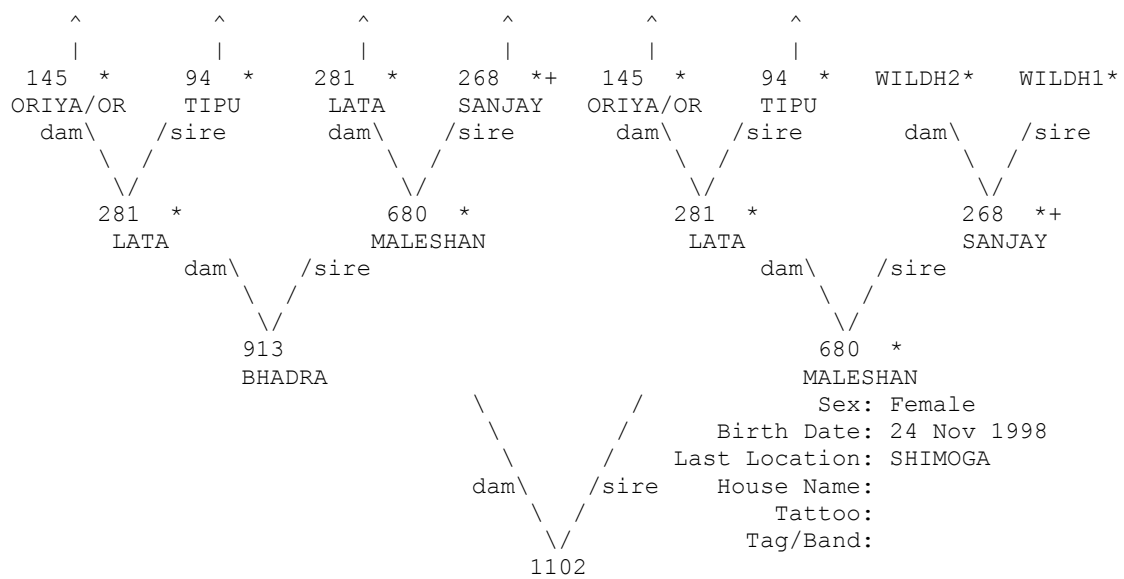

+ Wild-caught... * Appear more than once...
 ^ Pedigree continues beyond top of page...

=====
 Taxon Name: PANTHERA TIGRIS Studbook Number: 1103
 =====

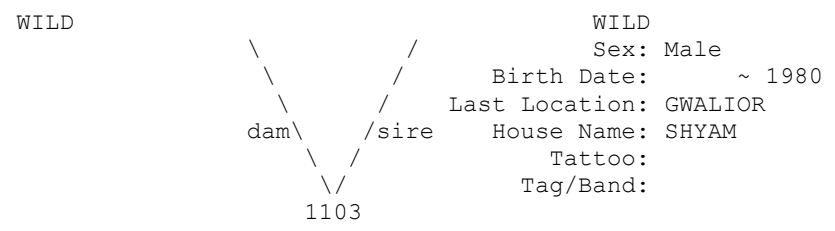

=====
 Taxon Name: PANTHERA TIGRIS Studbook Number: 1104
 =====

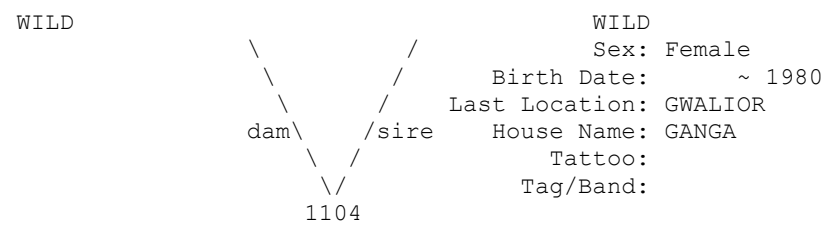

=====
 Taxon Name: PANTHERA TIGRIS Studbook Number: 1105
 =====

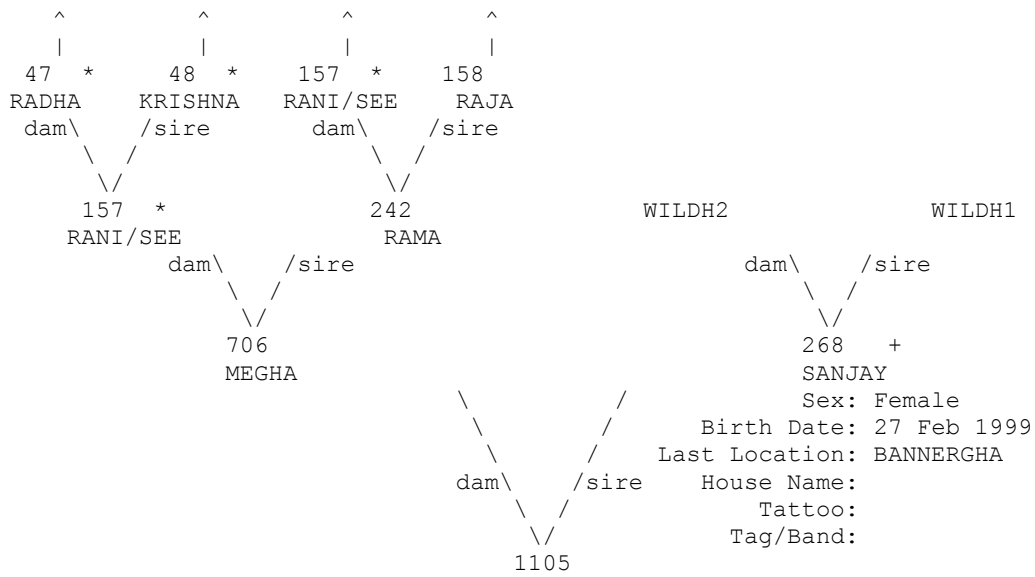

+ Wild-caught... * Appear more than once...
 ^ Pedigree continues beyond top of page...

=====
 Taxon Name: PANTHERA TIGRIS Studbook Number: 1106
 =====

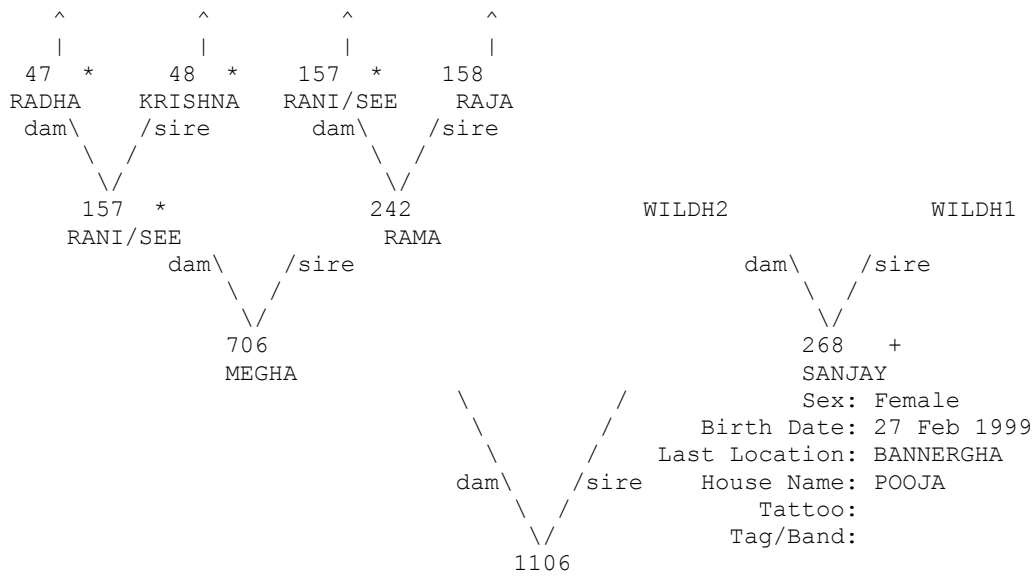

+ Wild-caught... * Appear more than once...
 ^ Pedigree continues beyond top of page...

=====
 Taxon Name: PANTHERA TIGRIS Studbook Number: 1107
 =====

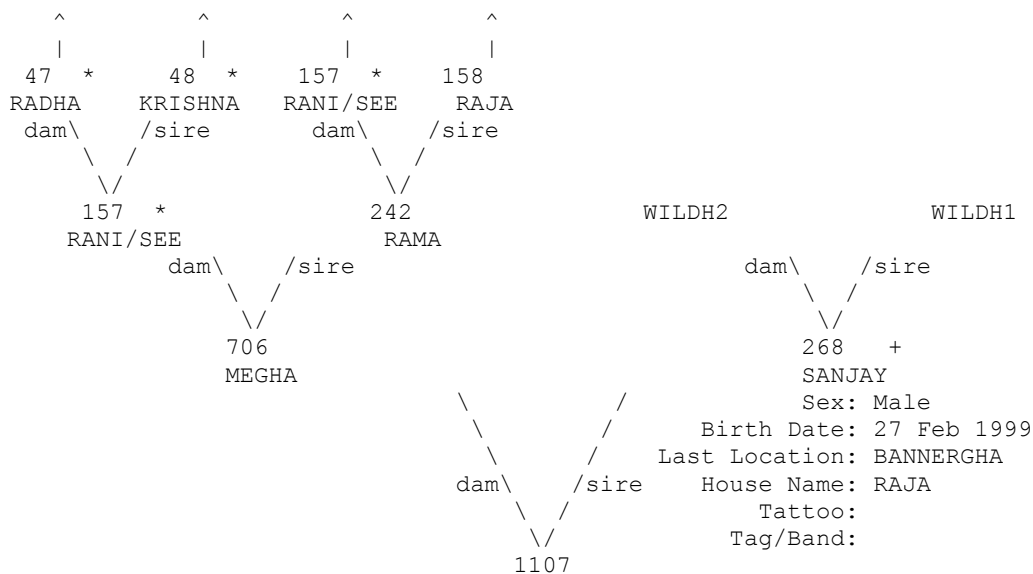

+ Wild-caught... * Appear more than once...
 ^ Pedigree continues beyond top of page...

=====
 Taxon Name: PANTHERA TIGRIS Studbook Number: 1108
 =====

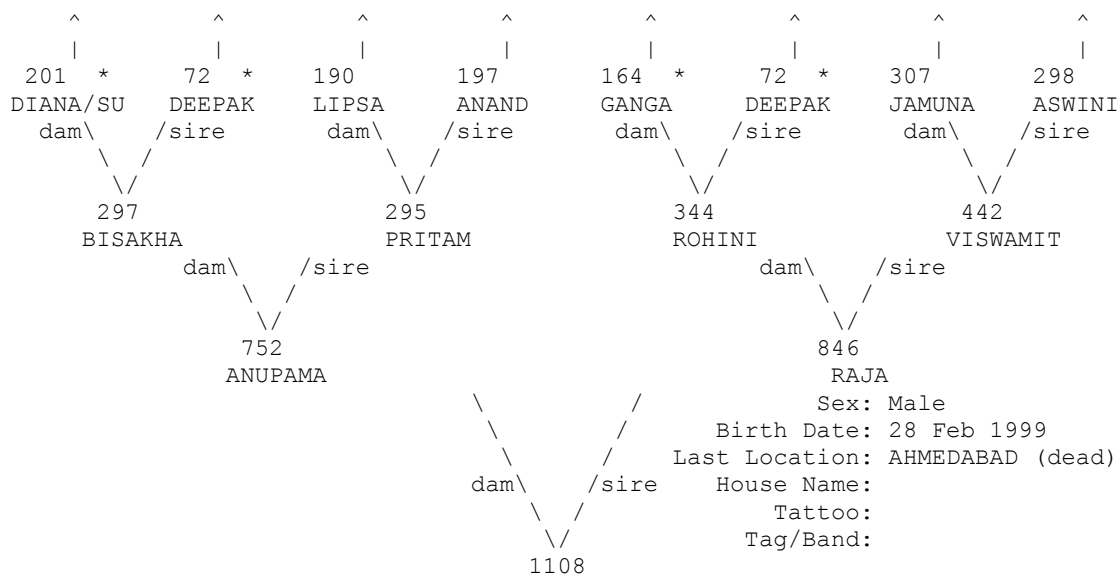

* Appear more than once...
 ^ Pedigree continues beyond top of page...

=====
 Taxon Name: PANTHERA TIGRIS Studbook Number: 1109
 =====

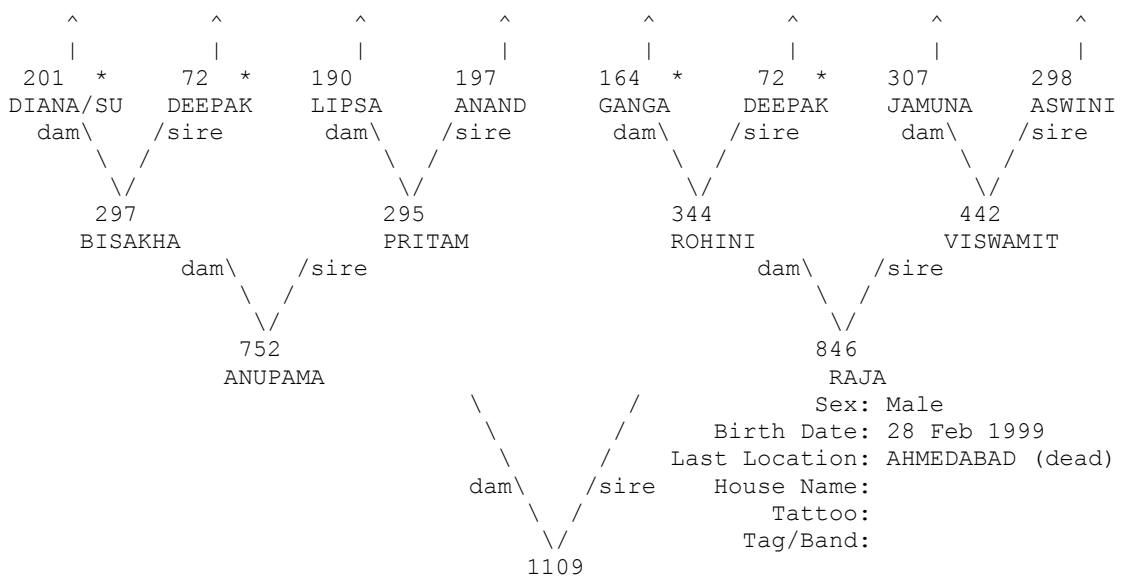

* Appear more than once...
 ^ Pedigree continues beyond top of page...

=====
 Taxon Name: PANTHERA TIGRIS Studbook Number: 1110
 =====

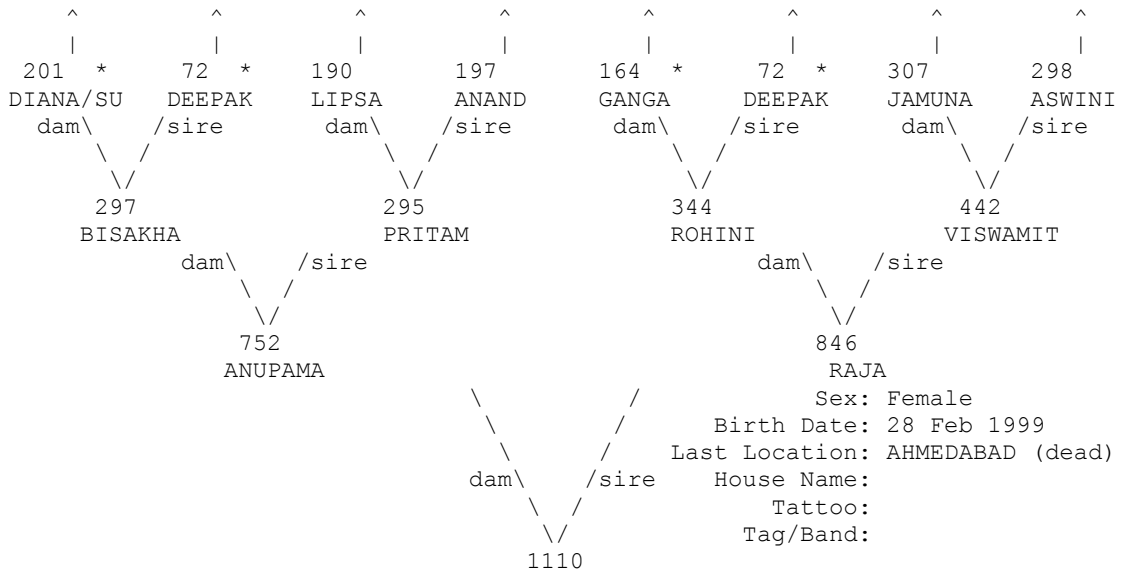

* Appear more than once...
 ^ Pedigree continues beyond top of page...

=====
 Taxon Name: PANTHERA TIGRIS Studbook Number: 1111
 =====

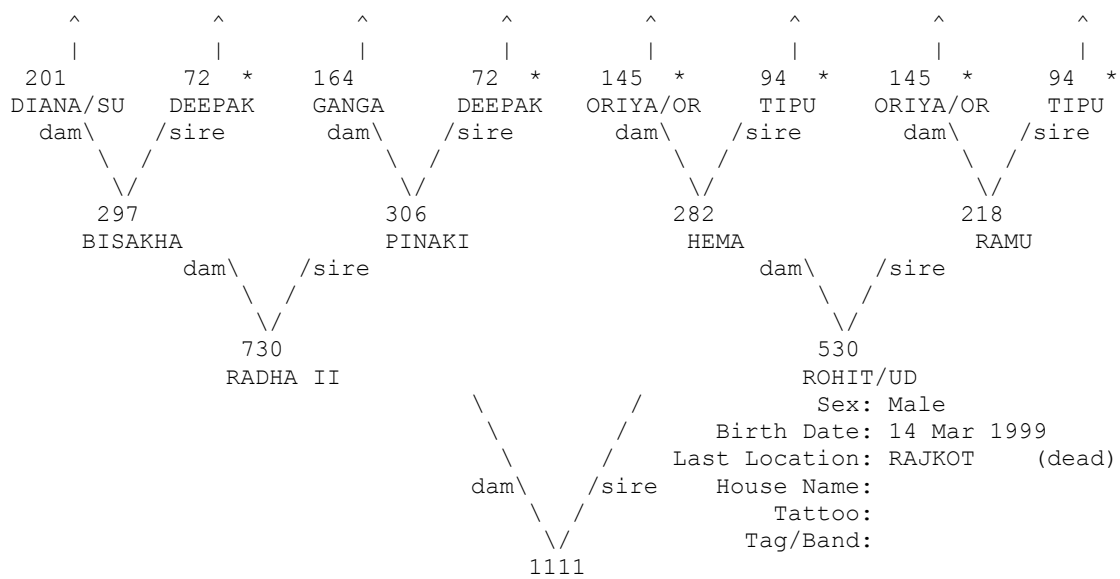

* Appear more than once...
 ^ Pedigree continues beyond top of page...

=====
 Taxon Name: PANTHERA TIGRIS Studbook Number: 1112
 =====

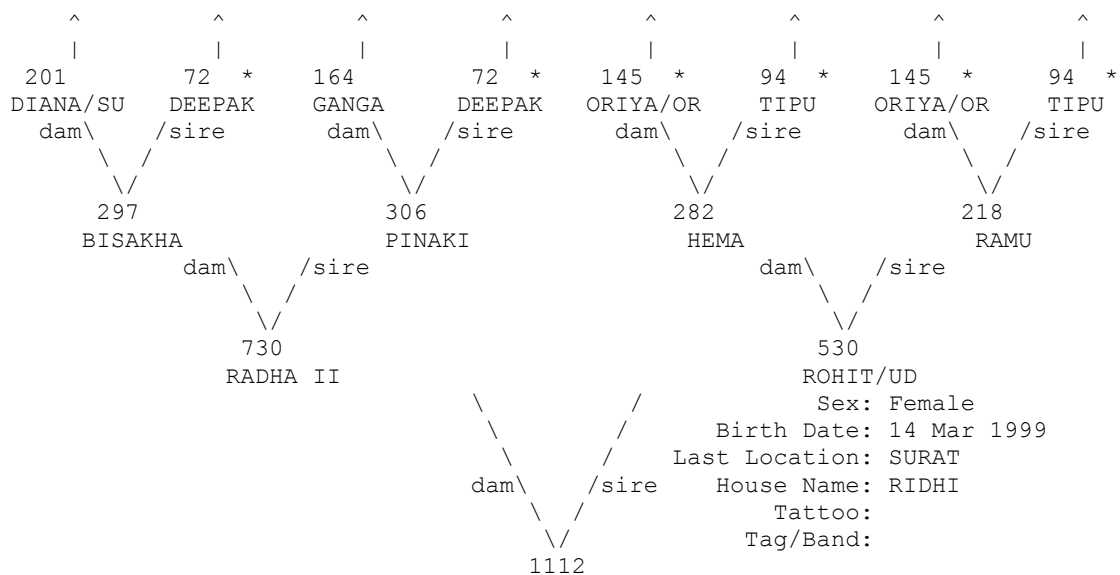

* Appear more than once...
 ^ Pedigree continues beyond top of page...

=====
 Taxon Name: PANTHERA TIGRIS Studbook Number: 1113
 =====

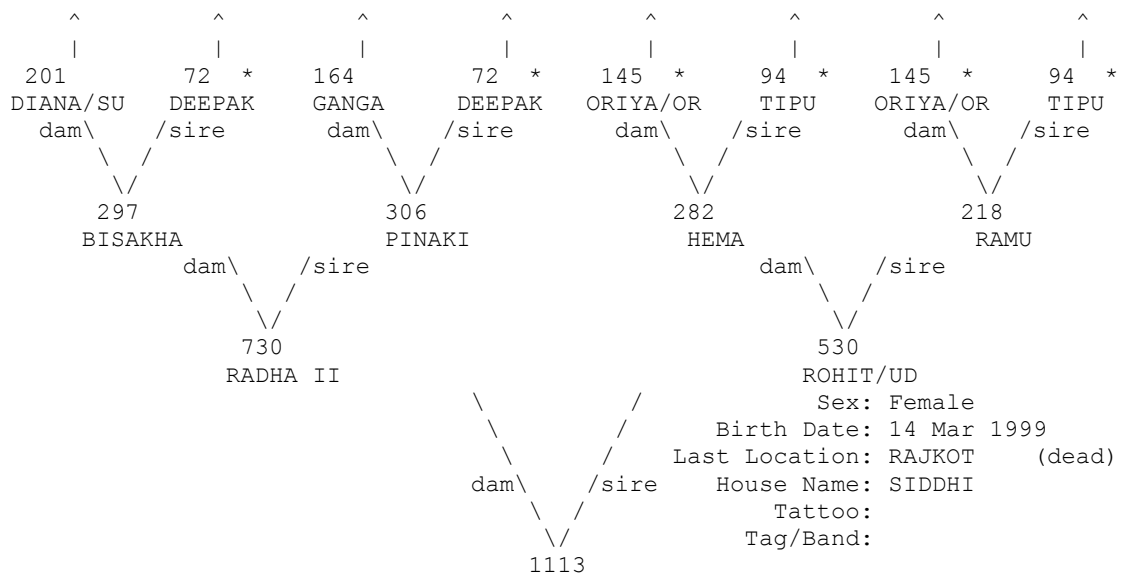

* Appear more than once...
 ^ Pedigree continues beyond top of page...

=====
 Taxon Name: PANTHERA TIGRIS Studbook Number: 1114
 =====

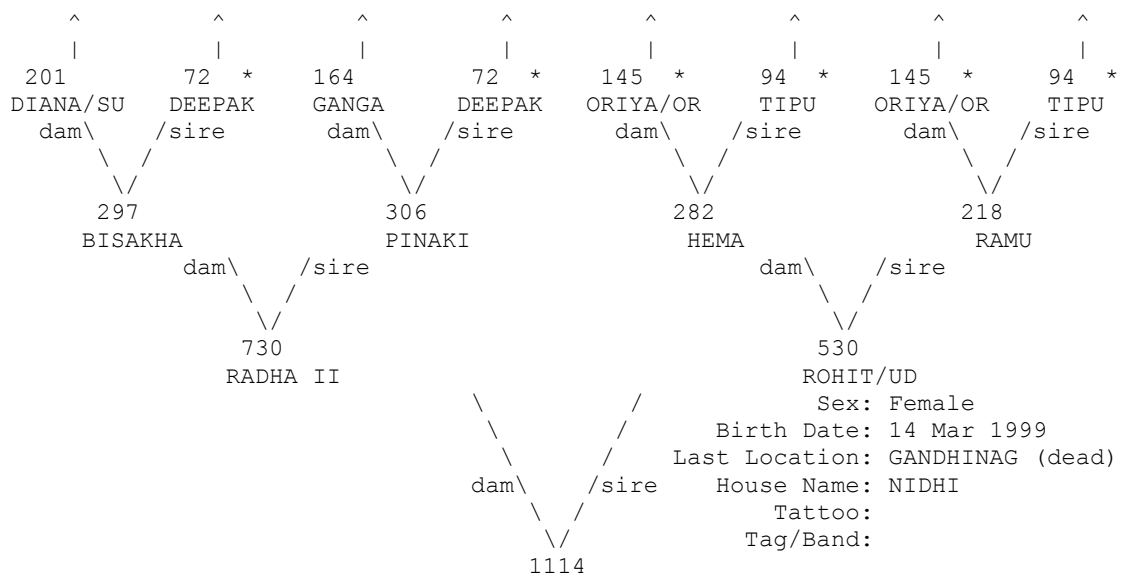

* Appear more than once...
 ^ Pedigree continues beyond top of page...

=====
 Taxon Name: PANTHERA TIGRIS Studbook Number: 1115
 =====

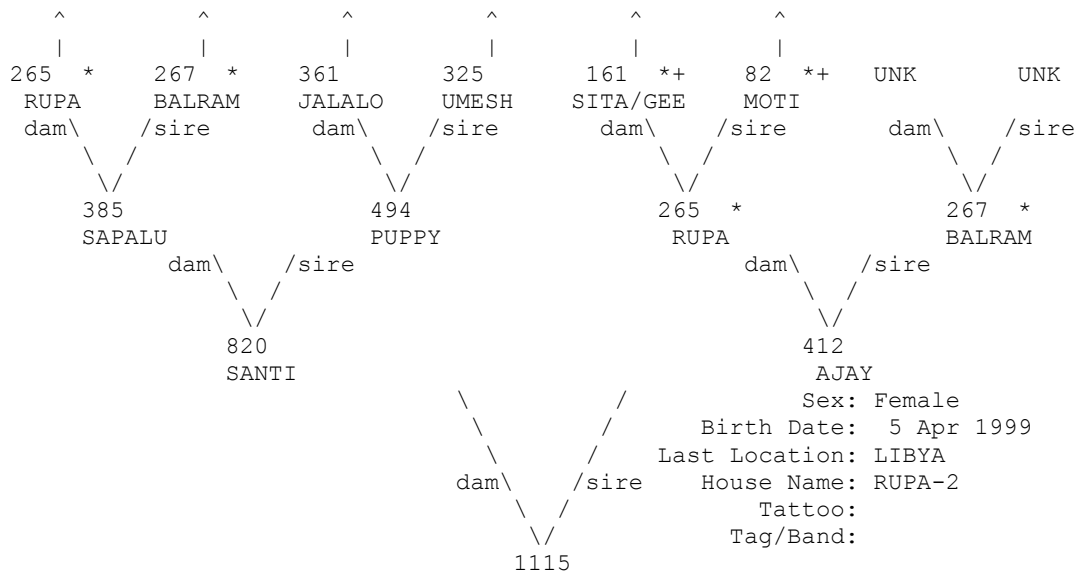

+ Wild-caught... * Appear more than once...
 ^ Pedigree continues beyond top of page...

=====
 Taxon Name: PANTHERA TIGRIS Studbook Number: 1116
 =====

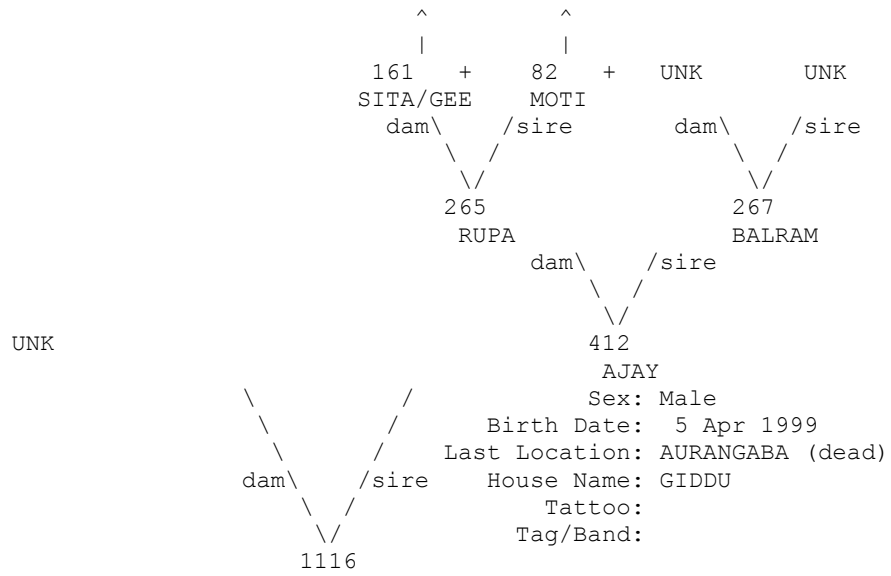

+ Wild-caught...
 ^ Pedigree continues beyond top of page...

=====
 Taxon Name: PANTHERA TIGRIS Studbook Number: 1117
 =====

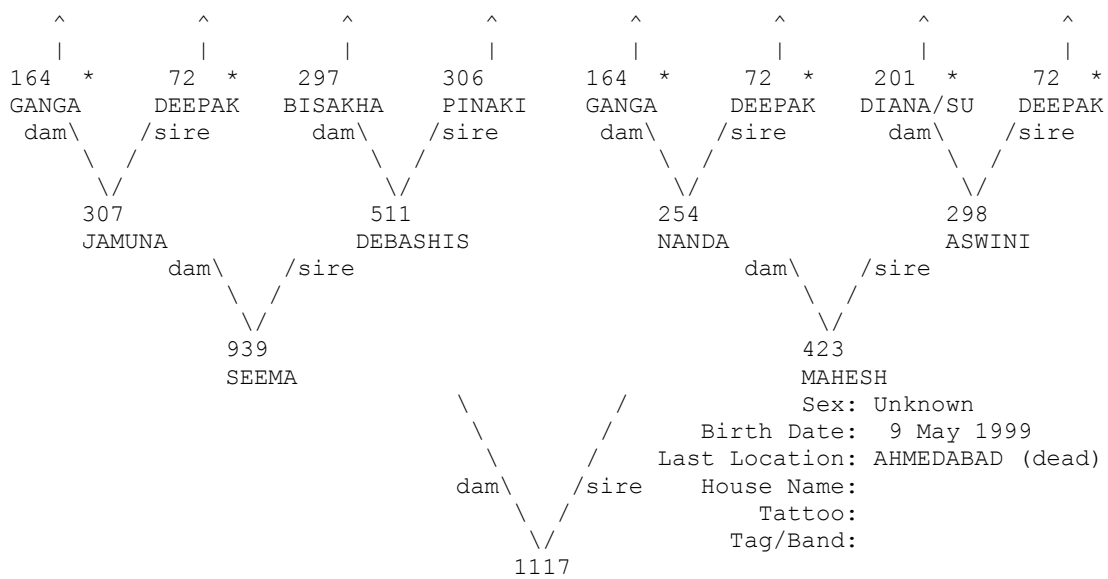

* Appear more than once...
 ^ Pedigree continues beyond top of page...

=====
 Taxon Name: PANTHERA TIGRIS Studbook Number: 1118
 =====

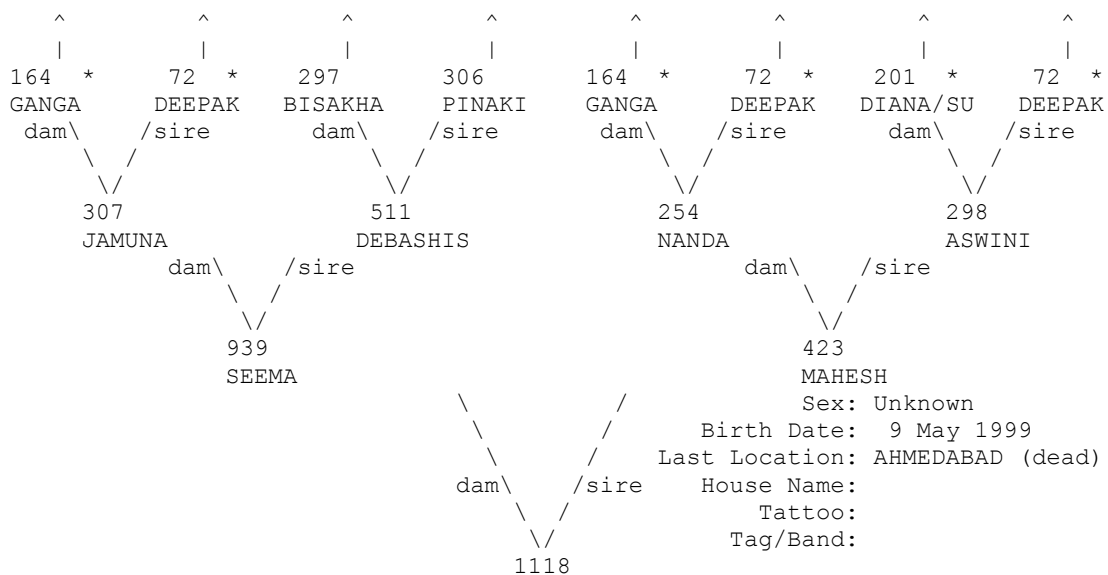

* Appear more than once...
 ^ Pedigree continues beyond top of page...

=====

Taxon Name: PANTHERA TIGRIS Studbook Number: 1119

=====

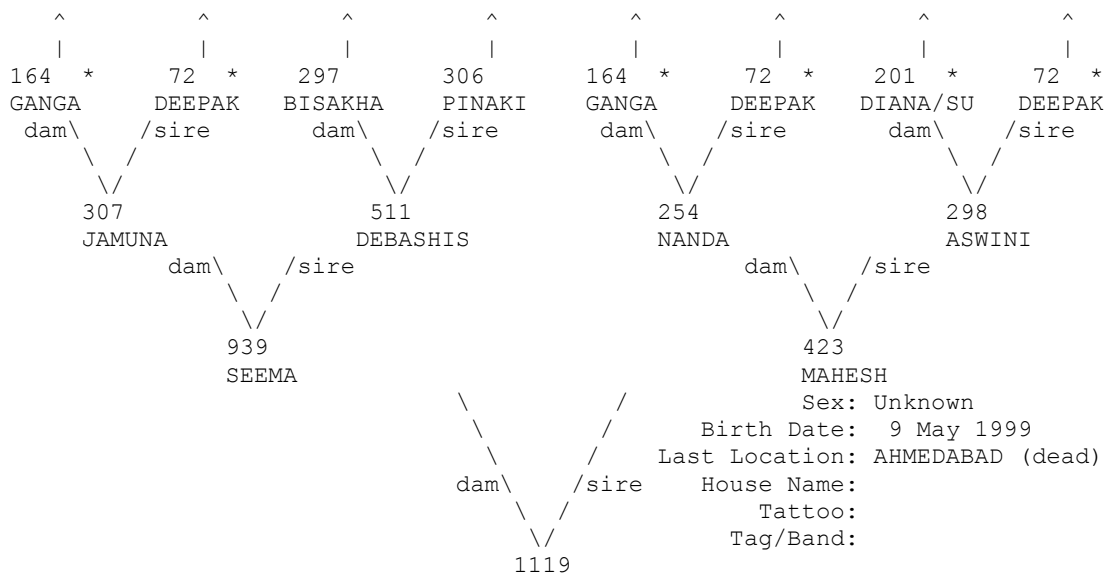

* Appear more than once...
 ^ Pedigree continues beyond top of page...

=====

Taxon Name: PANTHERA TIGRIS Studbook Number: 1120

=====

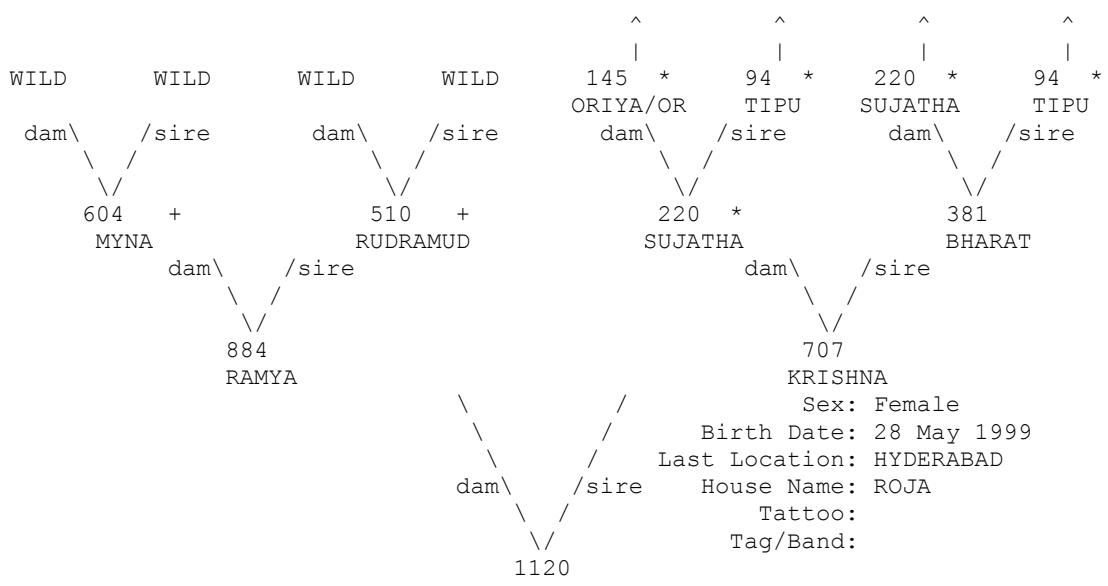

+ Wild-caught... * Appear more than once...
 ^ Pedigree continues beyond top of page...

=====
 Taxon Name: PANTHERA TIGRIS Studbook Number: 1121
 =====

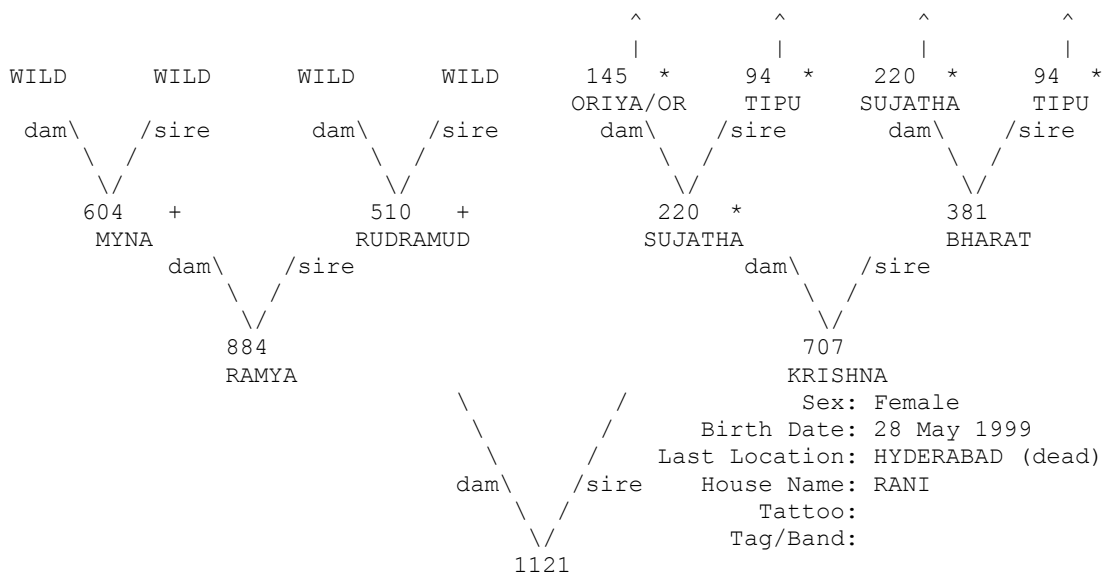

+ Wild-caught... * Appear more than once...
 ^ Pedigree continues beyond top of page...

=====
 Taxon Name: PANTHERA TIGRIS Studbook Number: 1122
 =====

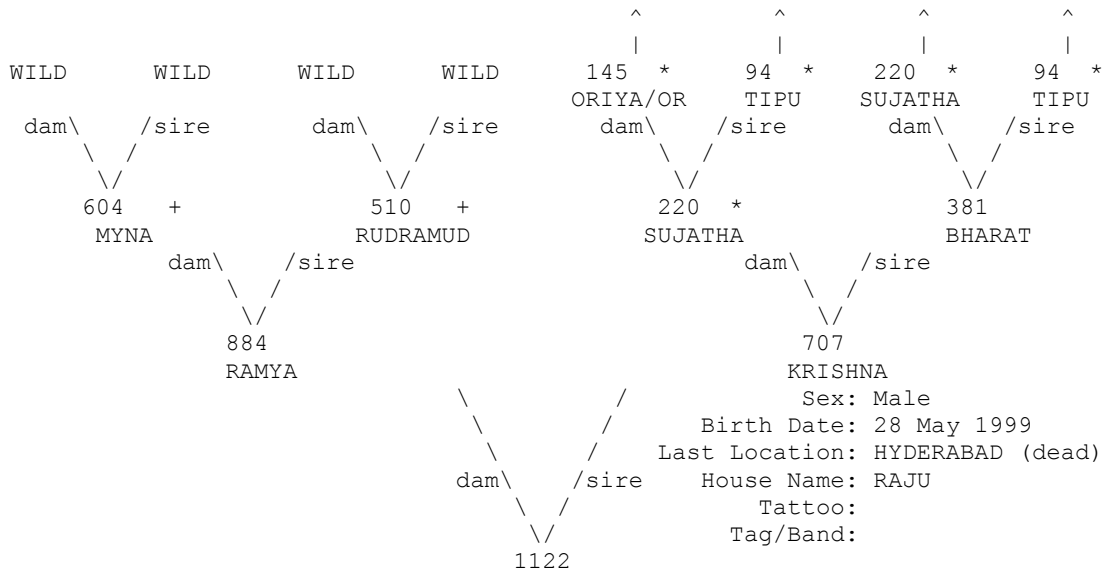

+ Wild-caught... * Appear more than once...
 ^ Pedigree continues beyond top of page...

=====
 Taxon Name: PANTHERA TIGRIS Studbook Number: 1127
 =====

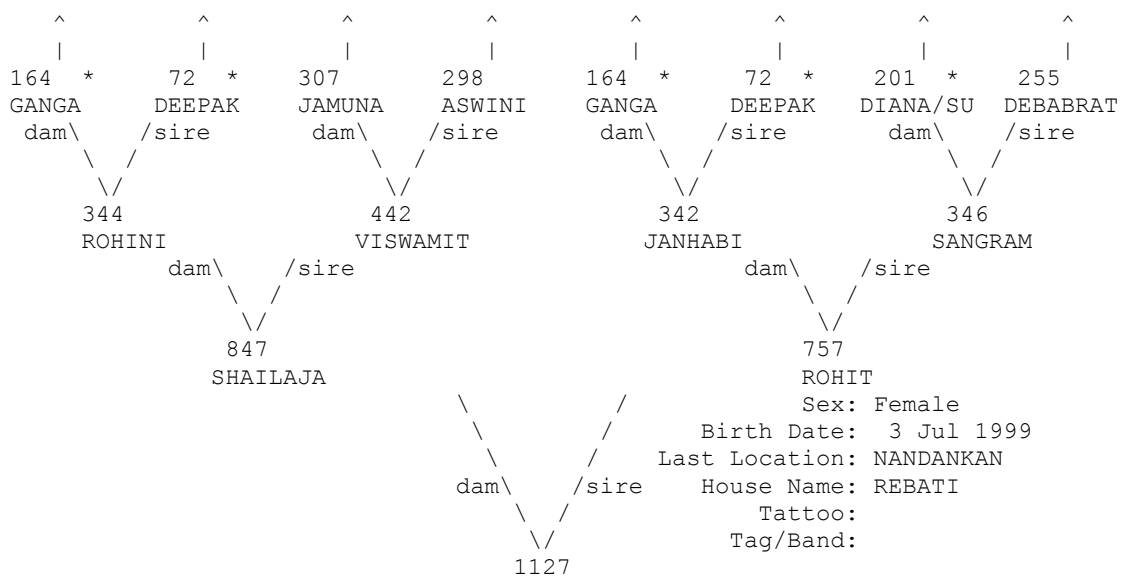

* Appear more than once...
 ^ Pedigree continues beyond top of page...

=====
 Taxon Name: PANTHERA TIGRIS Studbook Number: 1128
 =====

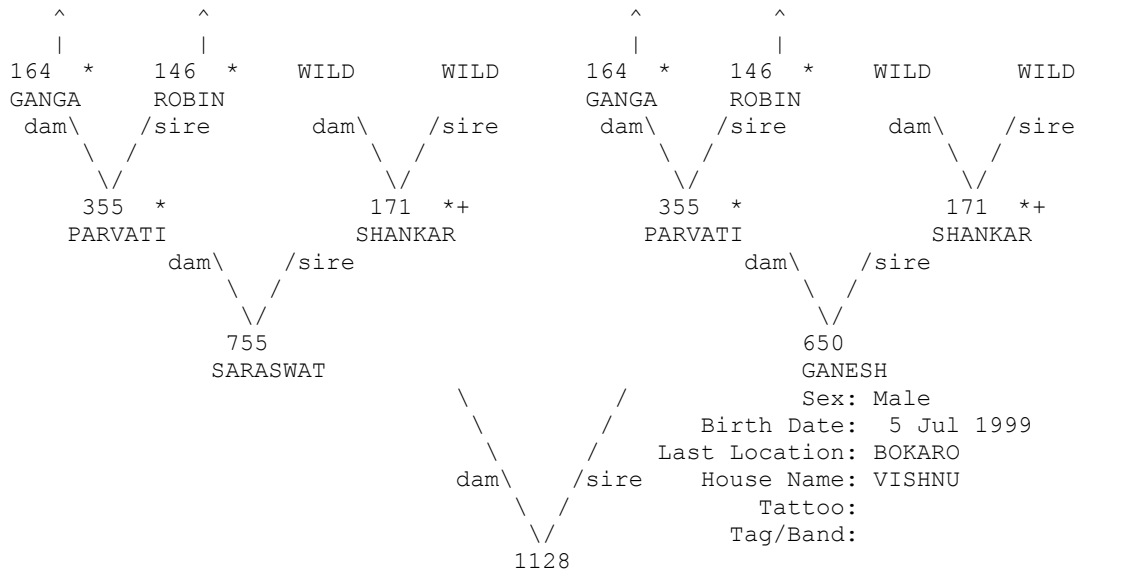

+ Wild-caught... * Appear more than once...
 ^ Pedigree continues beyond top of page...

=====
 Taxon Name: PANTHERA TIGRIS Studbook Number: 1129
 =====

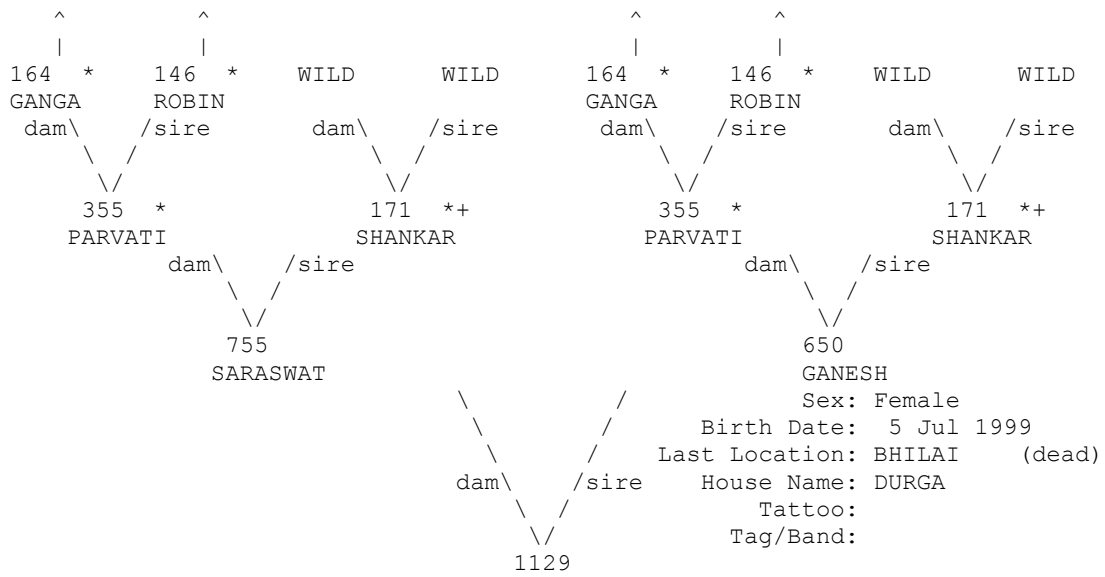

+ Wild-caught... * Appear more than once...
 ^ Pedigree continues beyond top of page...

=====
 Taxon Name: PANTHERA TIGRIS Studbook Number: 1130
 =====

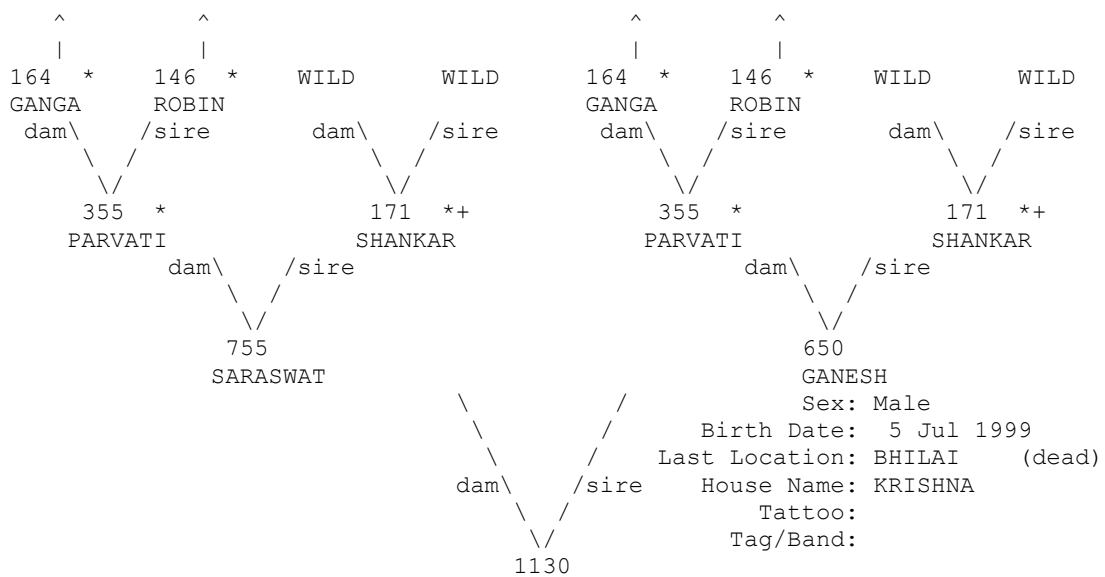

+ Wild-caught... * Appear more than once...
 ^ Pedigree continues beyond top of page...

=====
 Taxon Name: PANTHERA TIGRIS Studbook Number: 1131
 =====

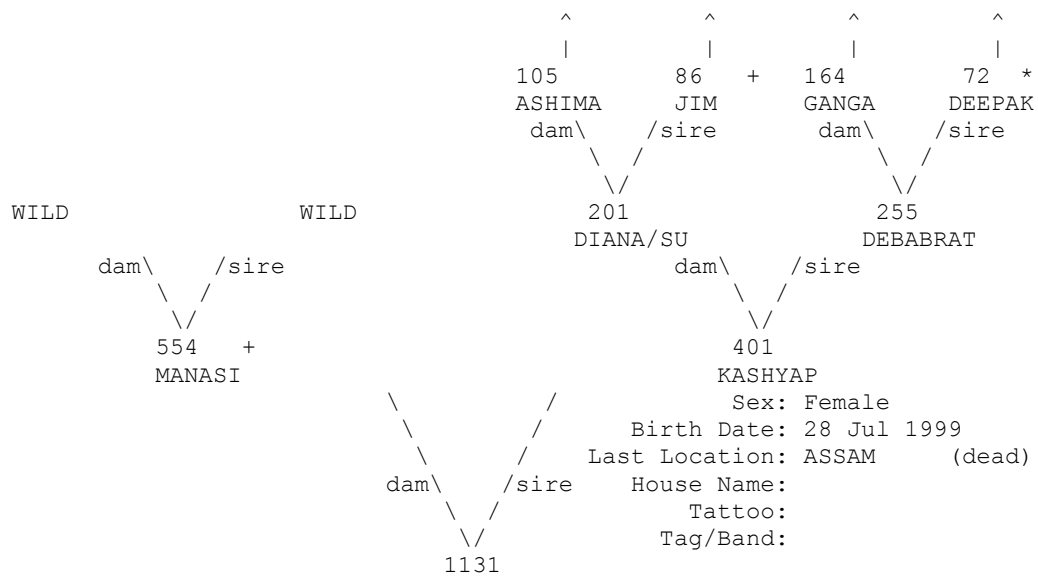

+ Wild-caught... * Appear more than once...
 ^ Pedigree continues beyond top of page...

=====
 Taxon Name: PANTHERA TIGRIS Studbook Number: 1132
 =====

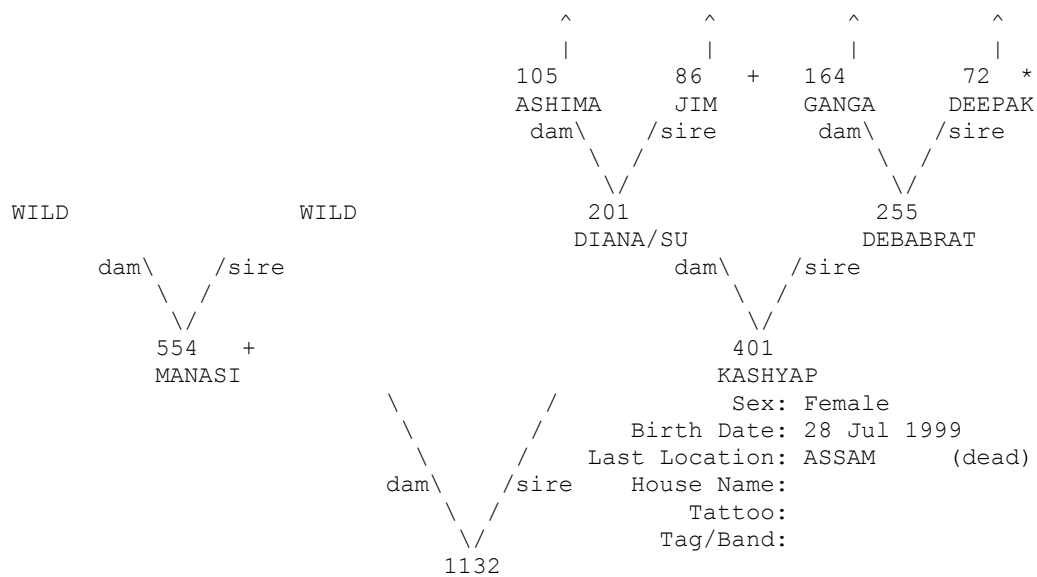

+ Wild-caught... * Appear more than once...
 ^ Pedigree continues beyond top of page...

=====
 Taxon Name: PANTHERA TIGRIS Studbook Number: 1133
 =====

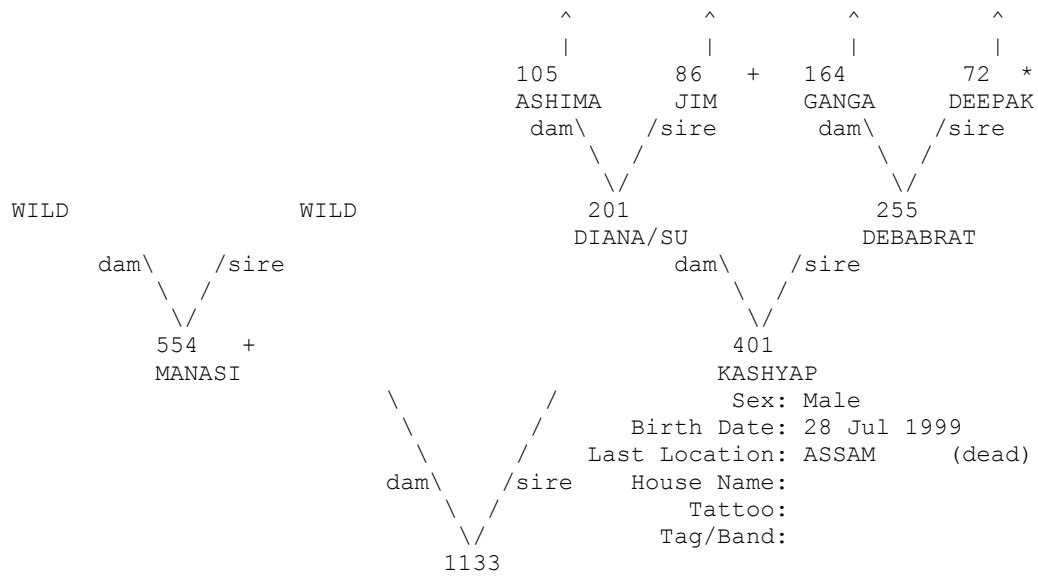

+ Wild-caught... * Appear more than once...
 ^ Pedigree continues beyond top of page...

=====
 Taxon Name: PANTHERA TIGRIS Studbook Number: 1134
 =====

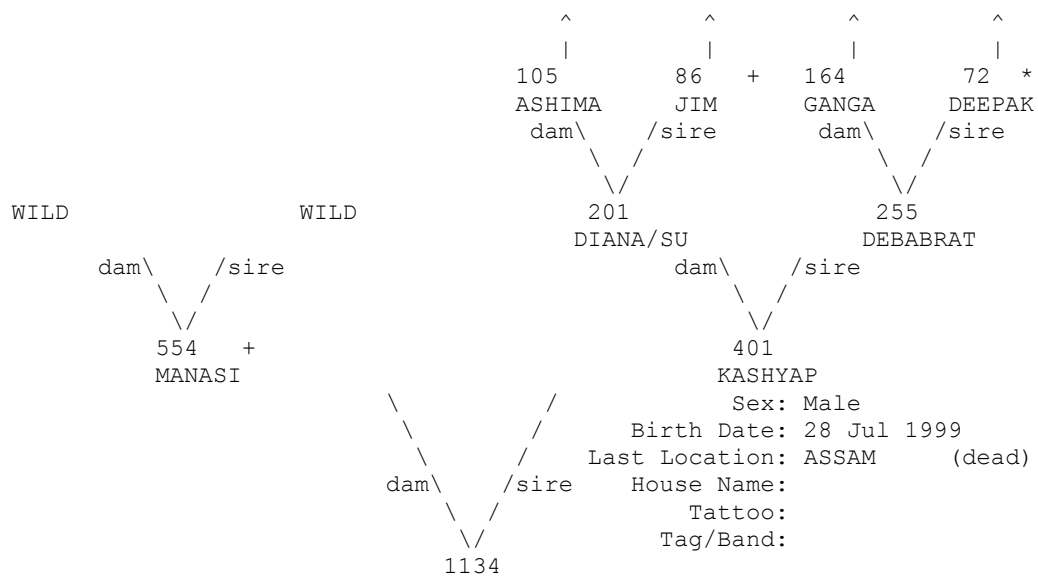

+ Wild-caught... * Appear more than once...
 ^ Pedigree continues beyond top of page...

=====
 Taxon Name: PANTHERA TIGRIS Studbook Number: 1135
 =====

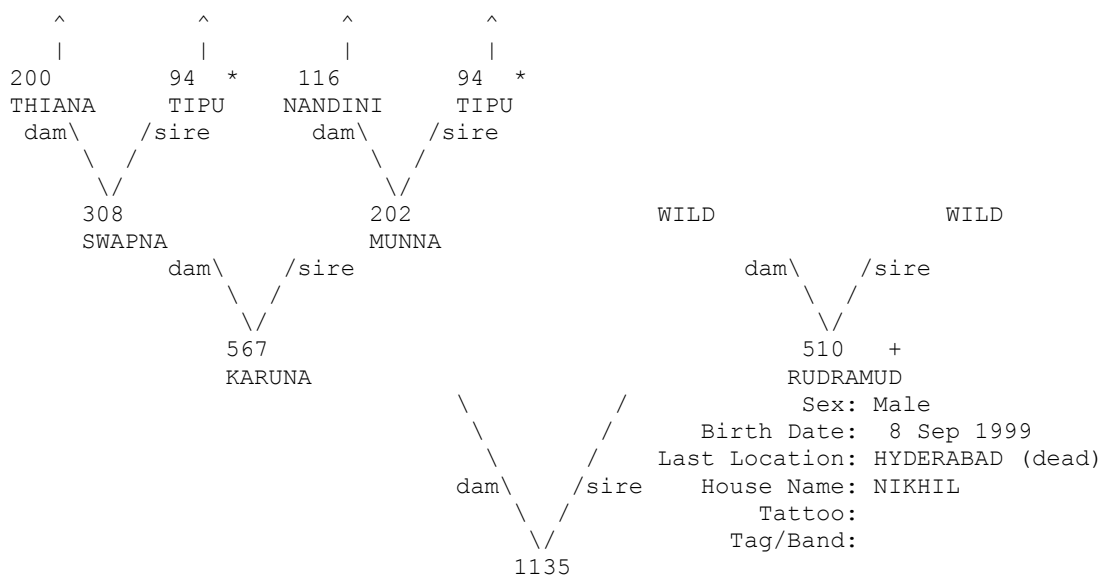

+ Wild-caught... * Appear more than once...
 ^ Pedigree continues beyond top of page...

=====
 Taxon Name: PANTHERA TIGRIS Studbook Number: 1136
 =====

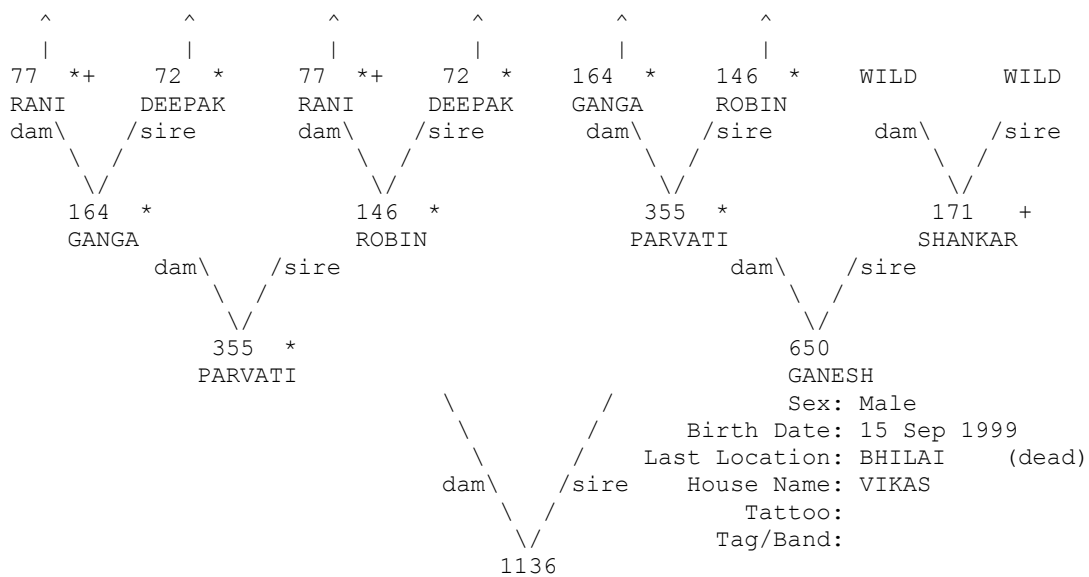

+ Wild-caught... * Appear more than once...
 ^ Pedigree continues beyond top of page...

=====
 Taxon Name: PANTHERA TIGRIS Studbook Number: 1137
 =====

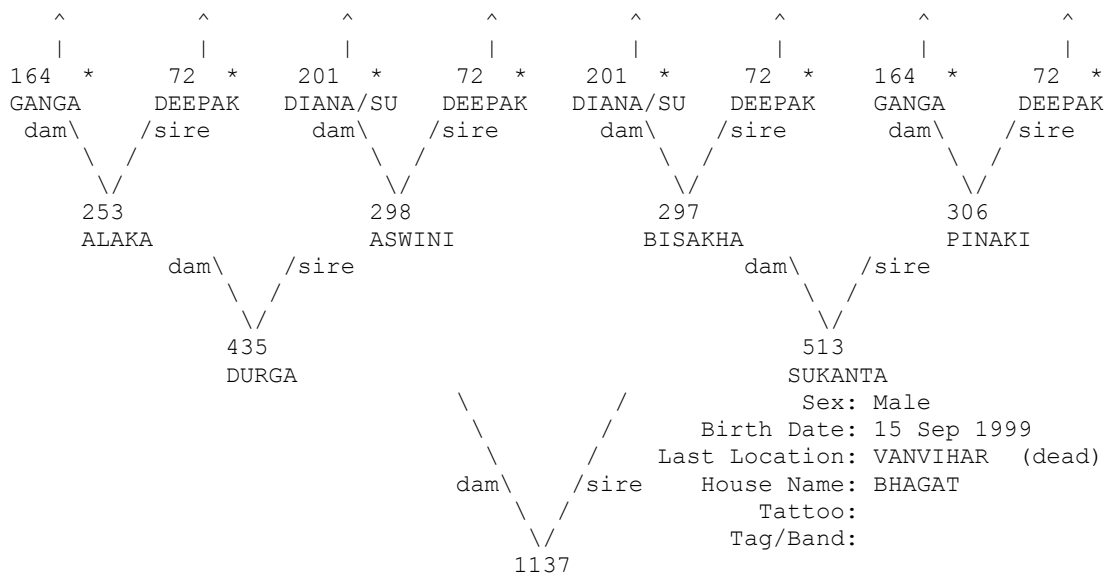

* Appear more than once...
 ^ Pedigree continues beyond top of page...

=====
 Taxon Name: PANTHERA TIGRIS Studbook Number: 1138
 =====

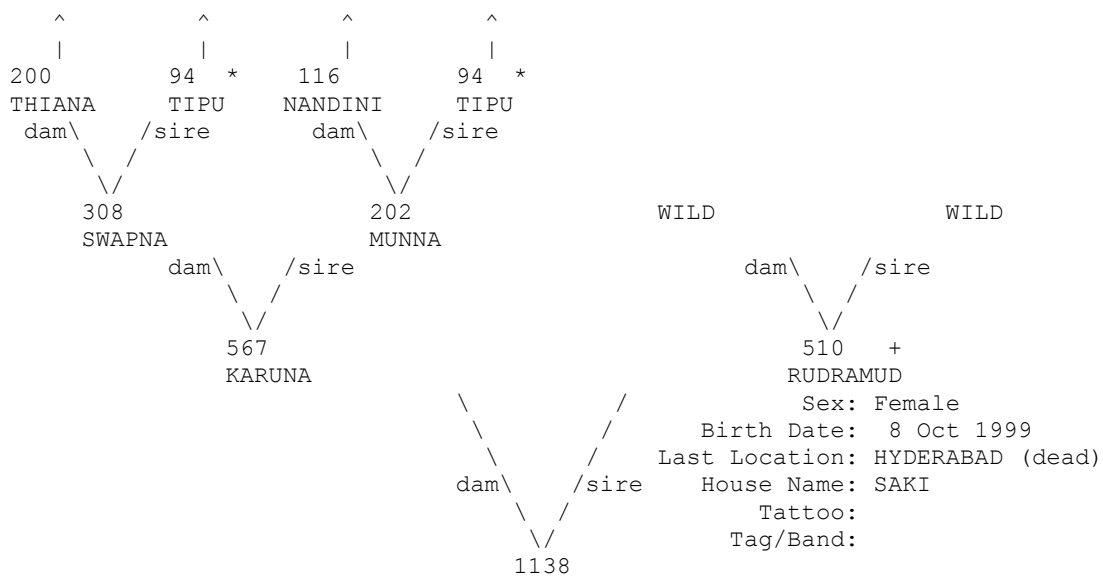

+ Wild-caught... * Appear more than once...
 ^ Pedigree continues beyond top of page...

=====
 Taxon Name: PANTHERA TIGRIS Studbook Number: 1139
 =====

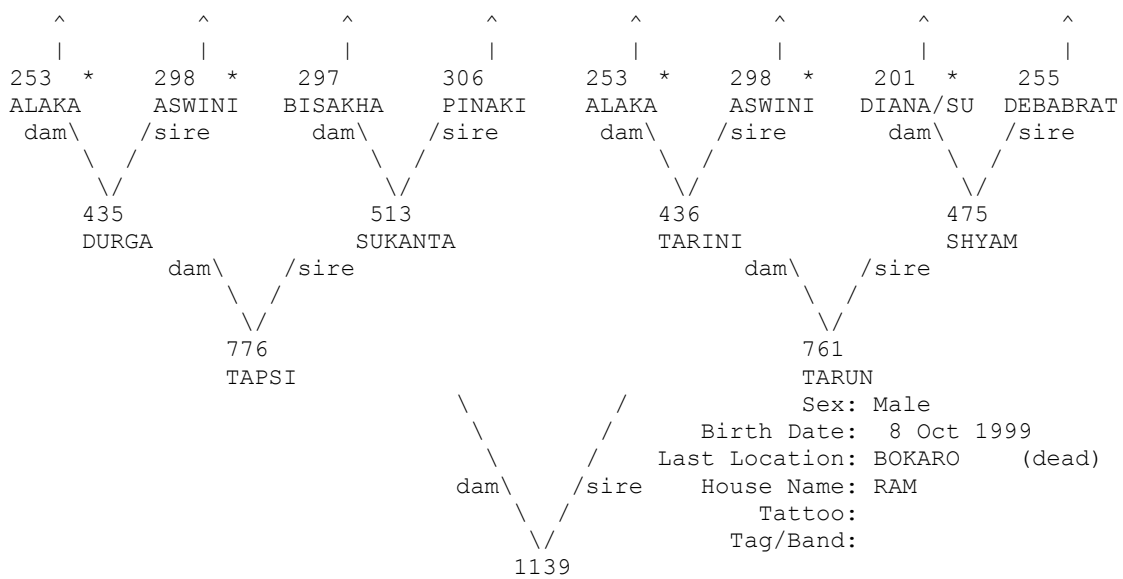

* Appear more than once...
 ^ Pedigree continues beyond top of page...

=====
 Taxon Name: PANTHERA TIGRIS Studbook Number: 1140
 =====

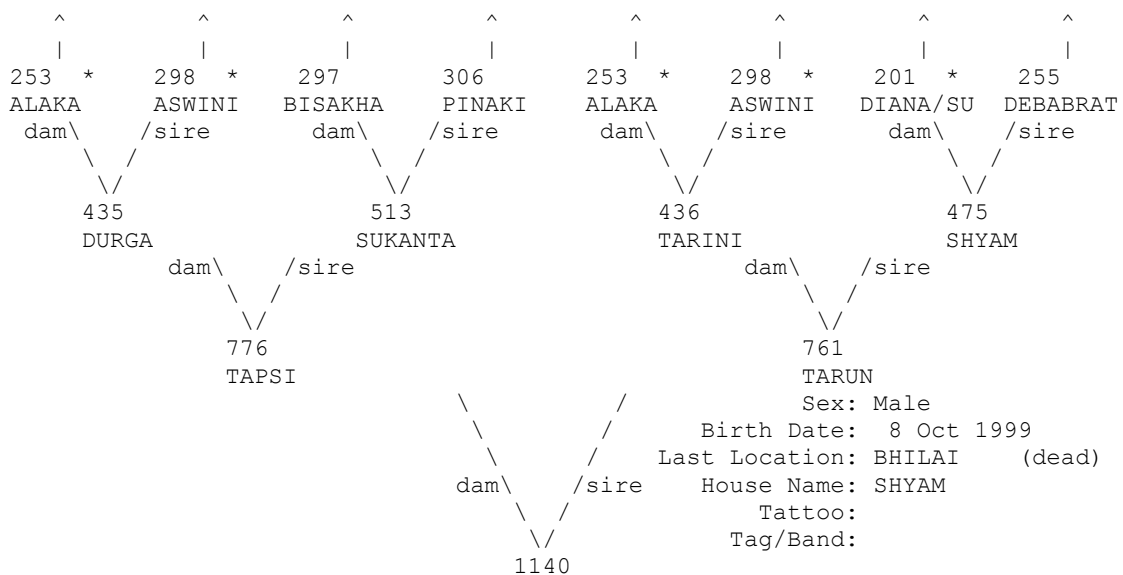

* Appear more than once...
 ^ Pedigree continues beyond top of page...

=====
 Taxon Name: PANTHERA TIGRIS Studbook Number: 1141
 =====

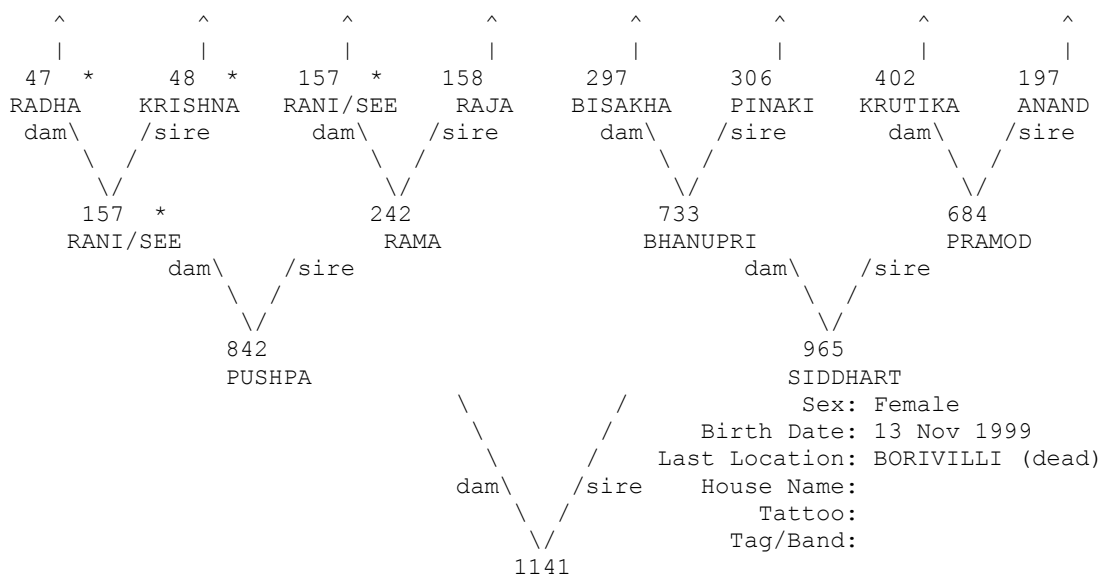

* Appear more than once...
 ^ Pedigree continues beyond top of page...

=====
 Taxon Name: PANTHERA TIGRIS Studbook Number: 1142
 =====

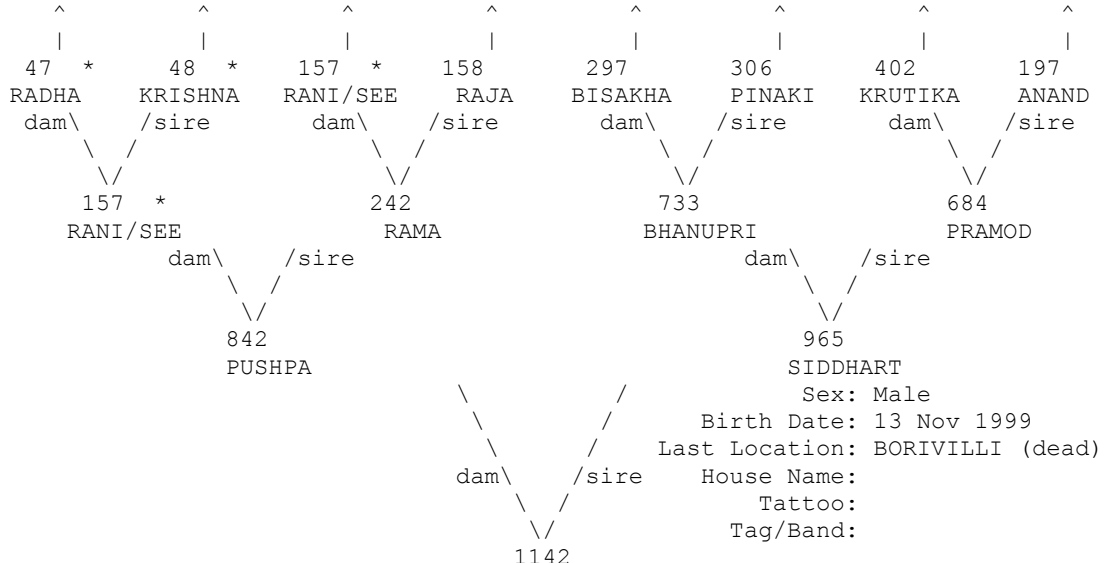

* Appear more than once...
 ^ Pedigree continues beyond top of page...

=====
 Taxon Name: PANTHERA TIGRIS Studbook Number: 1143
 =====

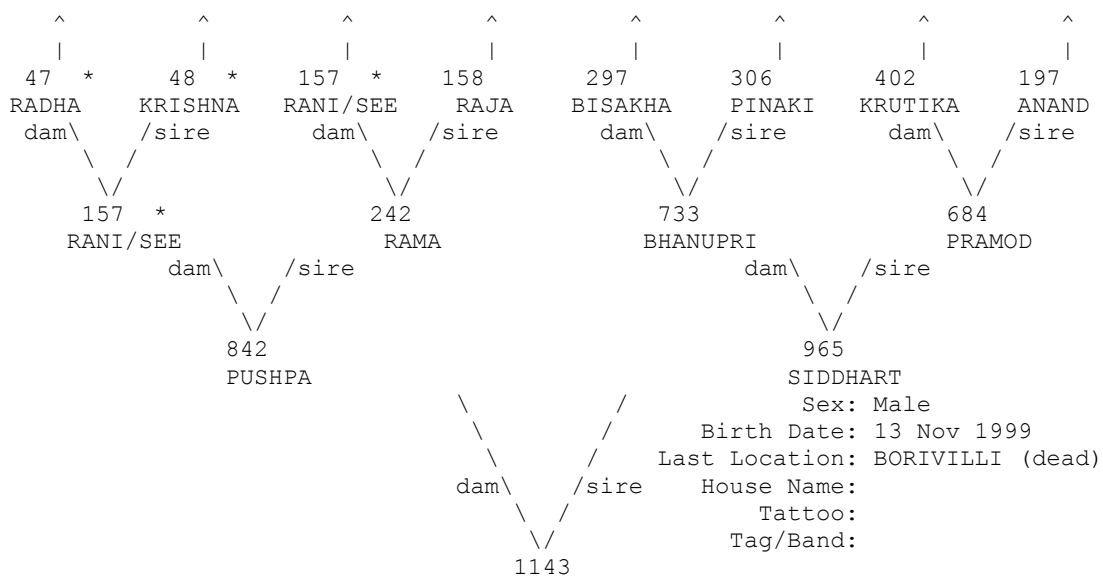

* Appear more than once...
 ^ Pedigree continues beyond top of page...

=====
 Taxon Name: PANTHERA TIGRIS Studbook Number: 1144
 =====

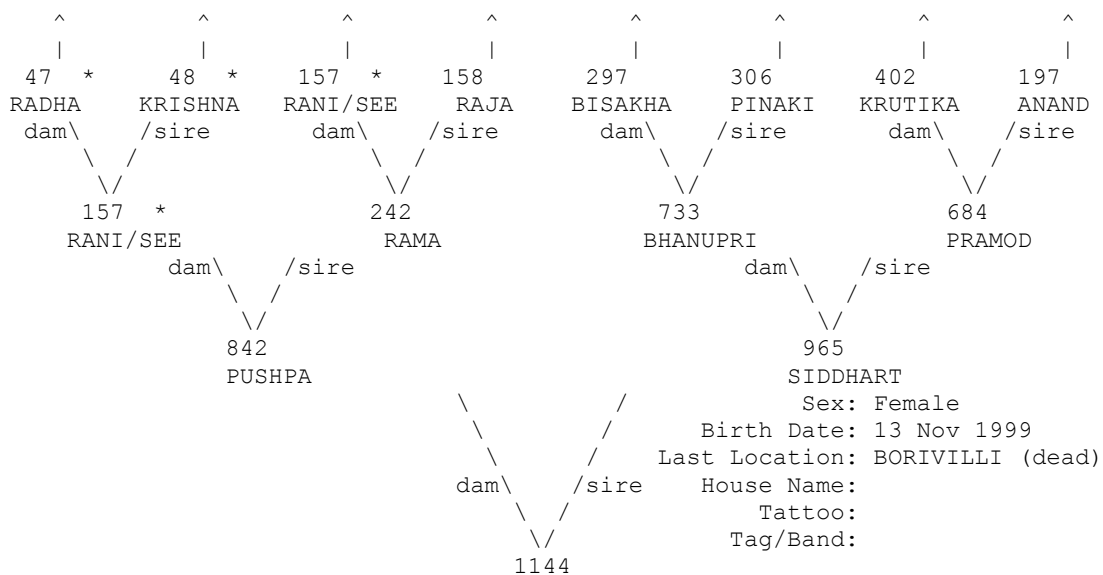

* Appear more than once...
 ^ Pedigree continues beyond top of page...

=====
 Taxon Name: PANTHERA TIGRIS Studbook Number: 1145
 =====

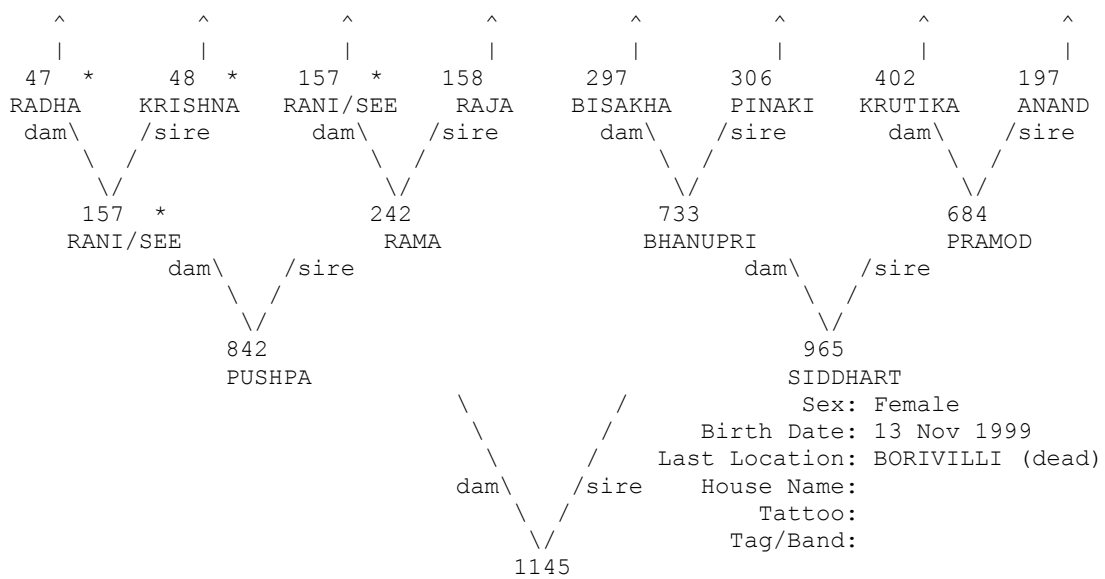

* Appear more than once...
 ^ Pedigree continues beyond top of page...

=====
 Taxon Name: PANTHERA TIGRIS Studbook Number: 1146
 =====

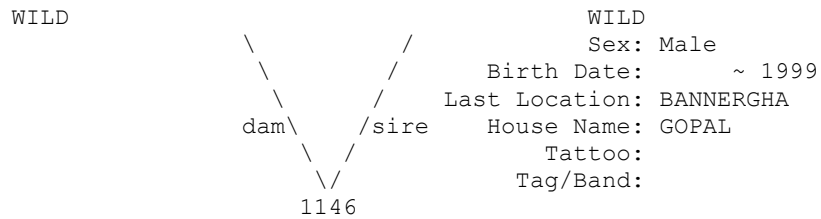

=====
 Taxon Name: PANTHERA TIGRIS Studbook Number: 1147
 =====

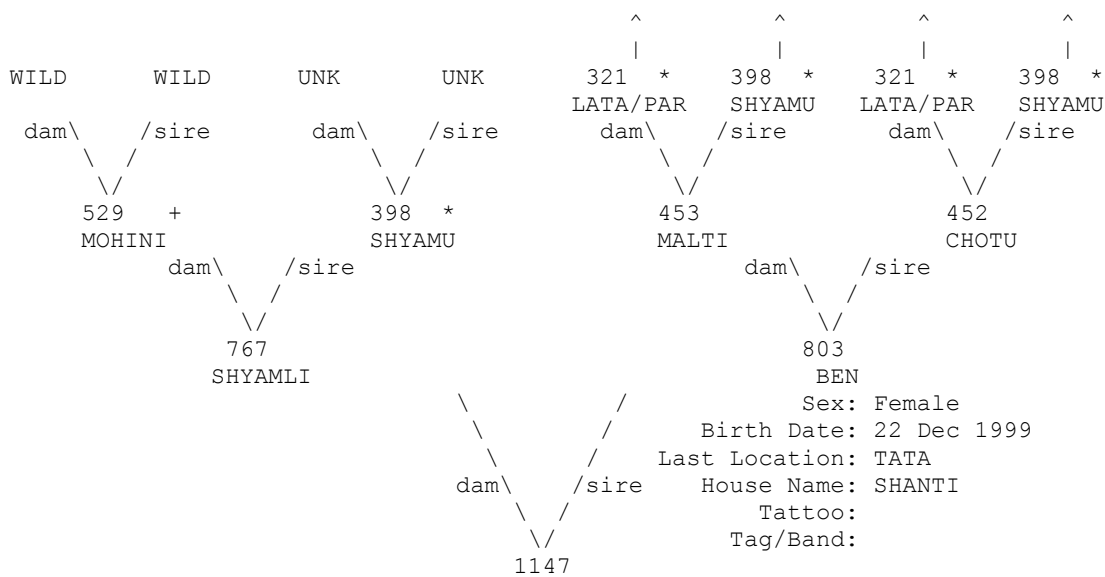

+ Wild-caught... * Appear more than once...
 ^ Pedigree continues beyond top of page...

=====
 Taxon Name: PANTHERA TIGRIS Studbook Number: 1148
 =====

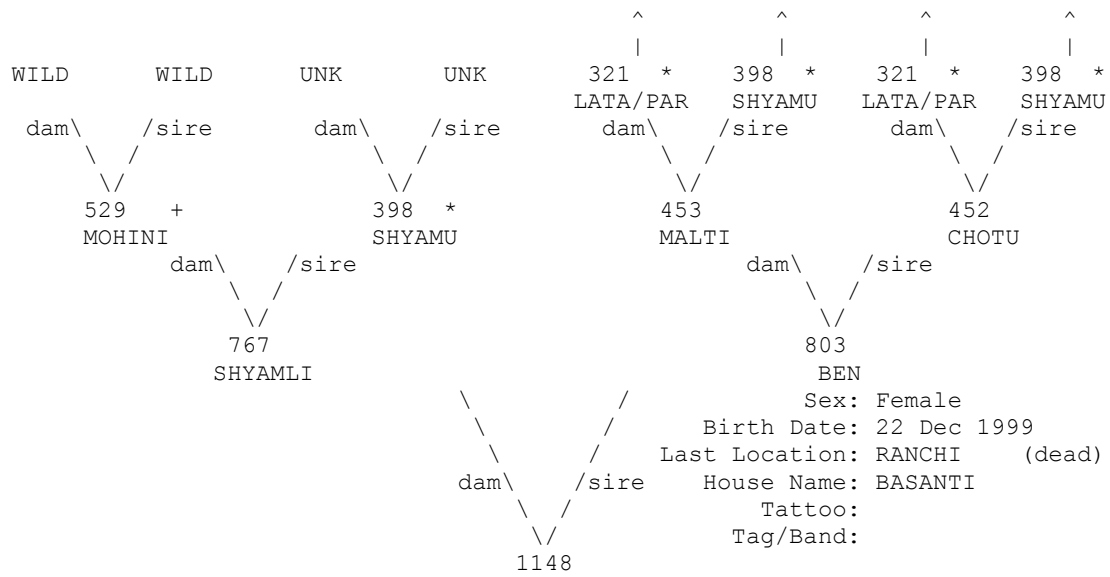

+ Wild-caught... * Appear more than once...
 ^ Pedigree continues beyond top of page...

=====
 Taxon Name: PANTHERA TIGRIS Studbook Number: 1149
 =====

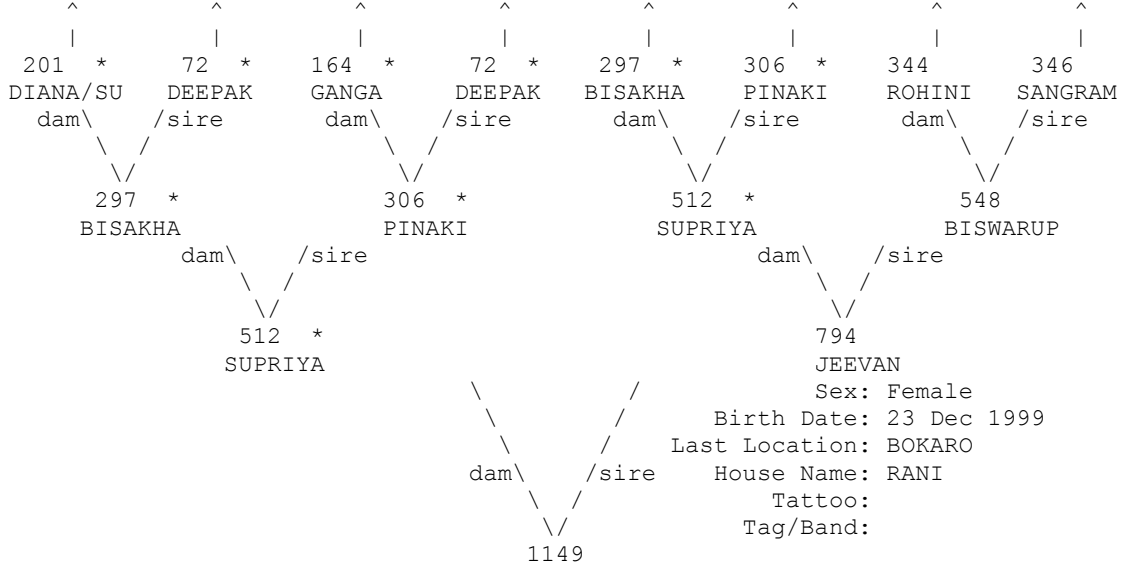

* Appear more than once...
 ^ Pedigree continues beyond top of page...

=====
 Taxon Name: PANTHERA TIGRIS Studbook Number: 1150
 =====

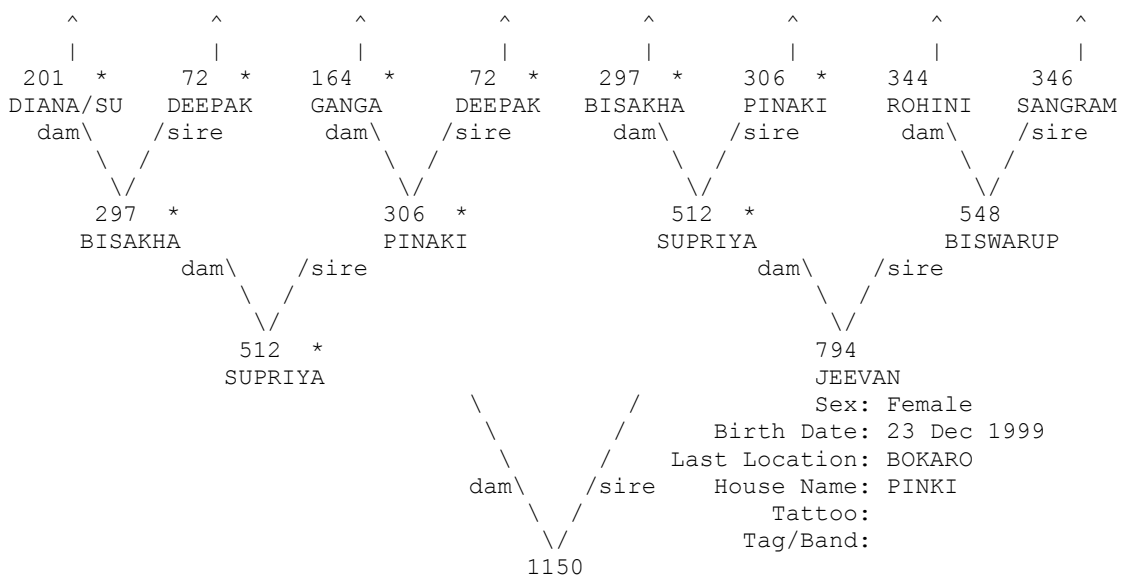

* Appear more than once...
 ^ Pedigree continues beyond top of page...

=====
 Taxon Name: PANTHERA TIGRIS Studbook Number: 1151
 =====

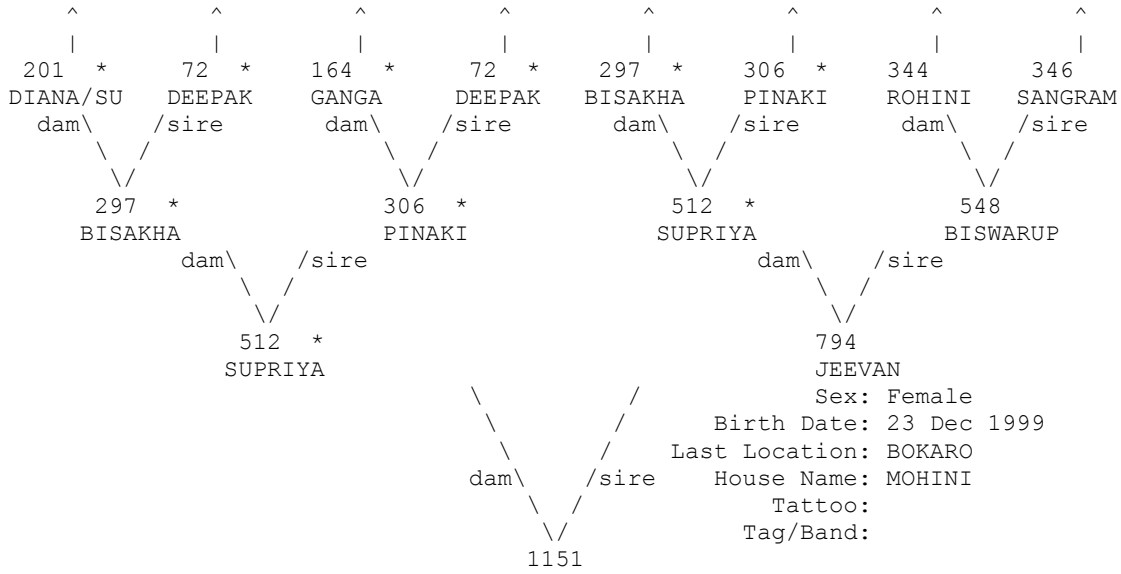

* Appear more than once...
 ^ Pedigree continues beyond top of page...

=====
 Taxon Name: PANTHERA TIGRIS Studbook Number: 1152
 =====

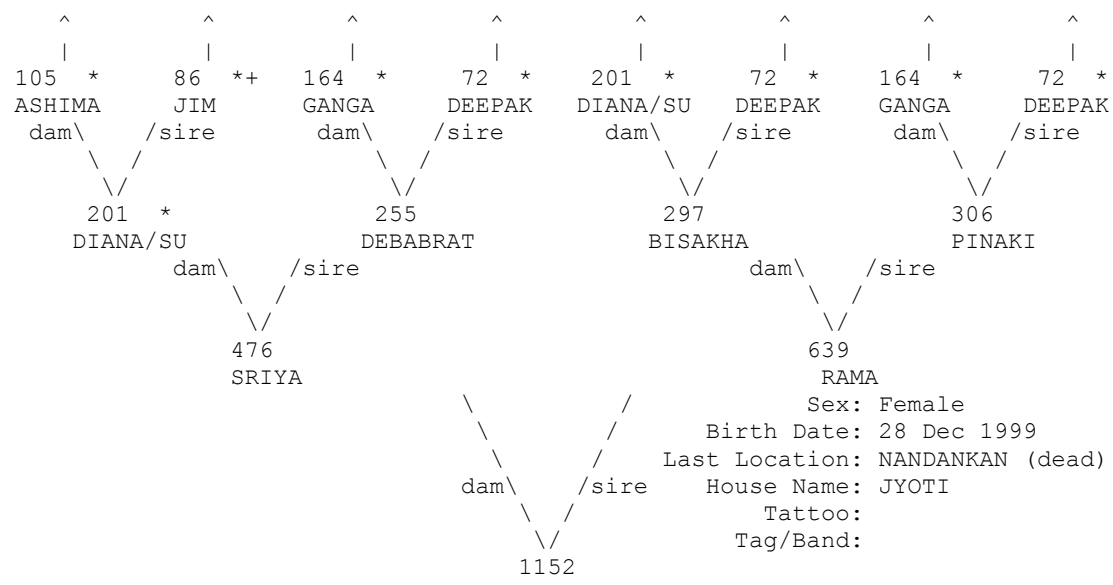

+ Wild-caught... * Appear more than once...
 ^ Pedigree continues beyond top of page...

=====
 Taxon Name: PANTHERA TIGRIS Studbook Number: 1153
 =====

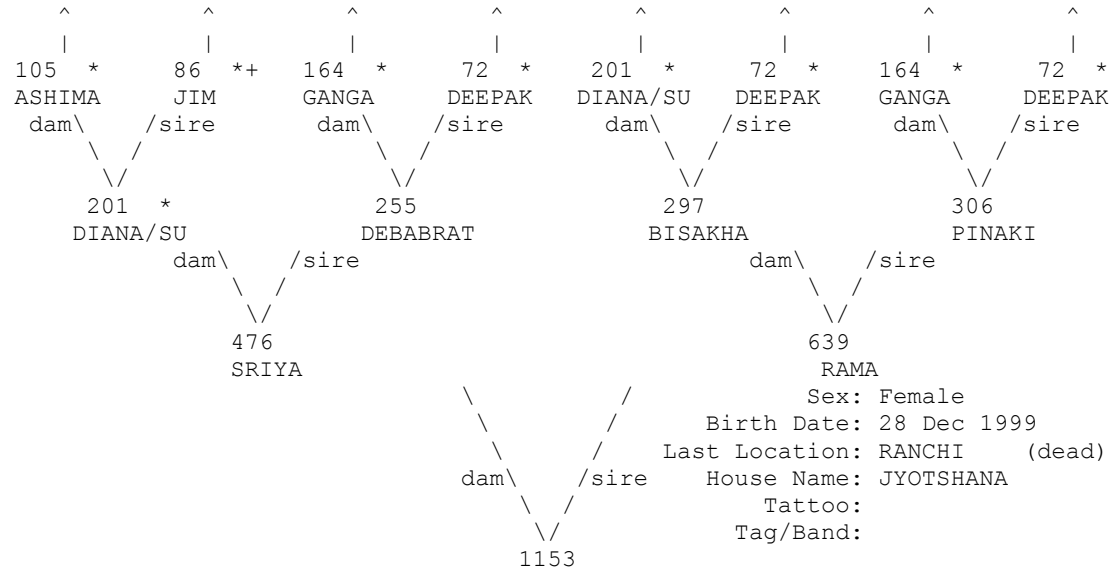

+ Wild-caught... * Appear more than once...
 ^ Pedigree continues beyond top of page...

=====
 Taxon Name: PANTHERA TIGRIS Studbook Number: 1154
 =====

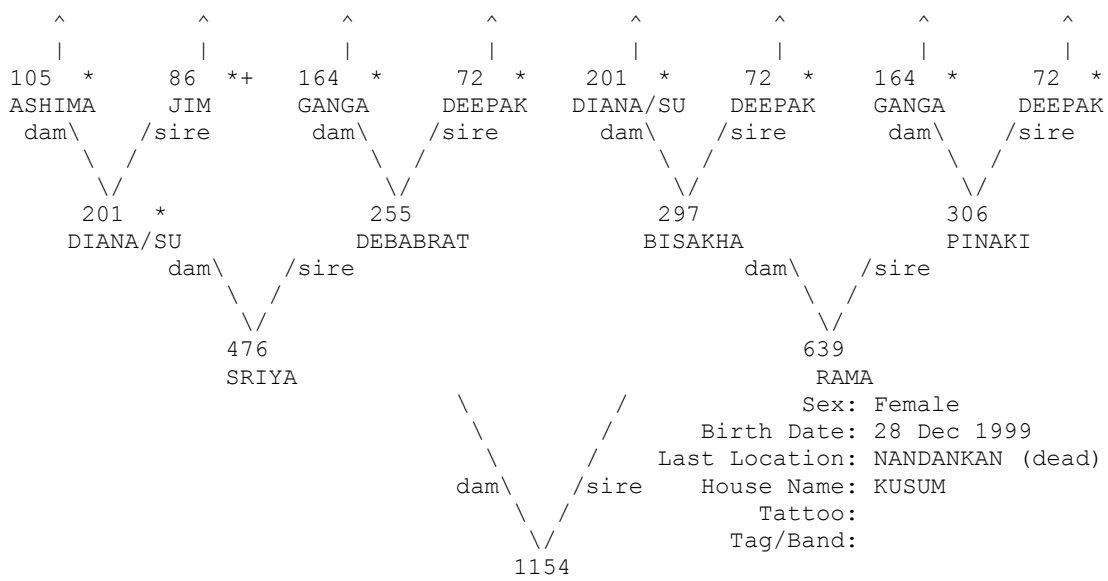

+ Wild-caught... * Appear more than once...
 ^ Pedigree continues beyond top of page...

=====
 Taxon Name: PANTHERA TIGRIS Studbook Number: 1155
 =====

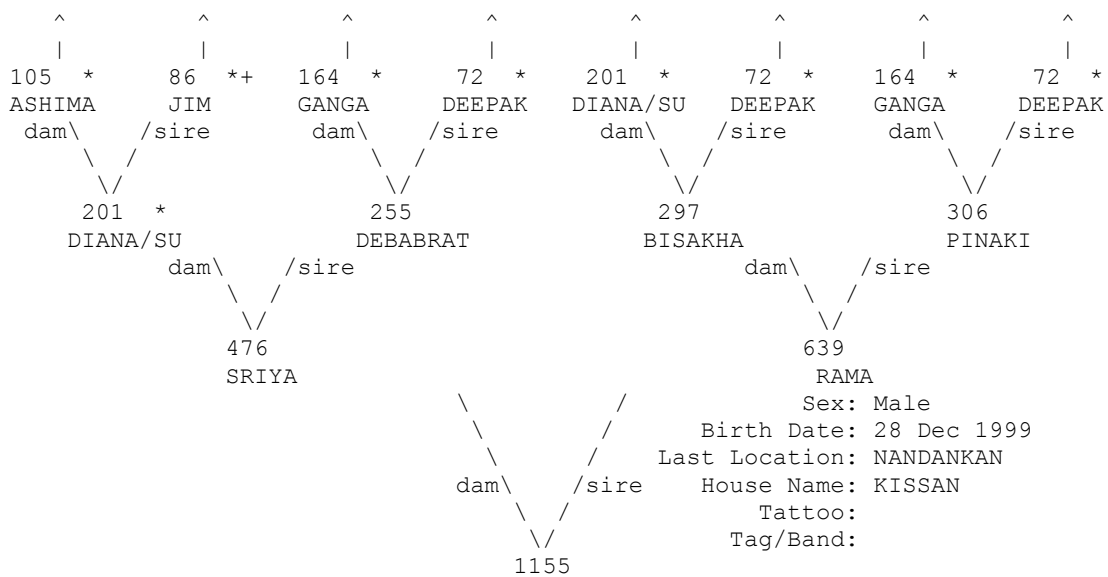

+ Wild-caught... * Appear more than once...
 ^ Pedigree continues beyond top of page...

=====
 Taxon Name: PANTHERA TIGRIS Studbook Number: 1156
 =====

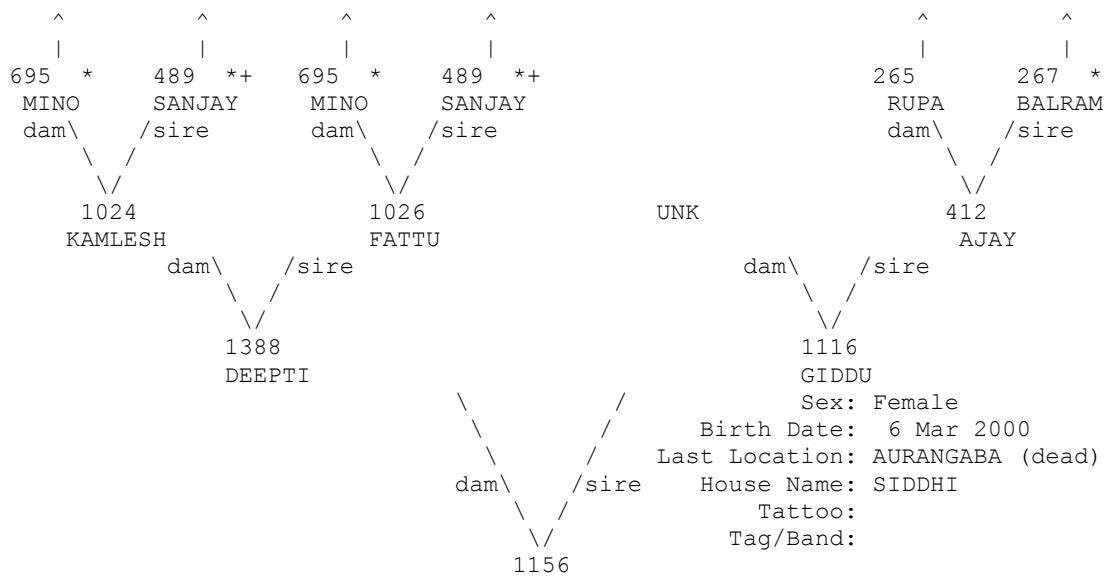

+ Wild-caught... * Appear more than once...
 ^ Pedigree continues beyond top of page...

=====
 Taxon Name: PANTHERA TIGRIS Studbook Number: 1157
 =====

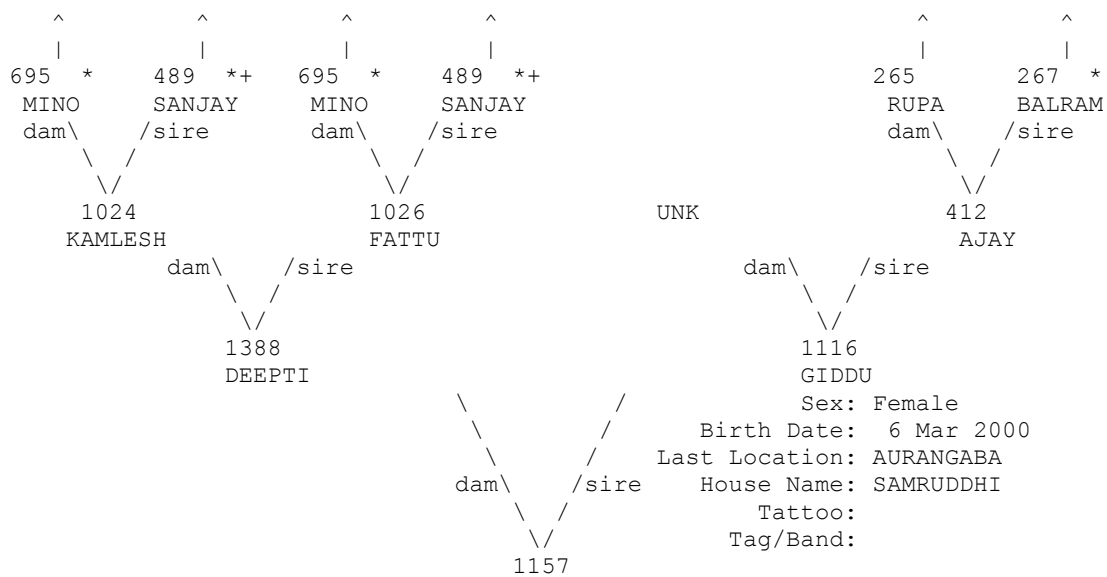

+ Wild-caught... * Appear more than once...
 ^ Pedigree continues beyond top of page...

=====
 Taxon Name: PANTHERA TIGRIS Studbook Number: 1158
 =====

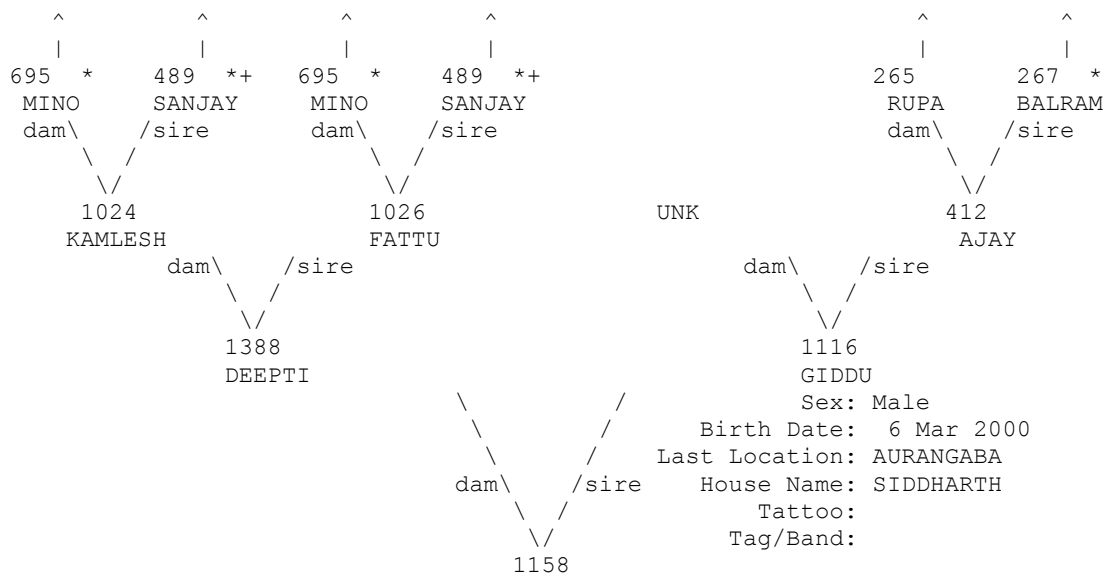

+ Wild-caught... * Appear more than once...
 ^ Pedigree continues beyond top of page...

=====
 Taxon Name: PANTHERA TIGRIS Studbook Number: 1159
 =====

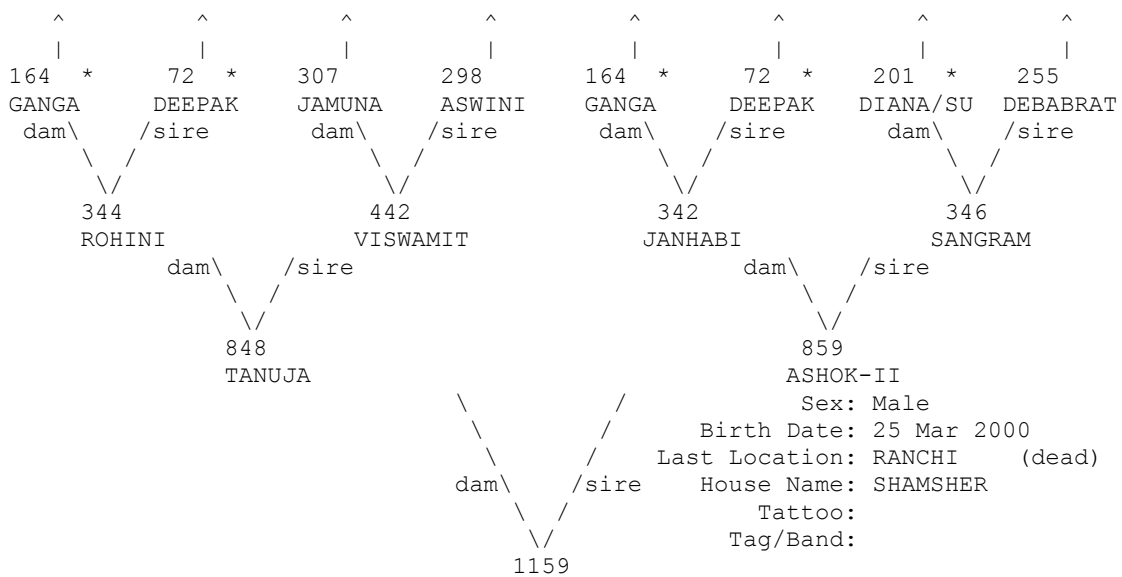

* Appear more than once...
 ^ Pedigree continues beyond top of page...

=====
 Taxon Name: PANTHERA TIGRIS Studbook Number: 1160
 =====

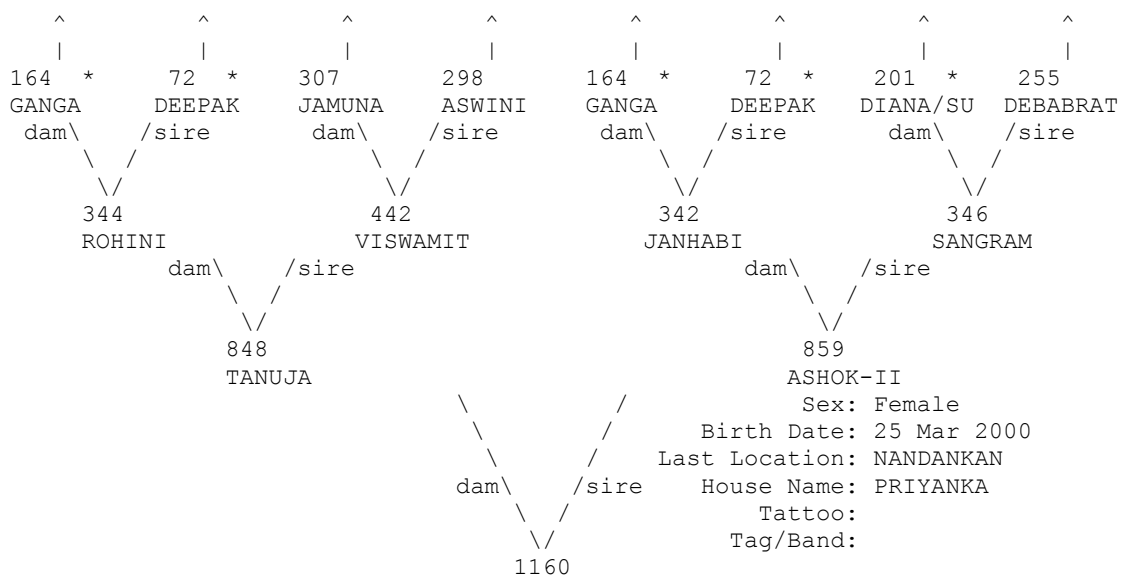

* Appear more than once...
 ^ Pedigree continues beyond top of page...

=====
 Taxon Name: PANTHERA TIGRIS Studbook Number: 1161
 =====

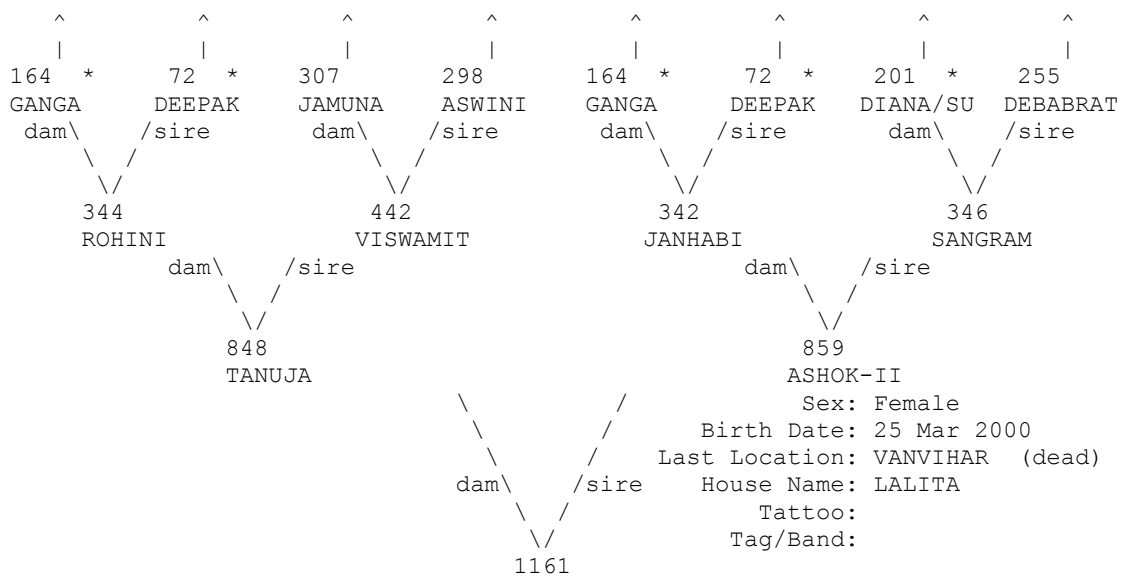

* Appear more than once...
 ^ Pedigree continues beyond top of page...

=====
 Taxon Name: PANTHERA TIGRIS Studbook Number: 1162
 =====

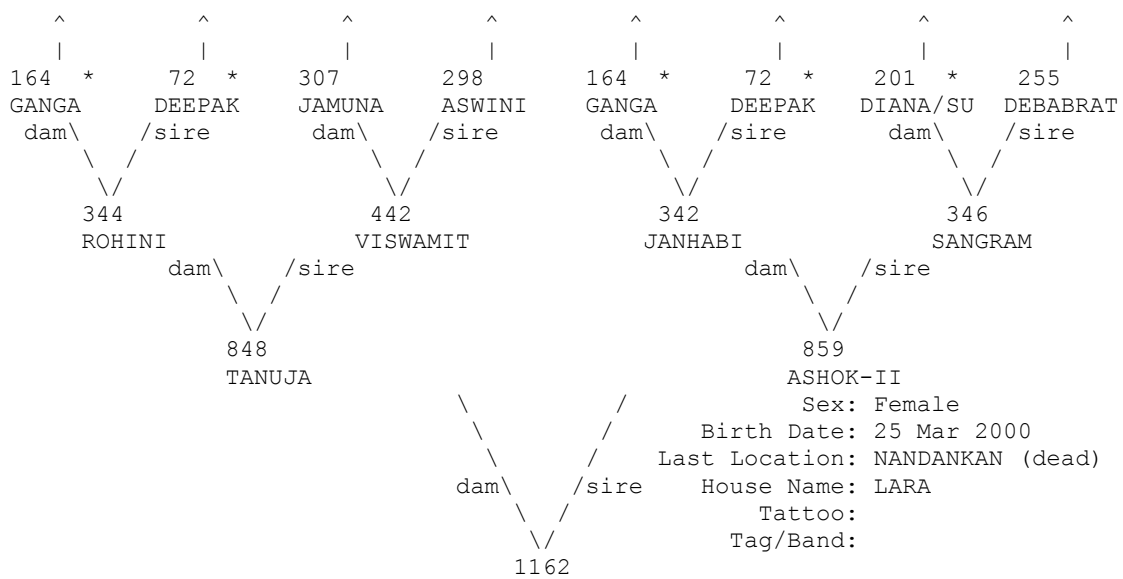

* Appear more than once...
 ^ Pedigree continues beyond top of page...

=====
 Taxon Name: PANTHERA TIGRIS Studbook Number: 1163
 =====

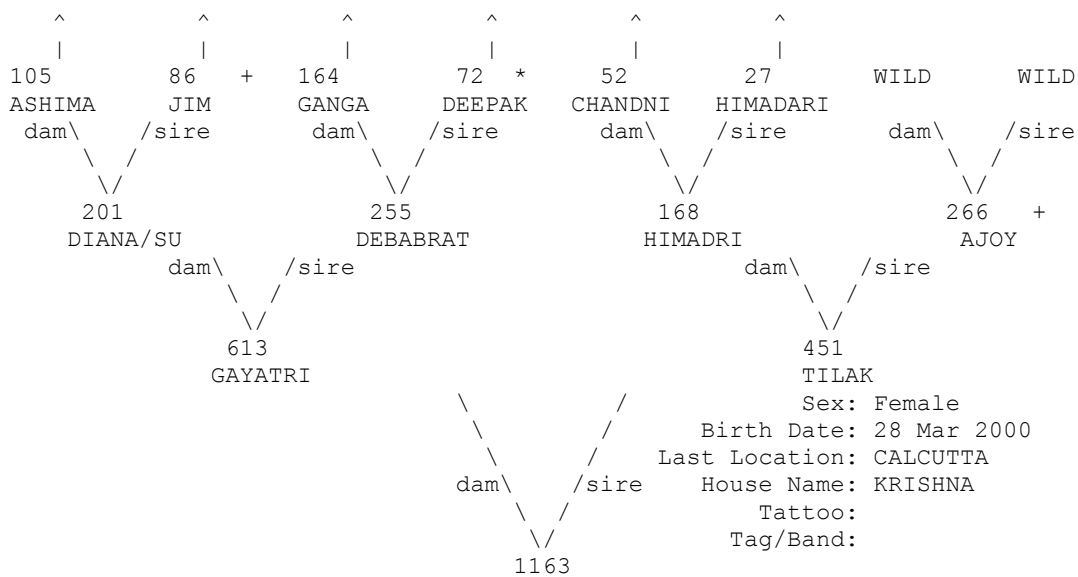

+ Wild-caught... * Appear more than once...
 ^ Pedigree continues beyond top of page...

=====
 Taxon Name: PANTHERA TIGRIS Studbook Number: 1164
 =====

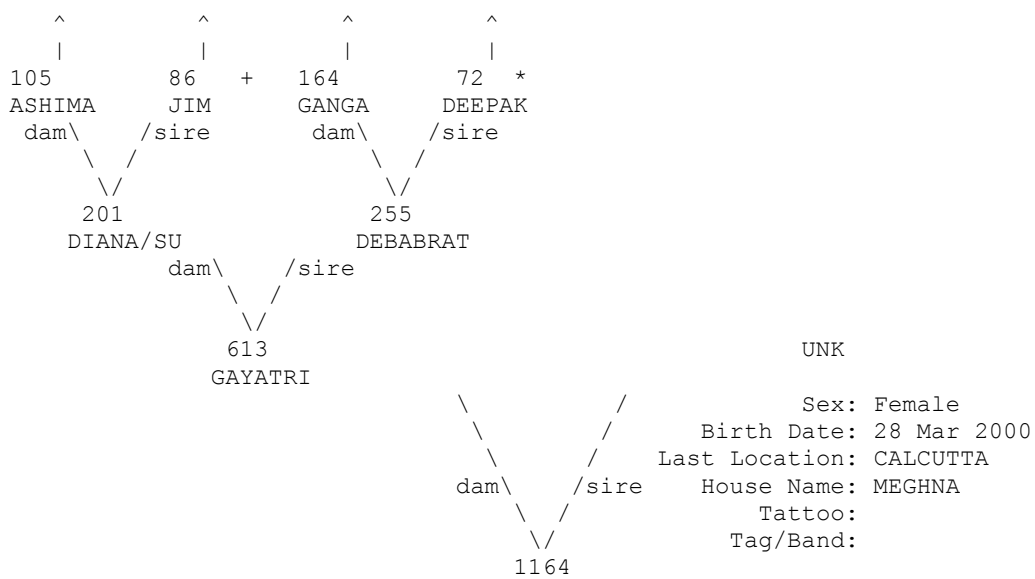

+ Wild-caught... * Appear more than once...
 ^ Pedigree continues beyond top of page...

=====
 Taxon Name: PANTHERA TIGRIS Studbook Number: 1165
 =====

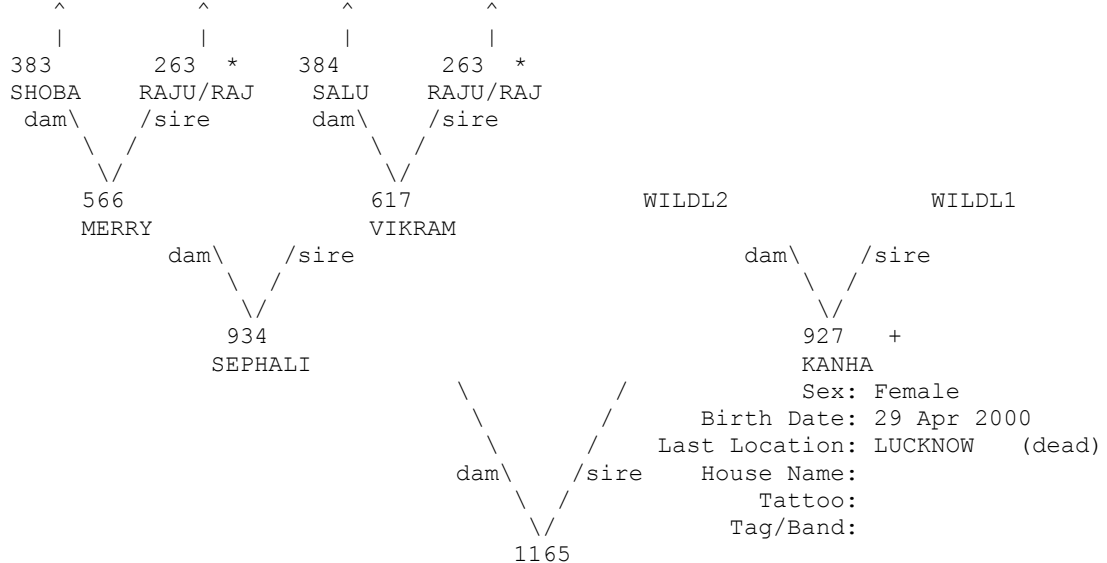

+ Wild-caught... * Appear more than once...
 ^ Pedigree continues beyond top of page...

=====
 Taxon Name: PANTHERA TIGRIS Studbook Number: 1166
 =====

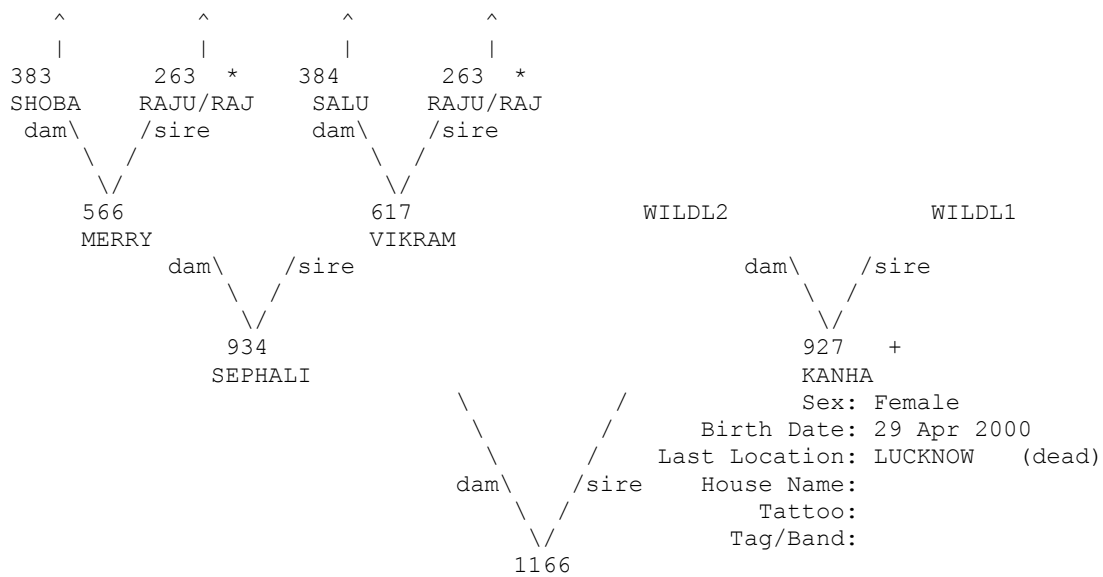

+ Wild-caught... * Appear more than once...
 ^ Pedigree continues beyond top of page...

=====
 Taxon Name: PANTHERA TIGRIS Studbook Number: 1167
 =====

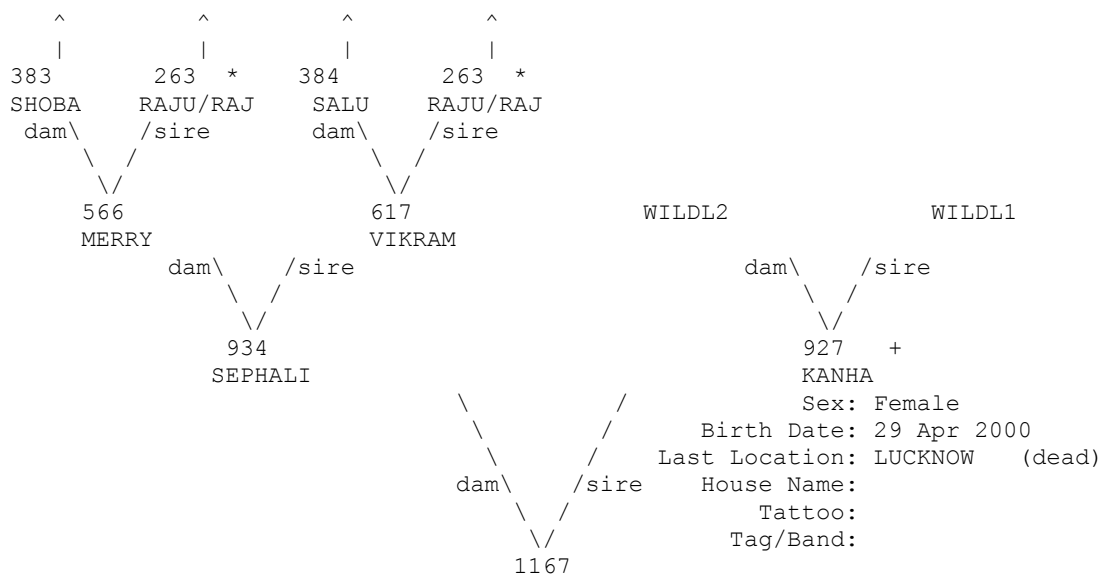

+ Wild-caught... * Appear more than once...
 ^ Pedigree continues beyond top of page...

=====
 Taxon Name: PANTHERA TIGRIS Studbook Number: 1171
 =====

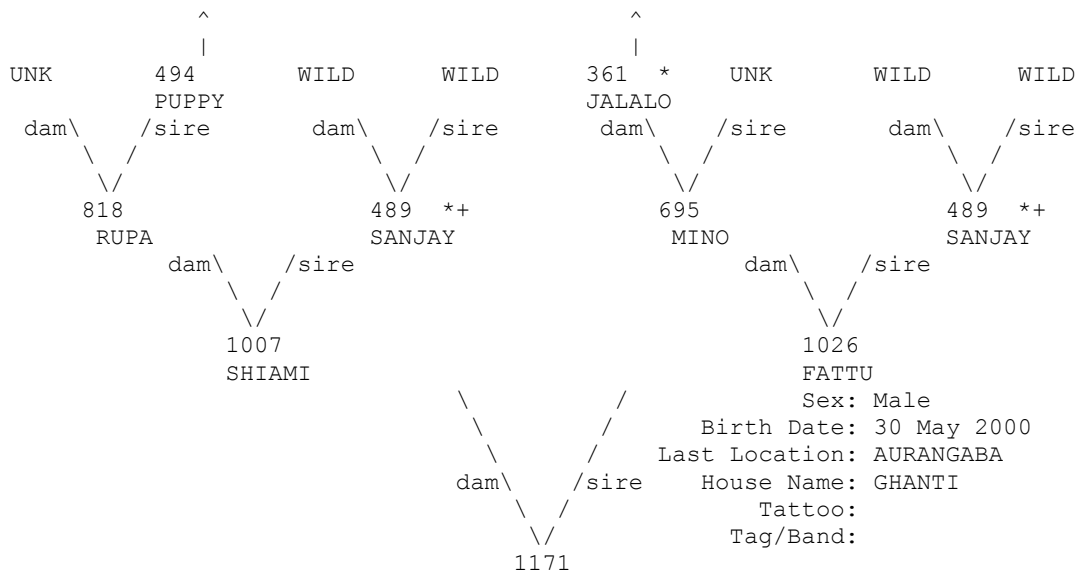

+ Wild-caught... * Appear more than once...
 ^ Pedigree continues beyond top of page...

=====
 Taxon Name: PANTHERA TIGRIS Studbook Number: 1172
 =====

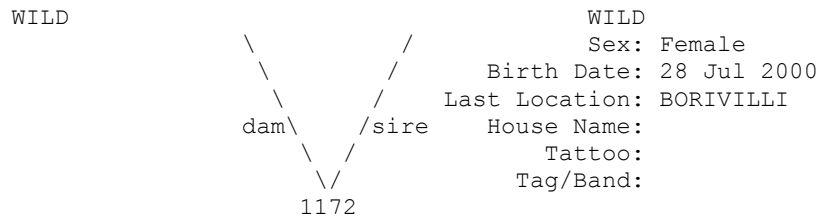

=====
 Taxon Name: PANTHERA TIGRIS Studbook Number: 1173
 =====

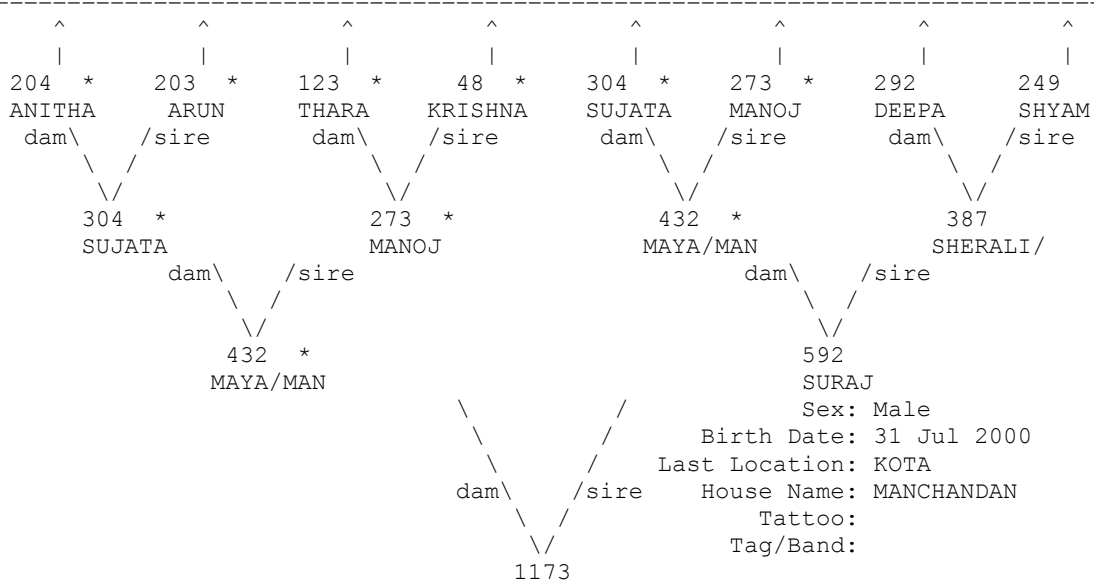

* Appear more than once...
 ^ Pedigree continues beyond top of page...

=====
 Taxon Name: PANTHERA TIGRIS Studbook Number: 1174
 =====

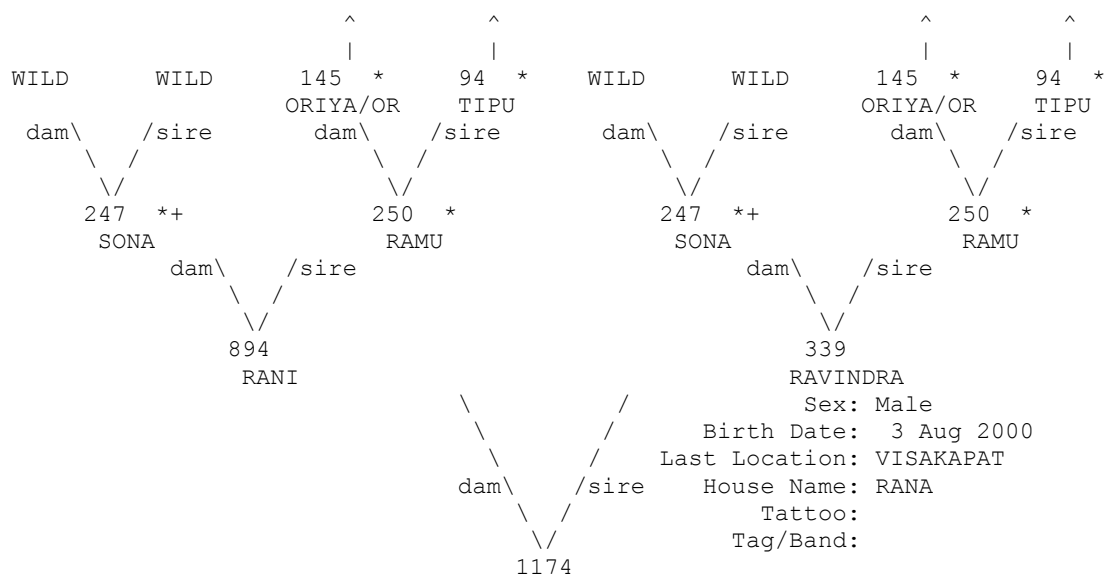

+ Wild-caught... * Appear more than once...
 ^ Pedigree continues beyond top of page...

=====
 Taxon Name: PANTHERA TIGRIS Studbook Number: 1175
 =====

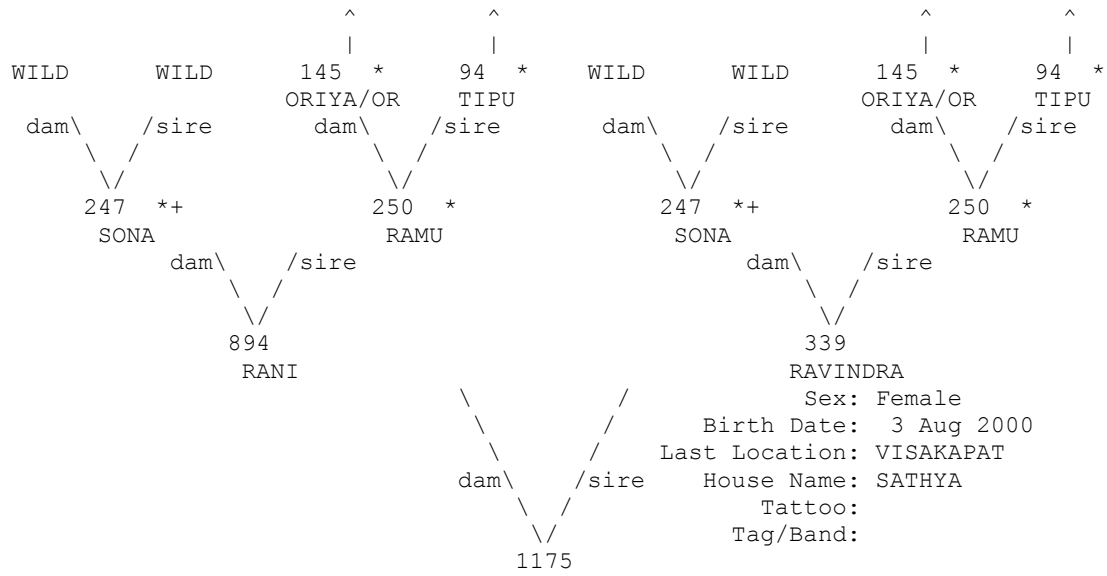

+ Wild-caught... * Appear more than once...
 ^ Pedigree continues beyond top of page...

=====
 Taxon Name: PANTHERA TIGRIS Studbook Number: 1176
 =====

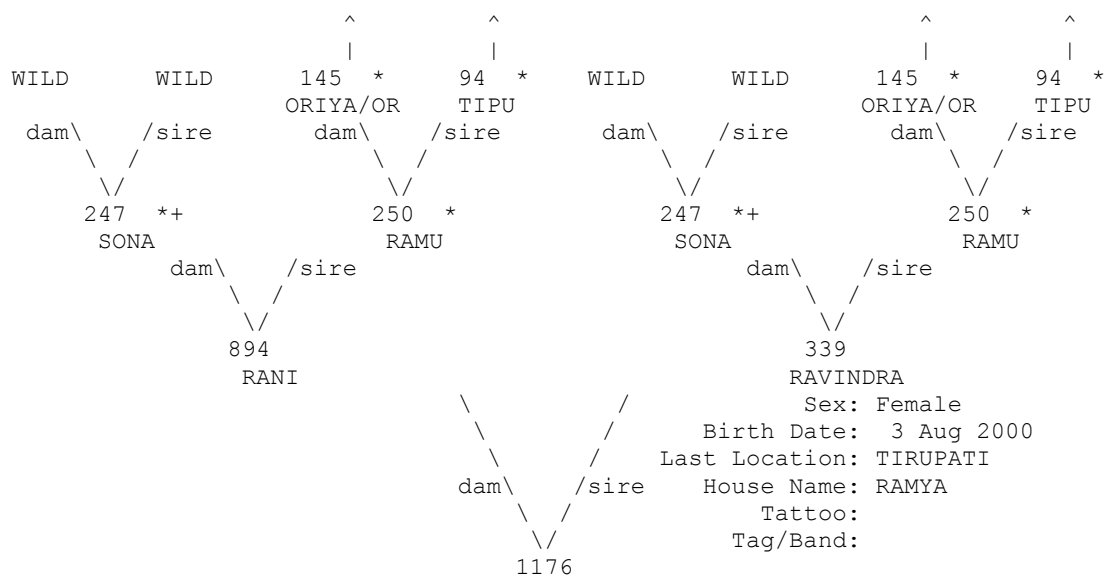

+ Wild-caught... * Appear more than once...
 ^ Pedigree continues beyond top of page...

=====
 Taxon Name: PANTHERA TIGRIS Studbook Number: 1177
 =====

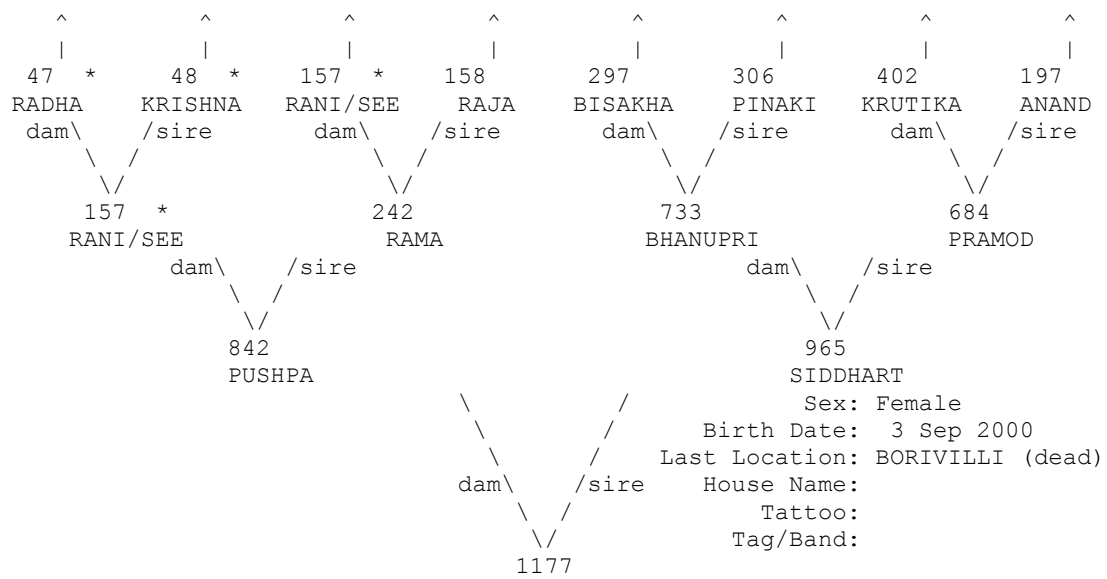

* Appear more than once...
 ^ Pedigree continues beyond top of page...

=====
 Taxon Name: PANTHERA TIGRIS Studbook Number: 1178
 =====

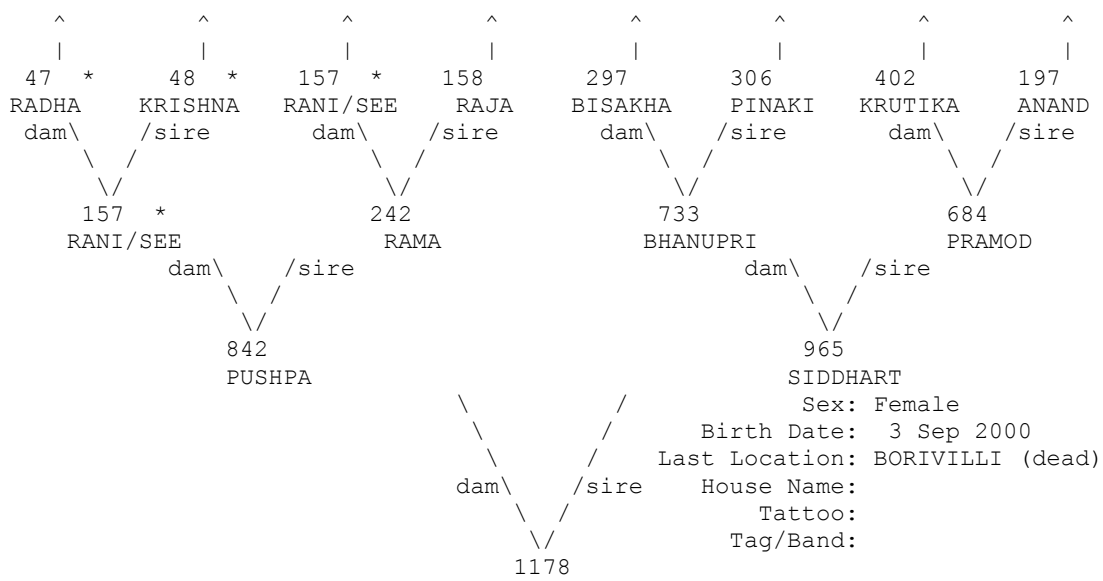

* Appear more than once...
 ^ Pedigree continues beyond top of page...

=====
 Taxon Name: PANTHERA TIGRIS Studbook Number: 1179
 =====

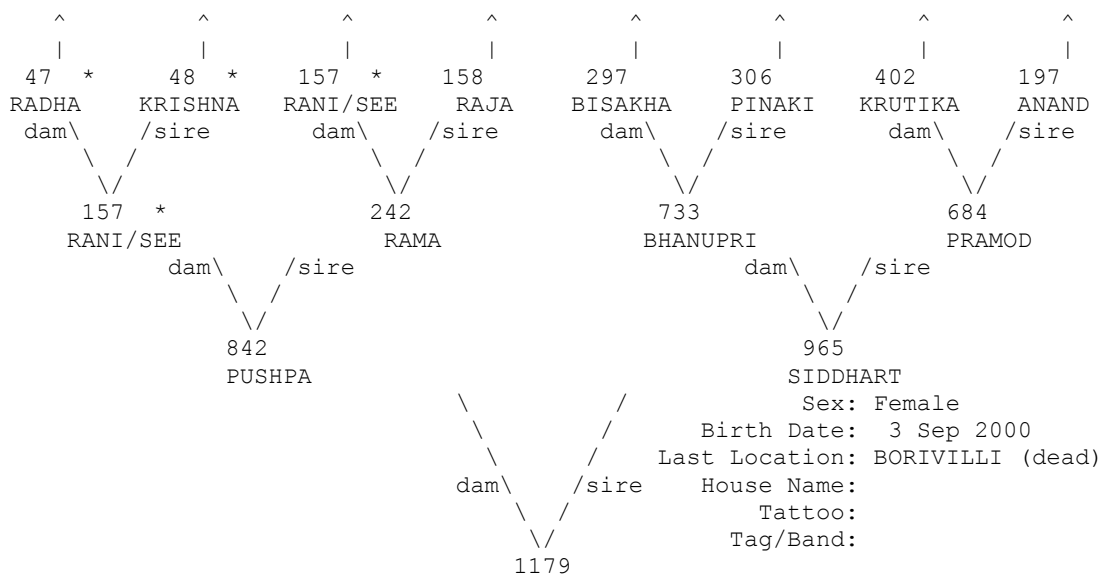

* Appear more than once...
 ^ Pedigree continues beyond top of page...

=====
 Taxon Name: PANTHERA TIGRIS Studbook Number: 1180
 =====

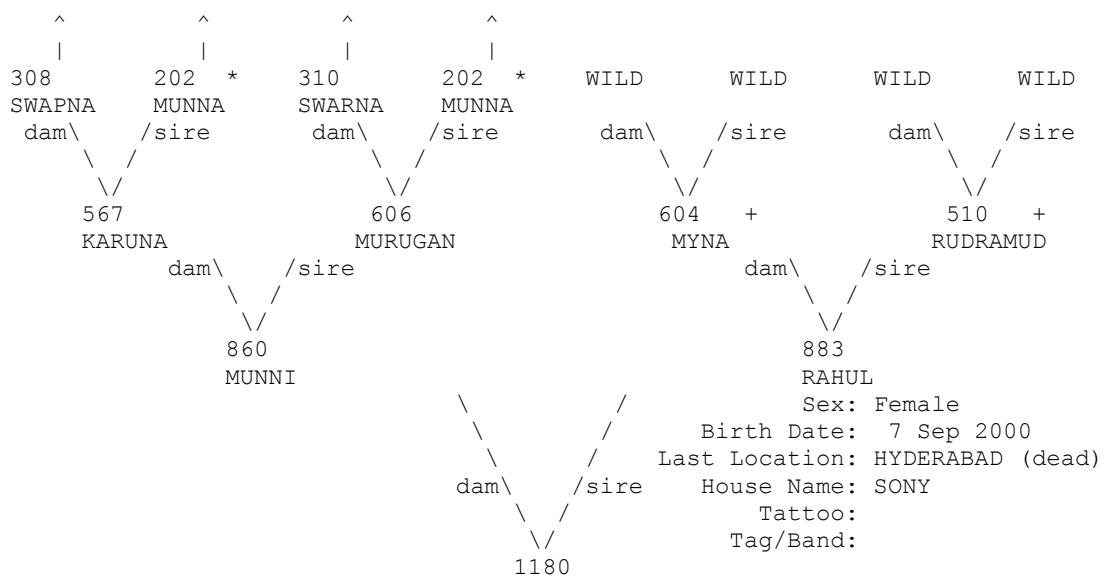

+ Wild-caught... * Appear more than once...
 ^ Pedigree continues beyond top of page...

=====
 Taxon Name: PANTHERA TIGRIS Studbook Number: 1181
 =====

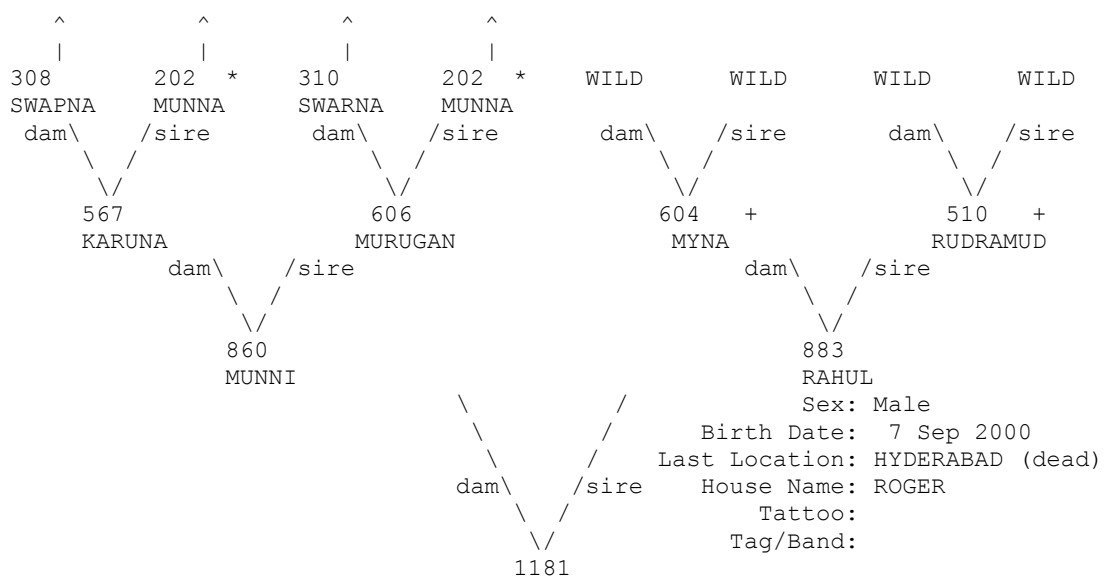

+ Wild-caught... * Appear more than once...
 ^ Pedigree continues beyond top of page...

=====
 Taxon Name: PANTHERA TIGRIS Studbook Number: 1184
 =====

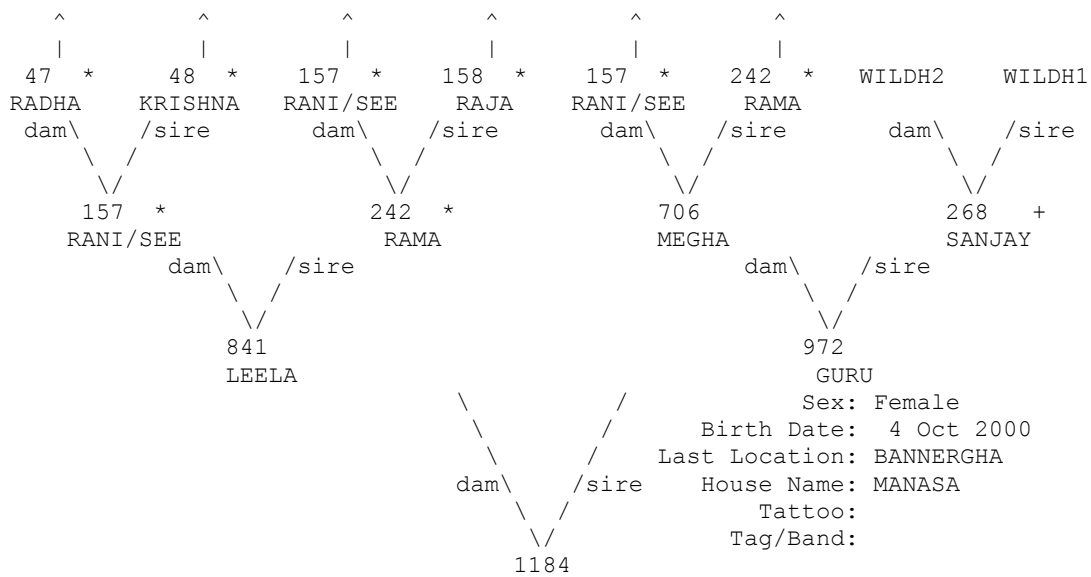

+ Wild-caught... * Appear more than once...
 ^ Pedigree continues beyond top of page...

=====
 Taxon Name: PANTHERA TIGRIS Studbook Number: 1185
 =====

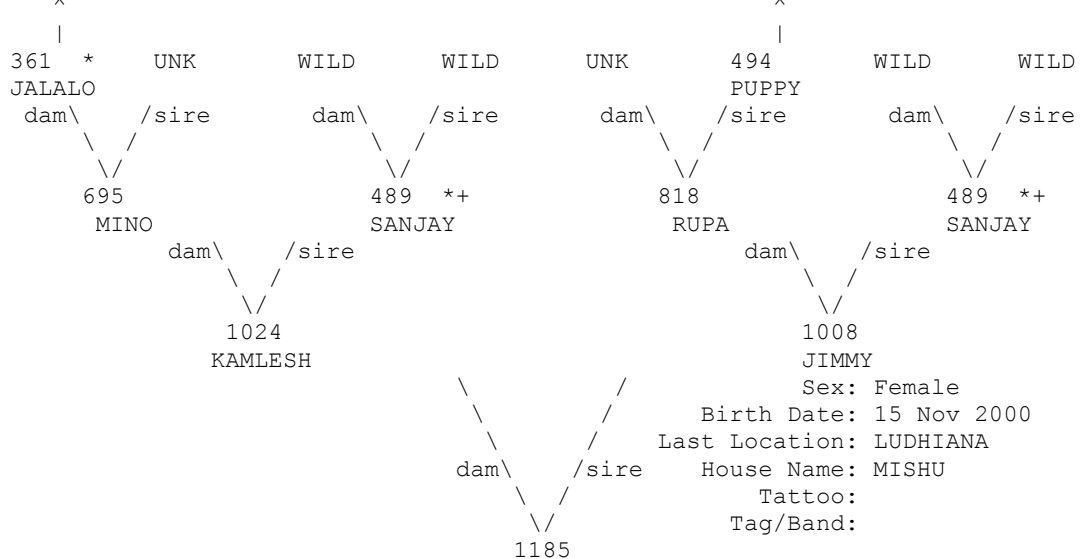

+ Wild-caught... * Appear more than once...
 ^ Pedigree continues beyond top of page...

=====
 Taxon Name: PANTHERA TIGRIS Studbook Number: 1186
 =====

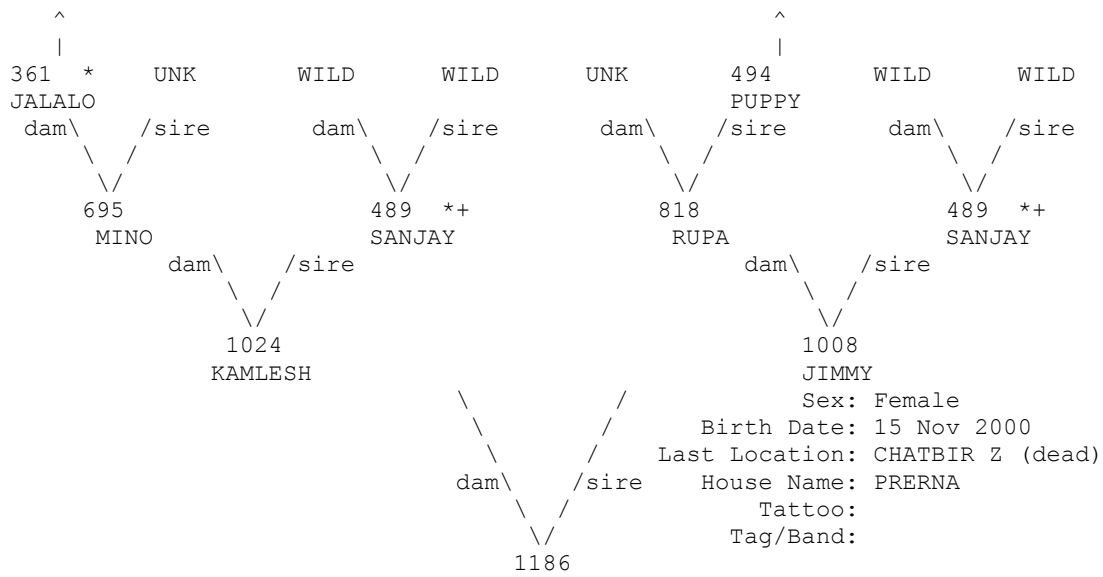

+ Wild-caught... * Appear more than once...
 ^ Pedigree continues beyond top of page...

=====
 Taxon Name: PANTHERA TIGRIS Studbook Number: 1187
 =====

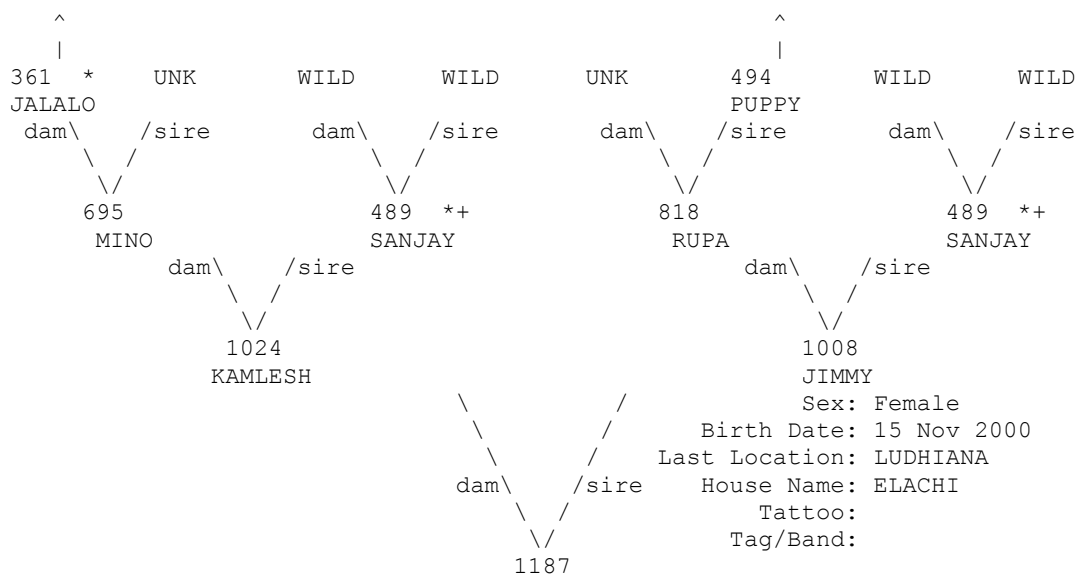

+ Wild-caught... * Appear more than once...
 ^ Pedigree continues beyond top of page...

=====
 Taxon Name: PANTHERA TIGRIS Studbook Number: 1188
 =====

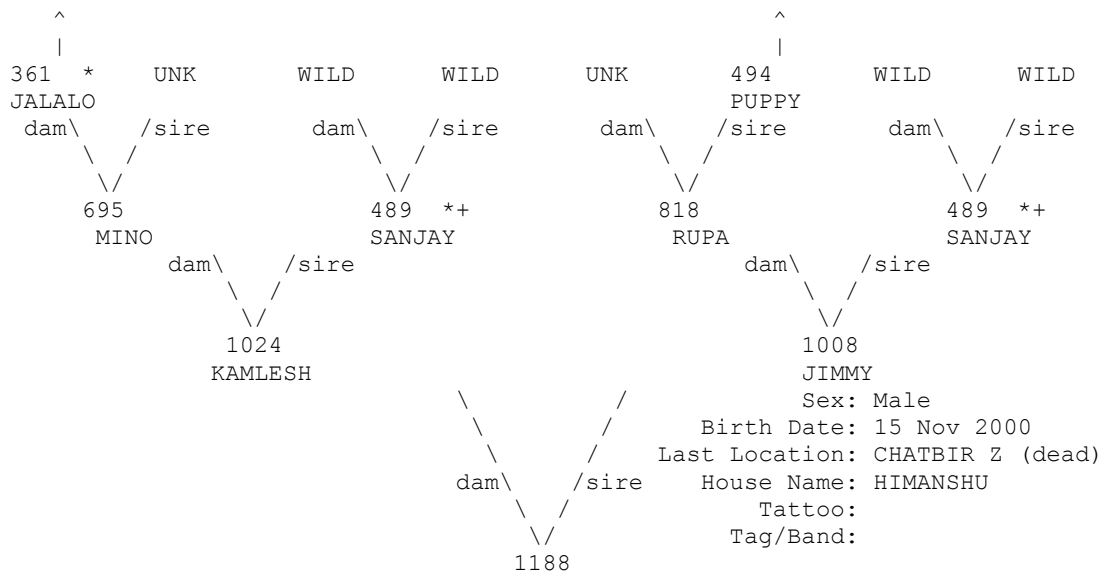

+ Wild-caught... * Appear more than once...
 ^ Pedigree continues beyond top of page...

=====
 Taxon Name: PANTHERA TIGRIS Studbook Number: 1190
 =====

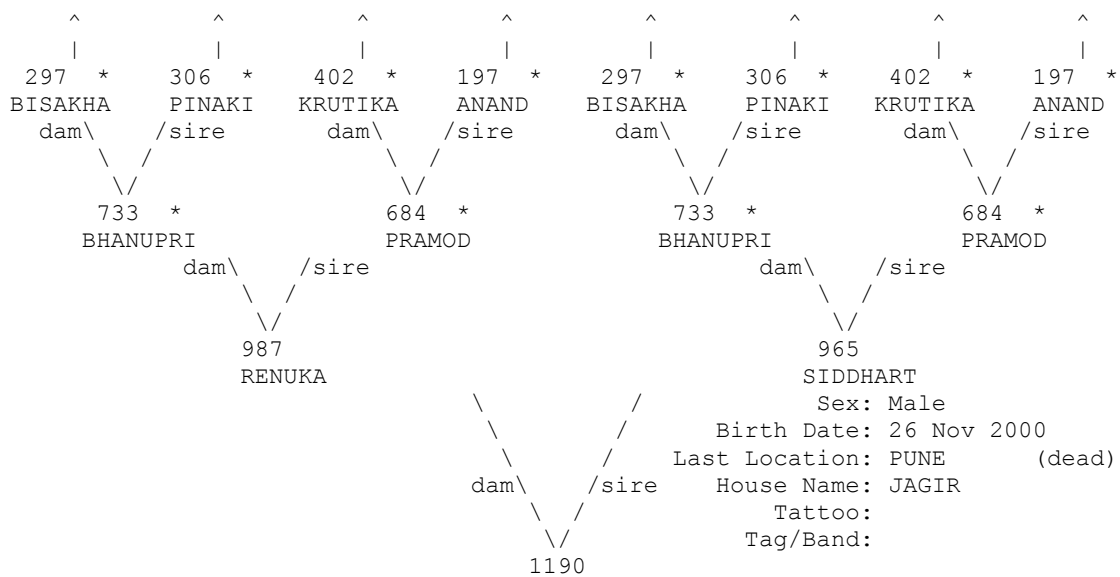

* Appear more than once...
 ^ Pedigree continues beyond top of page...

=====
 Taxon Name: PANTHERA TIGRIS Studbook Number: 1191
 =====

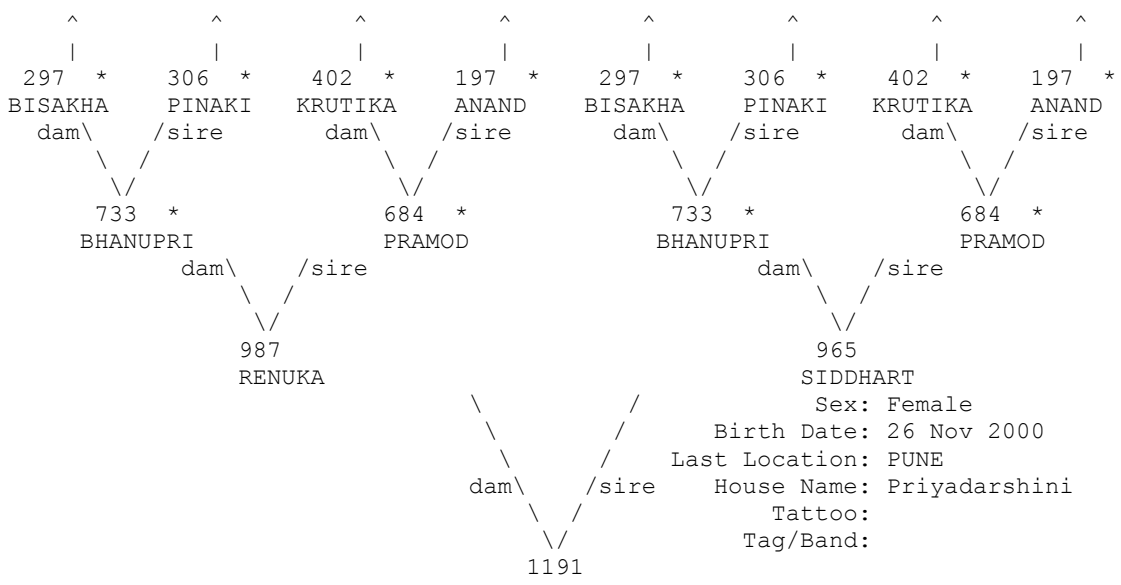

* Appear more than once...
 ^ Pedigree continues beyond top of page...

=====
 Taxon Name: PANTHERA TIGRIS Studbook Number: 1192
 =====

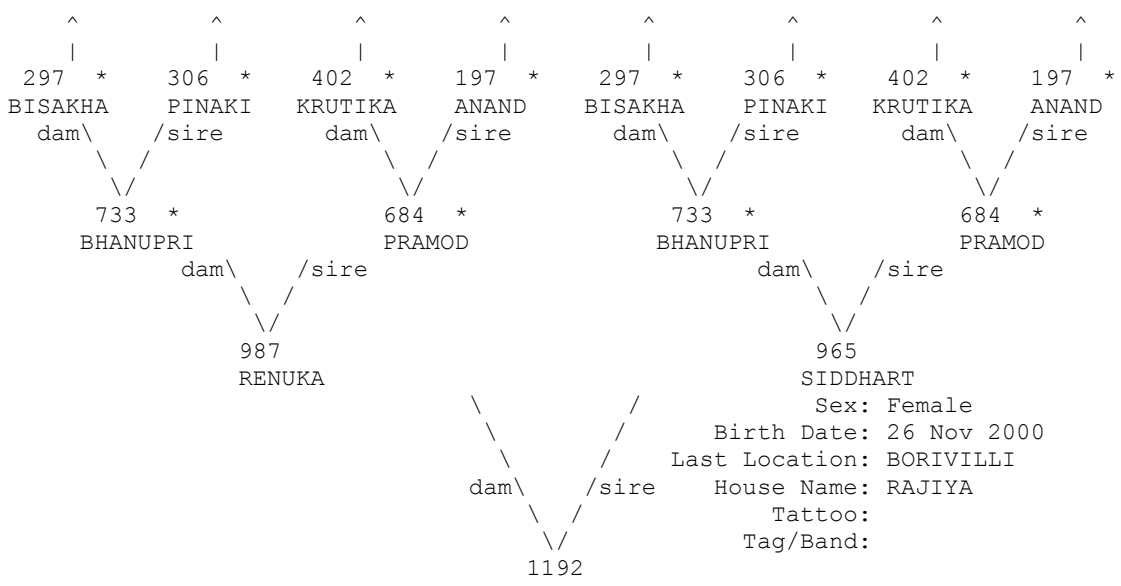

* Appear more than once...
 ^ Pedigree continues beyond top of page...

=====
 Taxon Name: PANTHERA TIGRIS Studbook Number: 1193
 =====

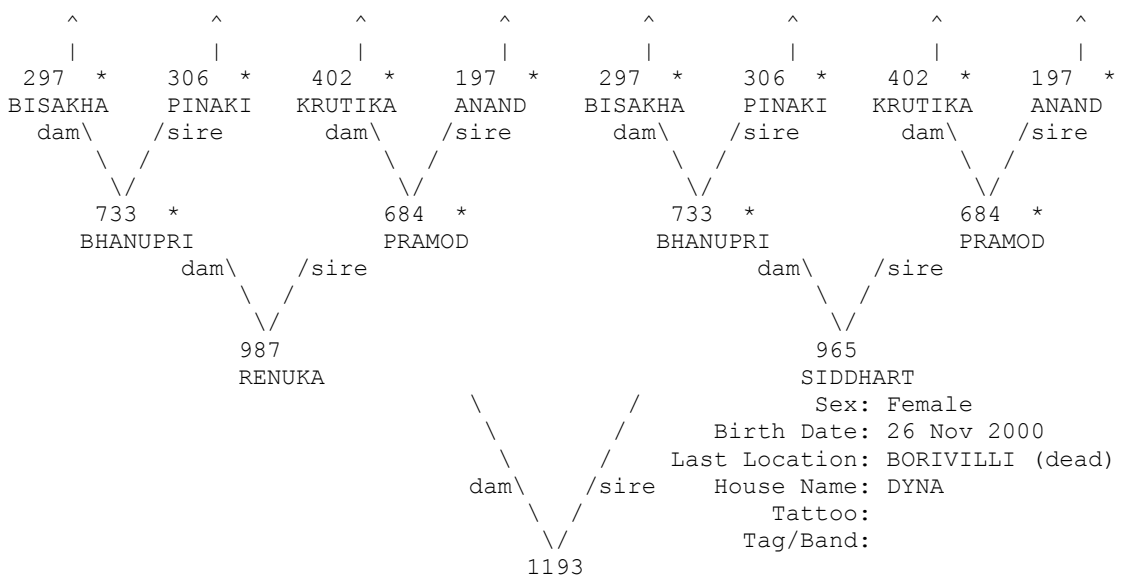

* Appear more than once...
 ^ Pedigree continues beyond top of page...

=====
 Taxon Name: PANTHERA TIGRIS Studbook Number: 1194
 =====

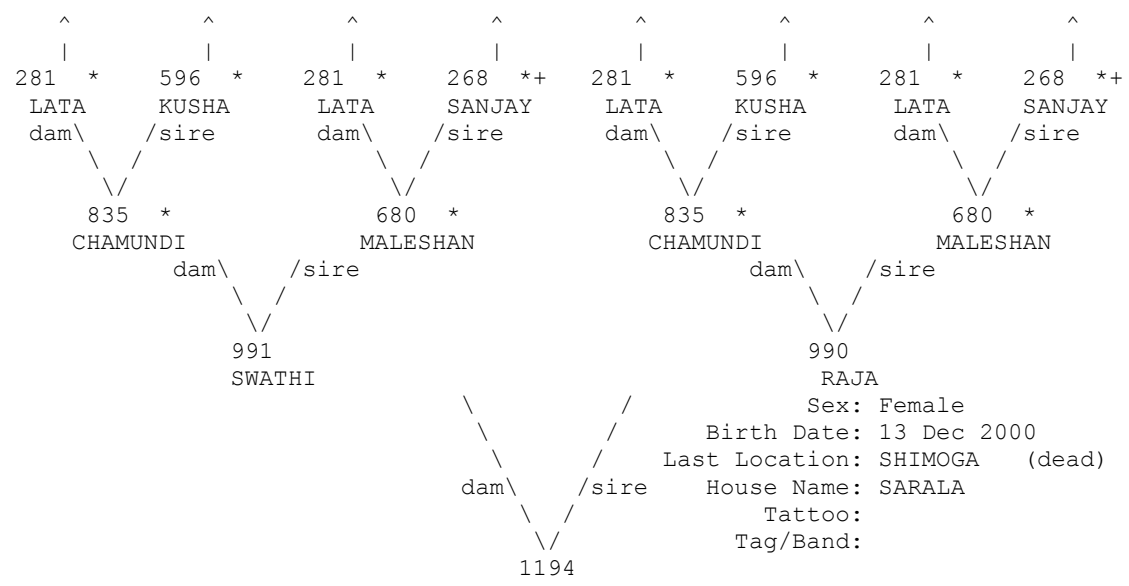

+ Wild-caught... * Appear more than once...
 ^ Pedigree continues beyond top of page...

=====

Taxon Name: PANTHERA TIGRIS Studbook Number: 1195

=====

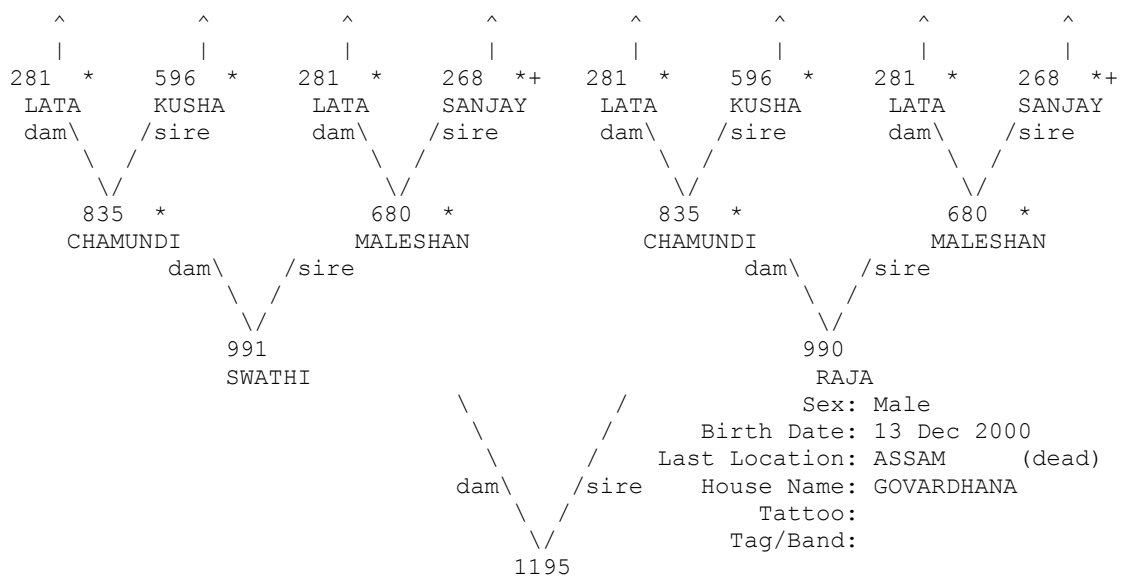

+ Wild-caught... * Appear more than once...
 ^ Pedigree continues beyond top of page...

=====

Taxon Name: PANTHERA TIGRIS Studbook Number: 1196

=====

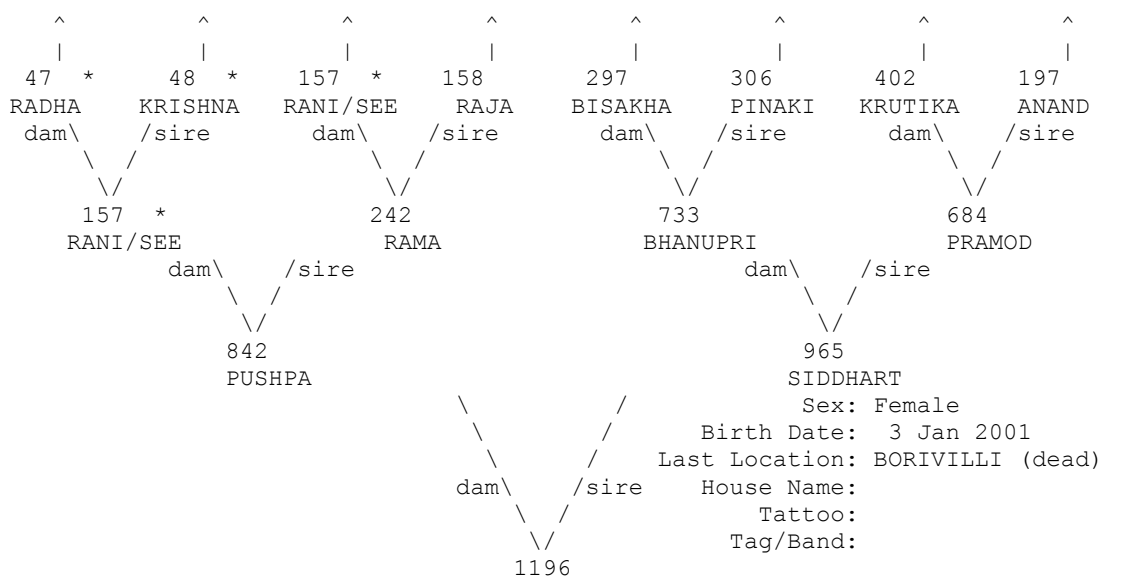

* Appear more than once...
 ^ Pedigree continues beyond top of page...

=====
 Taxon Name: PANTHERA TIGRIS Studbook Number: 1197
 =====

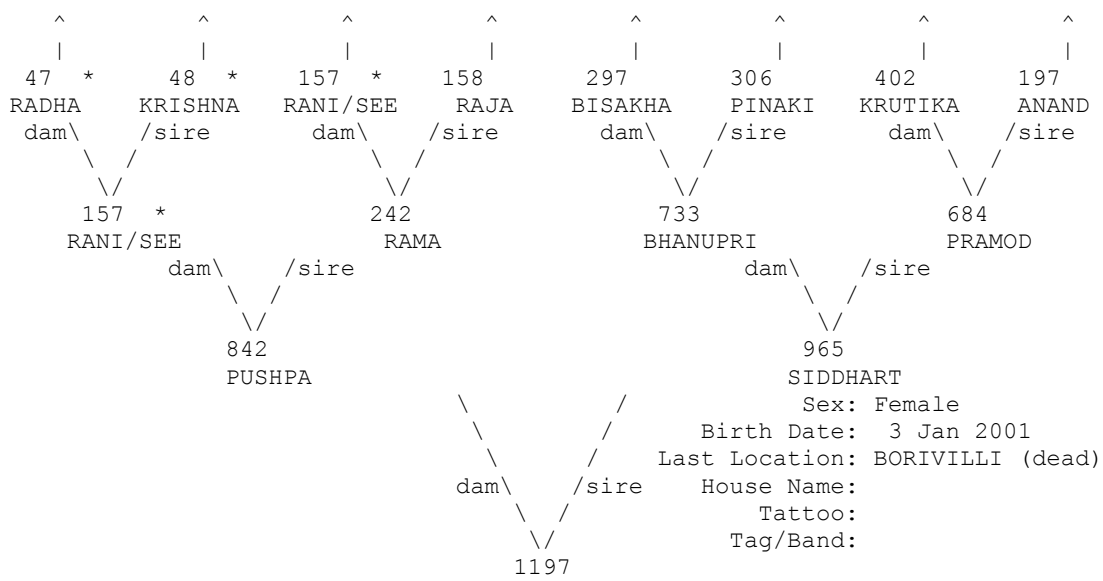

* Appear more than once...
 ^ Pedigree continues beyond top of page...

=====
 Taxon Name: PANTHERA TIGRIS Studbook Number: 1198
 =====

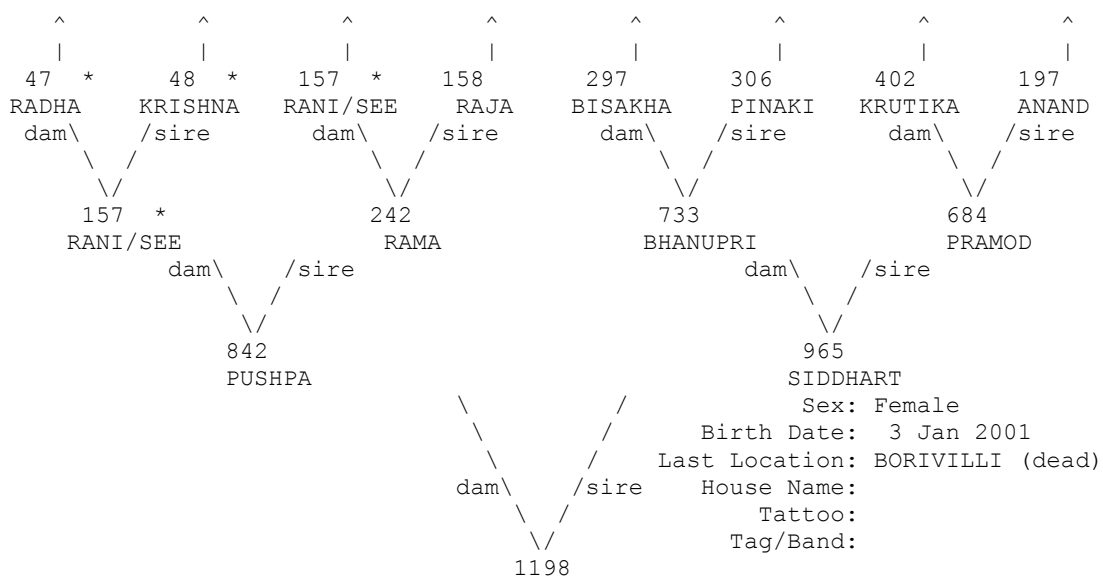

* Appear more than once...
 ^ Pedigree continues beyond top of page...

=====
 Taxon Name: PANTHERA TIGRIS Studbook Number: 1199
 =====

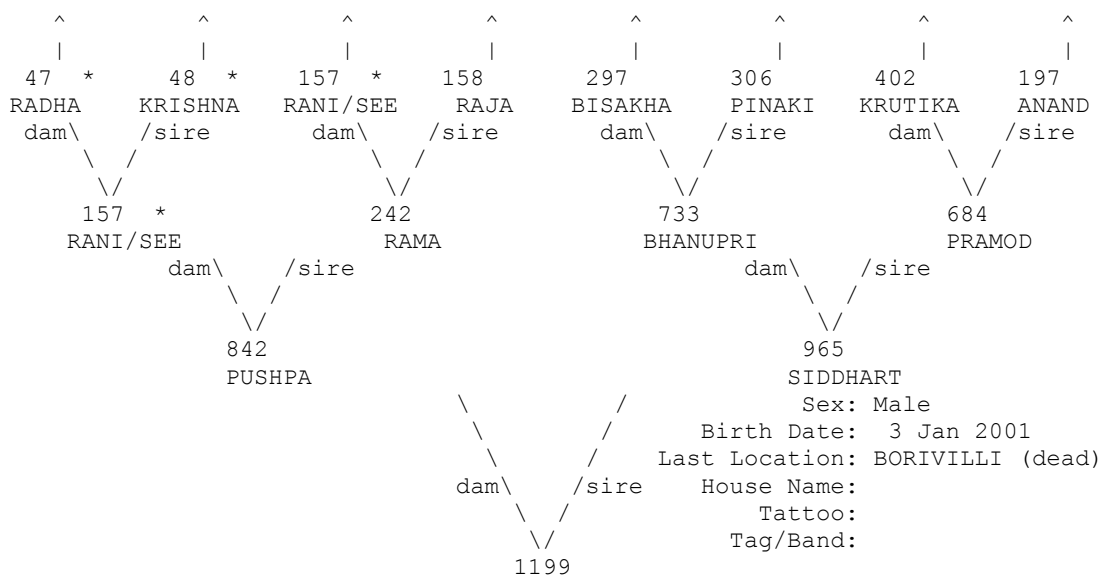

* Appear more than once...
 ^ Pedigree continues beyond top of page...

=====
 Taxon Name: PANTHERA TIGRIS Studbook Number: 1200
 =====

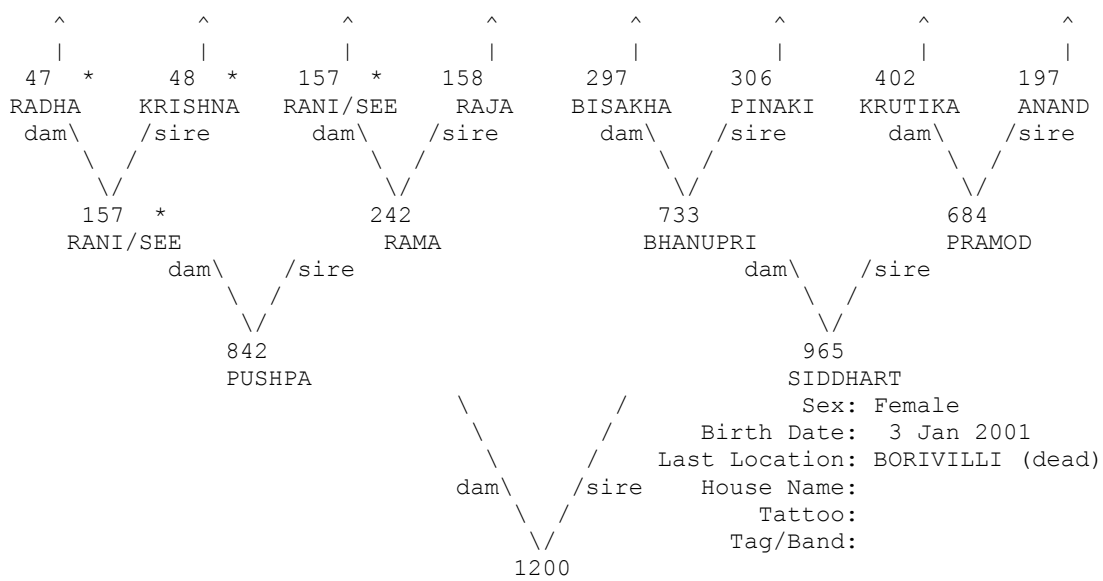

* Appear more than once...
 ^ Pedigree continues beyond top of page...

=====
 Taxon Name: PANTHERA TIGRIS Studbook Number: 1201
 =====

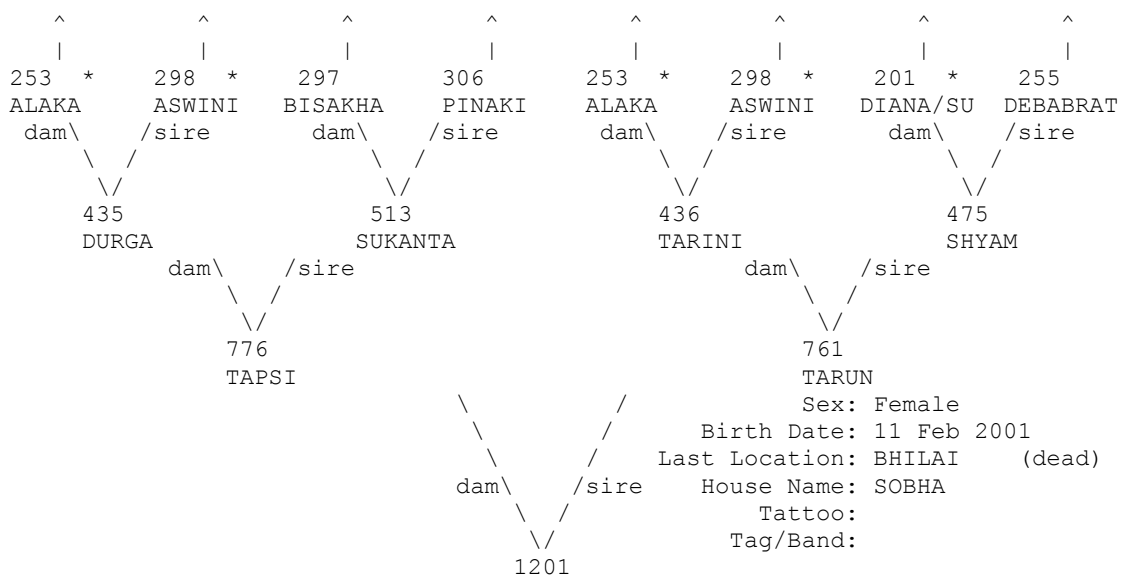

* Appear more than once...
 ^ Pedigree continues beyond top of page...

=====
 Taxon Name: PANTHERA TIGRIS Studbook Number: 1202
 =====

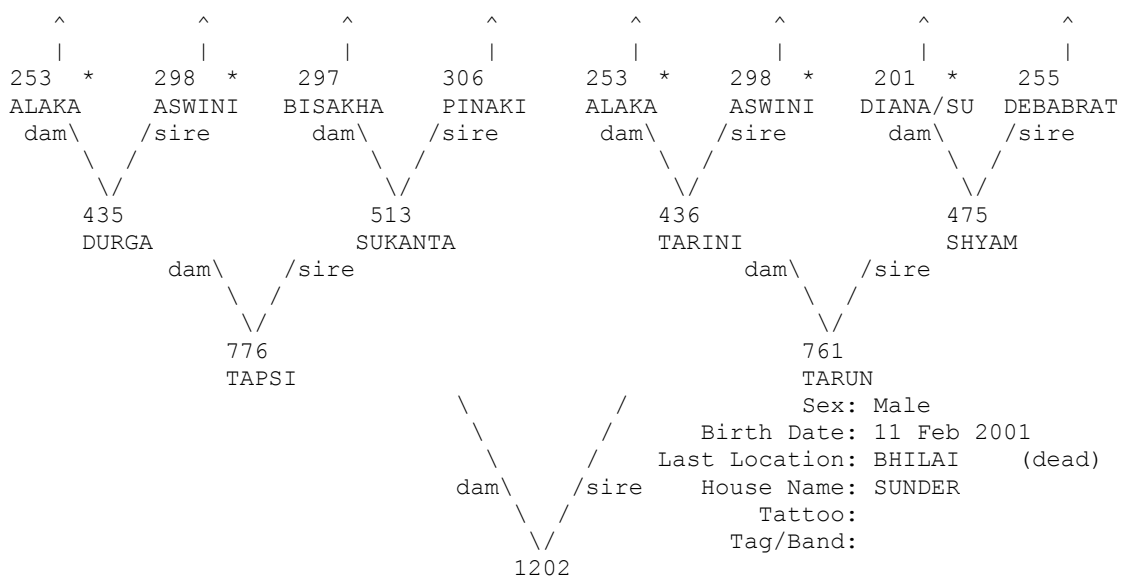

* Appear more than once...
 ^ Pedigree continues beyond top of page...

=====
 Taxon Name: PANTHERA TIGRIS Studbook Number: 1203
 =====

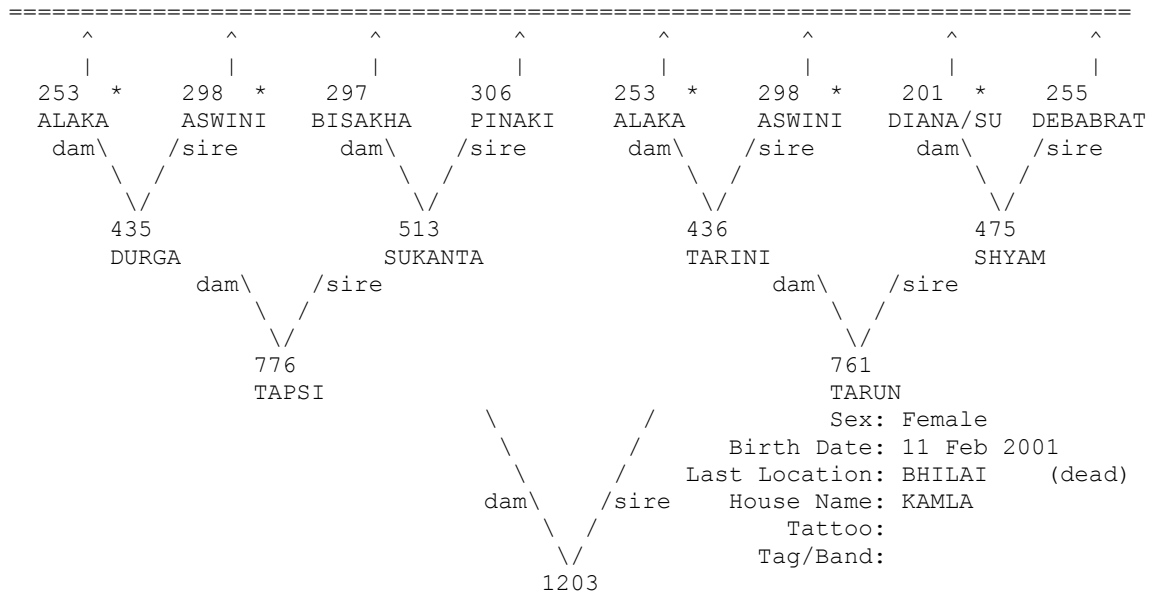

* Appear more than once...
^ Pedigree continues beyond top of page...

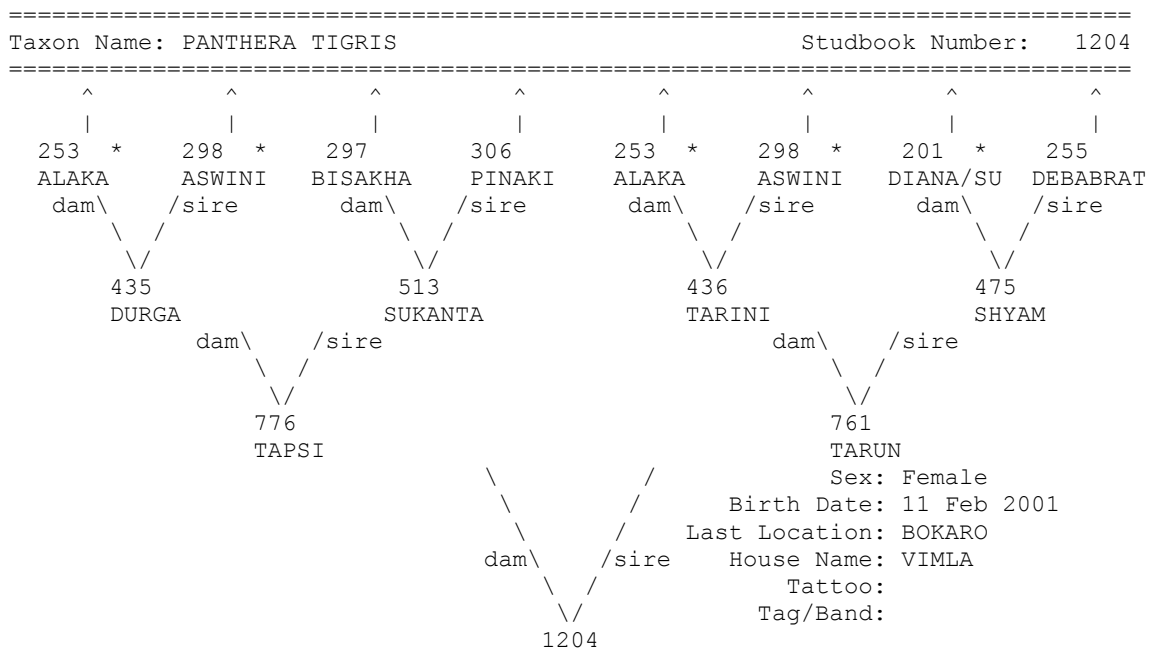

* Appear more than once...
^ Pedigree continues beyond top of page...

=====
 Taxon Name: PANTHERA TIGRIS Studbook Number: 1205
 =====

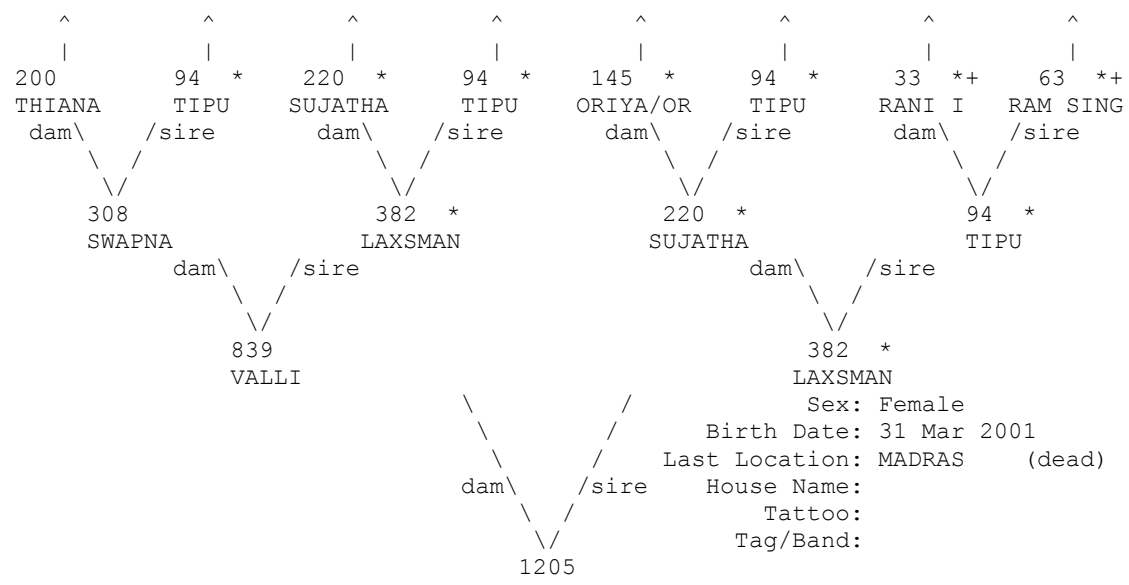

+ Wild-caught... * Appear more than once...
 ^ Pedigree continues beyond top of page...

=====
 Taxon Name: PANTHERA TIGRIS Studbook Number: 1206
 =====

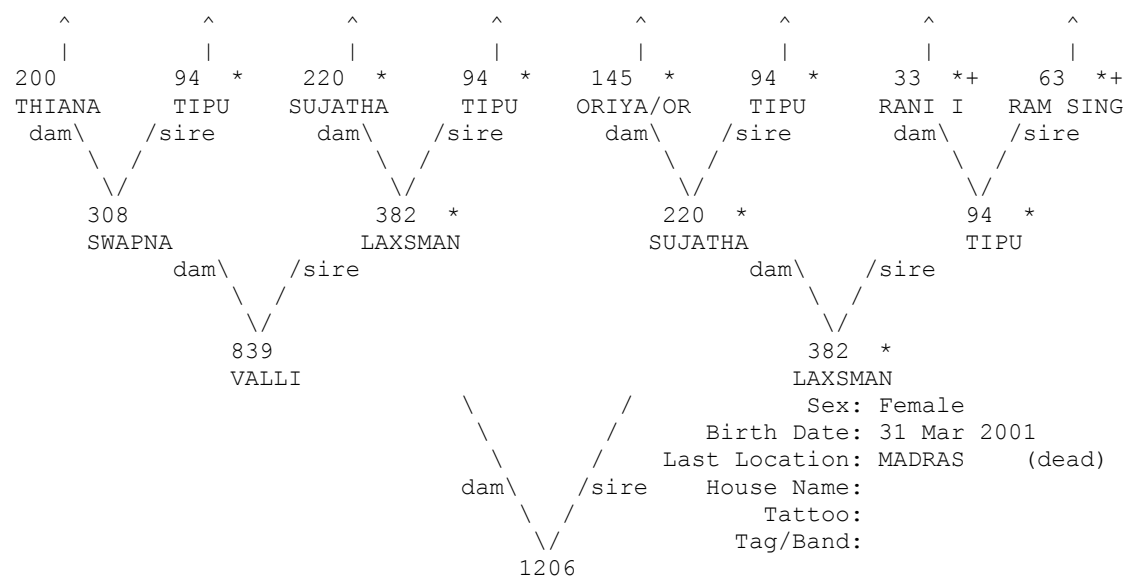

+ Wild-caught... * Appear more than once...
 ^ Pedigree continues beyond top of page...

=====
 Taxon Name: PANTHERA TIGRIS Studbook Number: 1207
 =====

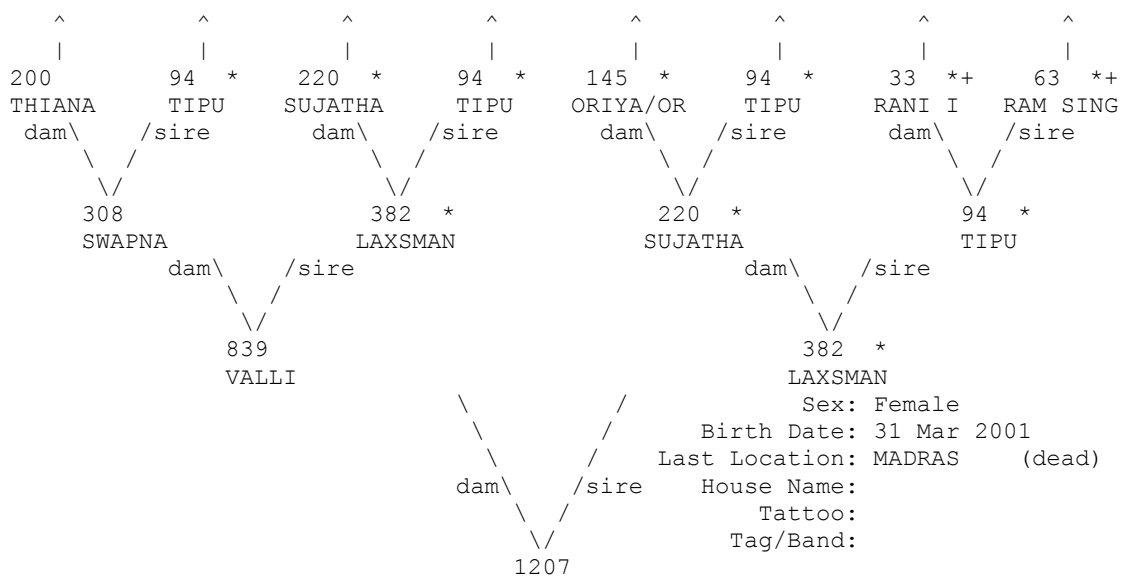

+ Wild-caught... * Appear more than once...
 ^ Pedigree continues beyond top of page...

=====
 Taxon Name: PANTHERA TIGRIS Studbook Number: 1208
 =====

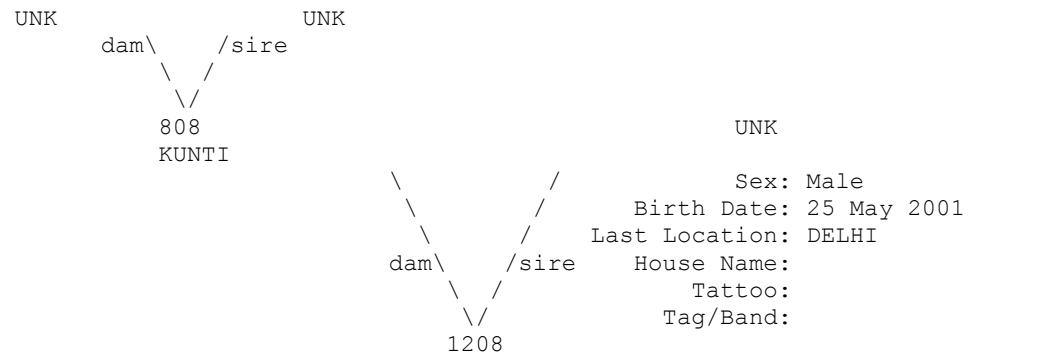

=====
 Taxon Name: PANTHERA TIGRIS Studbook Number: 1209
 =====

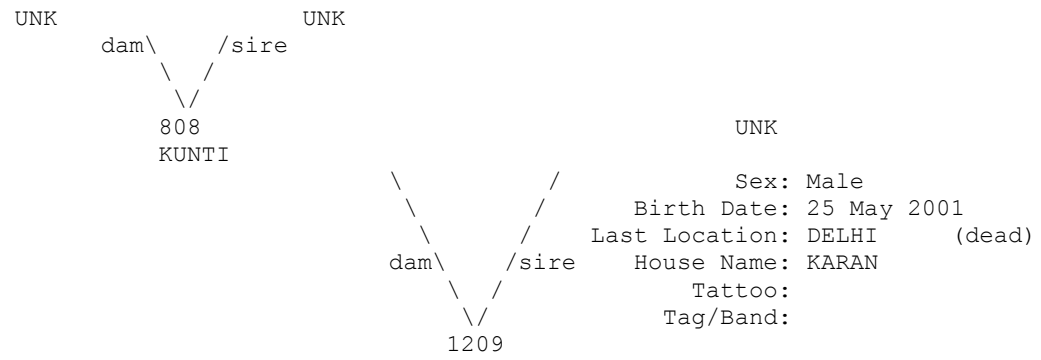

=====
 Taxon Name: PANTHERA TIGRIS Studbook Number: 1215
 =====

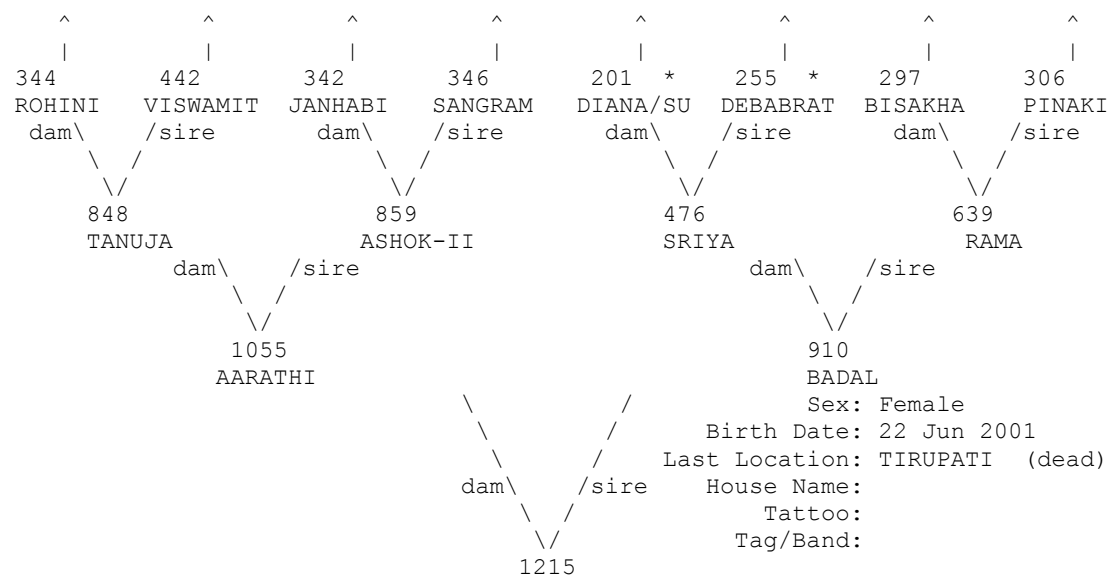

Sex: Female
 Birth Date: 22 Jun 2001
 Last Location: TIRUPATI (dead)
 House Name:
 Tattoo:
 Tag/Band:

* Appear more than once...
 ^ Pedigree continues beyond top of page...

=====
 Taxon Name: PANTHERA TIGRIS Studbook Number: 1216
 =====

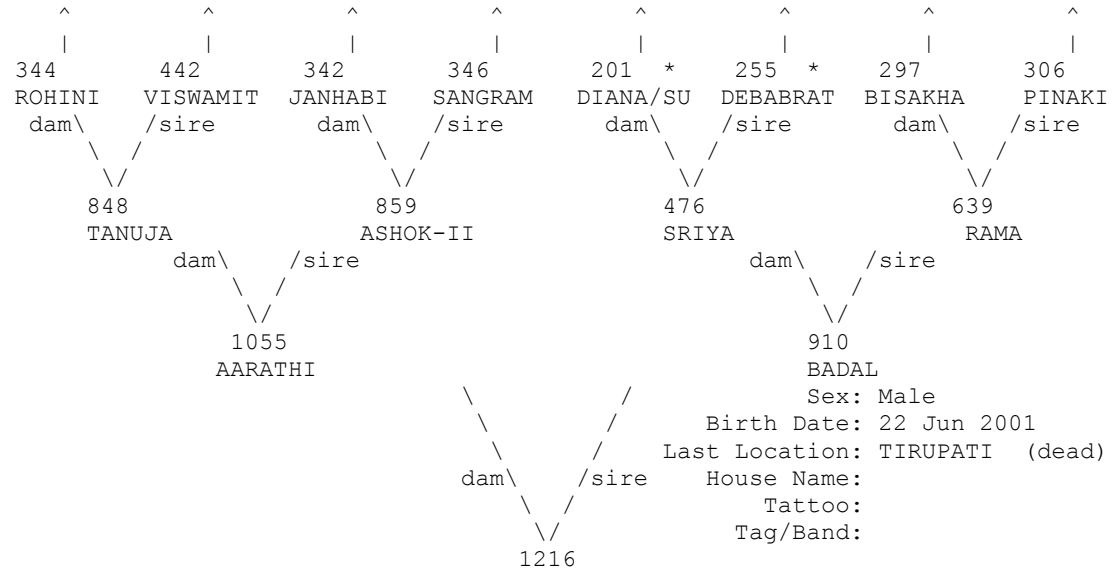

Sex: Male
 Birth Date: 22 Jun 2001
 Last Location: TIRUPATI (dead)
 House Name:
 Tattoo:
 Tag/Band:

* Appear more than once...
 ^ Pedigree continues beyond top of page...

=====
 Taxon Name: PANTHERA TIGRIS Studbook Number: 1217
 =====

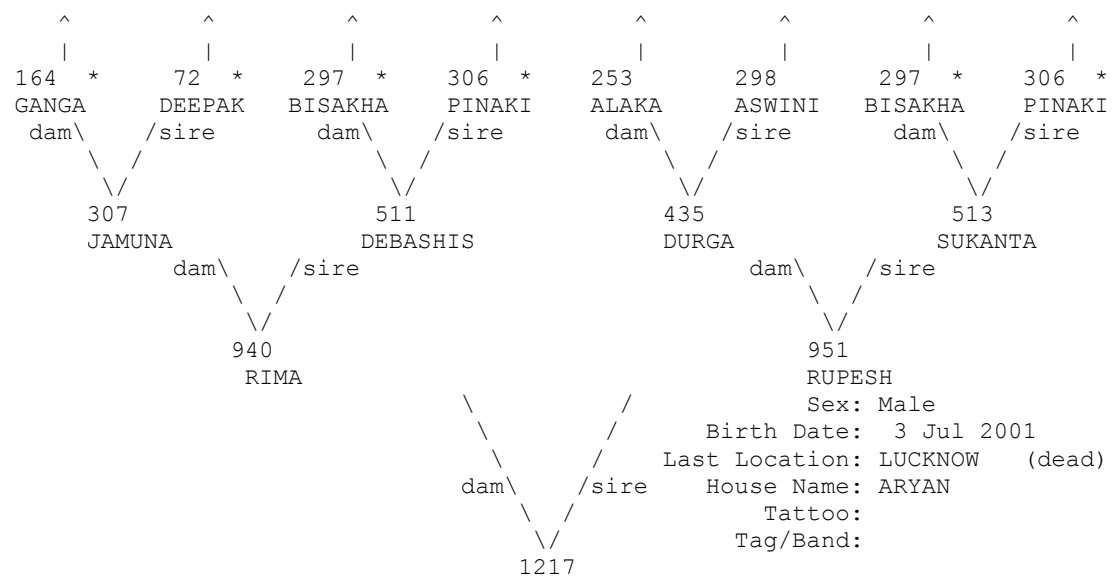

* Appear more than once...
 ^ Pedigree continues beyond top of page...

=====
 Taxon Name: PANTHERA TIGRIS Studbook Number: 1218
 =====

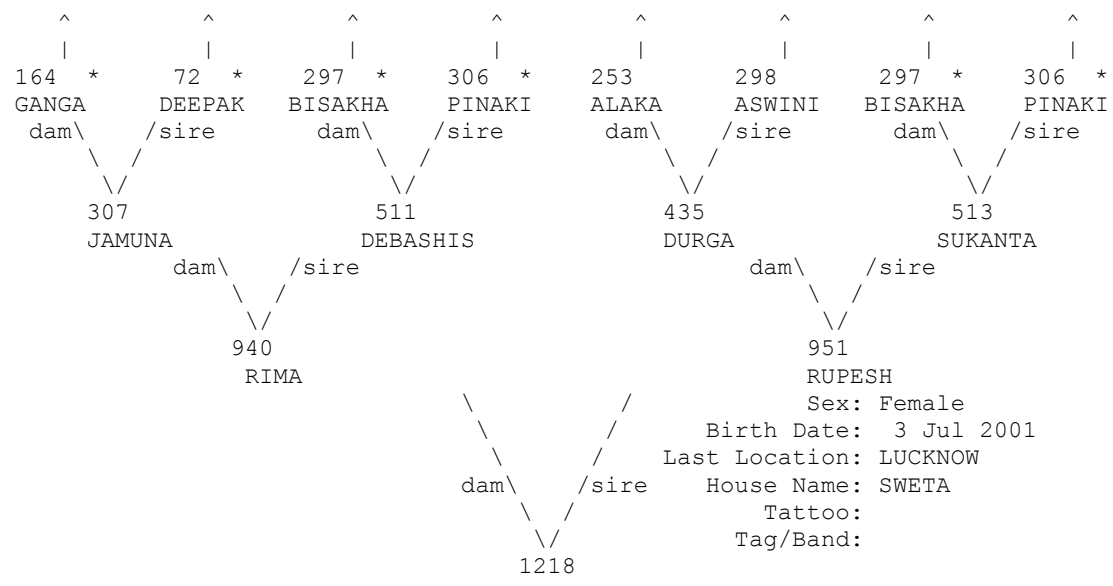

* Appear more than once...
 ^ Pedigree continues beyond top of page...

=====
 Taxon Name: PANTHERA TIGRIS Studbook Number: 1219
 =====

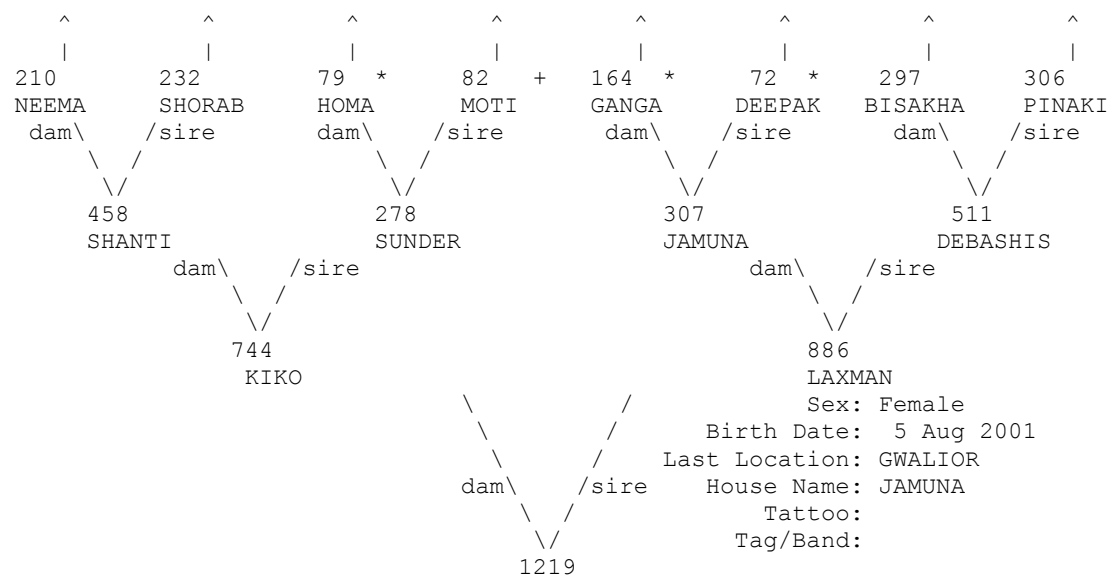

+ Wild-caught... * Appear more than once...
 ^ Pedigree continues beyond top of page...

=====
 Taxon Name: PANTHERA TIGRIS Studbook Number: 1220
 =====

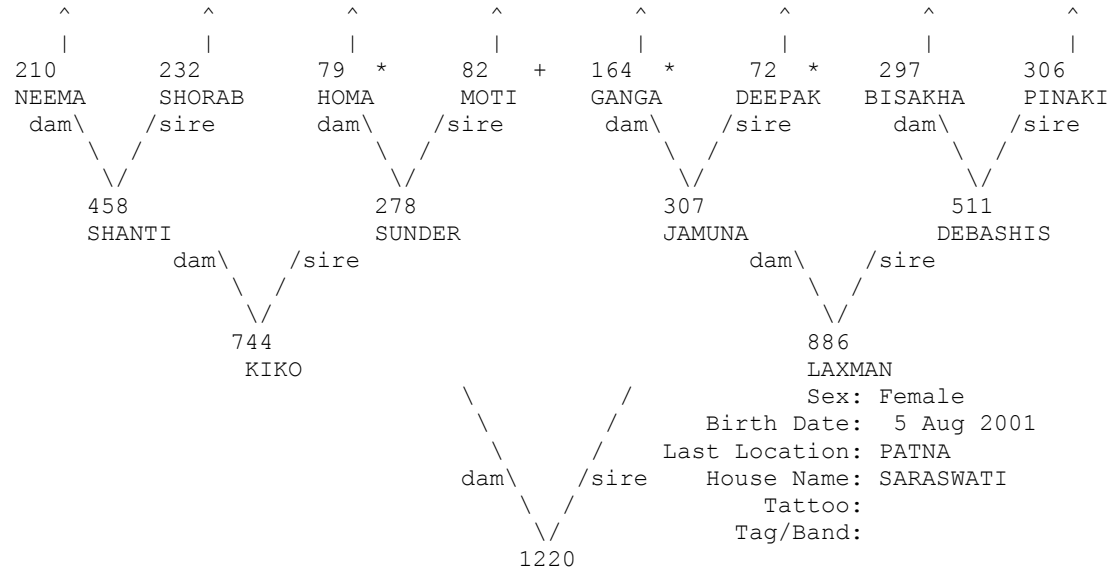

+ Wild-caught... * Appear more than once...
 ^ Pedigree continues beyond top of page...

=====
 Taxon Name: PANTHERA TIGRIS Studbook Number: 1221
 =====

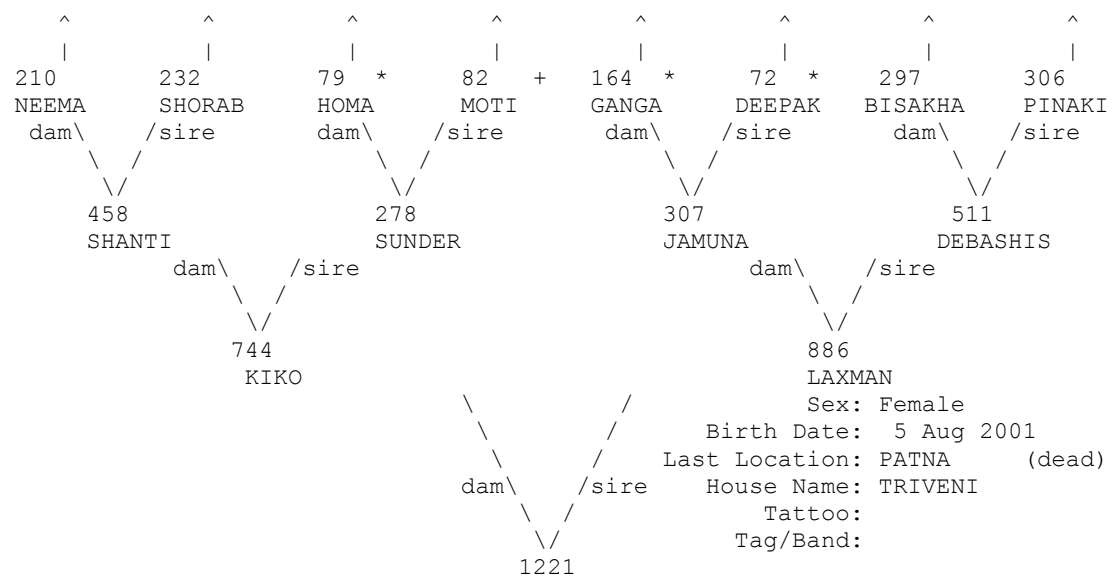

+ Wild-caught... * Appear more than once...
 ^ Pedigree continues beyond top of page...

=====
 Taxon Name: PANTHERA TIGRIS Studbook Number: 1222
 =====

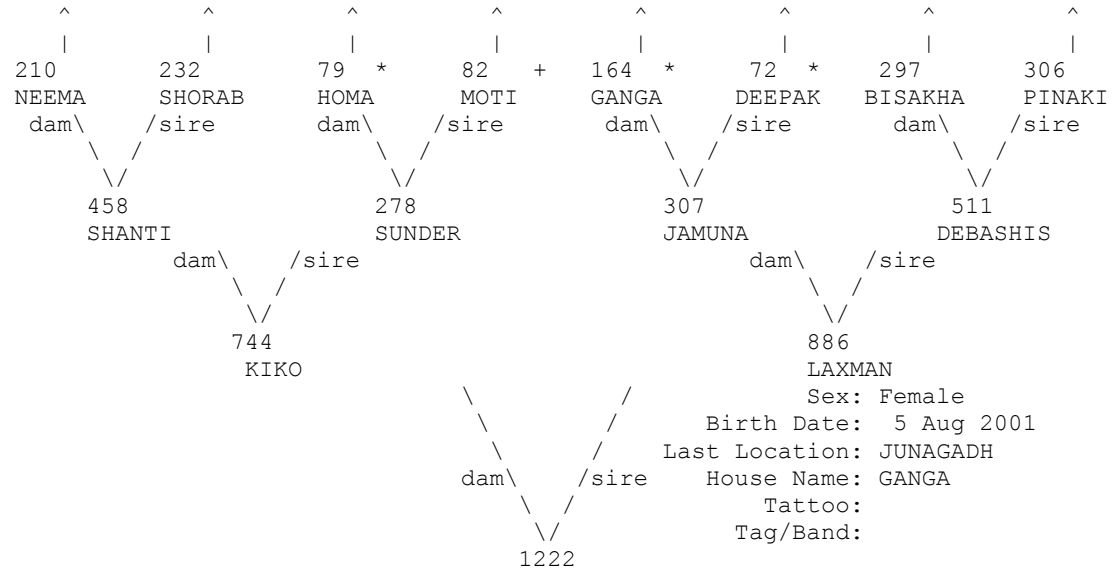

+ Wild-caught... * Appear more than once...
 ^ Pedigree continues beyond top of page...

=====
 Taxon Name: PANTHERA TIGRIS Studbook Number: 1228
 =====

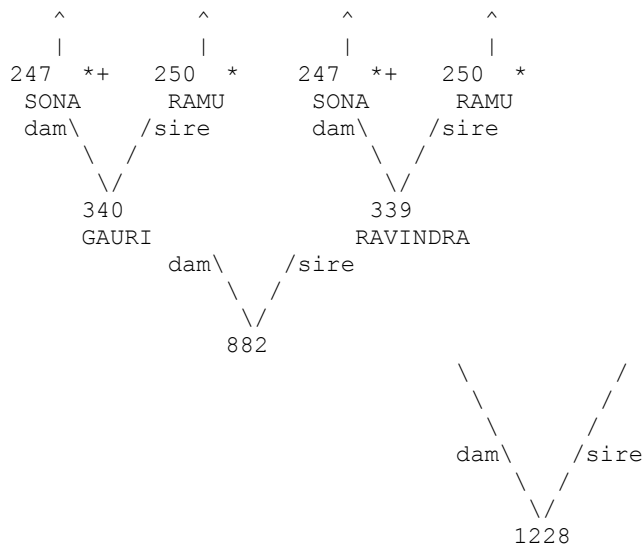

UNK
 Sex: Female
 Birth Date: 2 Nov 2001
 Last Location: VISAKAPAT
 House Name: JANAKI
 Tattoo:
 Tag/Band:

+ Wild-caught... * Appear more than once...
 ^ Pedigree continues beyond top of page...

=====
 Taxon Name: PANTHERA TIGRIS Studbook Number: 1229
 =====

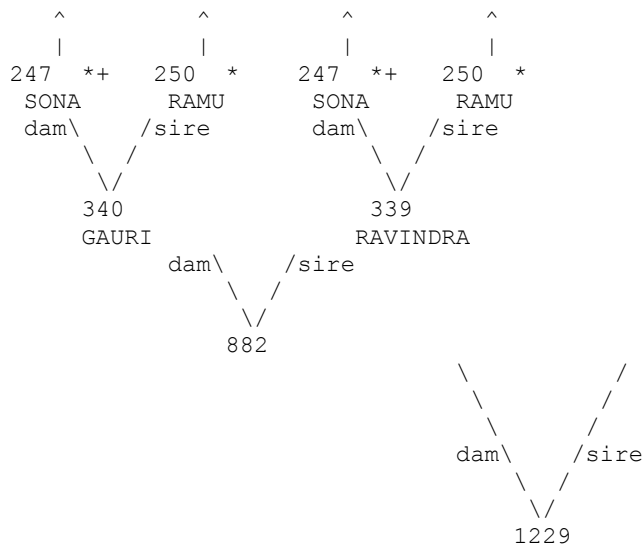

UNK
 Sex: Female
 Birth Date: 2 Nov 2001
 Last Location: VISAKAPAT
 House Name: RAJANI
 Tattoo:
 Tag/Band:

+ Wild-caught... * Appear more than once...
 ^ Pedigree continues beyond top of page...

=====
 Taxon Name: PANTHERA TIGRIS Studbook Number: 1230
 =====

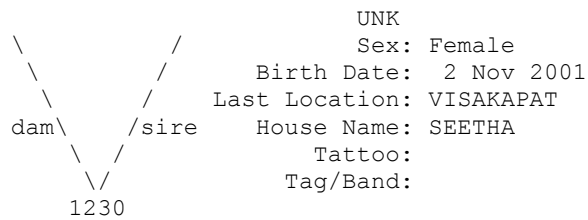
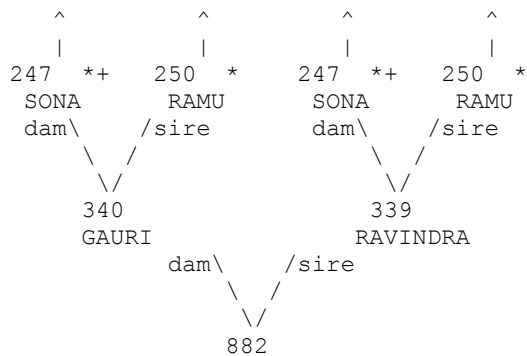

+ Wild-caught... * Appear more than once...
 ^ Pedigree continues beyond top of page...

=====
 Taxon Name: PANTHERA TIGRIS Studbook Number: 1231
 =====

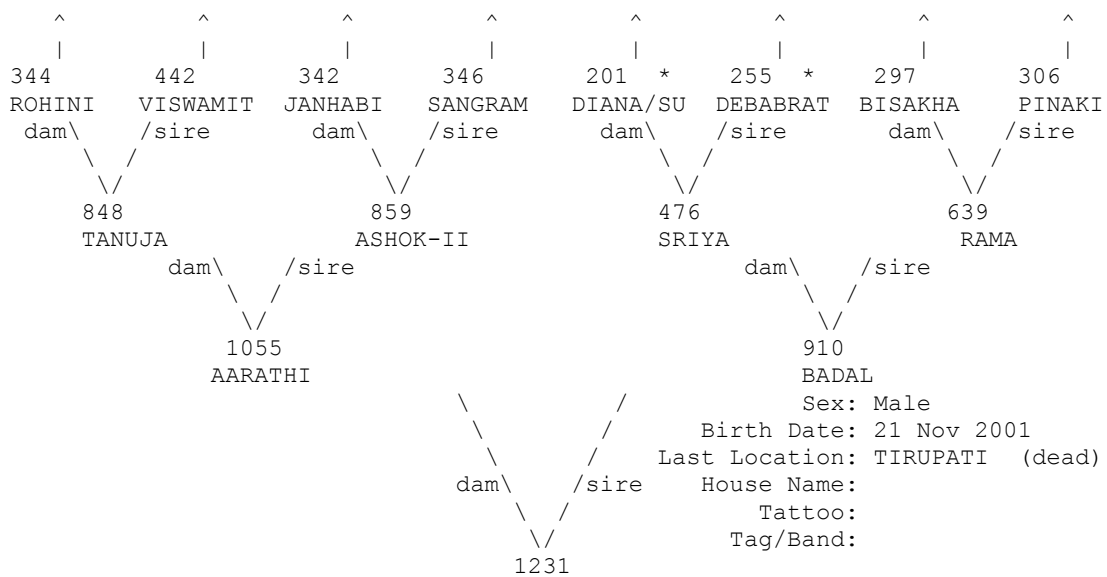

* Appear more than once...
 ^ Pedigree continues beyond top of page...

=====
 Taxon Name: PANTHERA TIGRIS Studbook Number: 1232
 =====

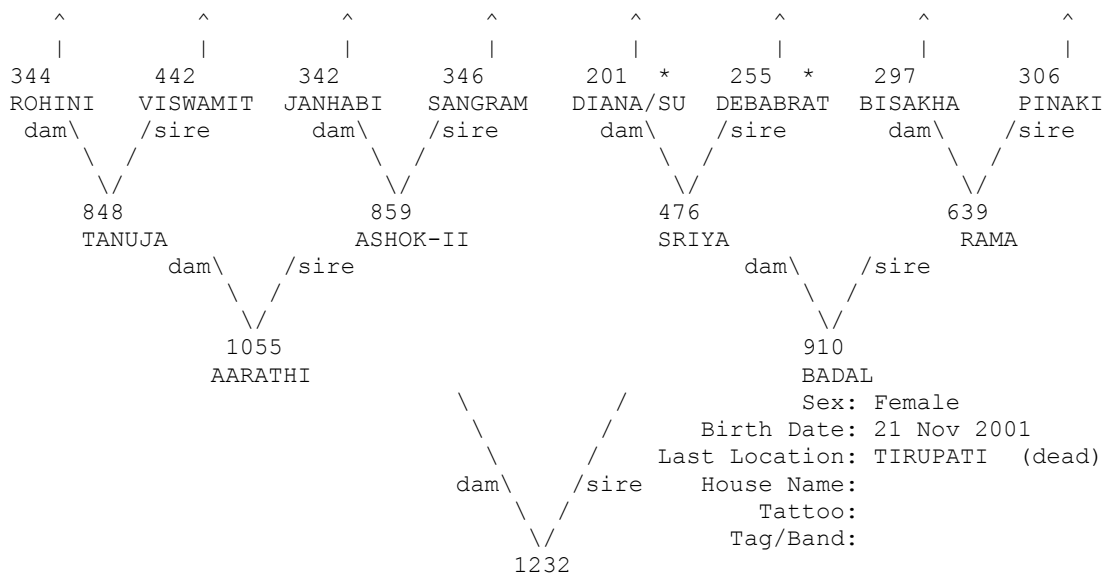

* Appear more than once...
 ^ Pedigree continues beyond top of page...

=====
 Taxon Name: PANTHERA TIGRIS Studbook Number: 1233
 =====

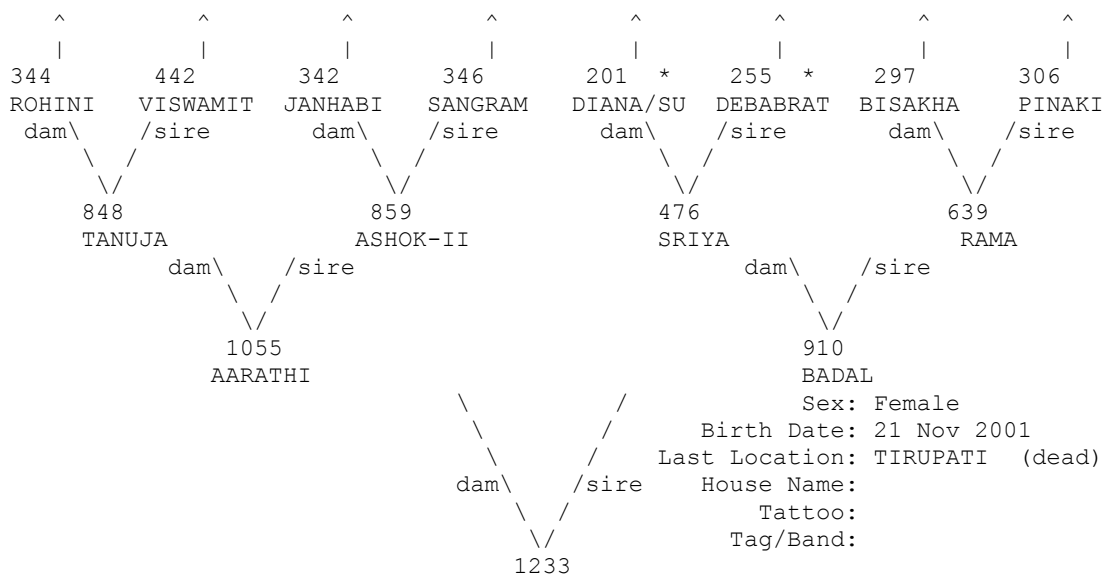

* Appear more than once...
 ^ Pedigree continues beyond top of page...

=====
 Taxon Name: PANTHERA TIGRIS Studbook Number: 1234
 =====

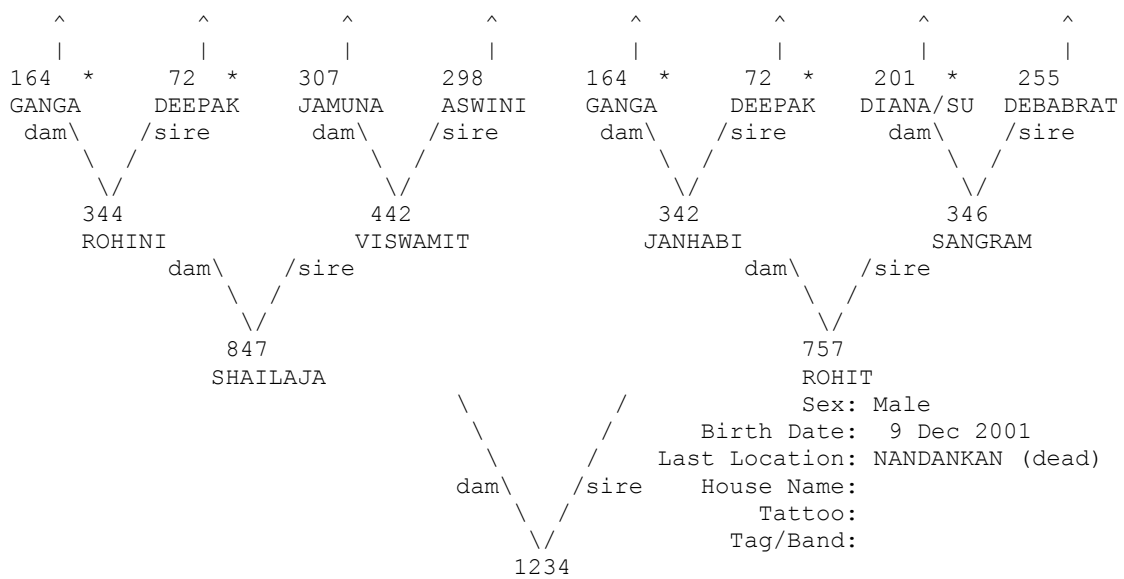

* Appear more than once...
 ^ Pedigree continues beyond top of page...

=====
 Taxon Name: PANTHERA TIGRIS Studbook Number: 1235
 =====

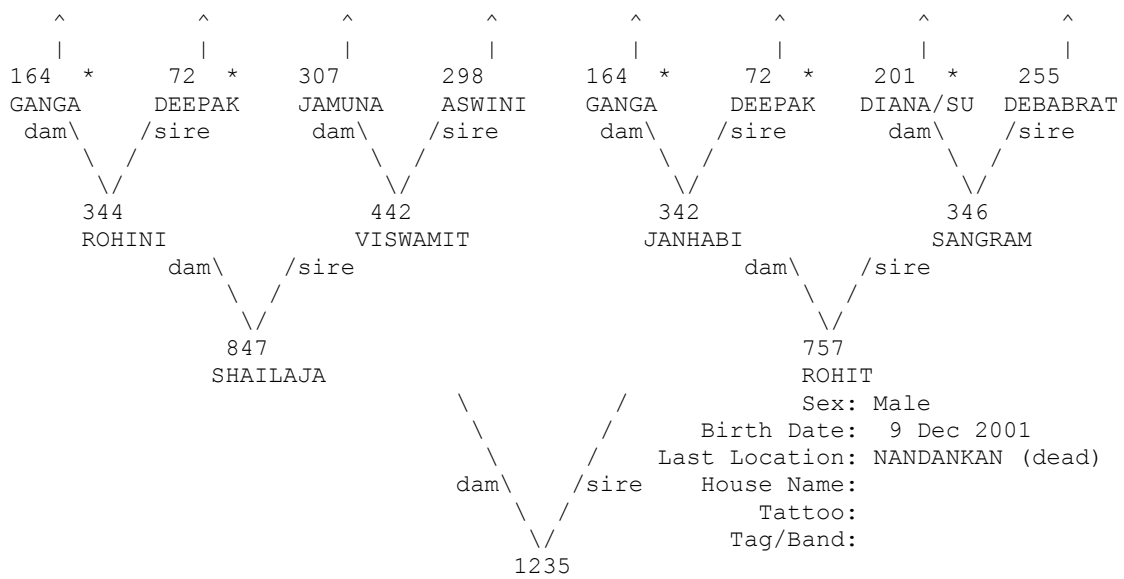

* Appear more than once...
 ^ Pedigree continues beyond top of page...

=====
 Taxon Name: PANTHERA TIGRIS Studbook Number: 1236
 =====

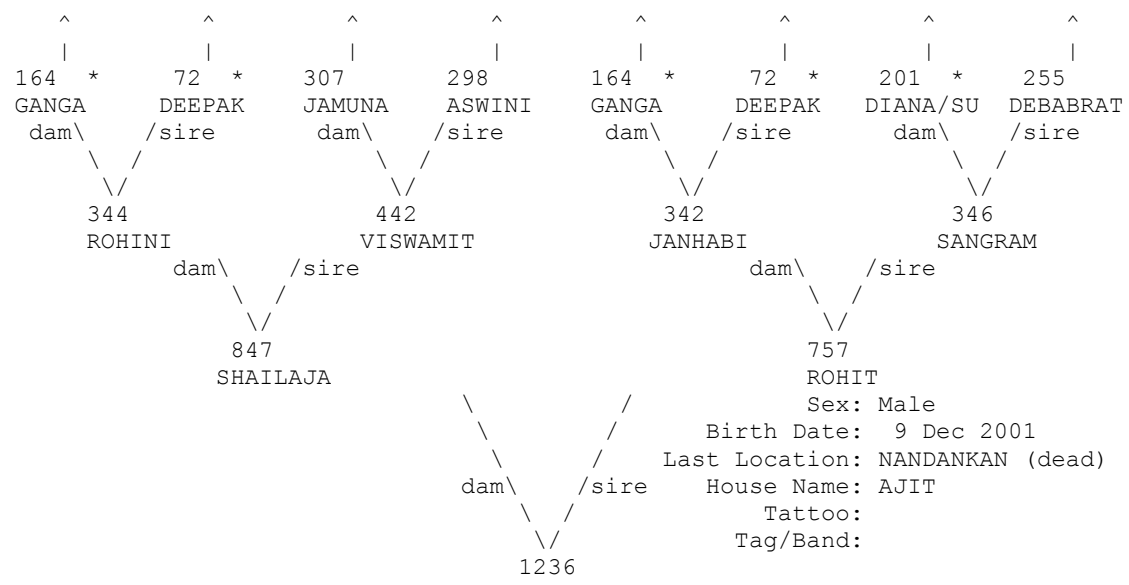

* Appear more than once...
 ^ Pedigree continues beyond top of page...

=====
 Taxon Name: PANTHERA TIGRIS Studbook Number: 1237
 =====

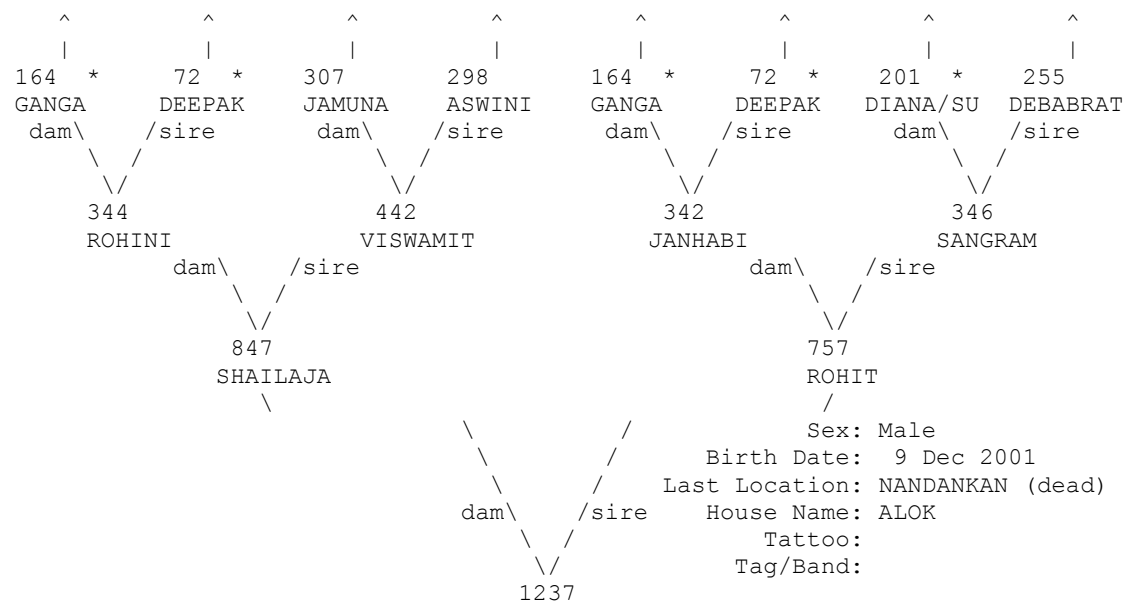

* Appear more than once...
 ^ Pedigree continues beyond top of page...

=====
 Taxon Name: PANTHERA TIGRIS Studbook Number: 1240
 =====

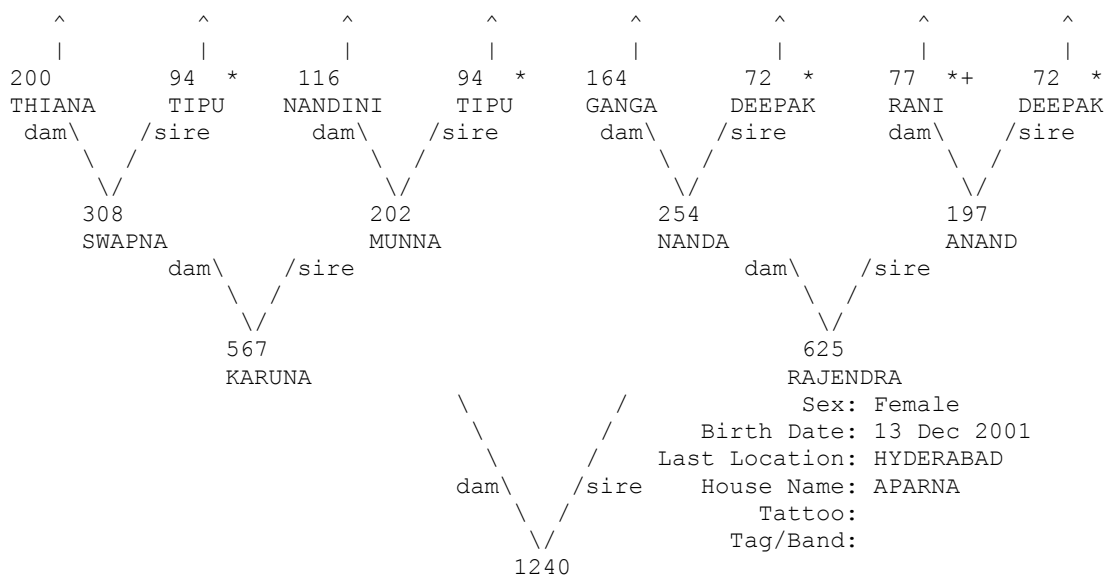

+ Wild-caught... * Appear more than once...
 ^ Pedigree continues beyond top of page...

=====
 Taxon Name: PANTHERA TIGRIS Studbook Number: 1241
 =====

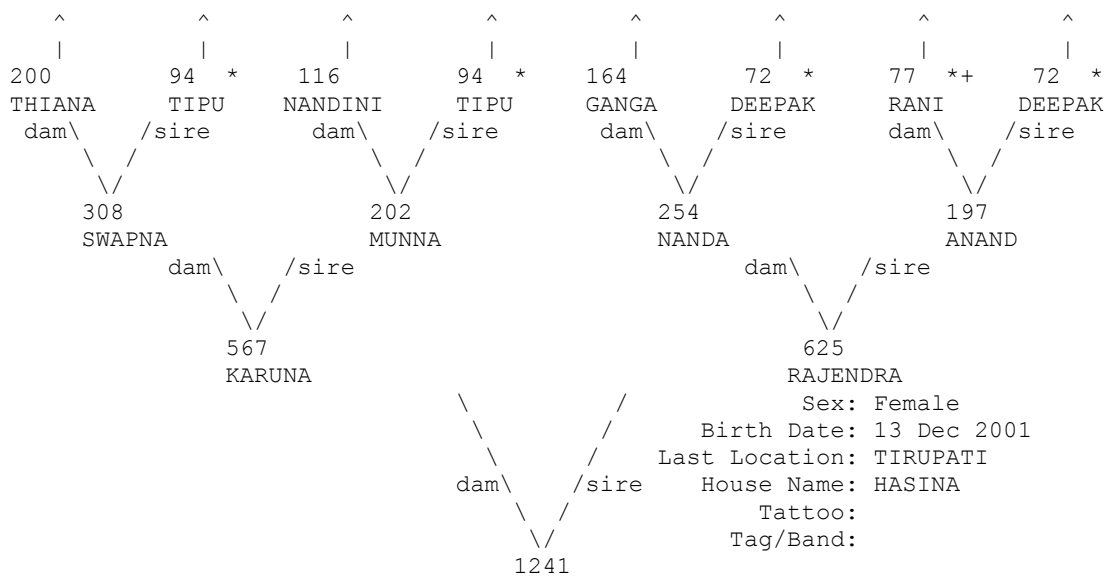

+ Wild-caught... * Appear more than once...
 ^ Pedigree continues beyond top of page...

=====
 Taxon Name: PANTHERA TIGRIS Studbook Number: 1242
 =====

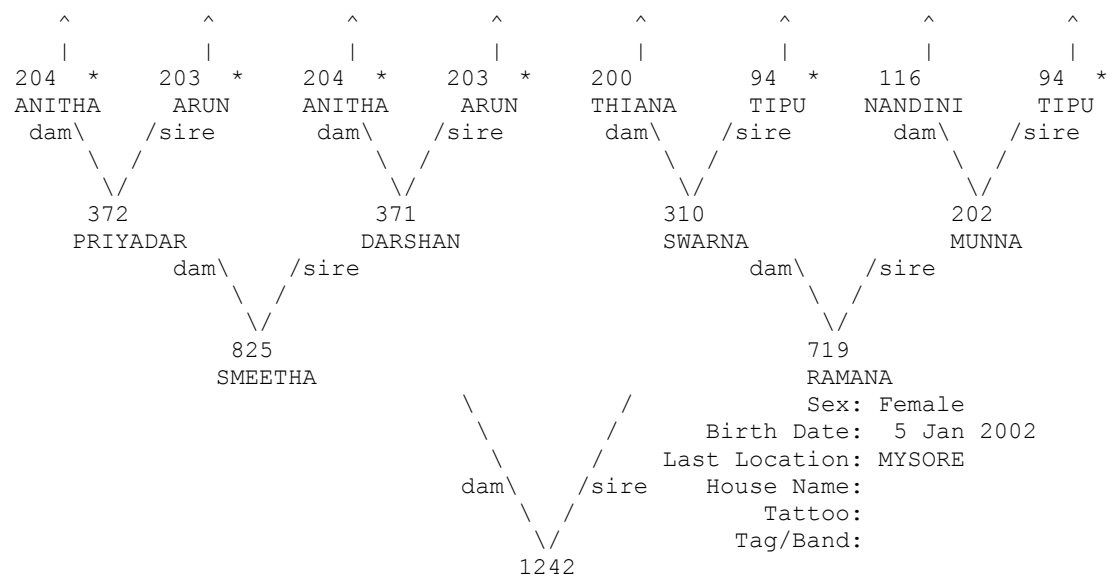

* Appear more than once...
 ^ Pedigree continues beyond top of page...

=====
 Taxon Name: PANTHERA TIGRIS Studbook Number: 1243
 =====

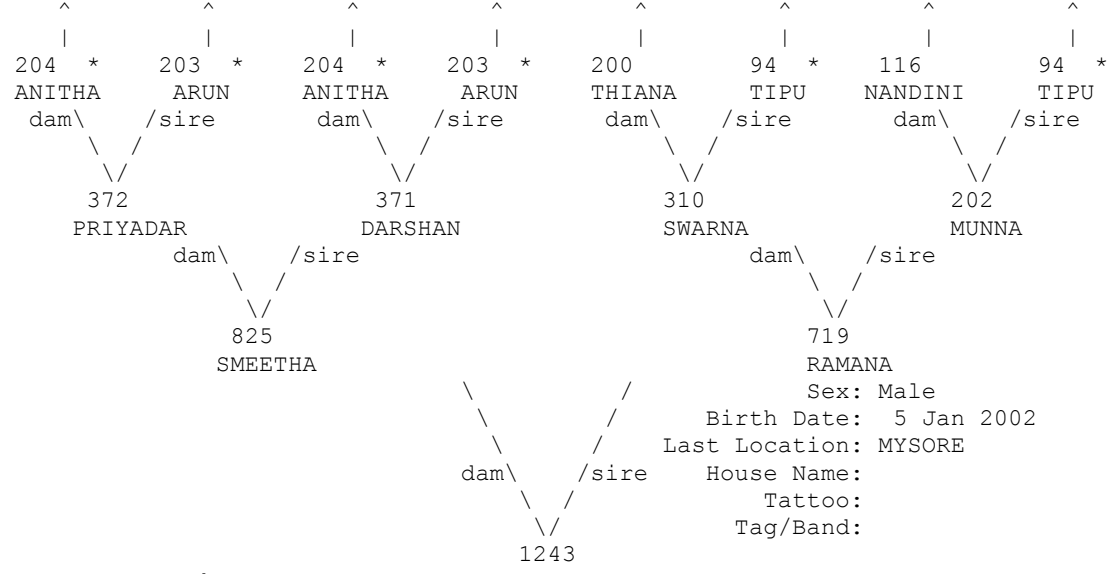

* Appear more than once...
 ^ Pedigree continues beyond top of page...

=====
 Taxon Name: PANTHERA TIGRIS Studbook Number: 1248
 =====

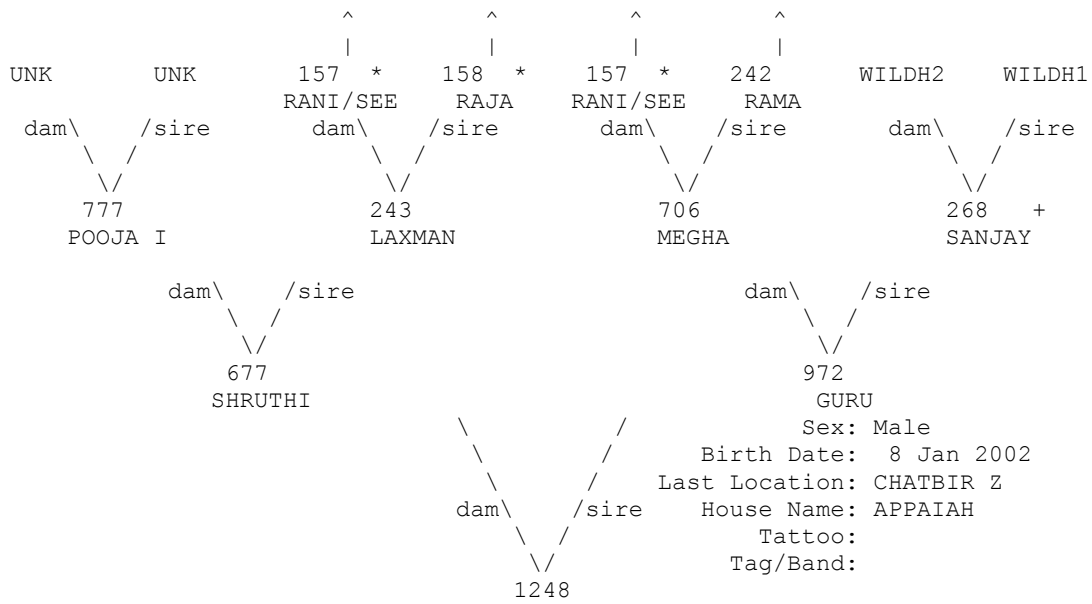

+ Wild-caught... * Appear more than once...
 ^ Pedigree continues beyond top of page...

=====
 Taxon Name: PANTHERA TIGRIS Studbook Number: 1249
 =====

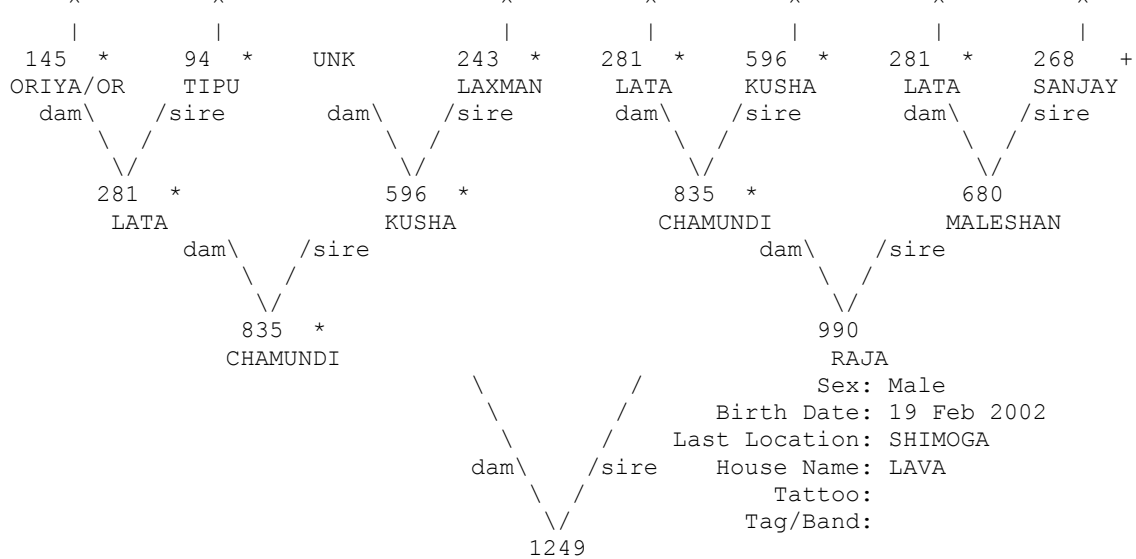

+ Wild-caught... * Appear more than once...
 ^ Pedigree continues beyond top of page...

=====
 Taxon Name: PANTHERA TIGRIS Studbook Number: 1250
 =====

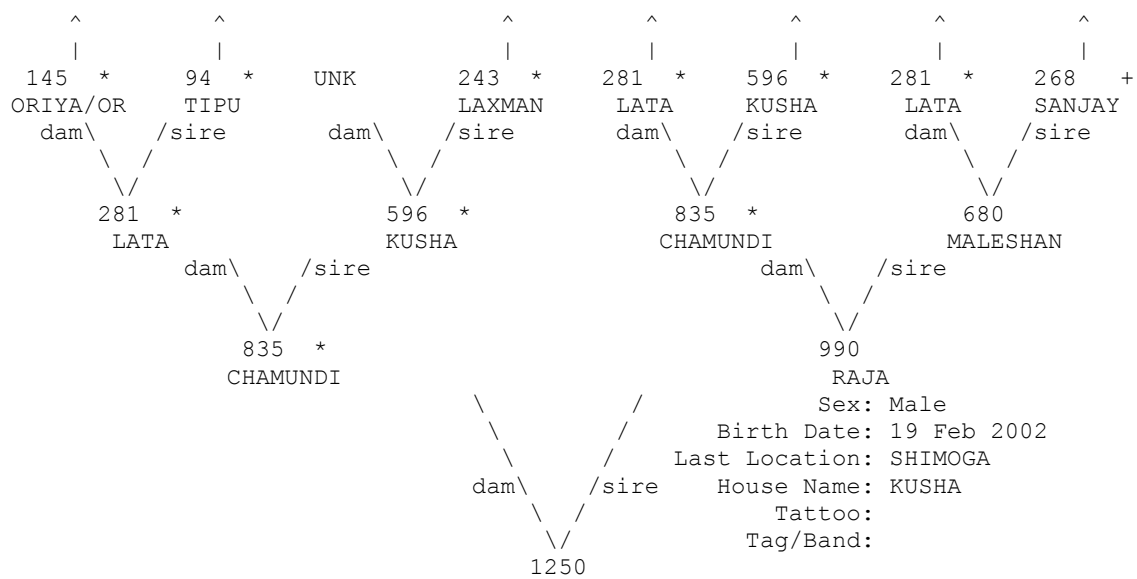

+ Wild-caught... * Appear more than once...
 ^ Pedigree continues beyond top of page...

=====
 Taxon Name: PANTHERA TIGRIS Studbook Number: 1251
 =====

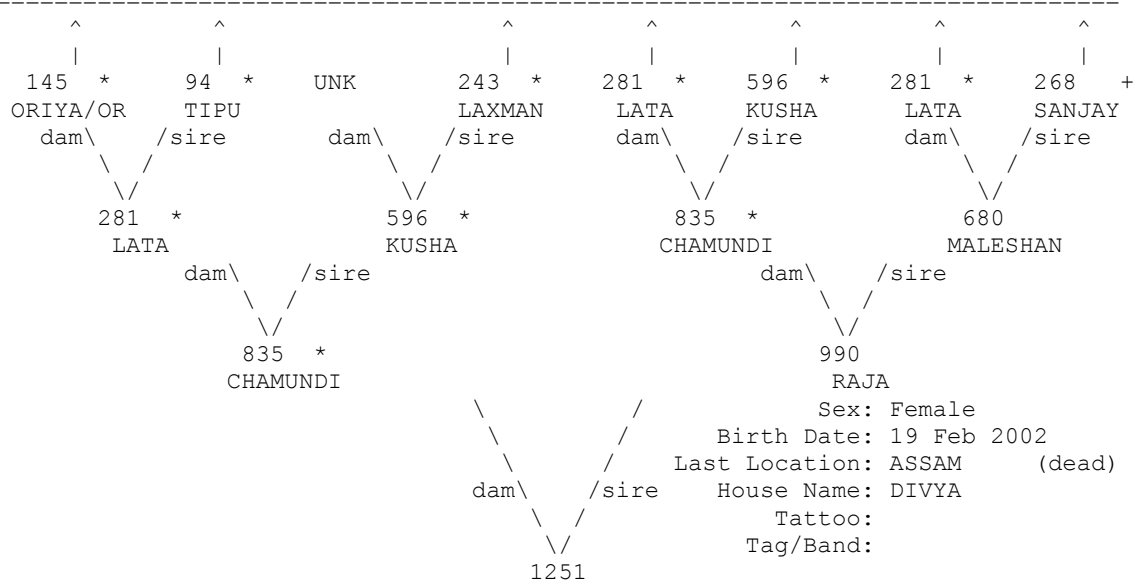

+ Wild-caught... * Appear more than once...
 ^ Pedigree continues beyond top of page...

=====
 Taxon Name: PANTHERA TIGRIS Studbook Number: 1252
 =====

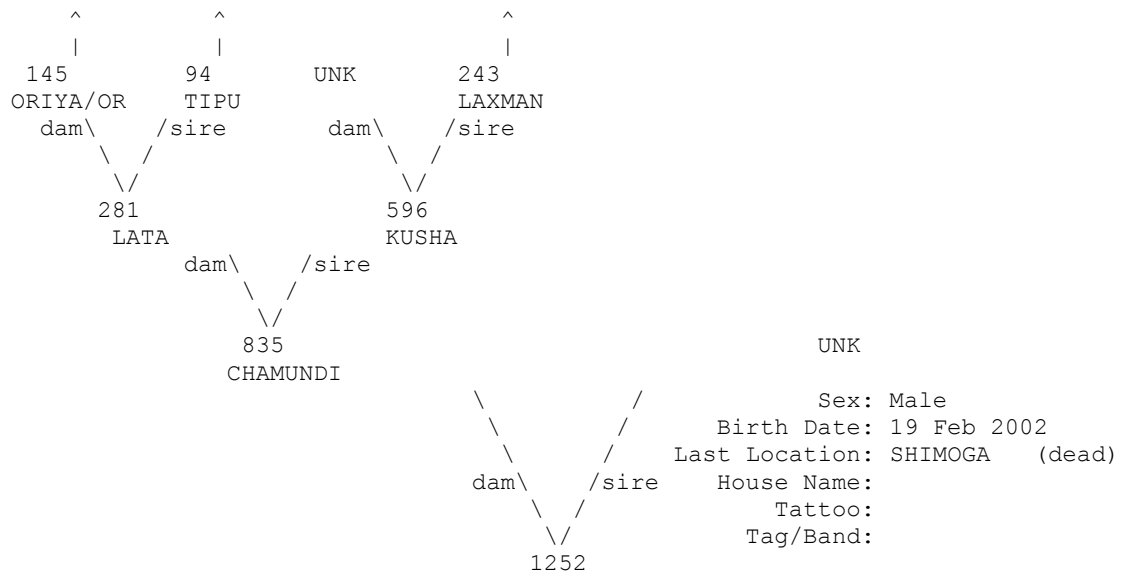

* Appear more than once...
 ^ Pedigree continues beyond top of page...

=====
 Taxon Name: PANTHERA TIGRIS Studbook Number: 1253
 =====

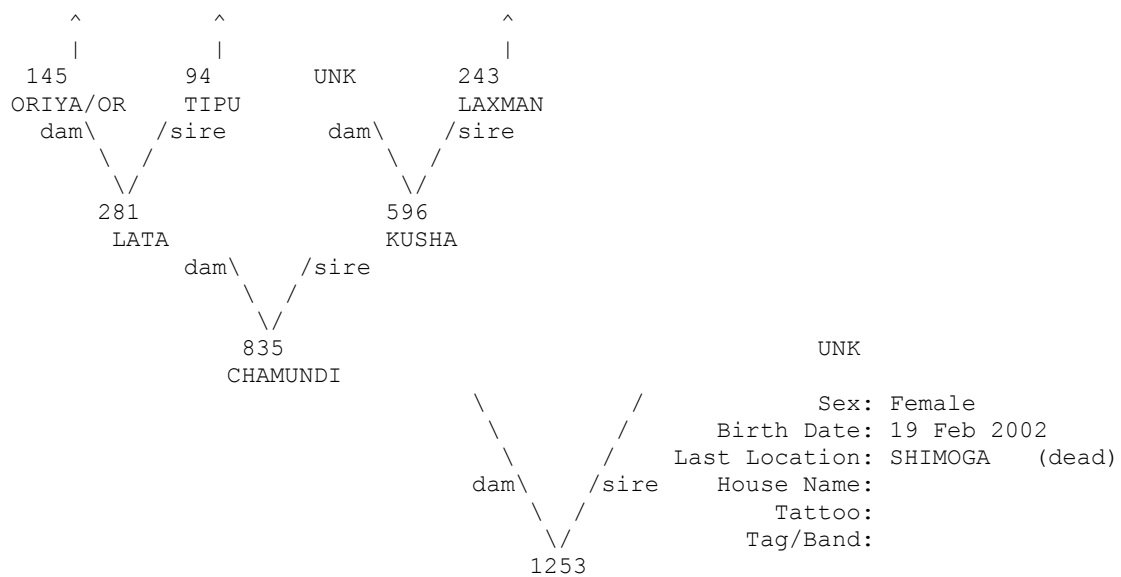

* Appear more than once...
 ^ Pedigree continues beyond top of page...

=====
 Taxon Name: PANTHERA TIGRIS Studbook Number: 1254
 =====

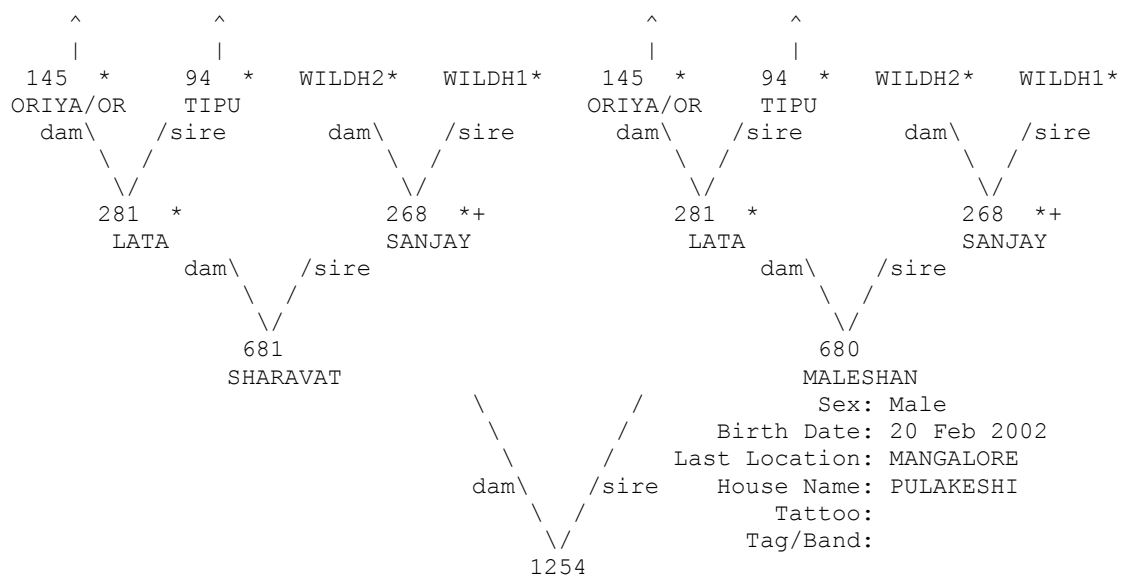

+ Wild-caught... * Appear more than once...
 ^ Pedigree continues beyond top of page...

=====
 Taxon Name: PANTHERA TIGRIS Studbook Number: 1255
 =====

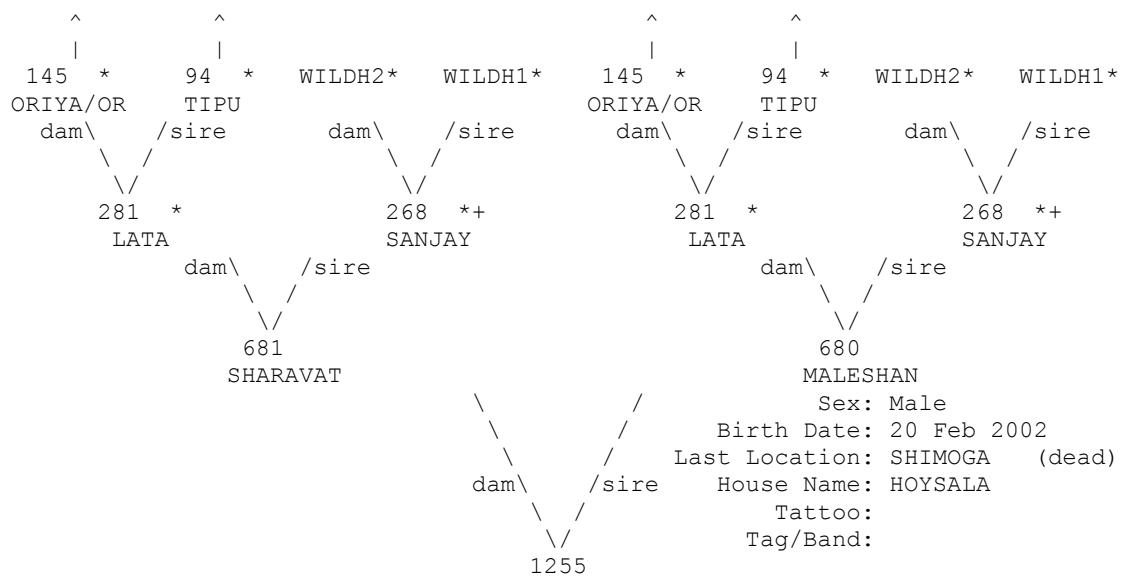

+ Wild-caught... * Appear more than once...
 ^ Pedigree continues beyond top of page...

=====
 Taxon Name: PANTHERA TIGRIS Studbook Number: 1256
 =====

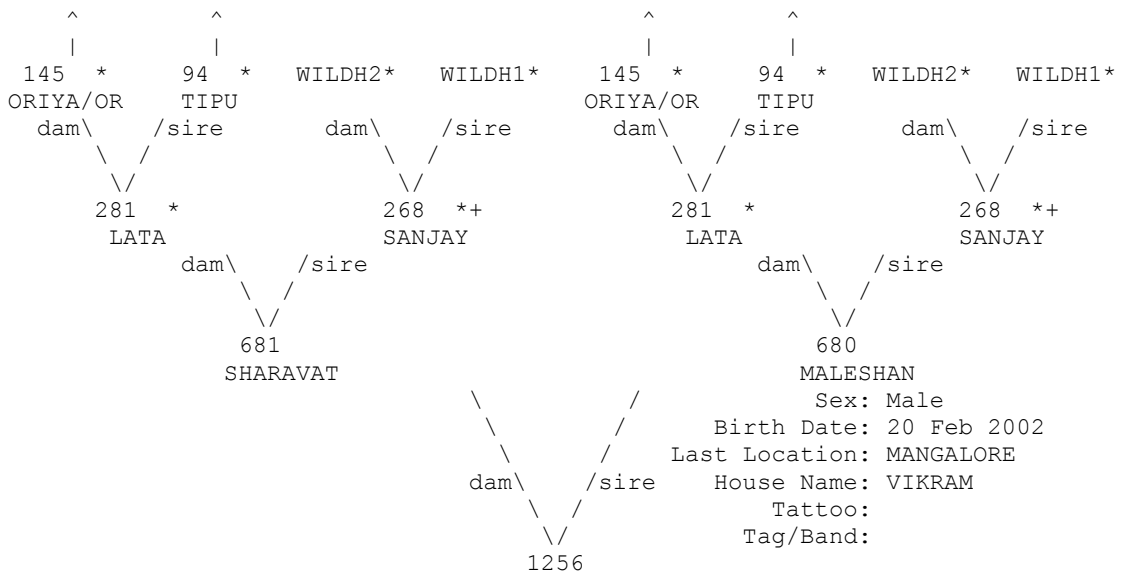

+ Wild-caught... * Appear more than once...
 ^ Pedigree continues beyond top of page...

=====
 Taxon Name: PANTHERA TIGRIS Studbook Number: 1257
 =====

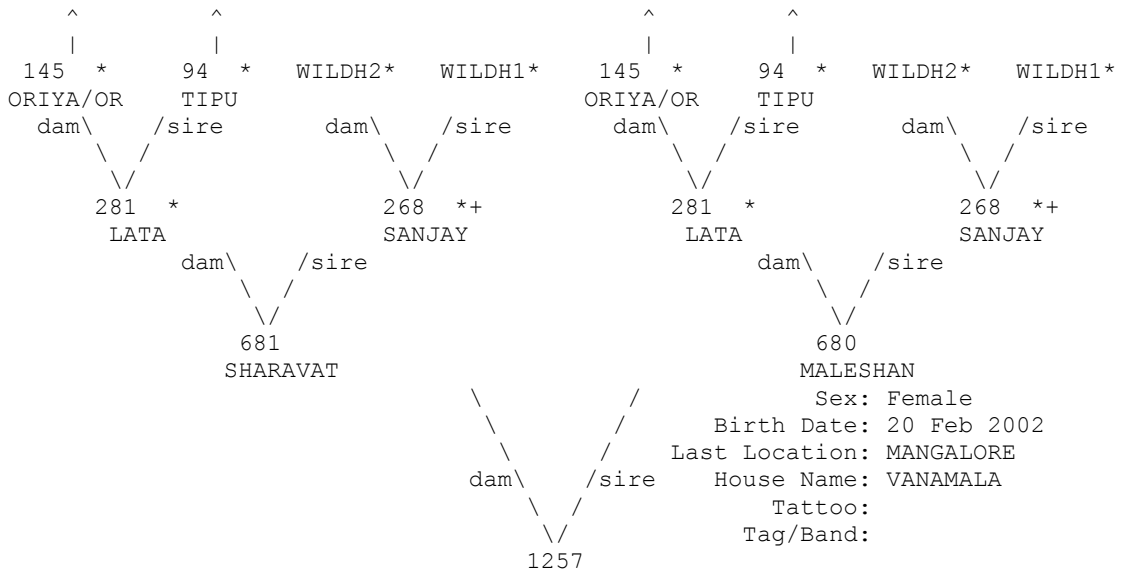

+ Wild-caught... * Appear more than once...
 ^ Pedigree continues beyond top of page...

=====
 Taxon Name: PANTHERA TIGRIS Studbook Number: 1258
 =====

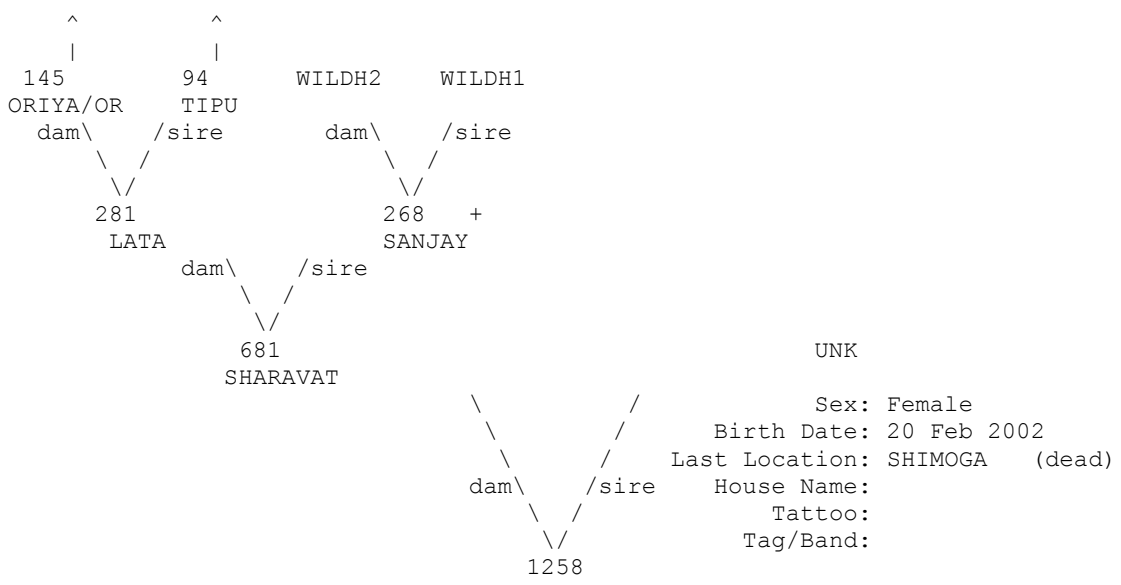

+ Wild-caught...
 ^ Pedigree continues beyond top of page...

=====
 Taxon Name: PANTHERA TIGRIS Studbook Number: 1259
 =====

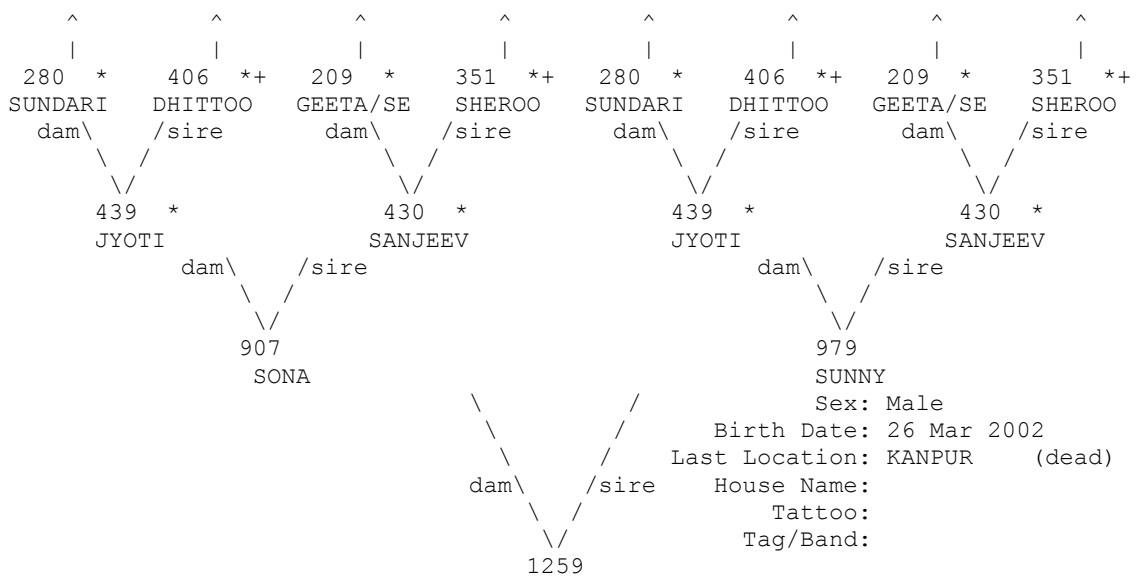

+ Wild-caught... * Appear more than once...
 ^ Pedigree continues beyond top of page...

=====
 Taxon Name: PANTHERA TIGRIS Studbook Number: 1260
 =====

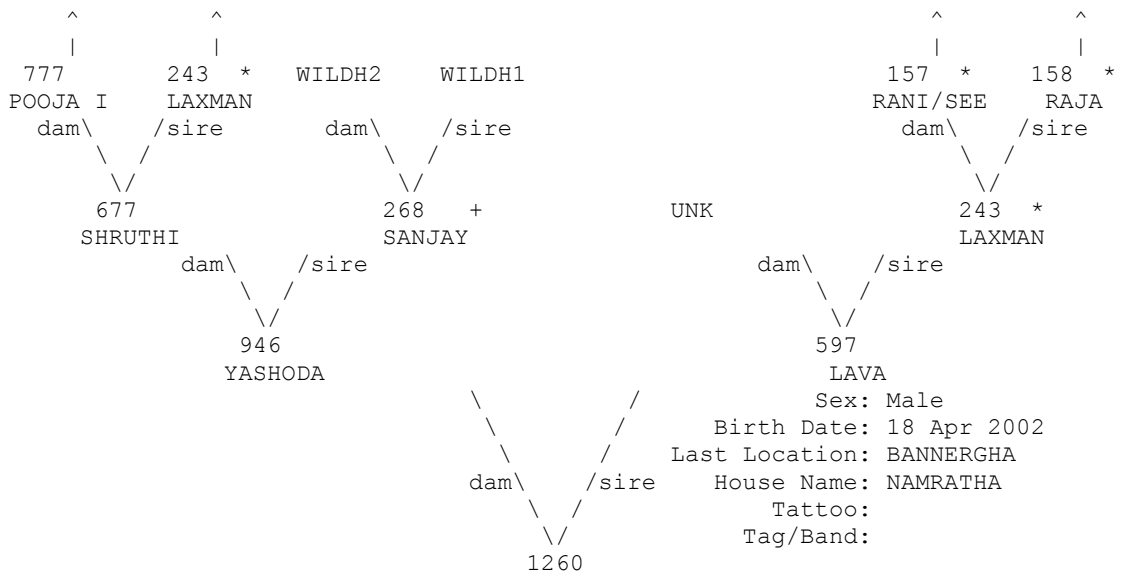

+ Wild-caught... * Appear more than once...
 ^ Pedigree continues beyond top of page...

=====
 Taxon Name: PANTHERA TIGRIS Studbook Number: 1261
 =====

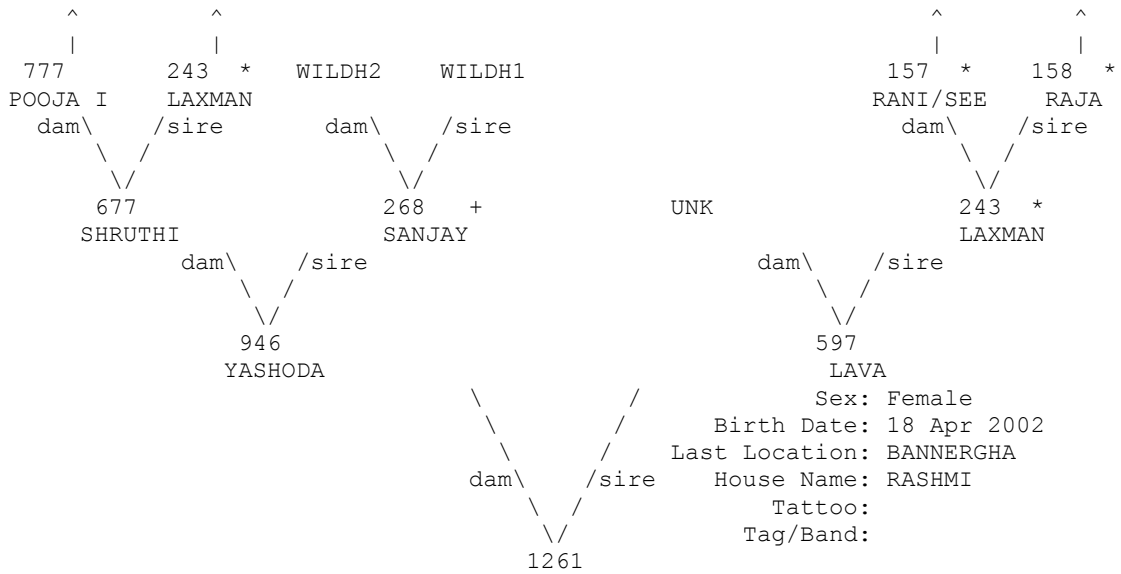

+ Wild-caught... * Appear more than once...
 ^ Pedigree continues beyond top of page...

=====
 Taxon Name: PANTHERA TIGRIS Studbook Number: 1262
 =====

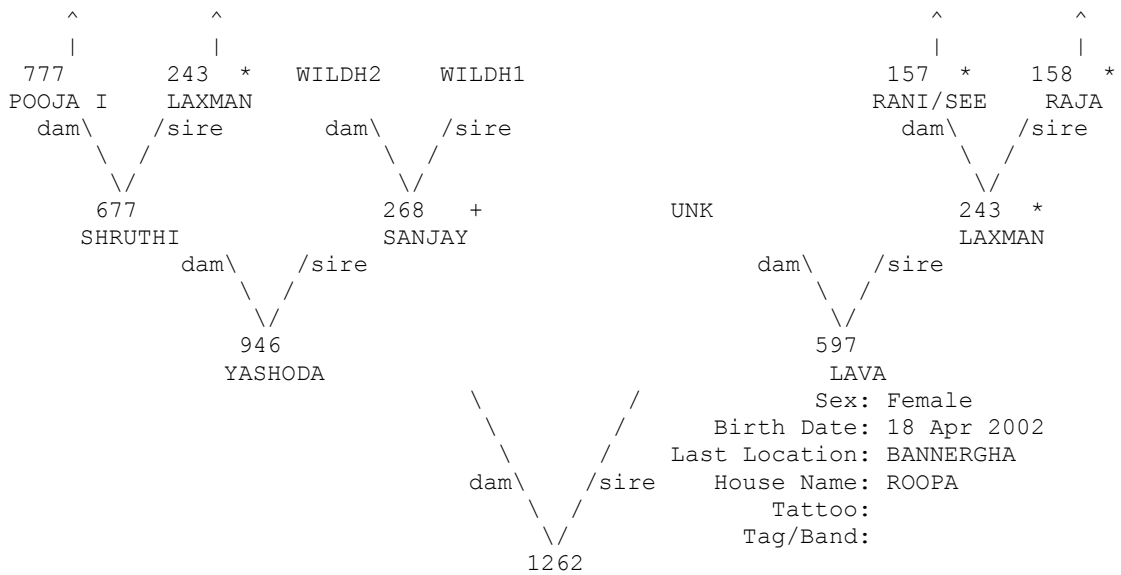

+ Wild-caught... * Appear more than once...
 ^ Pedigree continues beyond top of page...

=====
 Taxon Name: PANTHERA TIGRIS Studbook Number: 1263
 =====

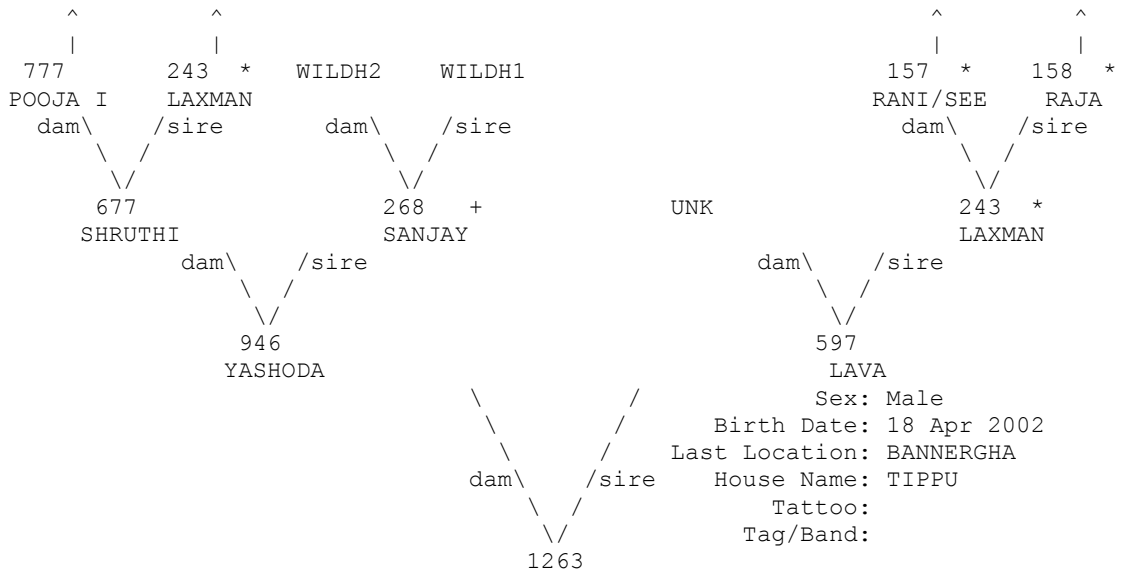

+ Wild-caught... * Appear more than once...
 ^ Pedigree continues beyond top of page...

=====
 Taxon Name: PANTHERA TIGRIS Studbook Number: 1264
 =====

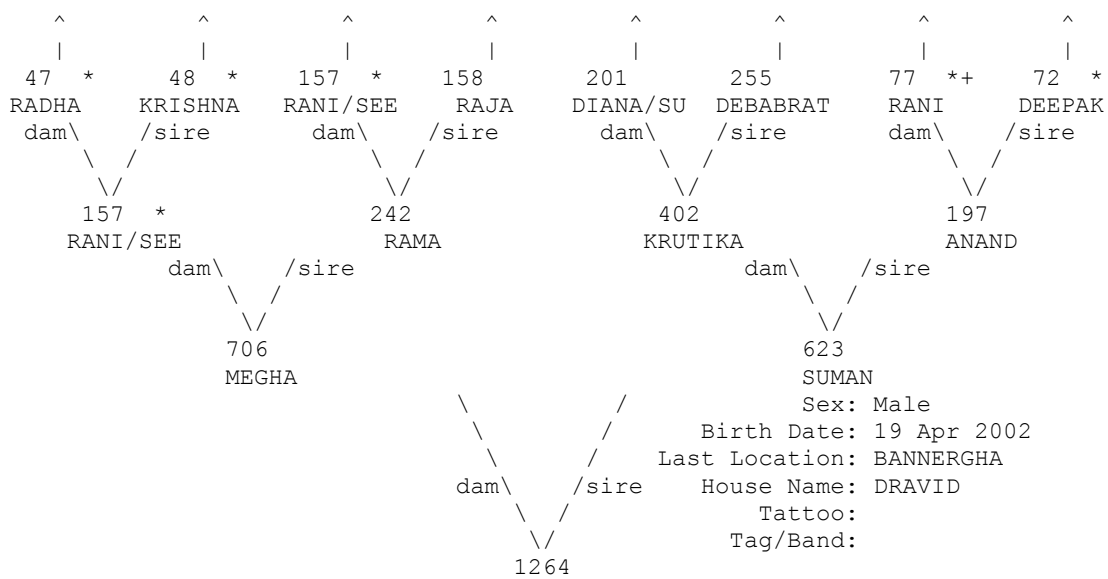

+ Wild-caught... * Appear more than once...
 ^ Pedigree continues beyond top of page...

=====
 Taxon Name: PANTHERA TIGRIS Studbook Number: 1265
 =====

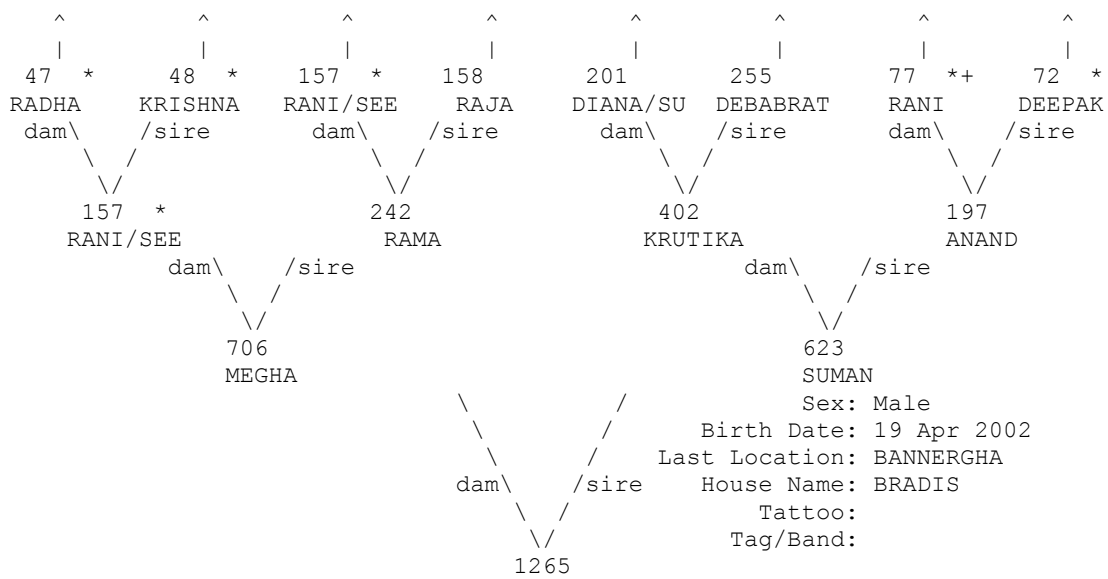

+ Wild-caught... * Appear more than once...
 ^ Pedigree continues beyond top of page...

=====
 Taxon Name: PANTHERA TIGRIS Studbook Number: 1266
 =====

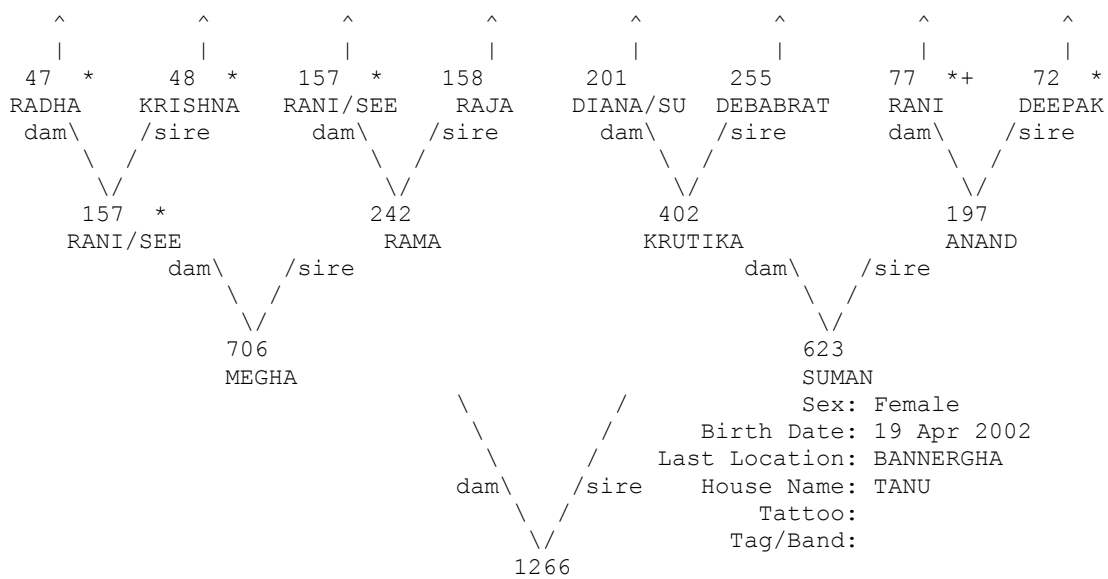

+ Wild-caught... * Appear more than once...
 ^ Pedigree continues beyond top of page...

=====
 Taxon Name: PANTHERA TIGRIS Studbook Number: 1267
 =====

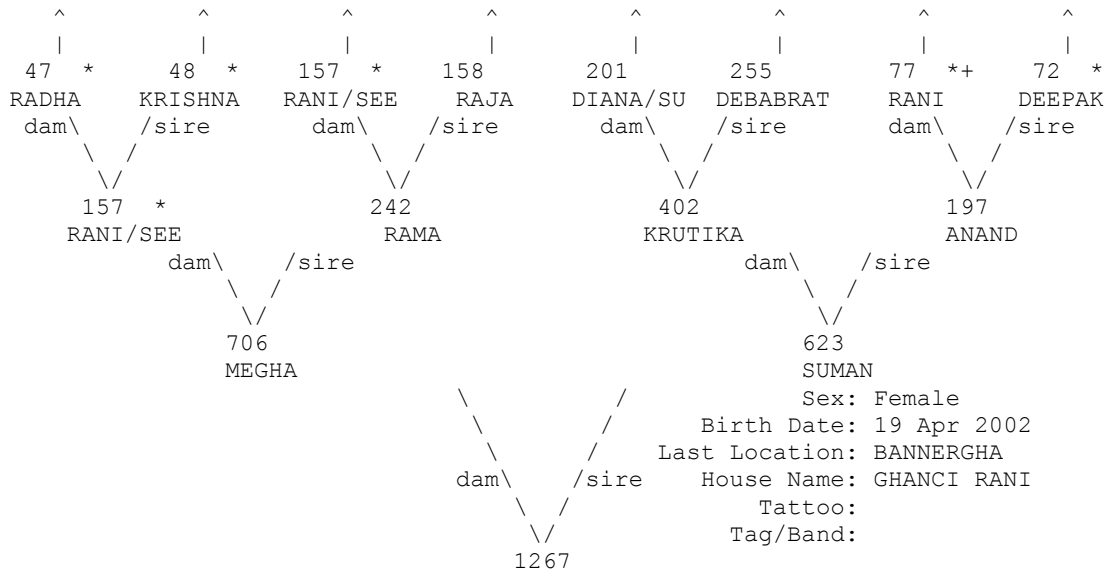

+ Wild-caught... * Appear more than once...
 ^ Pedigree continues beyond top of page...

```

=====
Taxon Name: PANTHERA TIGRIS                      Studbook Number: 1268
=====
WILD
                                WILD
                                Sex: Male
                                Birth Date: ~ 1997
                                Last Location: BANNERGHA
                                House Name: MASTI
                                Tattoo:
                                Tag/Band:
                                dam\ /sire
                                \ /
                                1268

```

```

=====
Taxon Name: PANTHERA TIGRIS                      Studbook Number: 1269
=====
UNK                                UNK                                UNK                                UNK
dam\ /sire                          dam\ /sire
 \ /                                  \ /
 1124                                1123
 RITA                                PINTU
                                Sex: Male
                                Birth Date: 23 Jun 2002
                                Last Location: CHATBIR Z
                                House Name: PARAS
                                Tattoo:
                                Tag/Band:
                                dam\ /sire
                                \ /
                                1269

```

```

=====
Taxon Name: PANTHERA TIGRIS                      Studbook Number: 1270
=====
^ ^ ^ ^ ^ ^ ^ ^
| | | | | | | |
47 * 48 * 157 * 158 201 255 77 *+ 72 *
RADHA KRISHNA RANI/SEE RAJA DIANA/SU DEBABRAT RANI DEEPAK
dam\ /sire dam\ /sire dam\ /sire dam\ /sire dam\ /sire dam\ /sire
 \ / \ / \ / \ / \ / \ / \ / \ /
 157 * 242 402 197
 RANI/SEE RAMA KRUTIKA ANAND
 dam\ /sire dam\ /sire
 \ / \ /
 706 623
 MEGHA SUMAN
                                Sex: Female
                                Birth Date: 24 Jul 2002
                                Last Location: BANNERGHA
                                House Name: KALPANA CHAWLA
                                Tattoo:
                                Tag/Band:
                                dam\ /sire
                                \ /
                                1270

```

+ Wild-caught... * Appear more than once...
^ Pedigree continues beyond top of page...

=====
 Taxon Name: PANTHERA TIGRIS Studbook Number: 1271
 =====

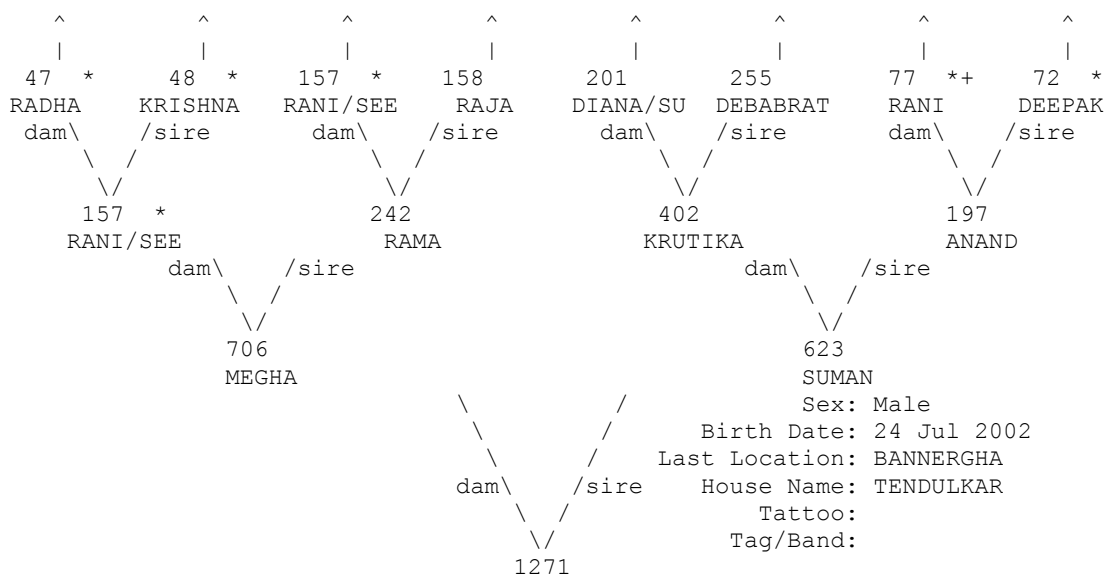

+ Wild-caught... * Appear more than once...
 ^ Pedigree continues beyond top of page...

=====
 Taxon Name: PANTHERA TIGRIS Studbook Number: 1272
 =====

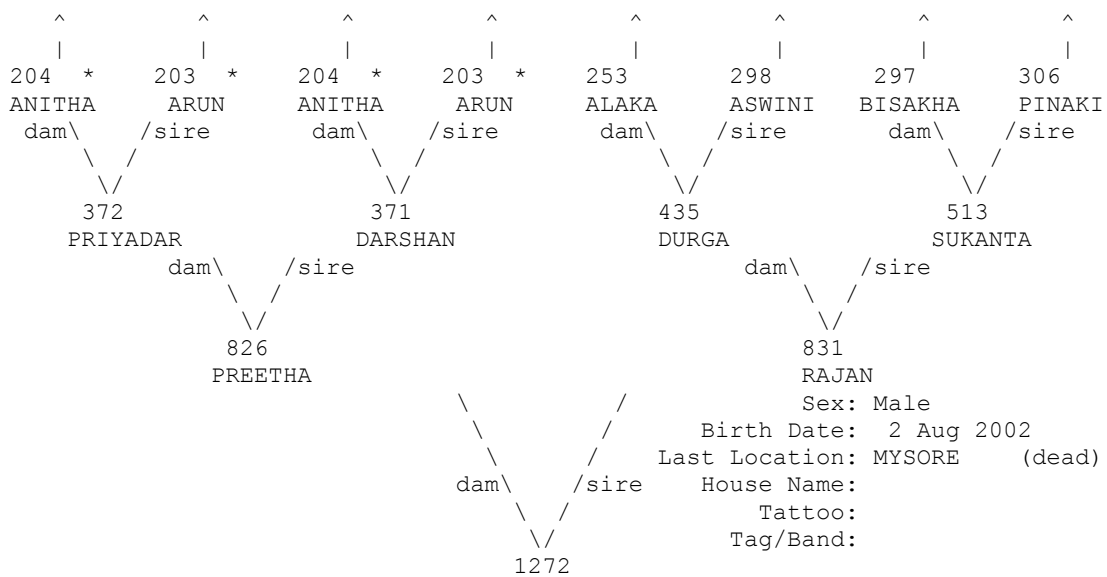

* Appear more than once...
 ^ Pedigree continues beyond top of page...

=====
 Taxon Name: PANTHERA TIGRIS Studbook Number: 1273
 =====

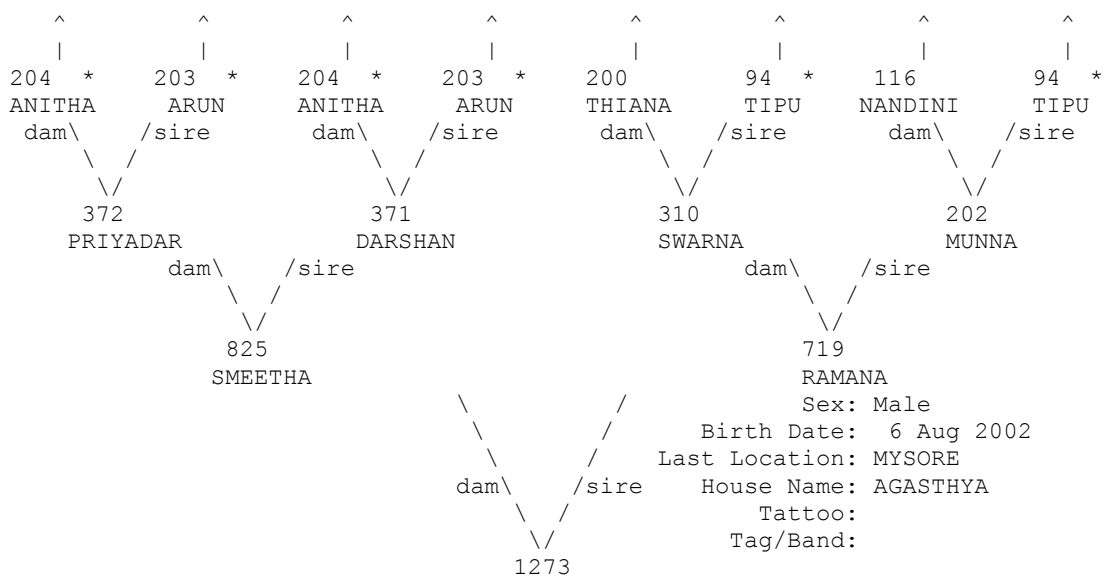

* Appear more than once...
 ^ Pedigree continues beyond top of page...

=====
 Taxon Name: PANTHERA TIGRIS Studbook Number: 1274
 =====

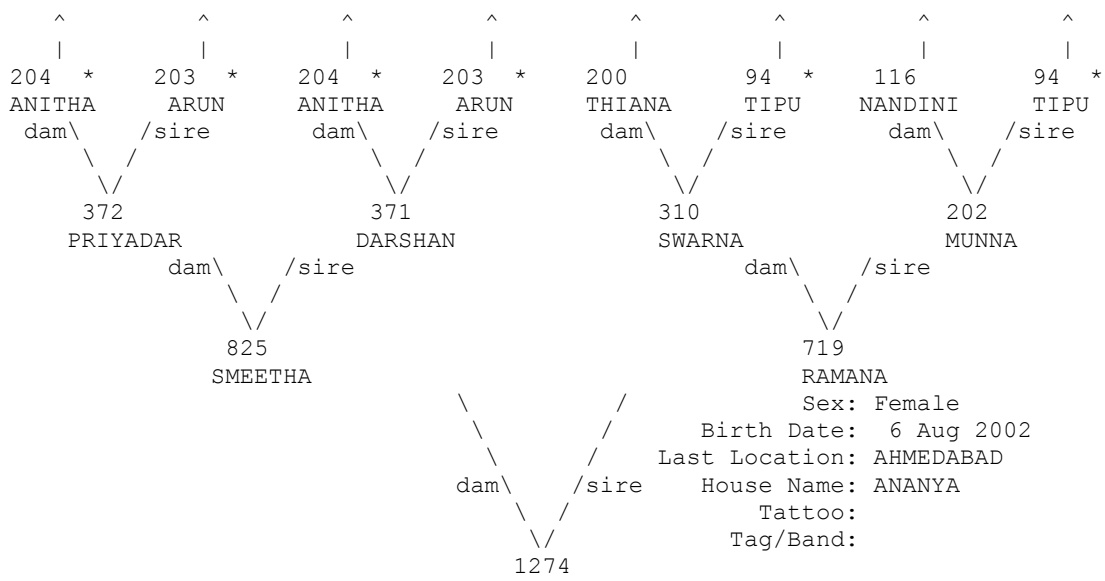

* Appear more than once...
 ^ Pedigree continues beyond top of page...

=====
 Taxon Name: PANTHERA TIGRIS Studbook Number: 1275
 =====

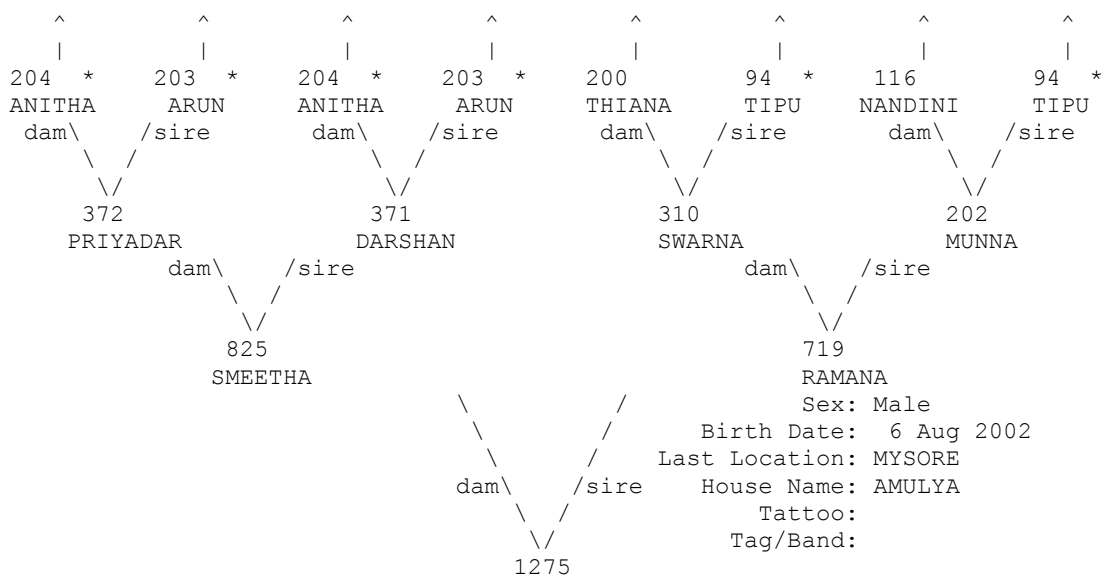

* Appear more than once...
 ^ Pedigree continues beyond top of page...

=====
 Taxon Name: PANTHERA TIGRIS Studbook Number: 1276
 =====

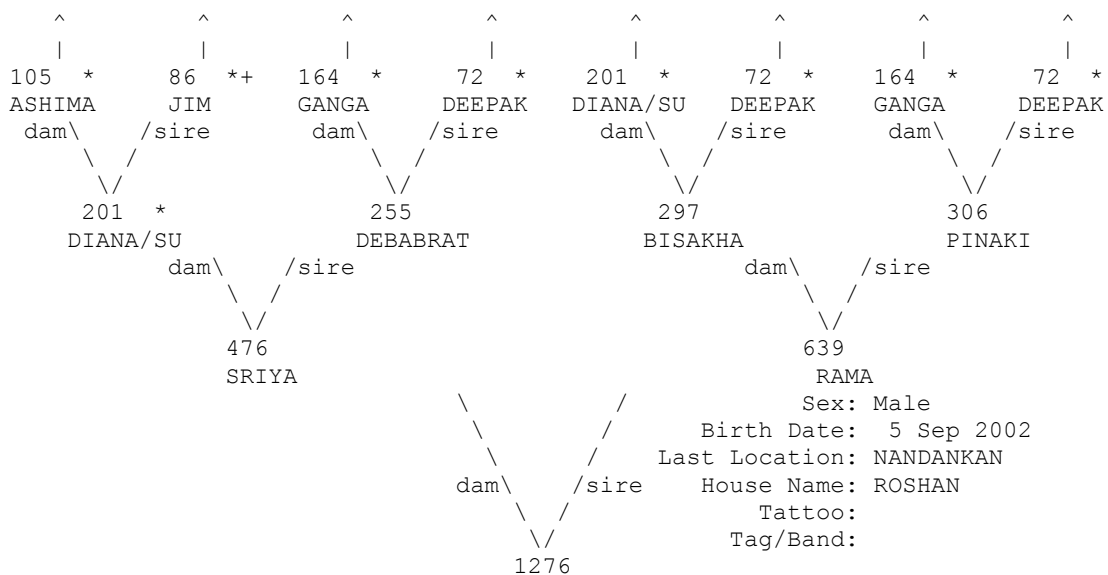

+ Wild-caught... * Appear more than once...
 ^ Pedigree continues beyond top of page...

=====
 Taxon Name: PANTHERA TIGRIS Studbook Number: 1277
 =====

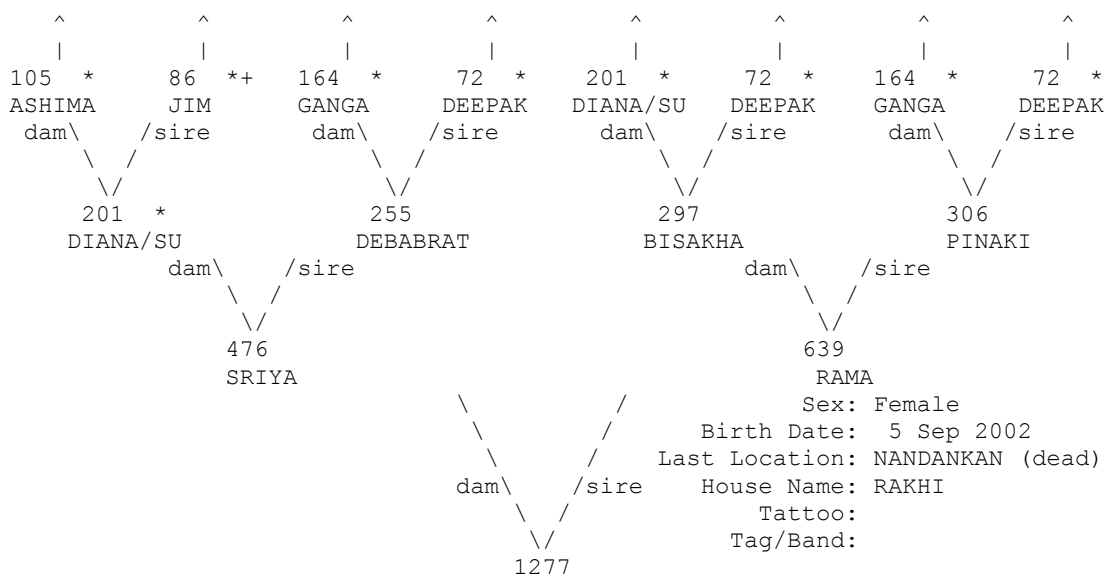

+ Wild-caught... * Appear more than once...
 ^ Pedigree continues beyond top of page...

=====
 Taxon Name: PANTHERA TIGRIS Studbook Number: 1278
 =====

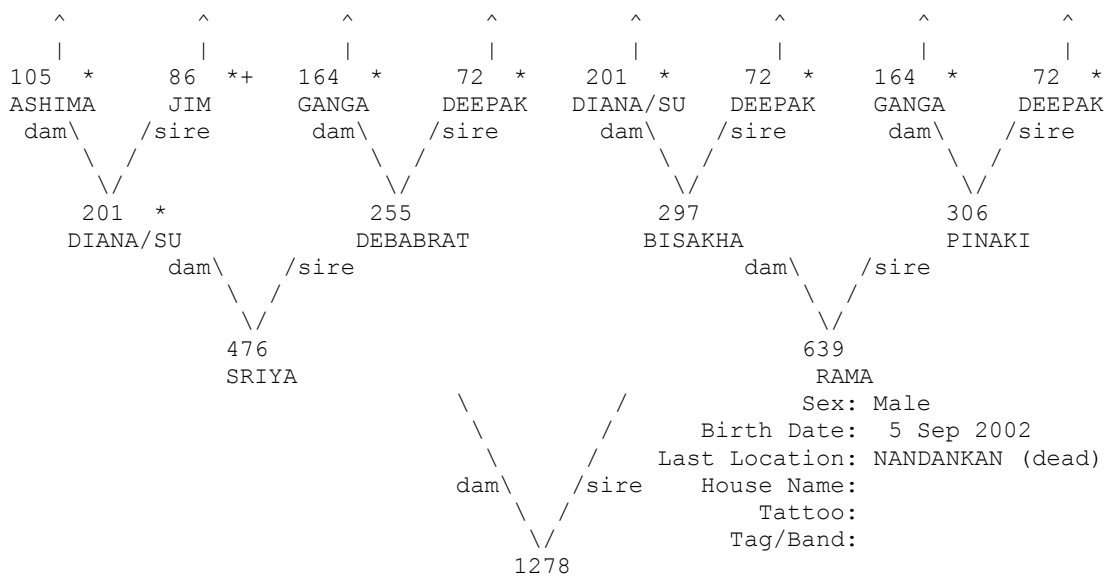

+ Wild-caught... * Appear more than once...
 ^ Pedigree continues beyond top of page...

=====
 Taxon Name: PANTHERA TIGRIS Studbook Number: 1281
 =====

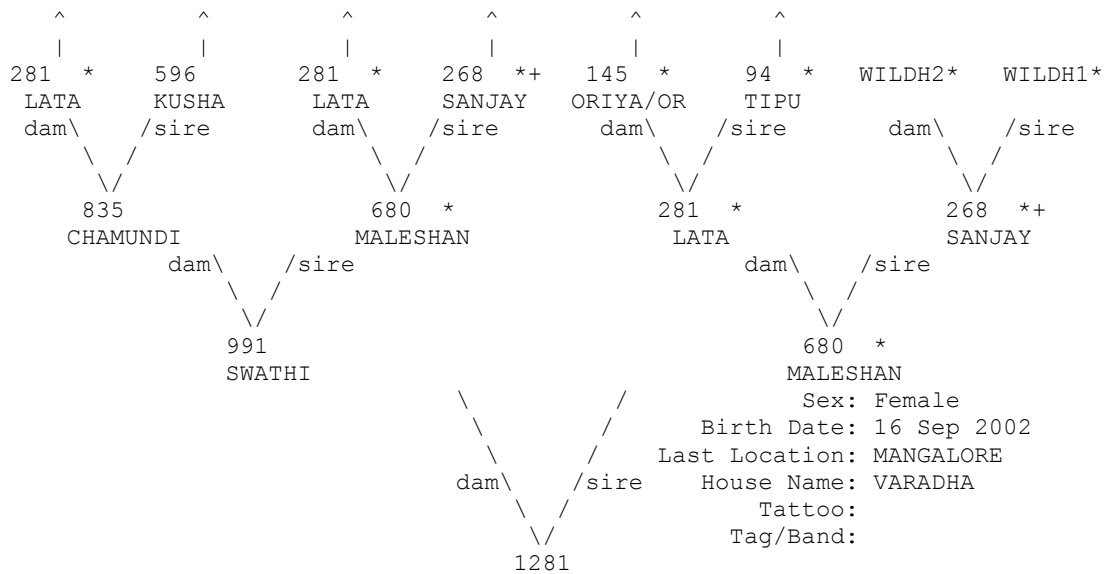

+ Wild-caught... * Appear more than once...
 ^ Pedigree continues beyond top of page...

=====
 Taxon Name: PANTHERA TIGRIS Studbook Number: 1282
 =====

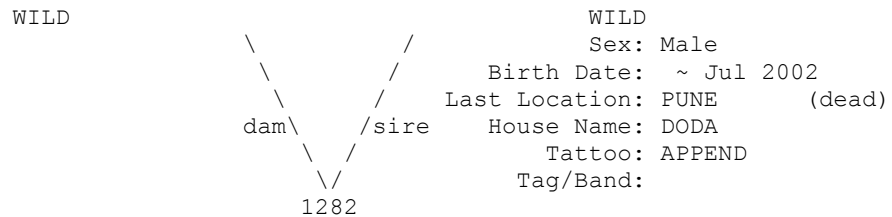

=====
 Taxon Name: PANTHERA TIGRIS Studbook Number: 1283
 =====

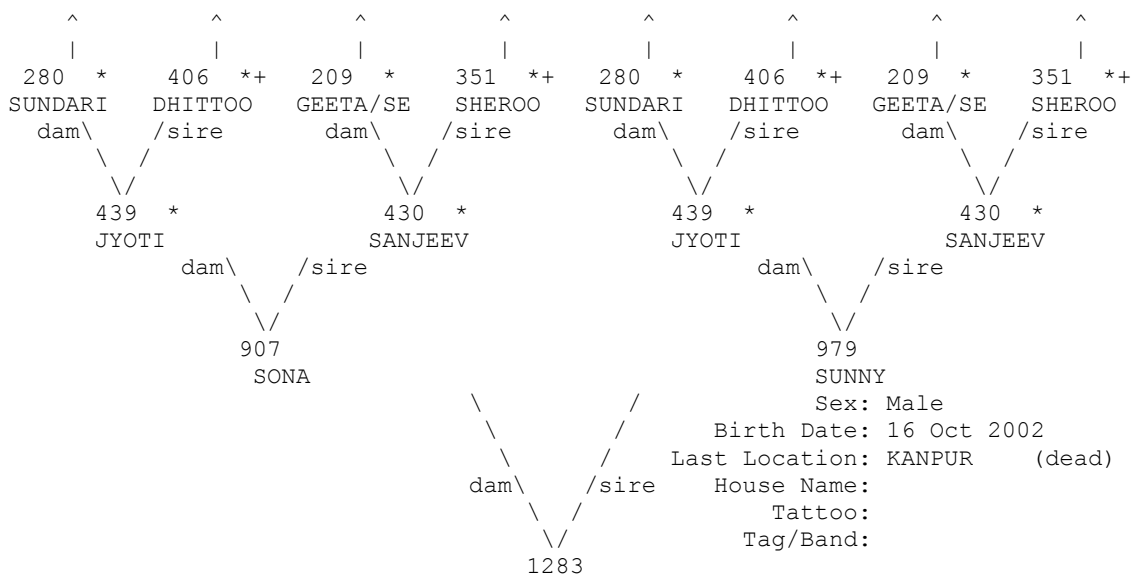

+ Wild-caught... * Appear more than once...
 ^ Pedigree continues beyond top of page...

=====
 Taxon Name: PANTHERA TIGRIS Studbook Number: 1288
 =====

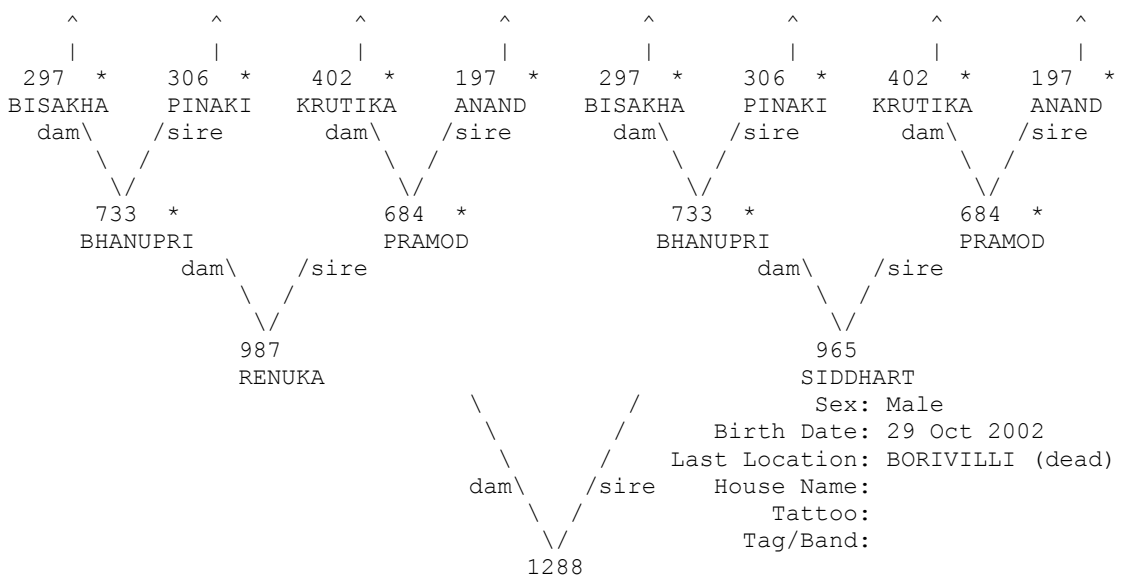

* Appear more than once...
 ^ Pedigree continues beyond top of page...

=====
 Taxon Name: PANTHERA TIGRIS Studbook Number: 1289
 =====

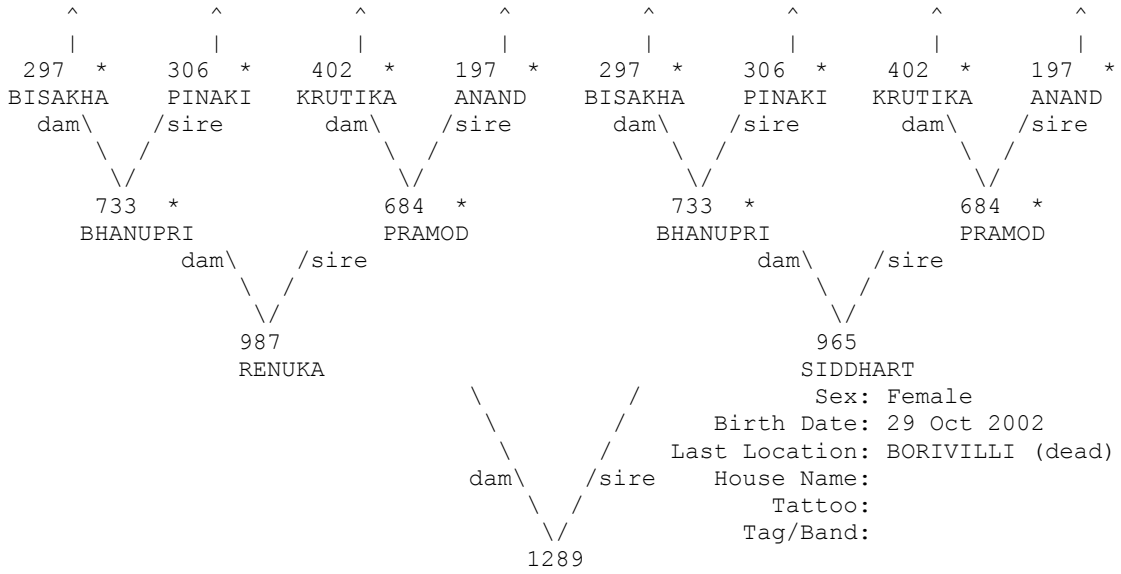

* Appear more than once...
 ^ Pedigree continues beyond top of page...

=====
 Taxon Name: PANTHERA TIGRIS Studbook Number: 1293
 =====

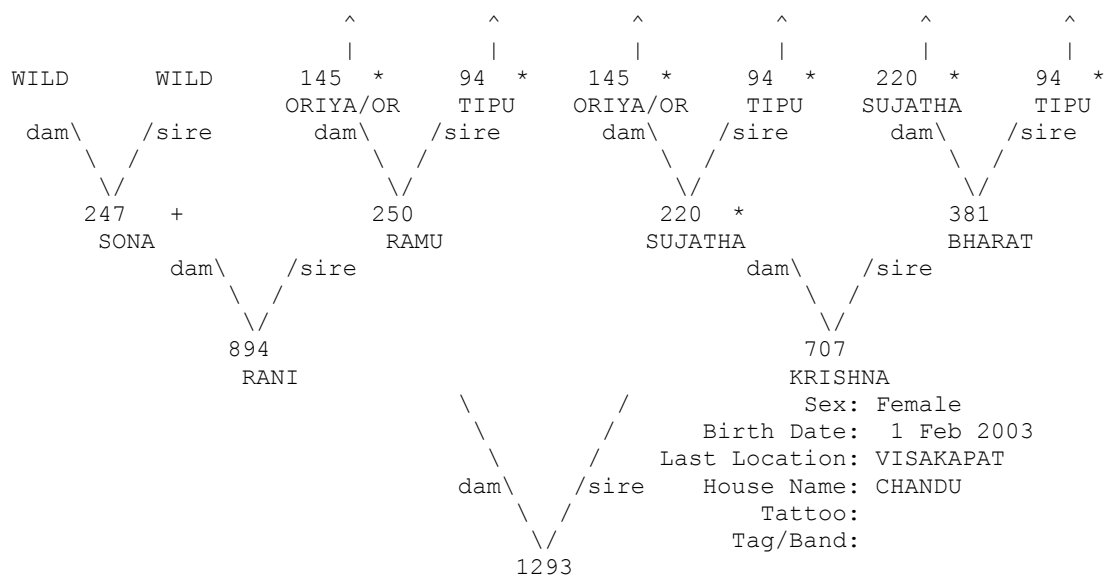

+ Wild-caught... * Appear more than once...
 ^ Pedigree continues beyond top of page...

=====
 Taxon Name: PANTHERA TIGRIS Studbook Number: 1294
 =====

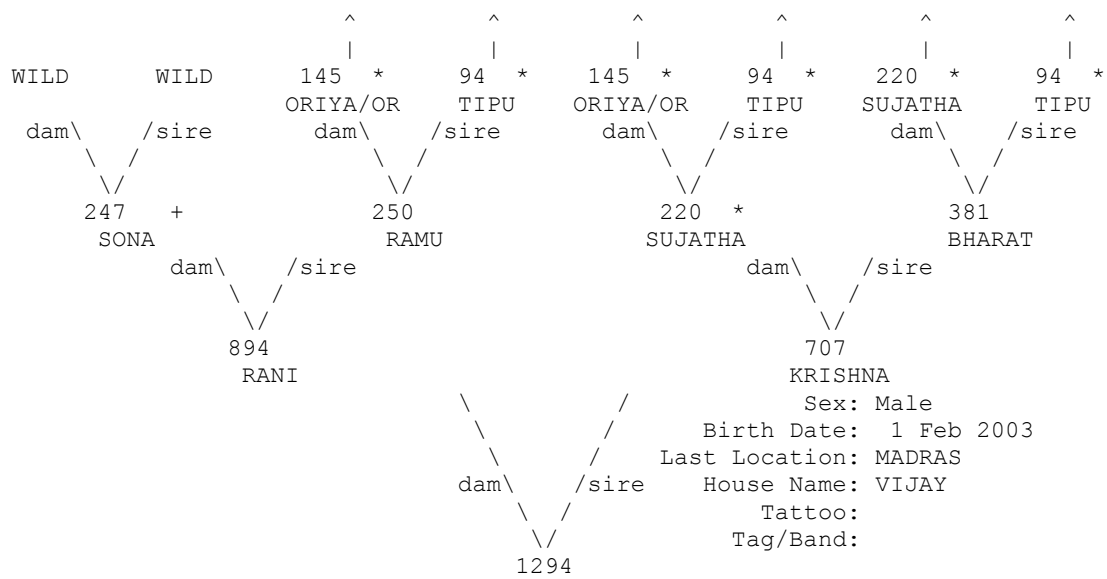

+ Wild-caught... * Appear more than once...
 ^ Pedigree continues beyond top of page...

=====
 Taxon Name: PANTHERA TIGRIS Studbook Number: 1299
 =====

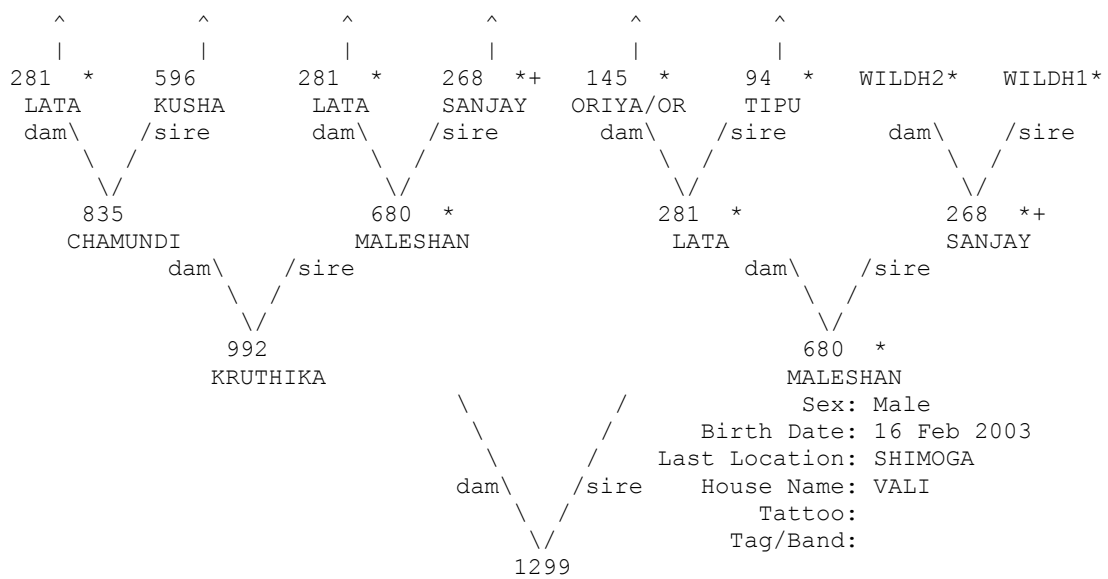

+ Wild-caught... * Appear more than once...
 ^ Pedigree continues beyond top of page...

=====
 Taxon Name: PANTHERA TIGRIS Studbook Number: 1300
 =====

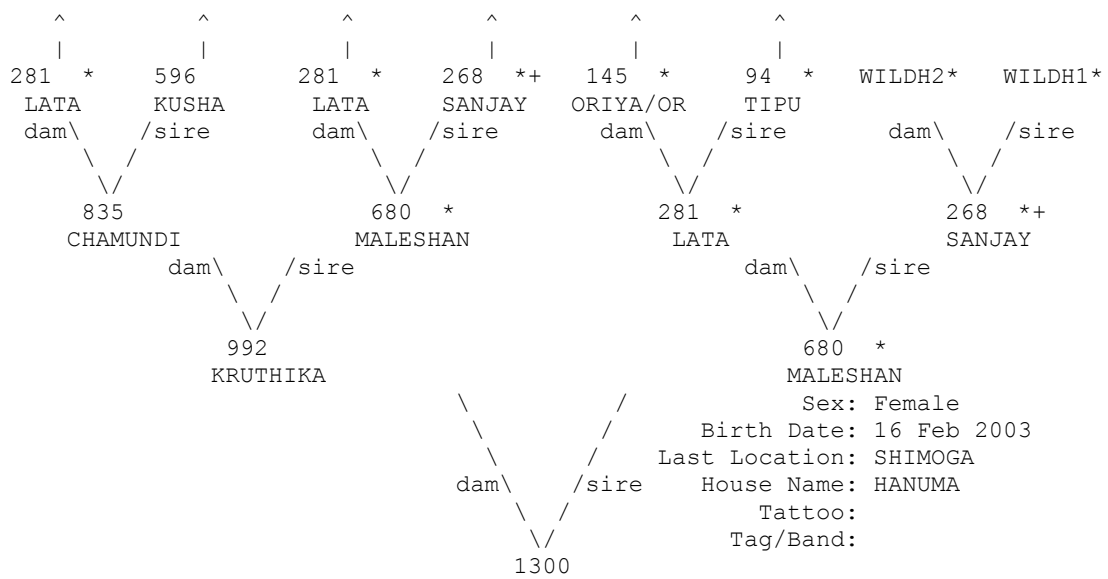

+ Wild-caught... * Appear more than once...
 ^ Pedigree continues beyond top of page...

=====
 Taxon Name: PANTHERA TIGRIS Studbook Number: 1301
 =====

UNK

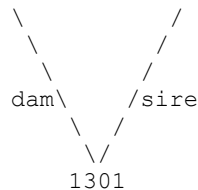

UNK
 Sex: Female
 Birth Date: 11 Apr 2003
 Last Location: SEPAHIJAL (dead)
 House Name: CHILLI
 Tattoo:
 Tag/Band:

=====
 Taxon Name: PANTHERA TIGRIS Studbook Number: 1302
 =====

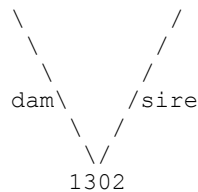
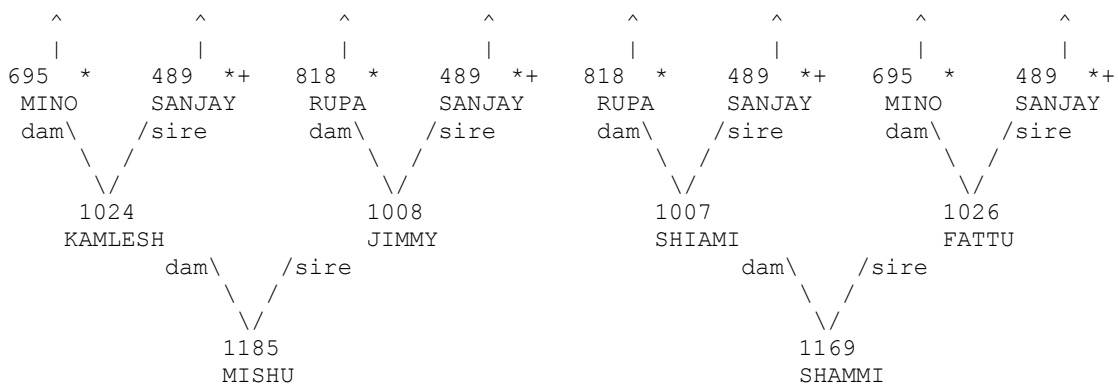

UNK
 Sex: Female
 Birth Date: 11 Apr 2003
 Last Location: CHATBIR Z
 House Name: CHORNI
 Tattoo:
 Tag/Band:

+ Wild-caught... * Appear more than once...
 ^ Pedigree continues beyond top of page...

=====
 Taxon Name: PANTHERA TIGRIS Studbook Number: 1303
 =====

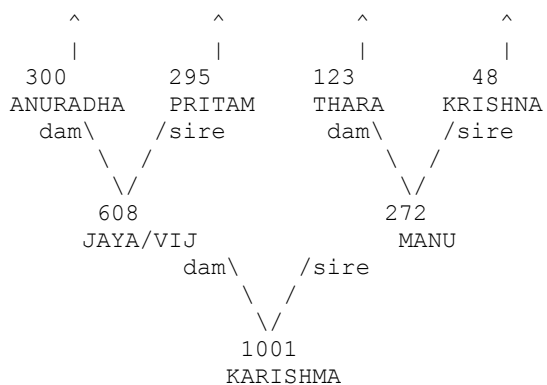

UNK UNK
 dam\ /sire
 \ /
 V
 538
 RAJA

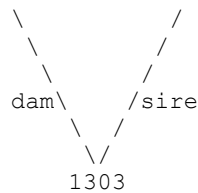

Sex: Male
 Birth Date: 11 May 2003
 Last Location: TRICHUR
 House Name:
 Tattoo:
 Tag/Band:

* Appear more than once...
 ^ Pedigree continues beyond top of page...

=====
 Taxon Name: PANTHERA TIGRIS Studbook Number: 1304
 =====

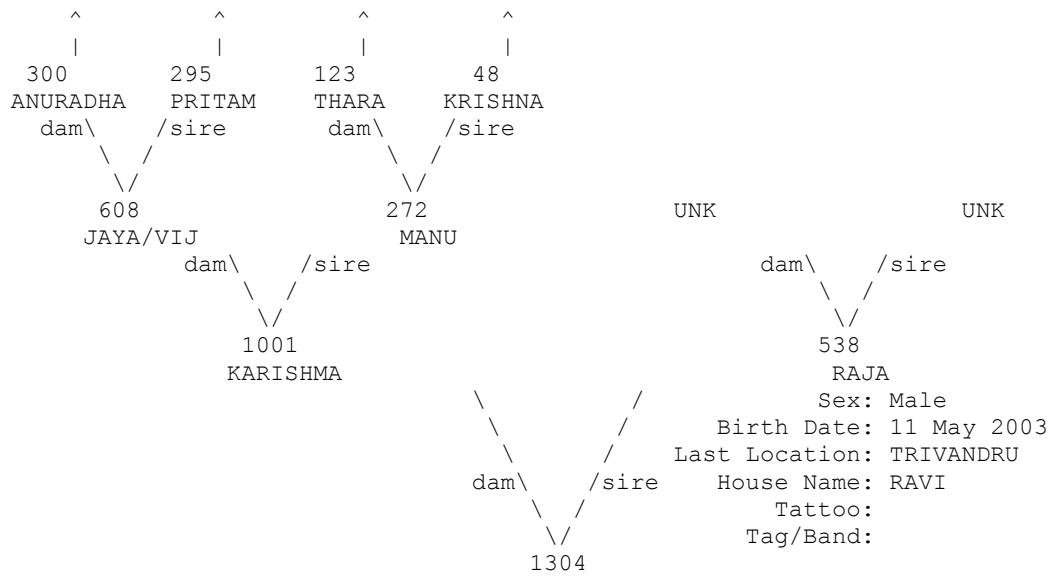

* Appear more than once...
 ^ Pedigree continues beyond top of page...

=====
 Taxon Name: PANTHERA TIGRIS Studbook Number: 1305
 =====

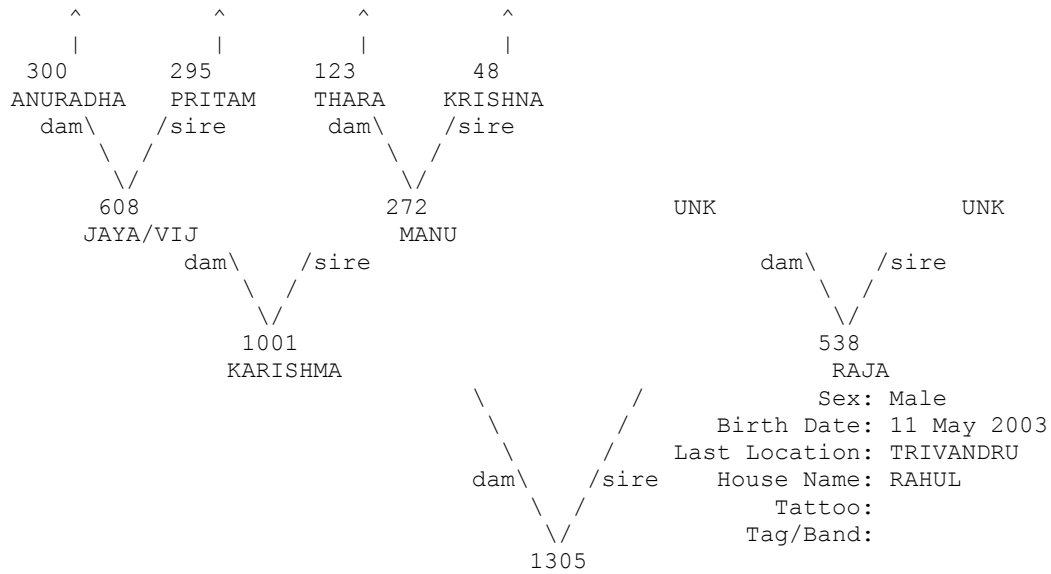

* Appear more than once...
 ^ Pedigree continues beyond top of page...

=====
 Taxon Name: PANTHERA TIGRIS Studbook Number: 1306
 =====

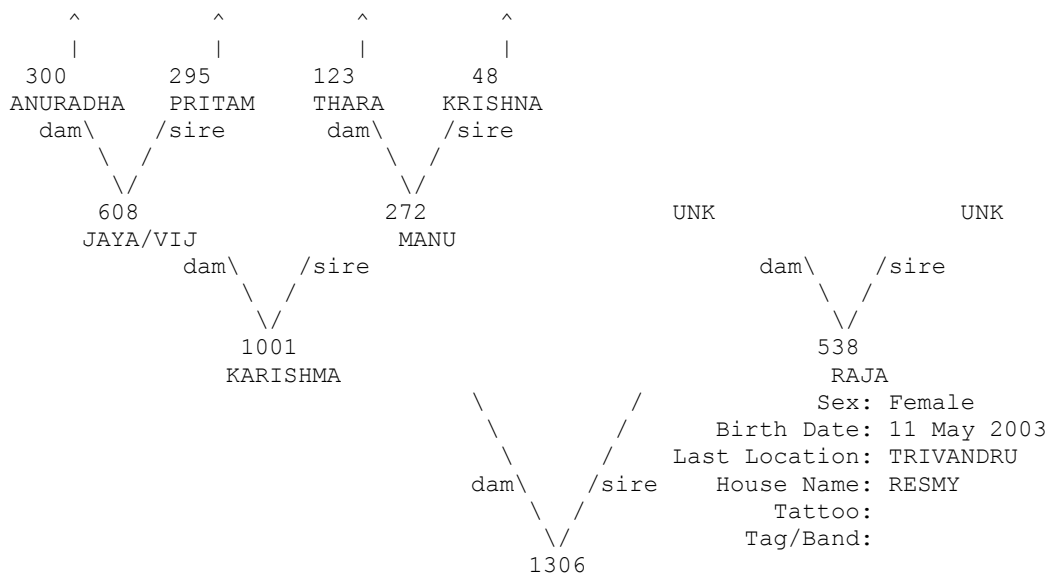

* Appear more than once...
 ^ Pedigree continues beyond top of page...

=====
 Taxon Name: PANTHERA TIGRIS Studbook Number: 1307
 =====

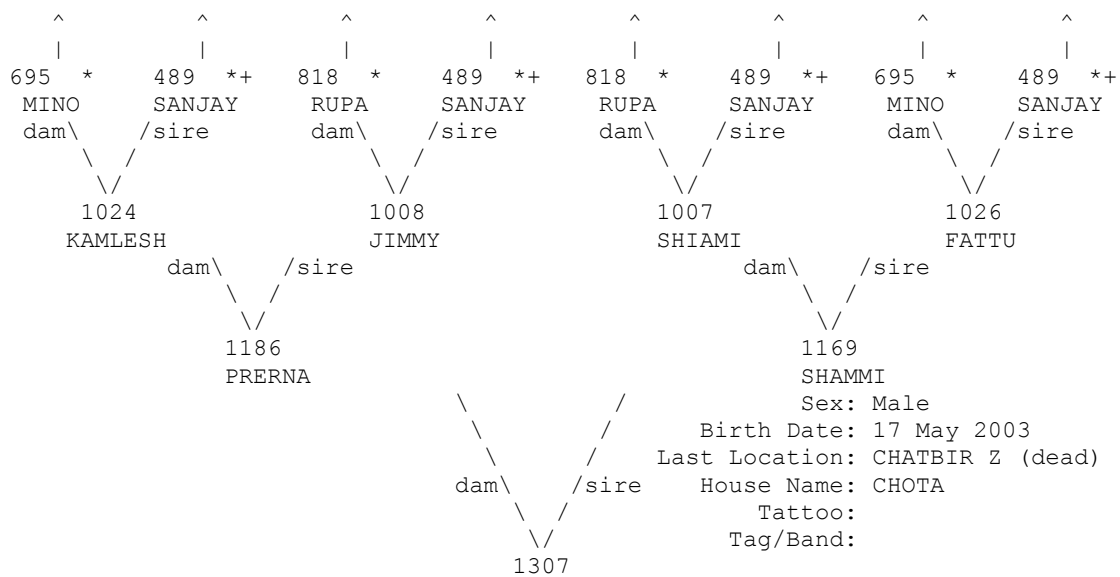

+ Wild-caught... * Appear more than once...
 ^ Pedigree continues beyond top of page...

=====
 Taxon Name: PANTHERA TIGRIS Studbook Number: 1308
 =====

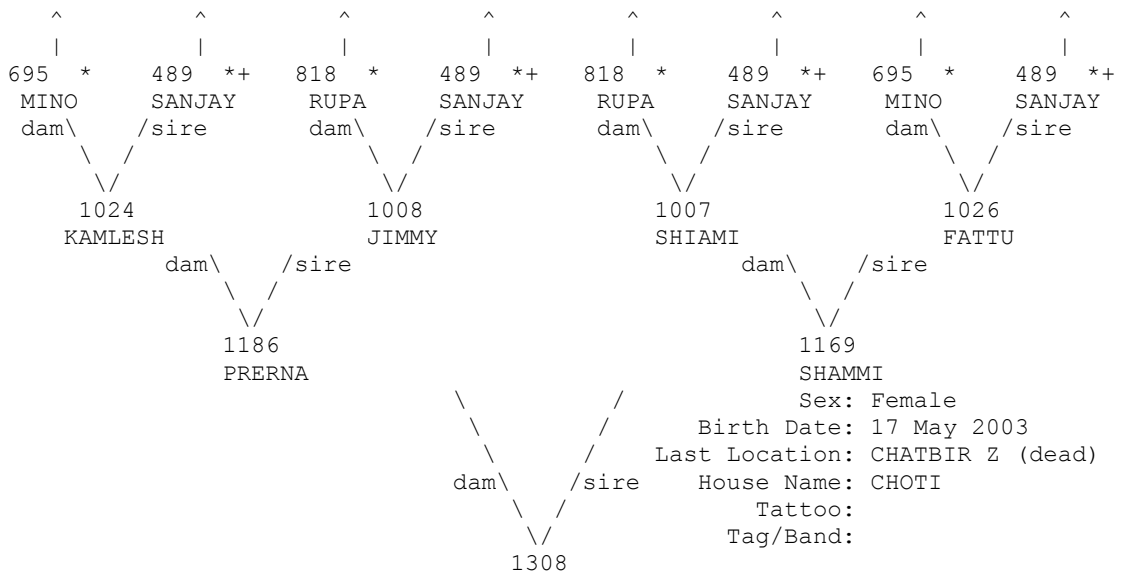

+ Wild-caught... * Appear more than once...
 ^ Pedigree continues beyond top of page...

=====
 Taxon Name: PANTHERA TIGRIS Studbook Number: 1309
 =====

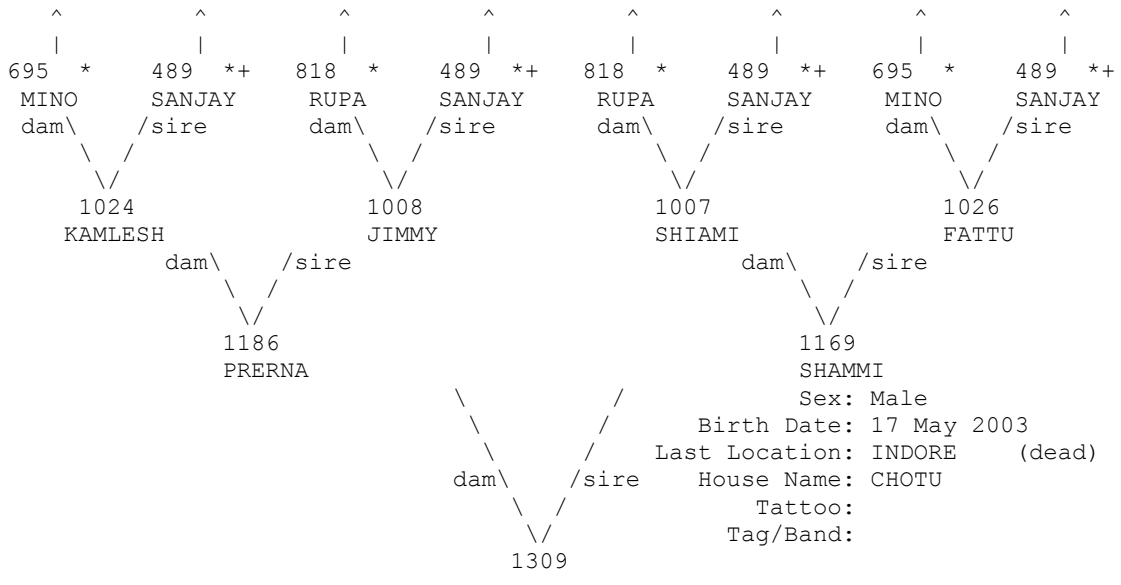

+ Wild-caught... * Appear more than once...
 ^ Pedigree continues beyond top of page...

=====
 Taxon Name: PANTHERA TIGRIS Studbook Number: 1313
 =====

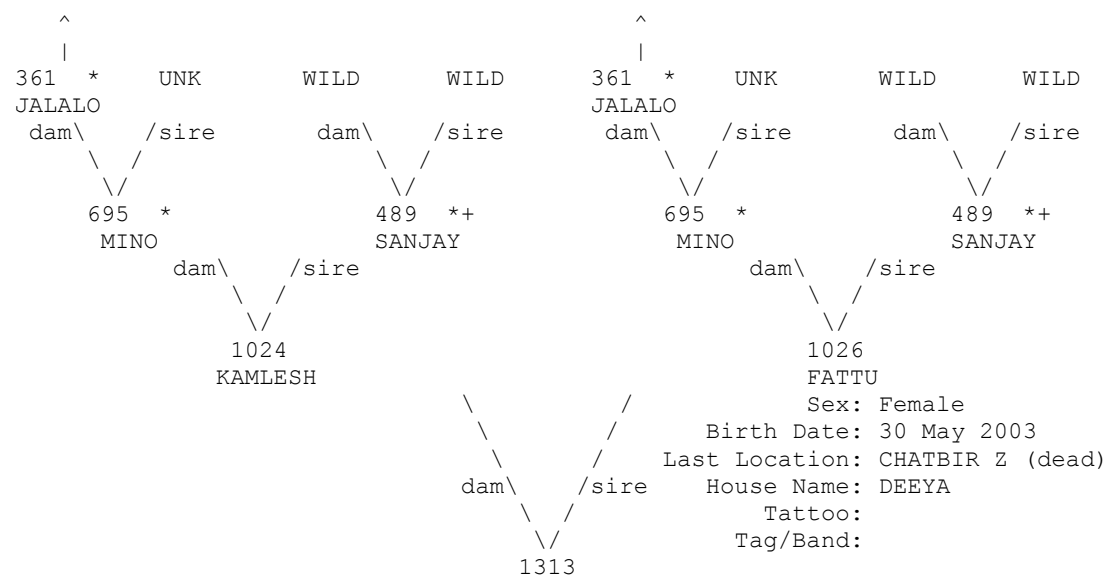

+ Wild-caught... * Appear more than once...
 ^ Pedigree continues beyond top of page...

=====
 Taxon Name: PANTHERA TIGRIS Studbook Number: 1314
 =====

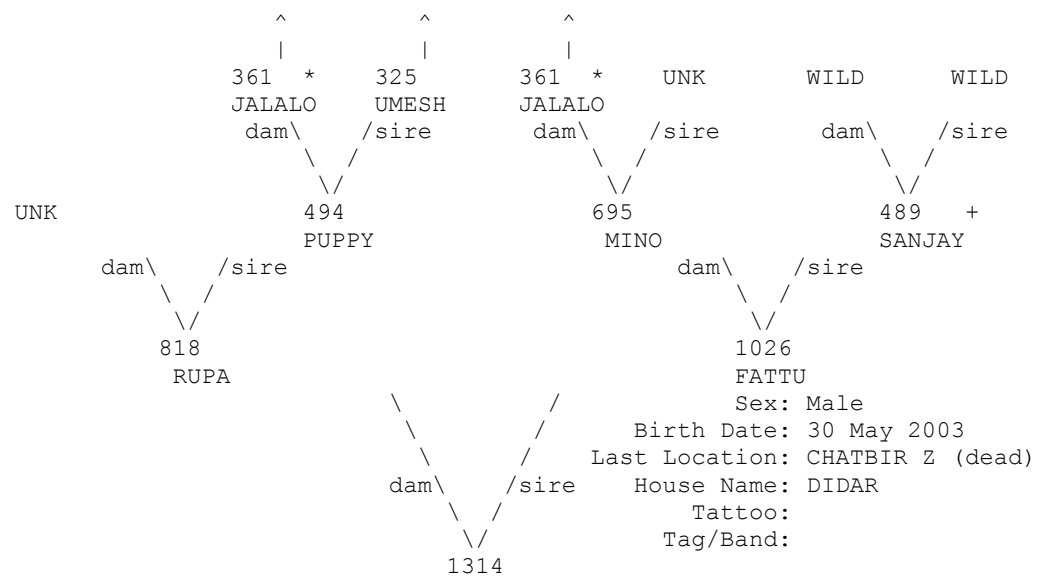

+ Wild-caught... * Appear more than once...
 ^ Pedigree continues beyond top of page...

=====
 Taxon Name: PANTHERA TIGRIS Studbook Number: 1315
 =====

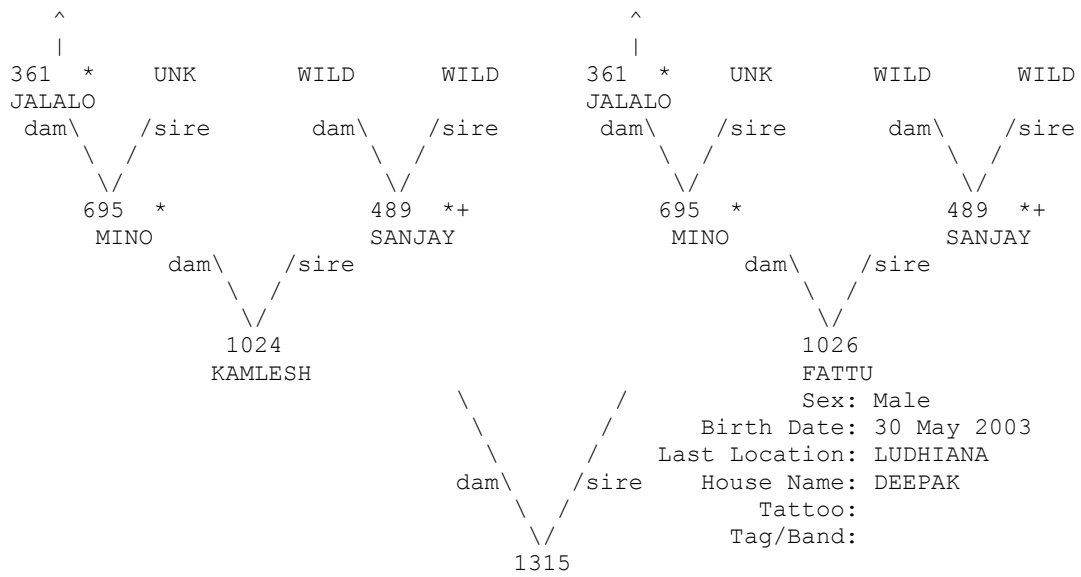

+ Wild-caught... * Appear more than once...
 ^ Pedigree continues beyond top of page...

=====
 Taxon Name: PANTHERA TIGRIS Studbook Number: 1316
 =====

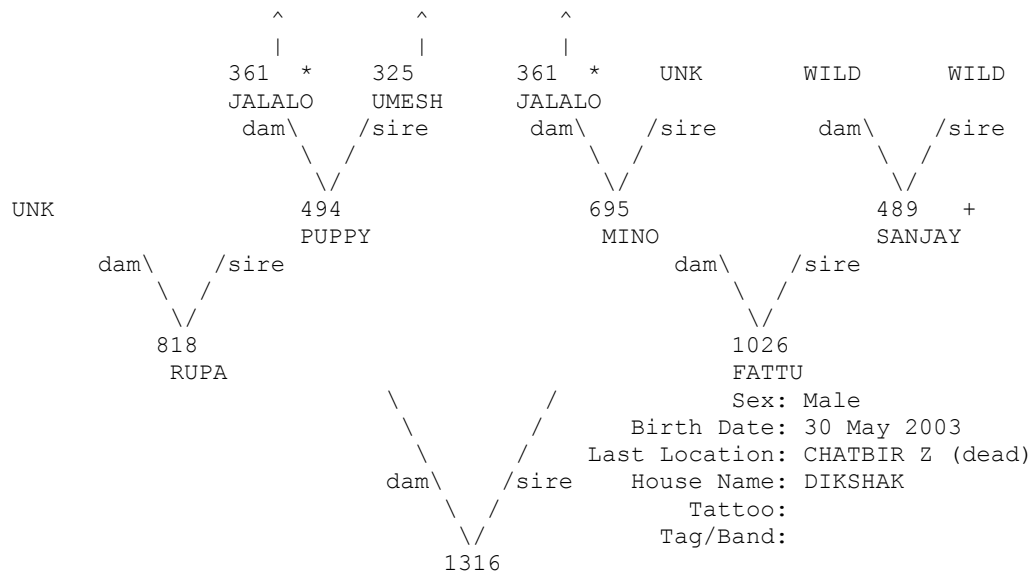

+ Wild-caught... * Appear more than once...
 ^ Pedigree continues beyond top of page...

=====
 Taxon Name: PANTHERA TIGRIS Studbook Number: 1317
 =====

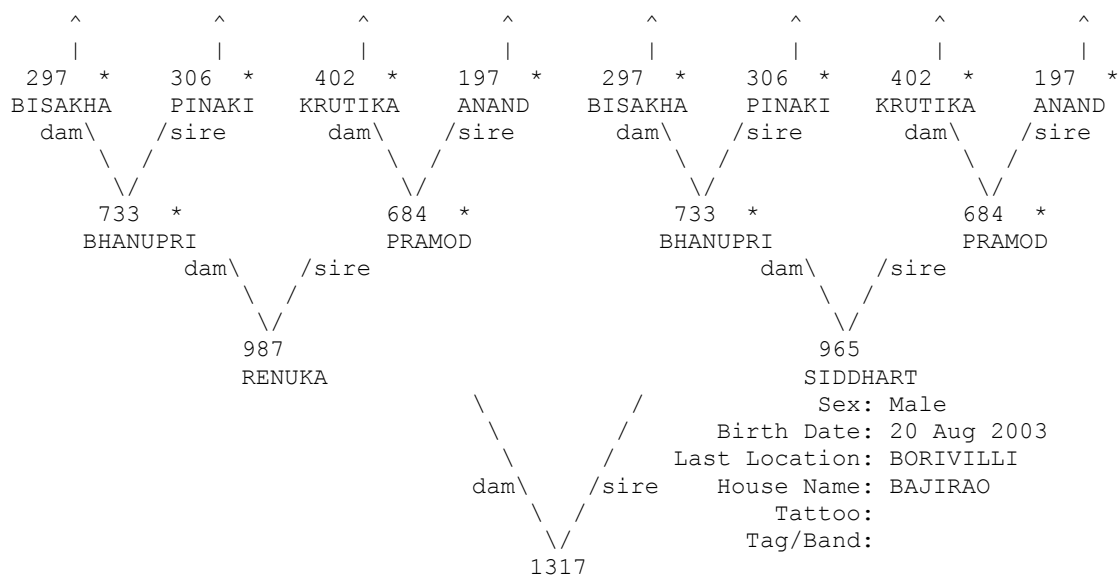

* Appear more than once...
 ^ Pedigree continues beyond top of page...

=====
 Taxon Name: PANTHERA TIGRIS Studbook Number: 1318
 =====

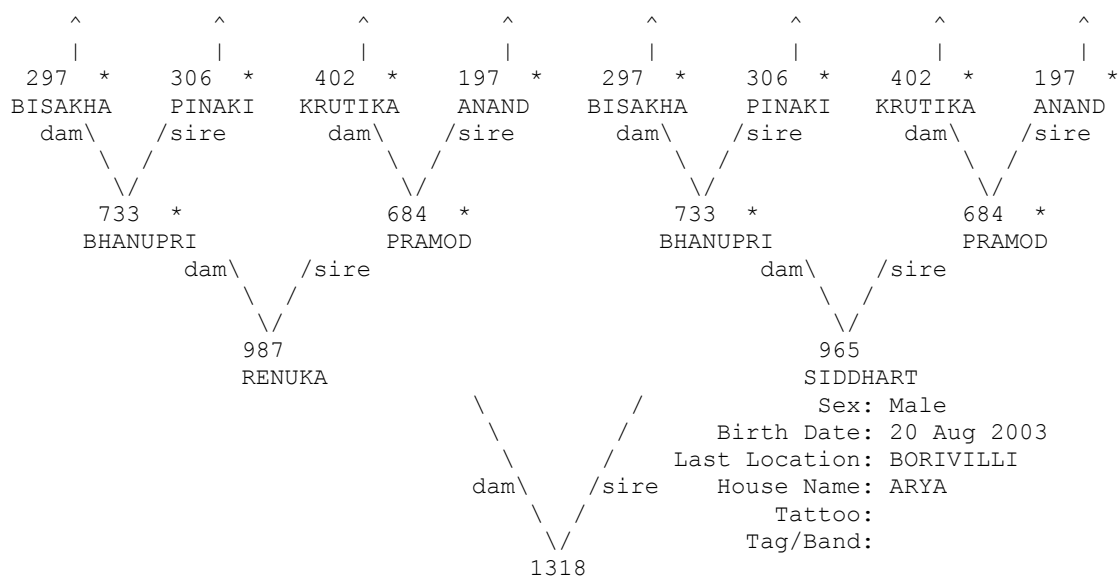

* Appear more than once...
 ^ Pedigree continues beyond top of page...

=====
 Taxon Name: PANTHERA TIGRIS Studbook Number: 1319
 =====

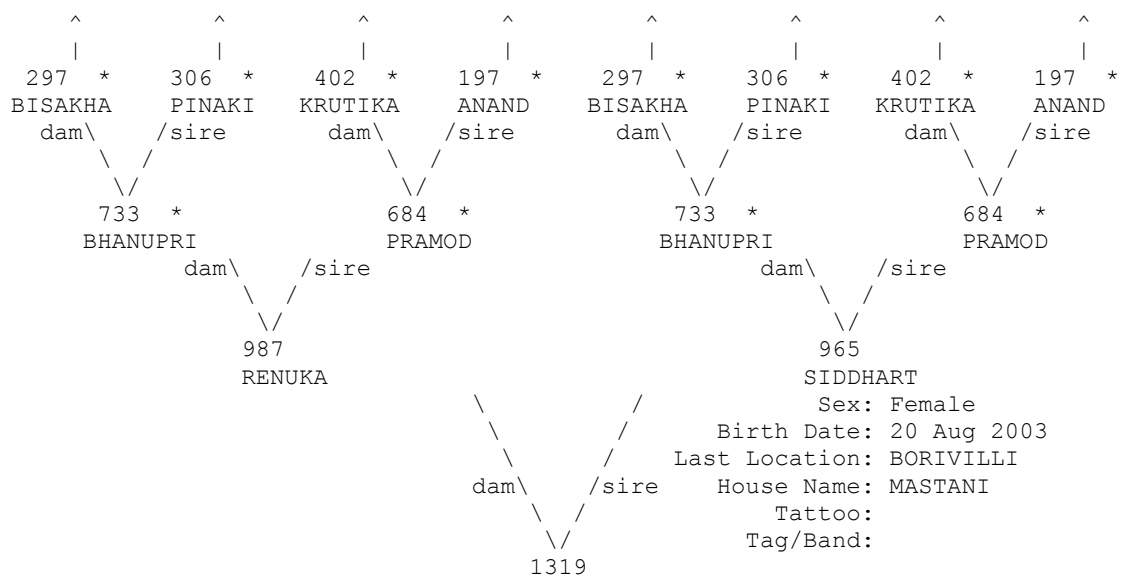

* Appear more than once...
 ^ Pedigree continues beyond top of page...

=====
 Taxon Name: PANTHERA TIGRIS Studbook Number: 1320
 =====

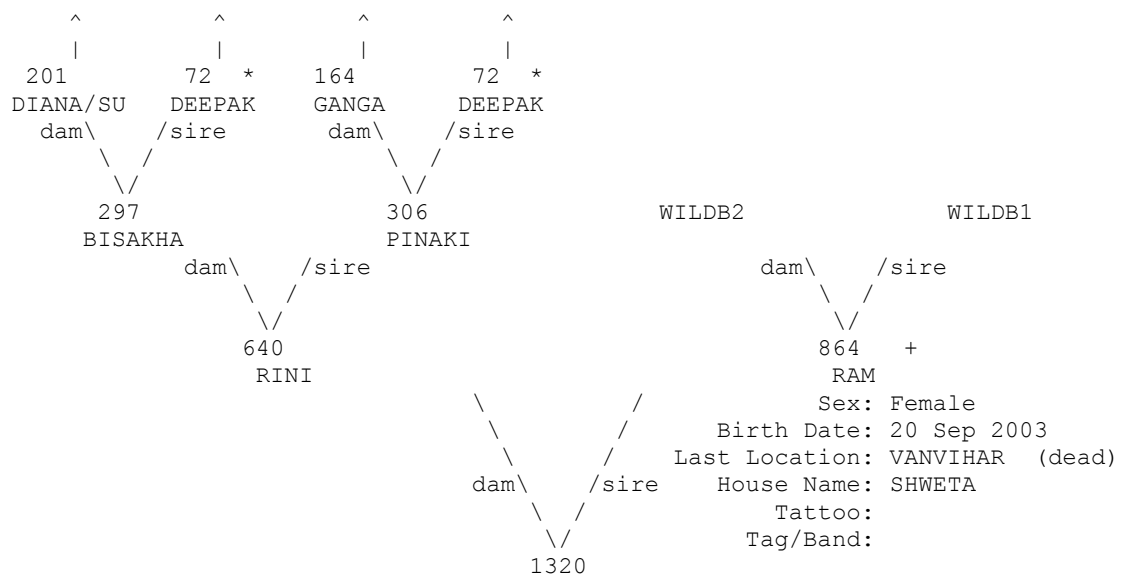

+ Wild-caught... * Appear more than once...
 ^ Pedigree continues beyond top of page...

=====
 Taxon Name: PANTHERA TIGRIS Studbook Number: 1321
 =====

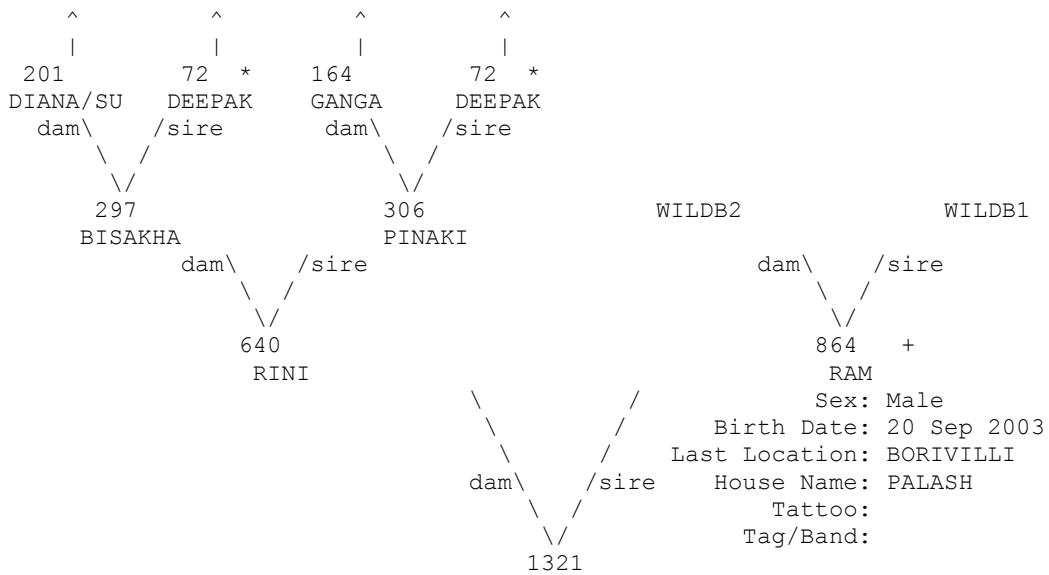

+ Wild-caught... * Appear more than once...
 ^ Pedigree continues beyond top of page...

=====
 Taxon Name: PANTHERA TIGRIS Studbook Number: 1322
 =====

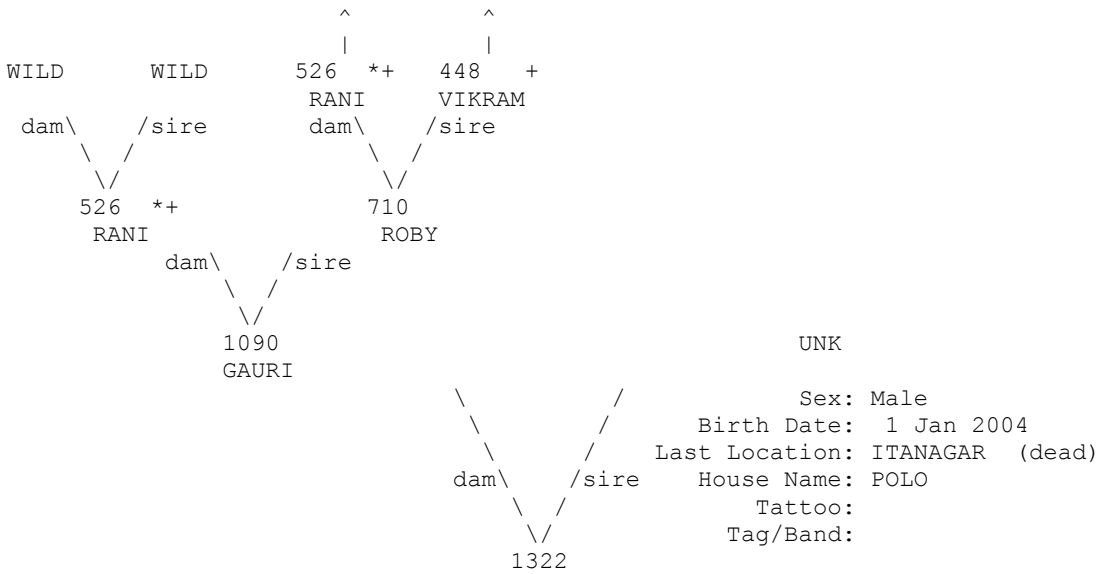

+ Wild-caught... * Appear more than once...
 ^ Pedigree continues beyond top of page...

=====
 Taxon Name: PANTHERA TIGRIS Studbook Number: 1325
 =====

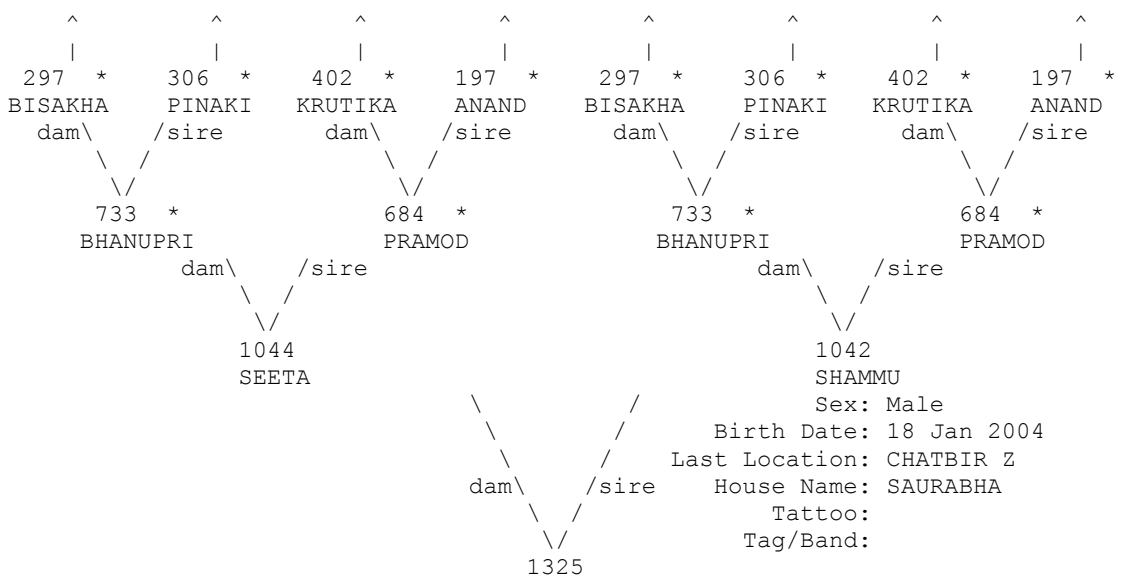

* Appear more than once...
 ^ Pedigree continues beyond top of page...

=====
 Taxon Name: PANTHERA TIGRIS Studbook Number: 1326
 =====

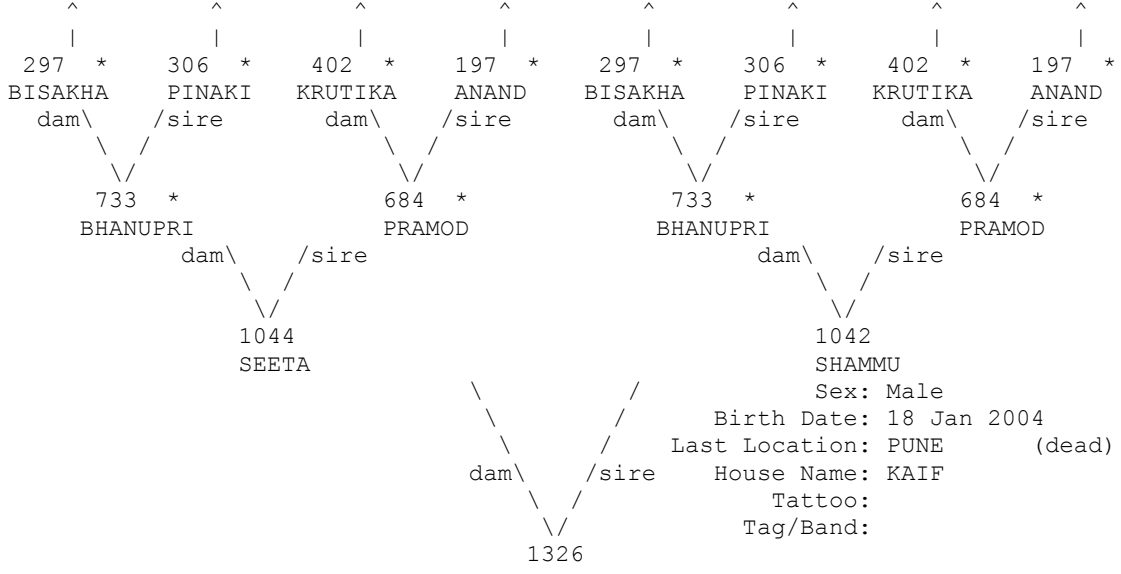

* Appear more than once...
 ^ Pedigree continues beyond top of page...

=====
 Taxon Name: PANTHERA TIGRIS Studbook Number: 1327
 =====

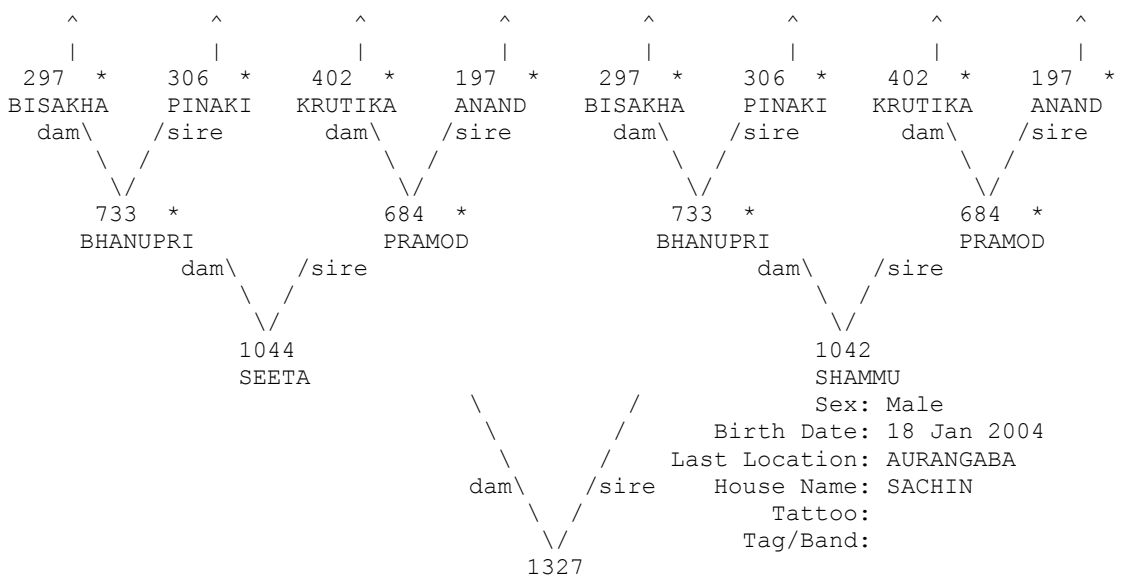

* Appear more than once...
 ^ Pedigree continues beyond top of page...

=====
 Taxon Name: PANTHERA TIGRIS Studbook Number: 1328
 =====

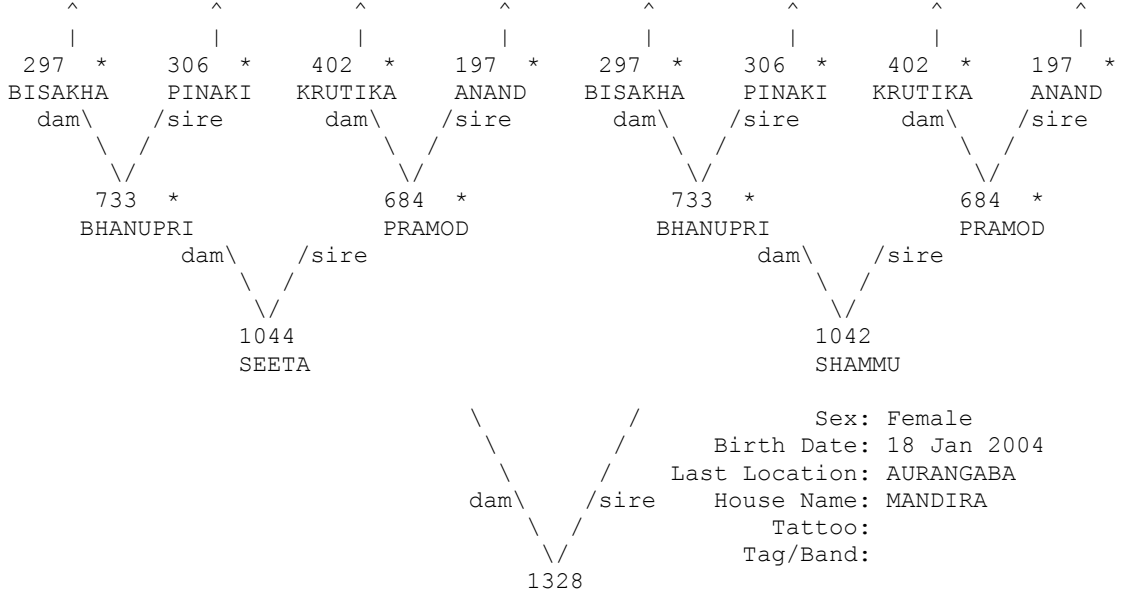

* Appear more than once...
 ^ Pedigree continues beyond top of page...

=====
 Taxon Name: PANTHERA TIGRIS Studbook Number: 1332
 =====

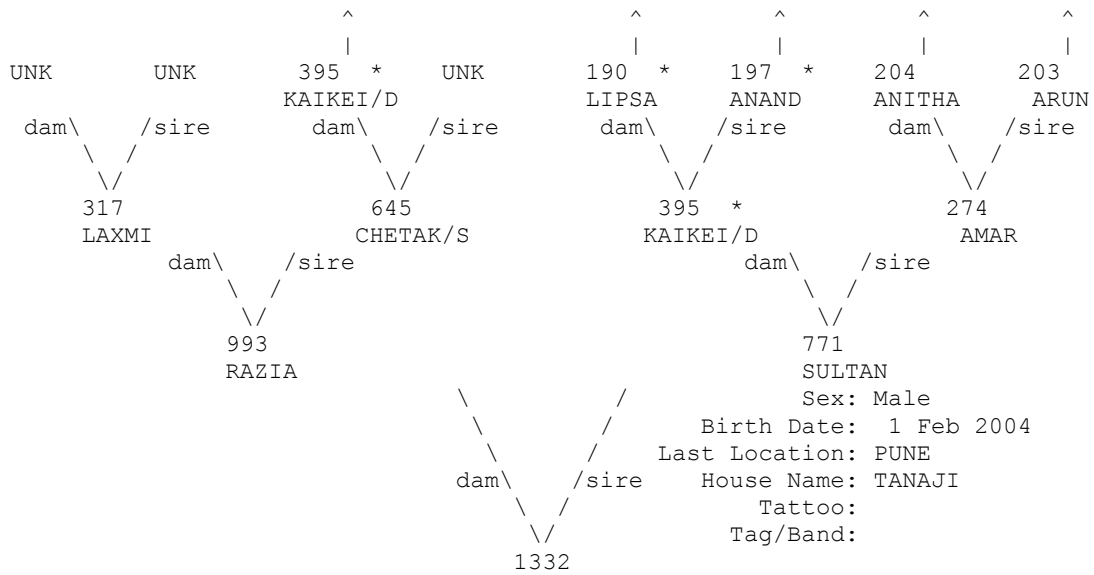

* Appear more than once...
 ^ Pedigree continues beyond top of page...

=====
 Taxon Name: PANTHERA TIGRIS Studbook Number: 1333
 =====

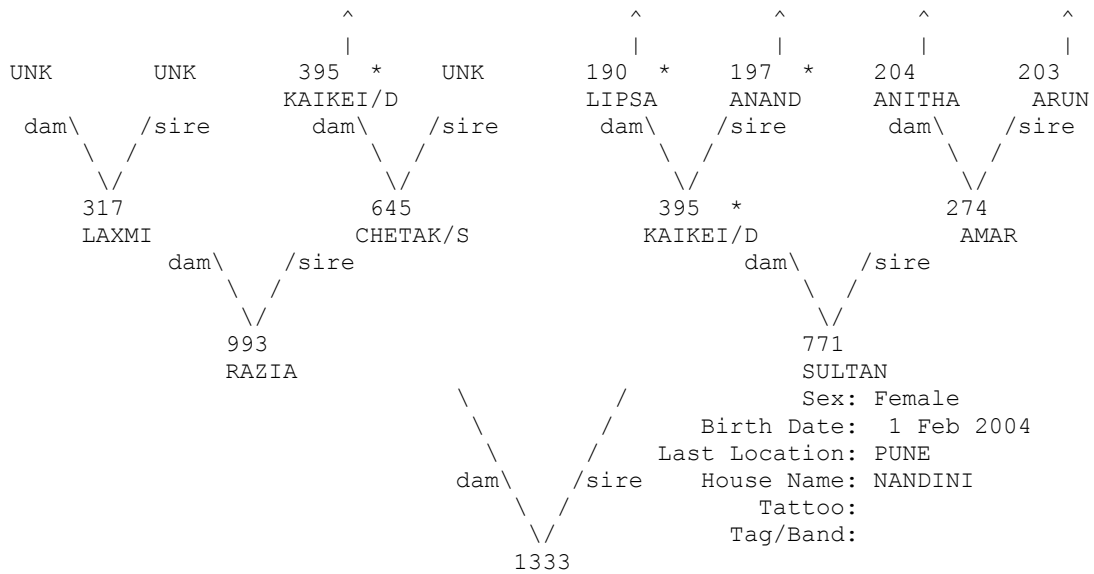

* Appear more than once...
 ^ Pedigree continues beyond top of page...

=====
 Taxon Name: PANTHERA TIGRIS Studbook Number: 1334
 =====

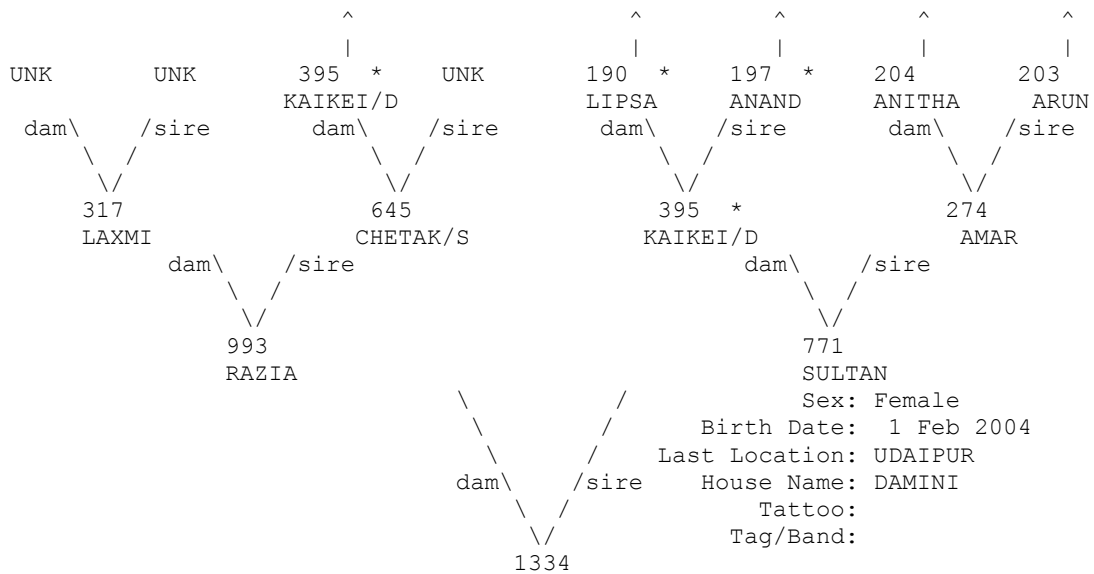

* Appear more than once...
 ^ Pedigree continues beyond top of page...

=====
 Taxon Name: PANTHERA TIGRIS Studbook Number: 1335
 =====

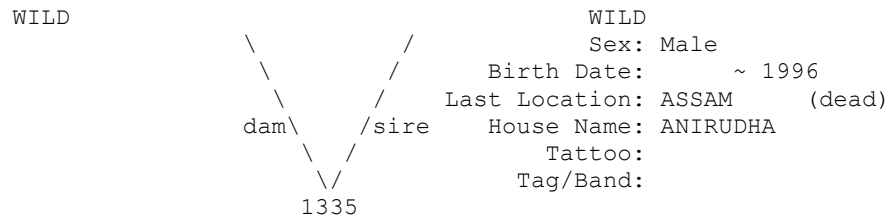

=====
 Taxon Name: PANTHERA TIGRIS Studbook Number: 1336
 =====

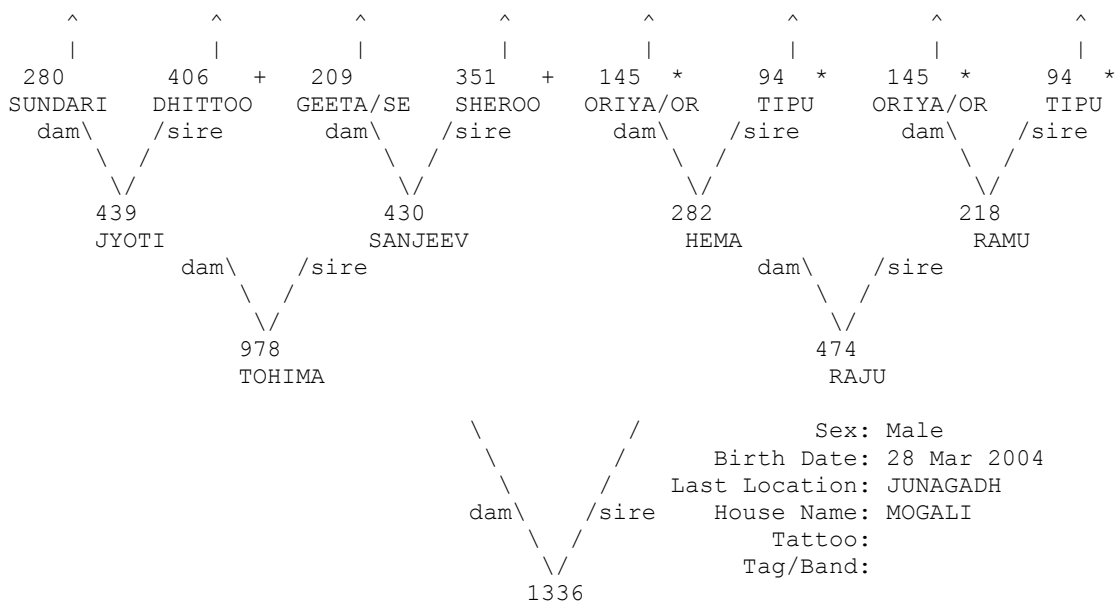

+ Wild-caught... * Appear more than once...
 ^ Pedigree continues beyond top of page...

=====
 Taxon Name: PANTHERA TIGRIS Studbook Number: 1337
 =====

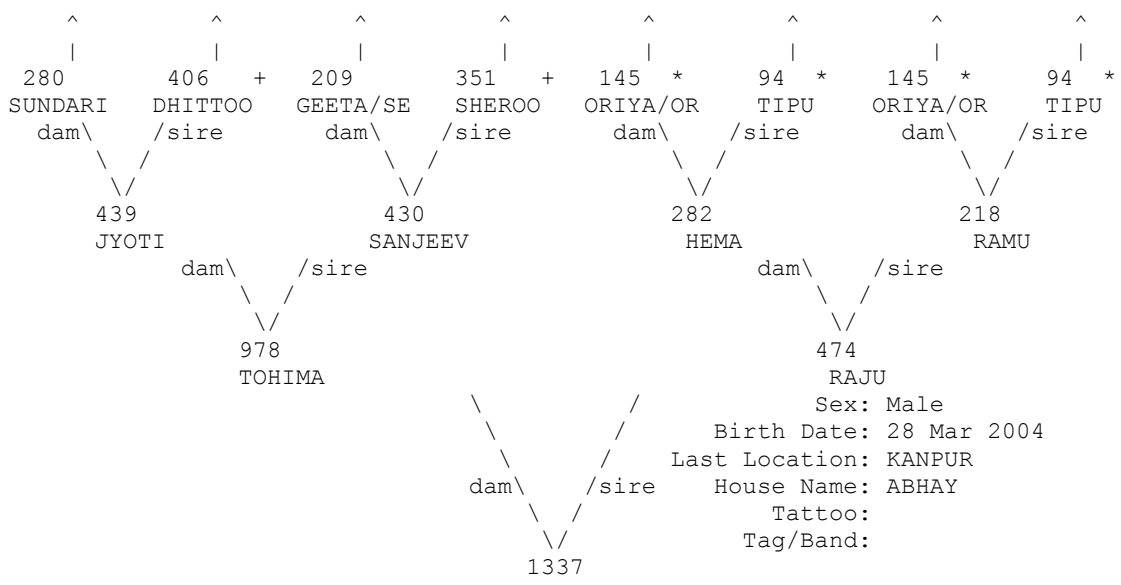

+ Wild-caught... * Appear more than once...
 ^ Pedigree continues beyond top of page...

=====
 Taxon Name: PANTHERA TIGRIS Studbook Number: 1338
 =====

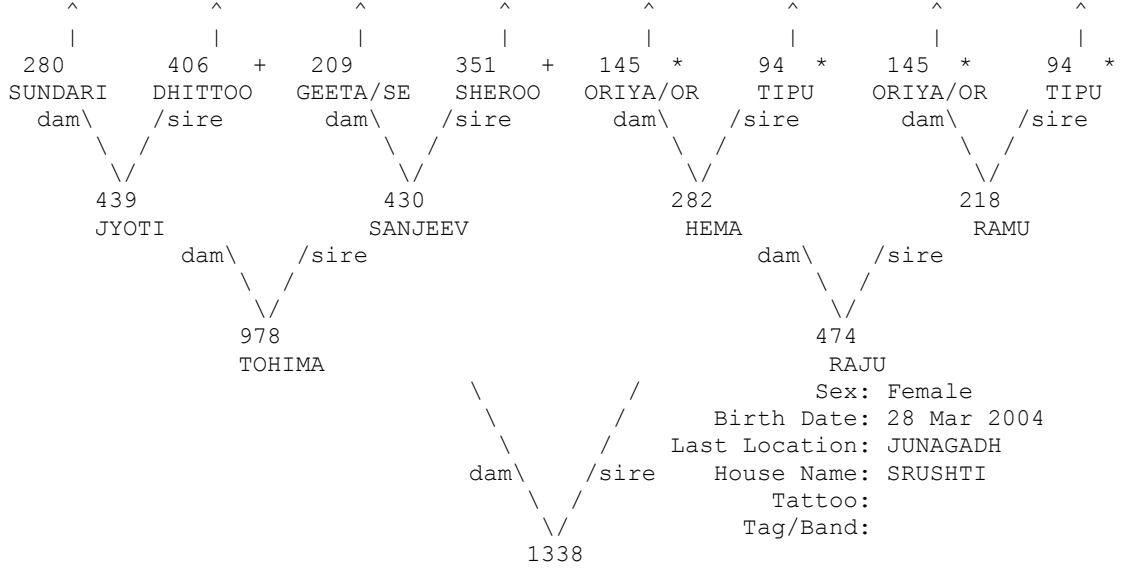

+ Wild-caught... * Appear more than once...
 ^ Pedigree continues beyond top of page...

=====
 Taxon Name: PANTHERA TIGRIS Studbook Number: 1339
 =====

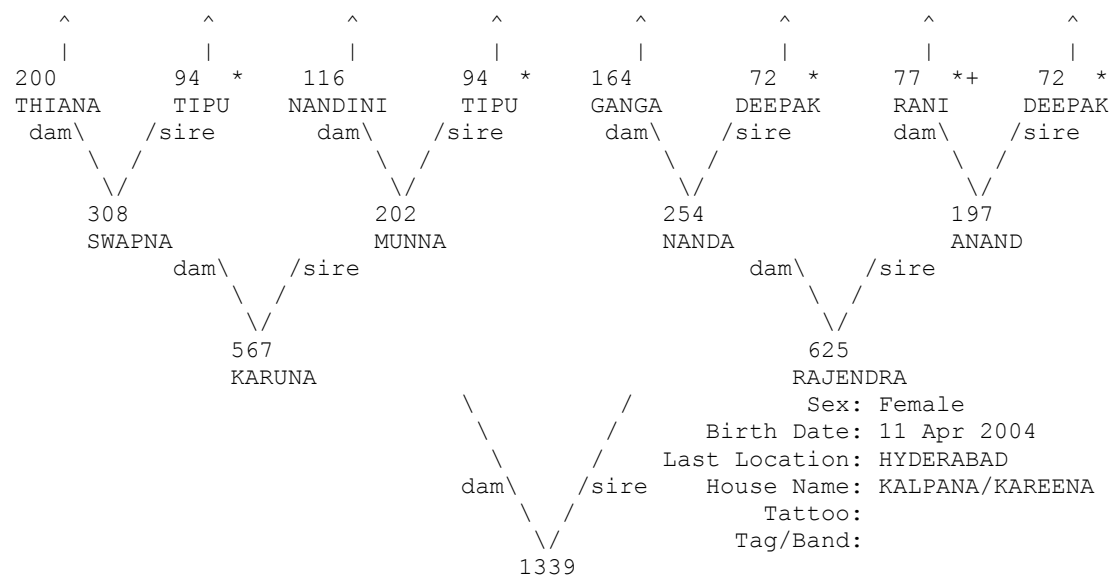

+ Wild-caught... * Appear more than once...
 ^ Pedigree continues beyond top of page...

=====
 Taxon Name: PANTHERA TIGRIS Studbook Number: 1340
 =====

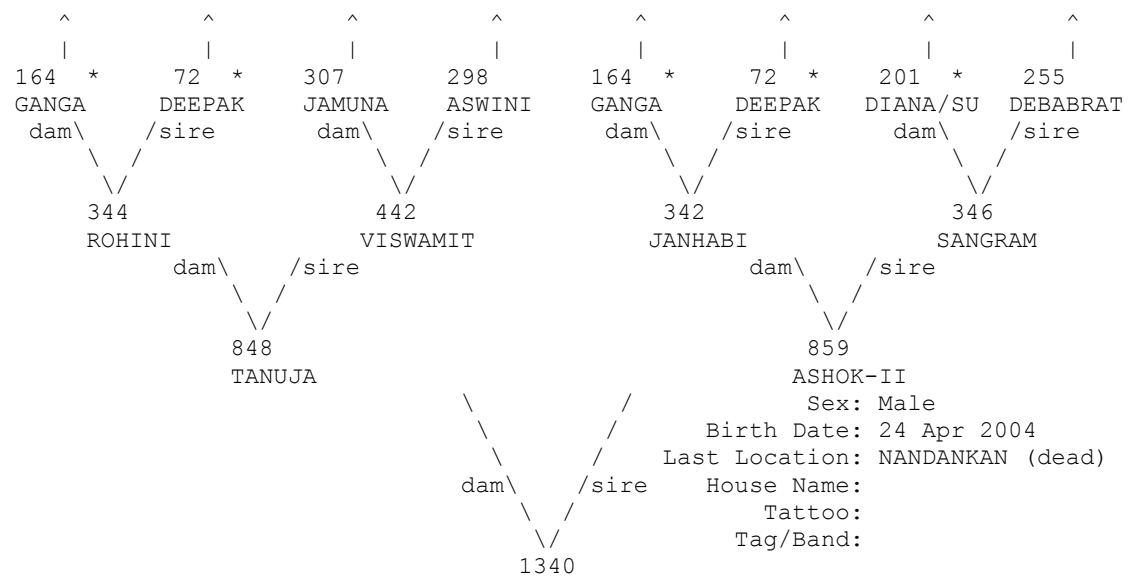

* Appear more than once...
 ^ Pedigree continues beyond top of page...

=====
 Taxon Name: PANTHERA TIGRIS Studbook Number: 1341
 =====

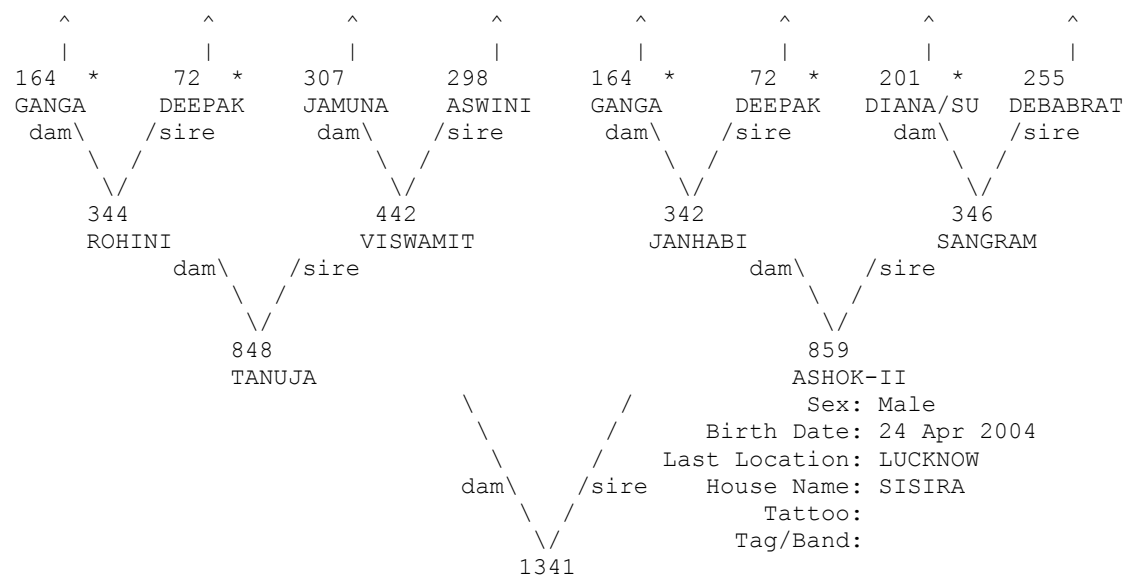

* Appear more than once...
 ^ Pedigree continues beyond top of page...

=====
 Taxon Name: PANTHERA TIGRIS Studbook Number: 1342
 =====

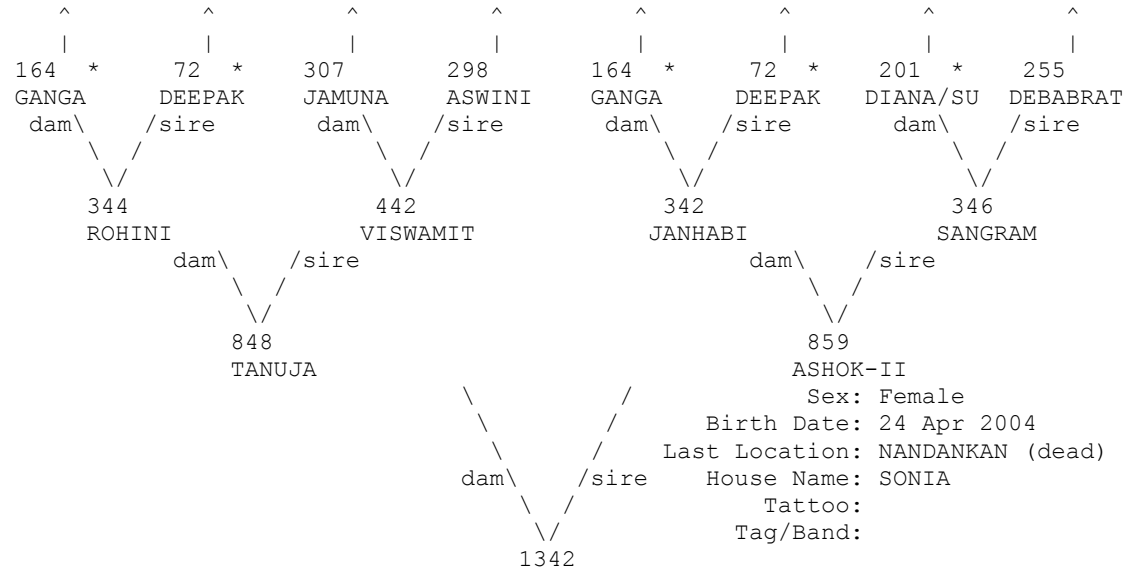

* Appear more than once...
 ^ Pedigree continues beyond top of page...

=====
 Taxon Name: PANTHERA TIGRIS Studbook Number: 1346
 =====

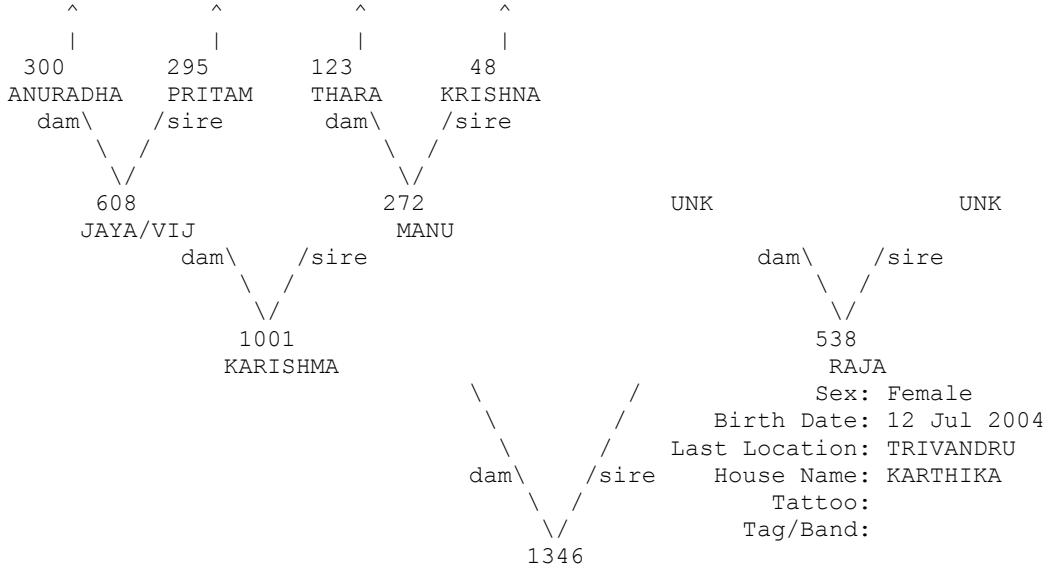

* Appear more than once...
 ^ Pedigree continues beyond top of page...

=====
 Taxon Name: PANTHERA TIGRIS Studbook Number: 1347
 =====

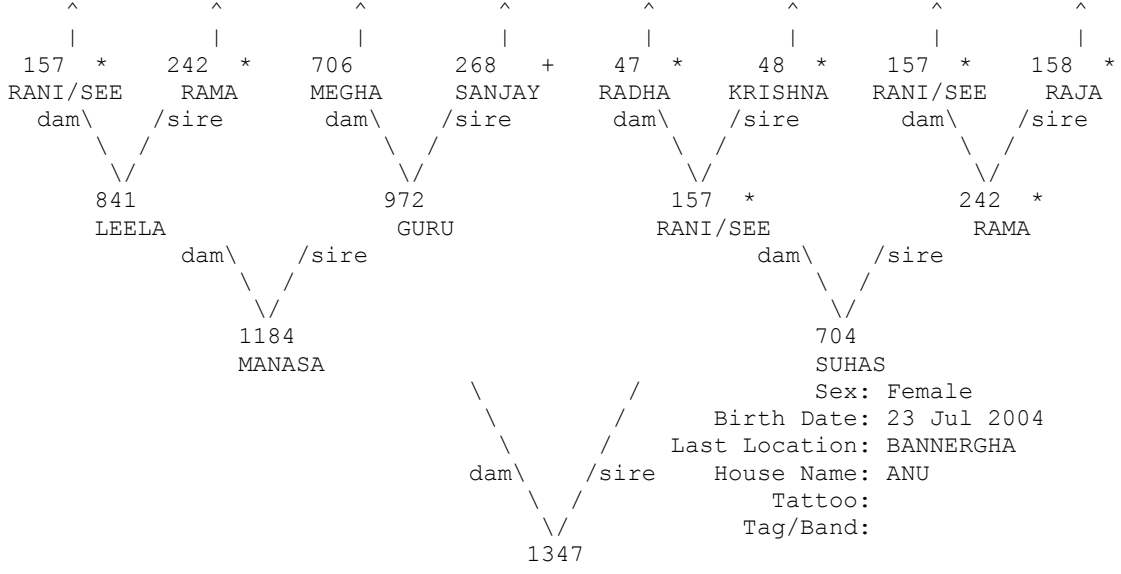

+ Wild-caught... * Appear more than once...
 ^ Pedigree continues beyond top of page...

=====
 Taxon Name: PANTHERA TIGRIS Studbook Number: 1348
 =====

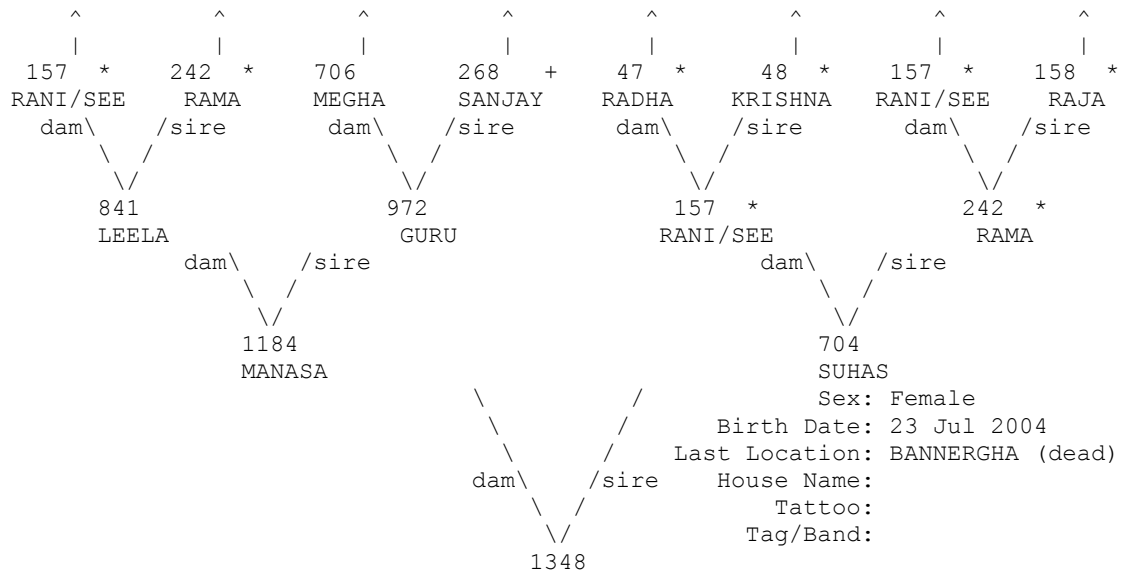

+ Wild-caught... * Appear more than once...
 ^ Pedigree continues beyond top of page...

=====
 Taxon Name: PANTHERA TIGRIS Studbook Number: 1349
 =====

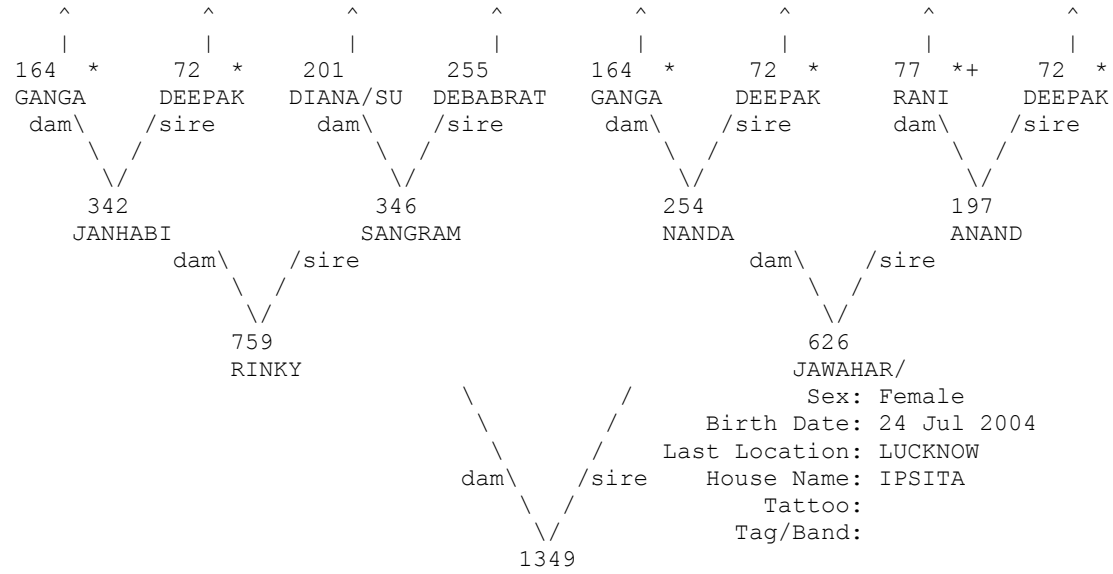

+ Wild-caught... * Appear more than once...
 ^ Pedigree continues beyond top of page...

=====
 Taxon Name: PANTHERA TIGRIS Studbook Number: 1352
 =====

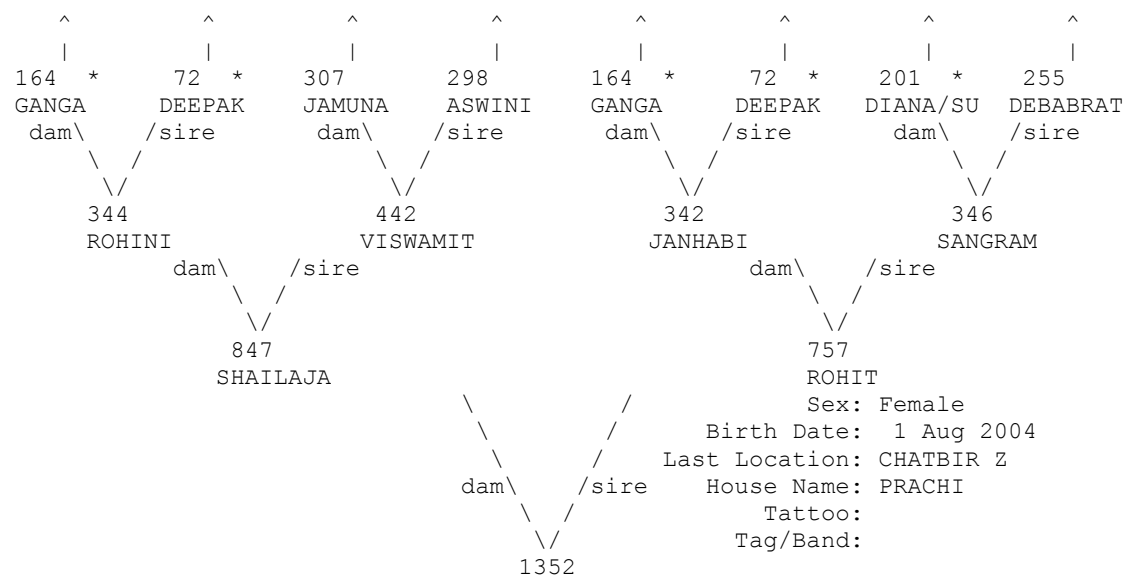

* Appear more than once...
 ^ Pedigree continues beyond top of page...

=====
 Taxon Name: PANTHERA TIGRIS Studbook Number: 1353
 =====

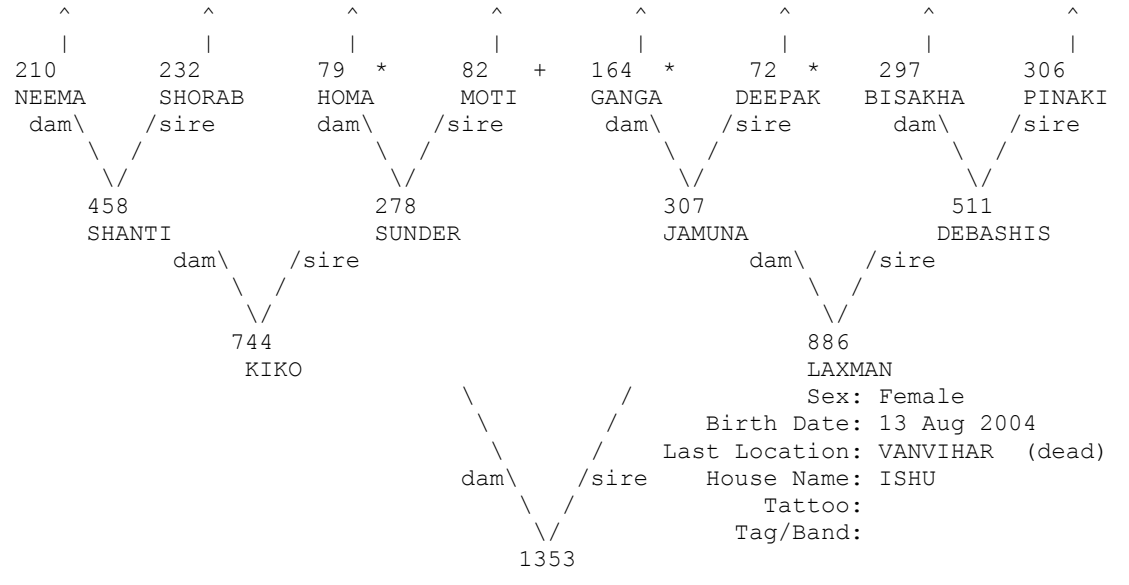

+ Wild-caught... * Appear more than once...
 ^ Pedigree continues beyond top of page...

=====
 Taxon Name: PANTHERA TIGRIS Studbook Number: 1354
 =====

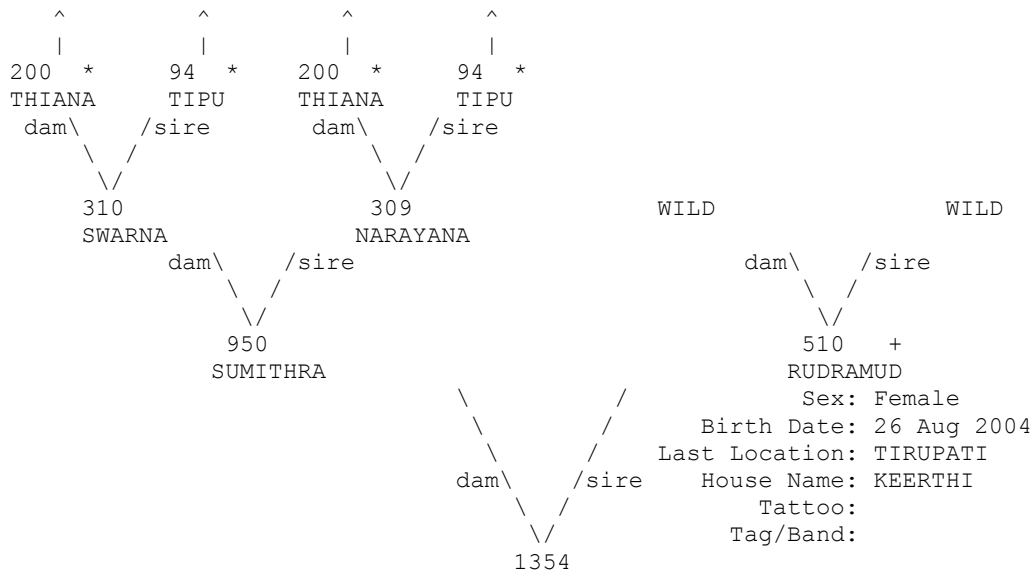

+ Wild-caught... * Appear more than once...
 ^ Pedigree continues beyond top of page...

=====
 Taxon Name: PANTHERA TIGRIS Studbook Number: 1355
 =====

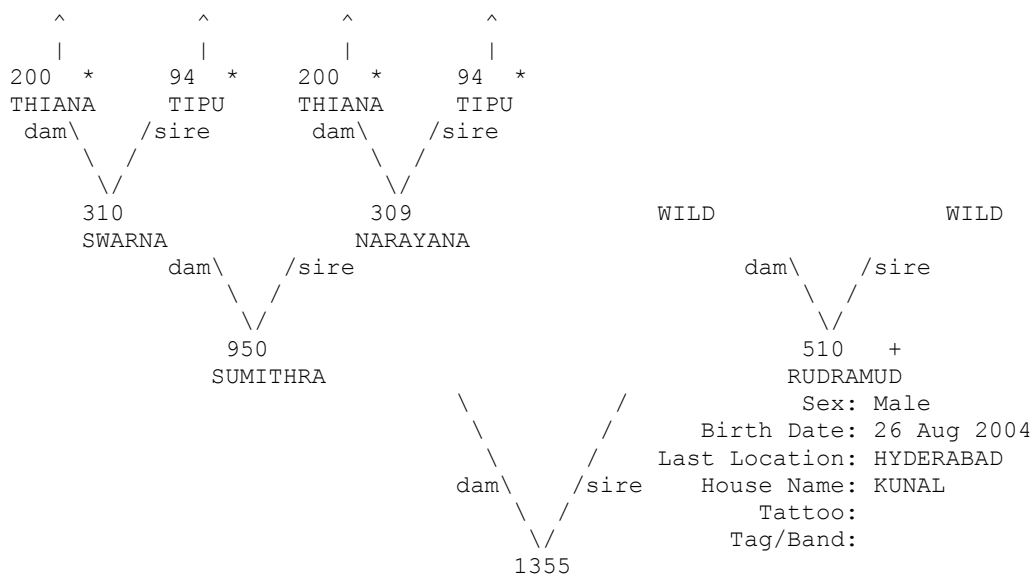

+ Wild-caught... * Appear more than once...
 ^ Pedigree continues beyond top of page...

=====
 Taxon Name: PANTHERA TIGRIS Studbook Number: 1356
 =====

UNK

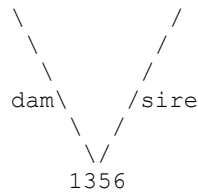

UNK
 Sex: Female
 Birth Date: 28 Aug 2004
 Last Location: VANVIHAR
 House Name: GAURI
 Tattoo:
 Tag/Band:

=====
 Taxon Name: PANTHERA TIGRIS Studbook Number: 1357
 =====

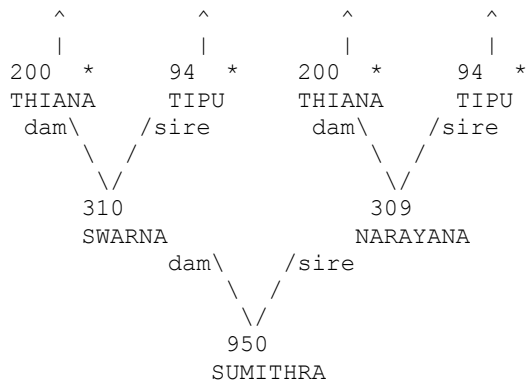

WILD WILD
 dam\ /sire
 510 +
 RUDRAMUD
 Sex: Female
 Birth Date: 28 Aug 2004
 Last Location: VISAKAPAT
 House Name: KUMARI
 Tattoo:
 Tag/Band:

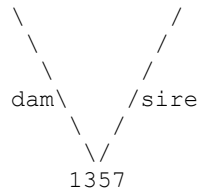

+ Wild-caught... * Appear more than once...
 ^ Pedigree continues beyond top of page...

=====
 Taxon Name: PANTHERA TIGRIS Studbook Number: 1358
 =====

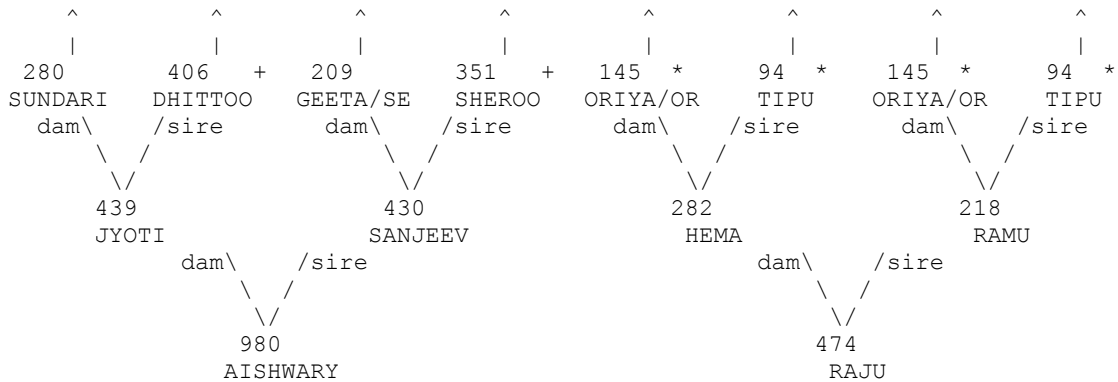

Sex: Male
 Birth Date: 4 Oct 2004
 Last Location: JUNAGADH
 House Name: AMAR
 Tattoo:
 Tag/Band:

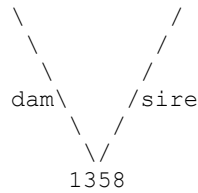

+ Wild-caught... * Appear more than once...
 ^ Pedigree continues beyond top of page...

=====
 Taxon Name: PANTHERA TIGRIS Studbook Number: 1359
 =====

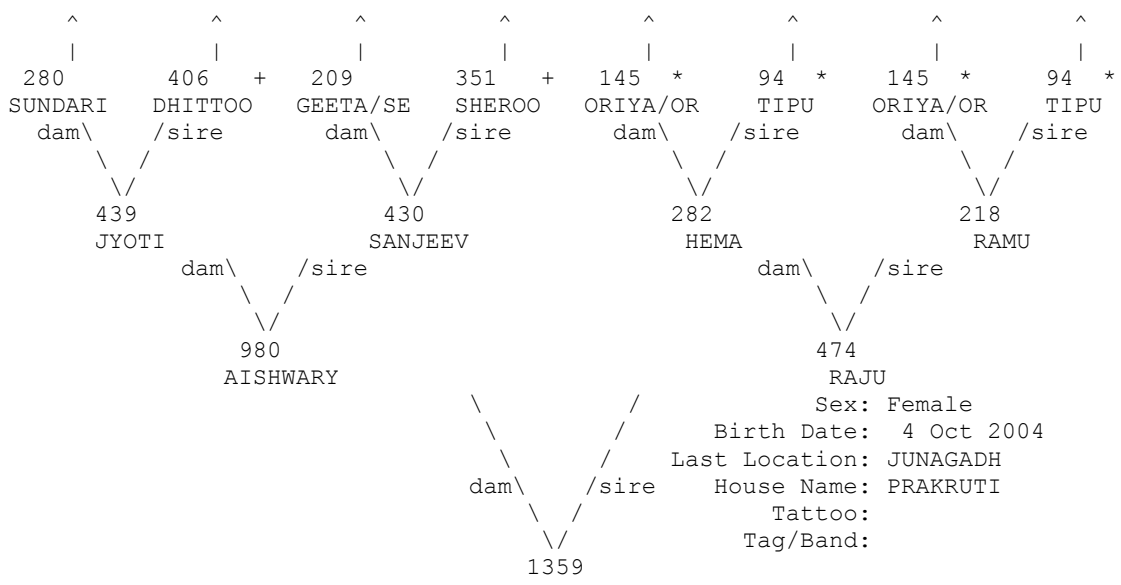

+ Wild-caught... * Appear more than once...
 ^ Pedigree continues beyond top of page...

=====
 Taxon Name: PANTHERA TIGRIS Studbook Number: 1360
 =====

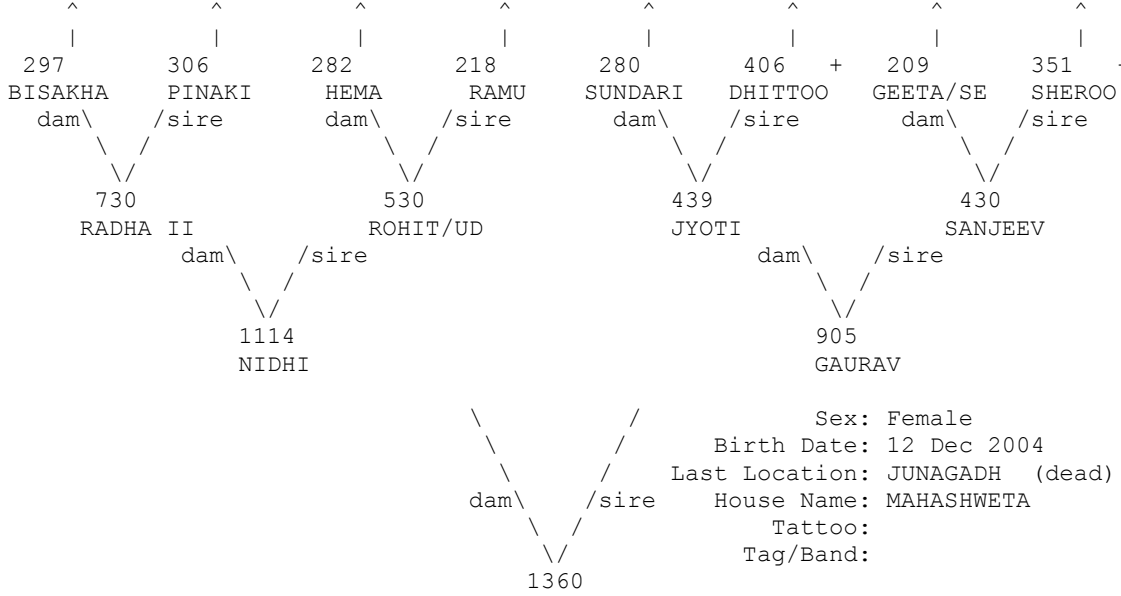

+ Wild-caught... * Appear more than once...
 ^ Pedigree continues beyond top of page...

=====
 Taxon Name: PANTHERA TIGRIS Studbook Number: 1361
 =====

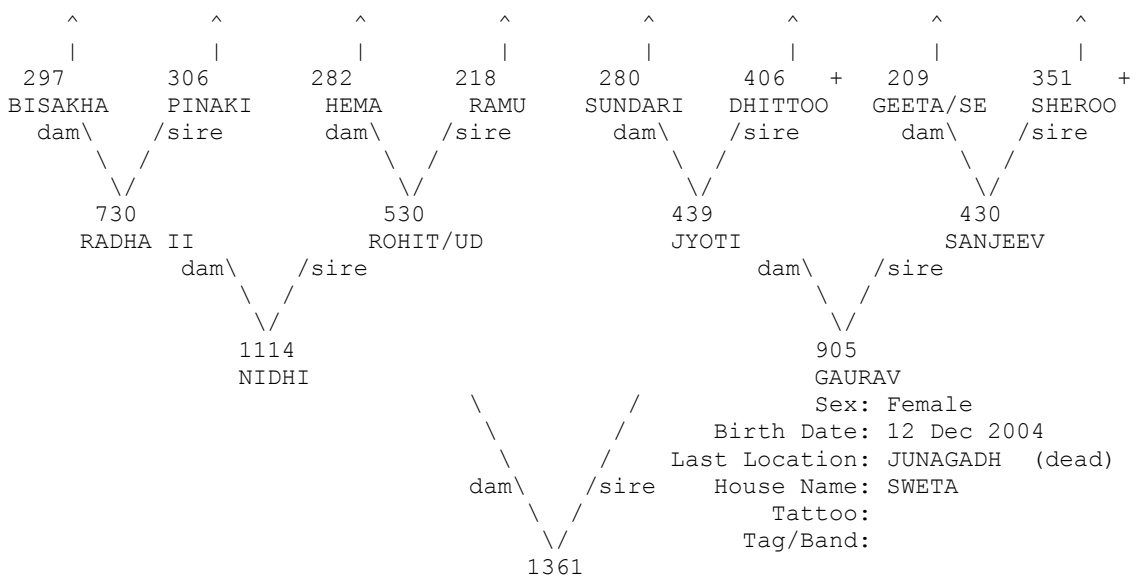

+ Wild-caught... * Appear more than once...
 ^ Pedigree continues beyond top of page...

=====
 Taxon Name: PANTHERA TIGRIS Studbook Number: 1362
 =====

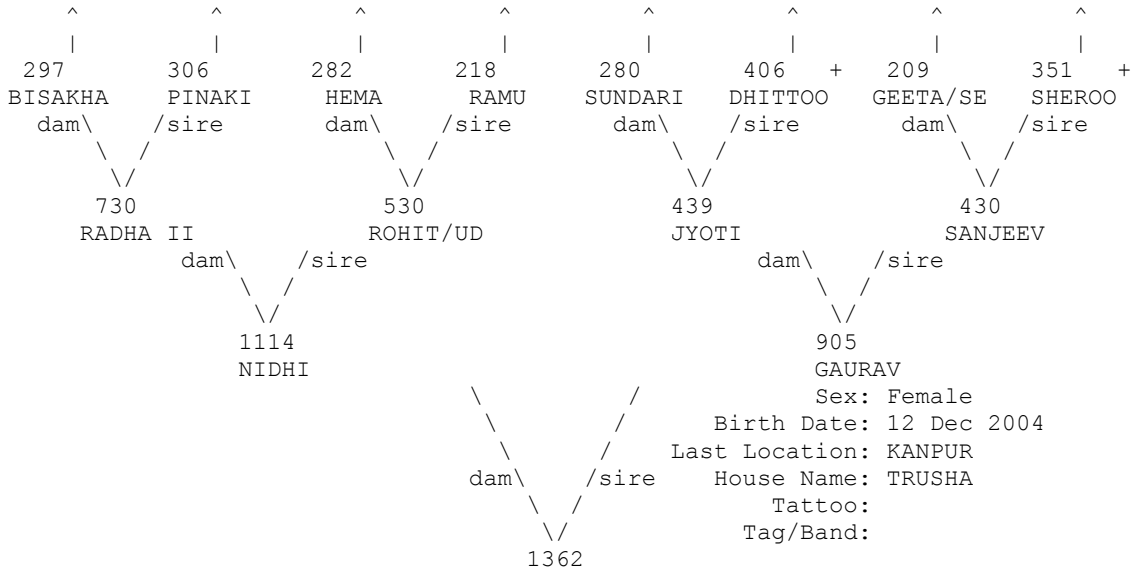

+ Wild-caught... * Appear more than once...
 ^ Pedigree continues beyond top of page...

=====

Taxon Name: PANTHERA TIGRIS Studbook Number: 1363

=====

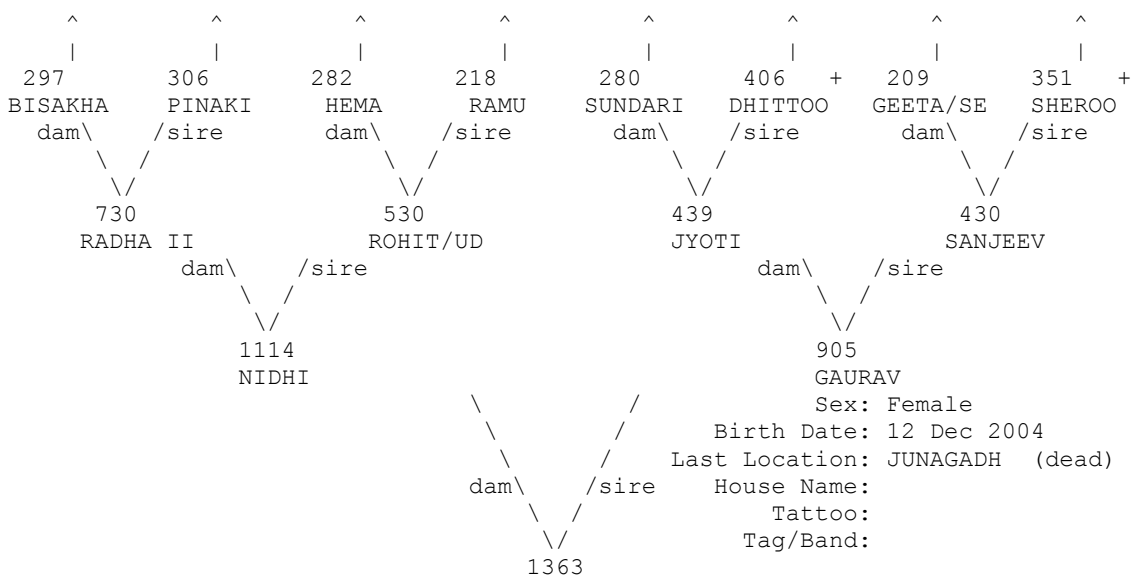

+ Wild-caught... * Appear more than once...

^ Pedigree continues beyond top of page...

=====

Taxon Name: PANTHERA TIGRIS Studbook Number: 1364

=====

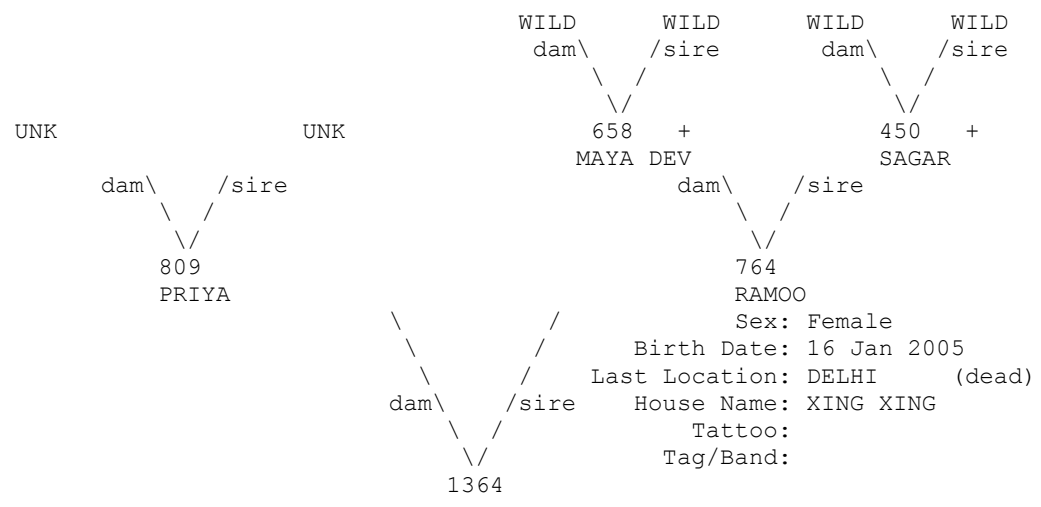

+ Wild-caught...

=====
Taxon Name: PANTHERA TIGRIS Studbook Number: 1365
=====

UNK dam\ /sire UNK
 \< /
 809
 PRIYA

 \< /
 dam\ /sire
 \< /
 1365
Sex: Male
Birth Date: 16 Jan 2005
Last Location: DELHI (dead)
House Name:
Tattoo:
Tag/Band:

=====
Taxon Name: PANTHERA TIGRIS Studbook Number: 1366
=====

UNK dam\ /sire UNK
 \< /
 809
 PRIYA

 \< /
 dam\ /sire
 \< /
 1366
Sex: Male
Birth Date: 16 Jan 2005
Last Location: DELHI (dead)
House Name:
Tattoo:
Tag/Band:

=====
Taxon Name: PANTHERA TIGRIS Studbook Number: 1367
=====

UNK dam\ /sire UNK
 \< /
 809
 PRIYA

 \< /
 dam\ /sire
 \< /
 1367
Sex: Male
Birth Date: 16 Jan 2005
Last Location: DELHI (dead)
House Name:
Tattoo:
Tag/Band:

=====
Taxon Name: PANTHERA TIGRIS Studbook Number: 1368
=====

UNK dam\ /sire UNK
 \< /
 809
 PRIYA

 \< /
 dam\ /sire
 \< /
 1368
Sex: Male
Birth Date: 16 Jan 2005
Last Location: DELHI (dead)
House Name:
Tattoo:
Tag/Band:

=====
 Taxon Name: PANTHERA TIGRIS Studbook Number: 1369
 =====

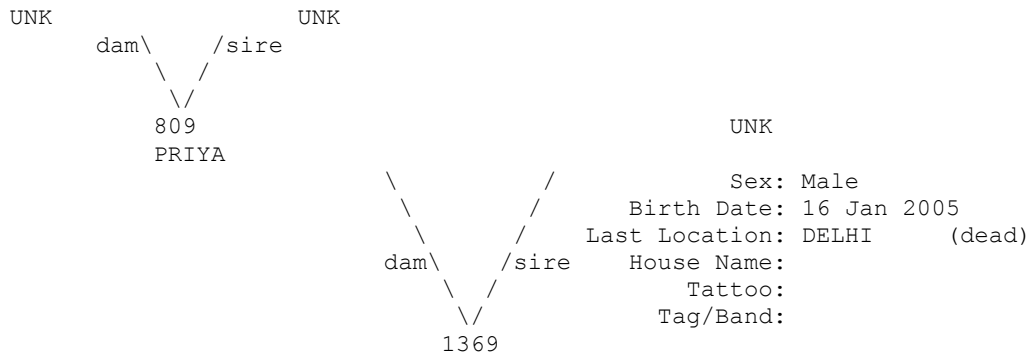

=====
 Taxon Name: PANTHERA TIGRIS Studbook Number: 1370
 =====

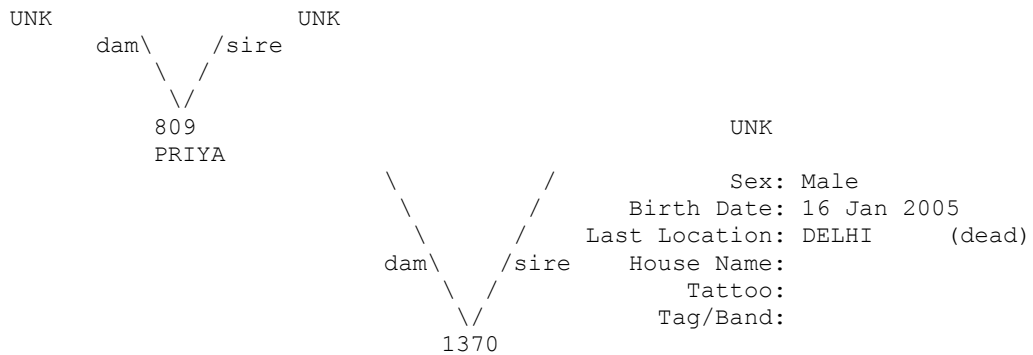

=====
 Taxon Name: PANTHERA TIGRIS Studbook Number: 1371
 =====

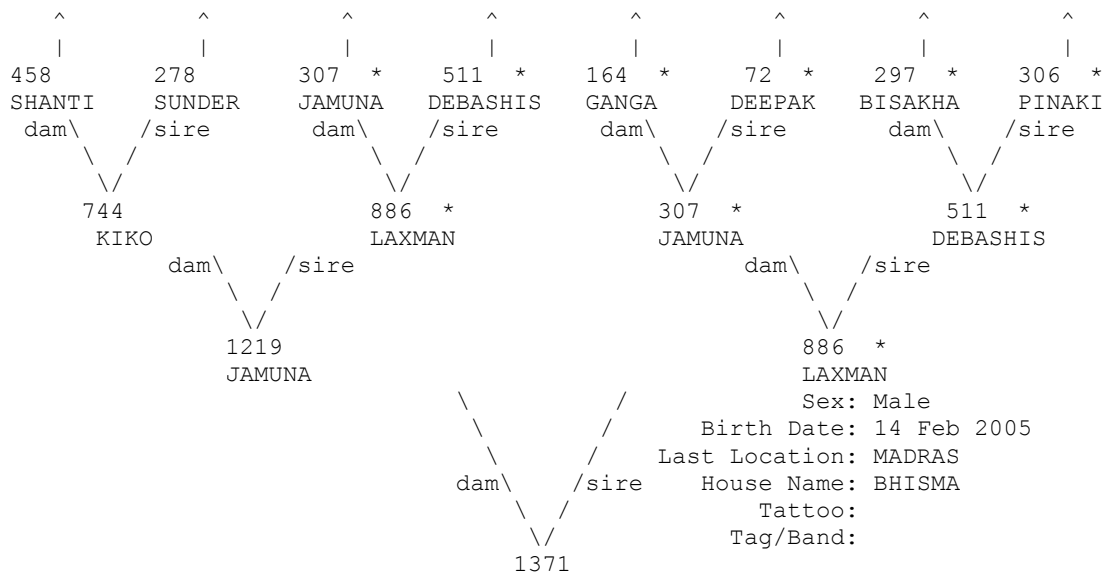

* Appear more than once...
 ^ Pedigree continues beyond top of page...

=====
 Taxon Name: PANTHERA TIGRIS Studbook Number: 1372
 =====

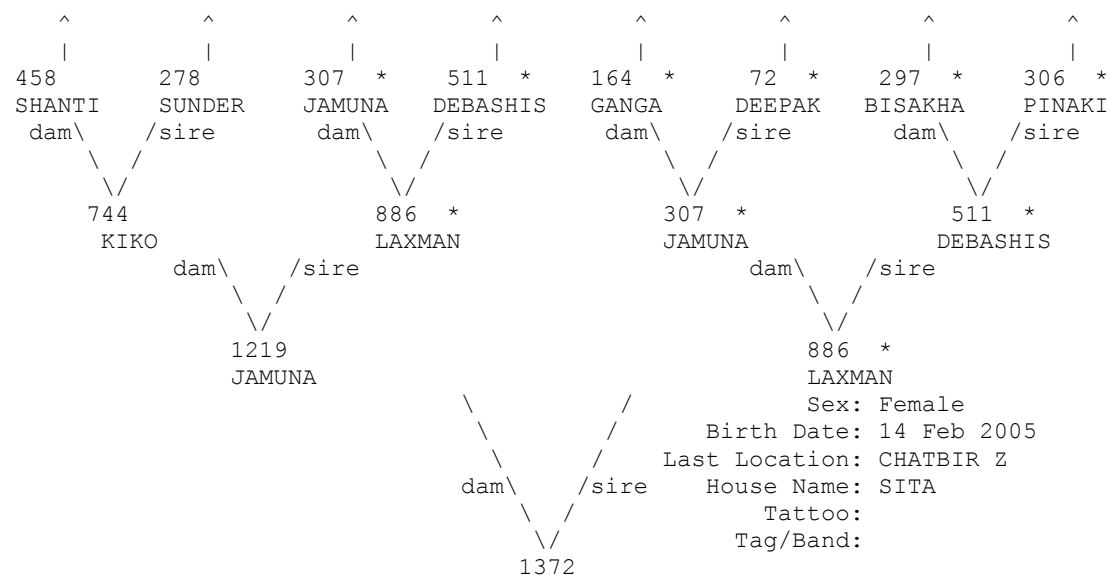

* Appear more than once...
 ^ Pedigree continues beyond top of page...

=====
 Taxon Name: PANTHERA TIGRIS Studbook Number: 1374
 =====

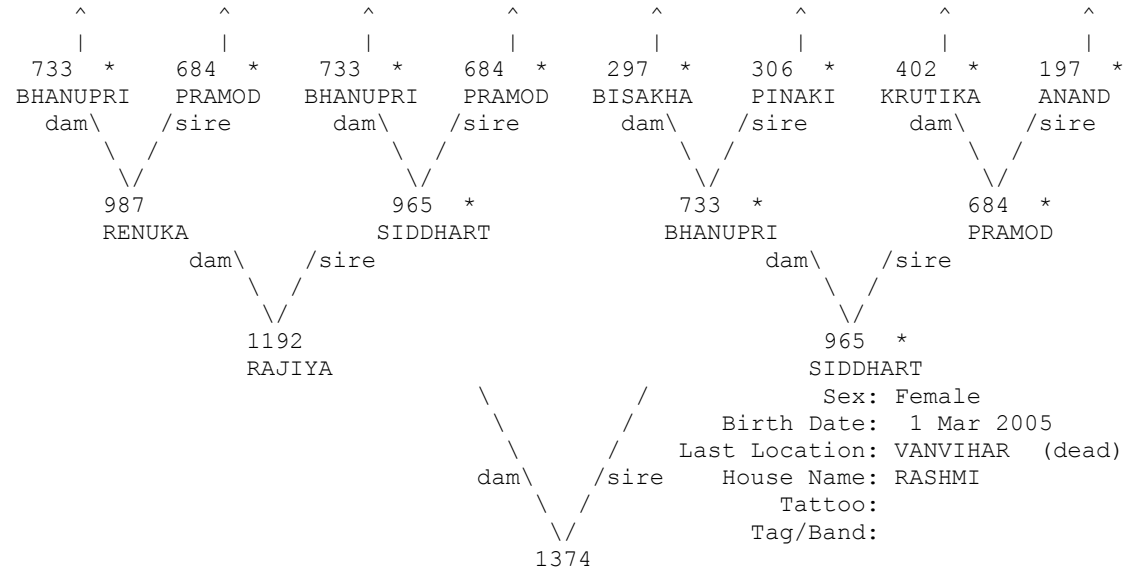

* Appear more than once...
 ^ Pedigree continues beyond top of page...

=====
 Taxon Name: PANTHERA TIGRIS Studbook Number: 1375
 =====

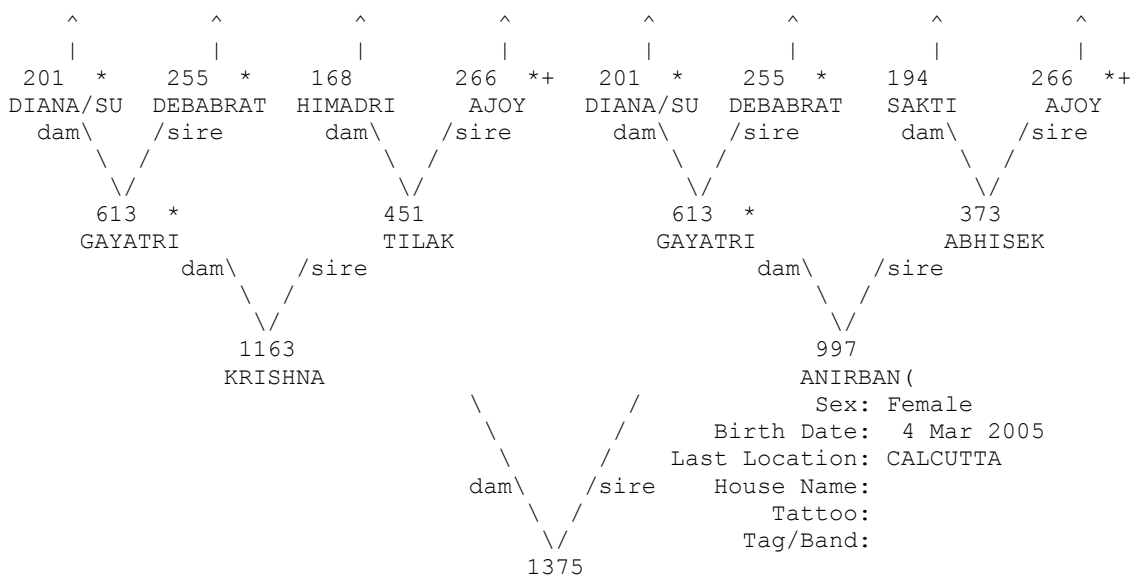

+ Wild-caught... * Appear more than once...
 ^ Pedigree continues beyond top of page...

=====
 Taxon Name: PANTHERA TIGRIS Studbook Number: 1376
 =====

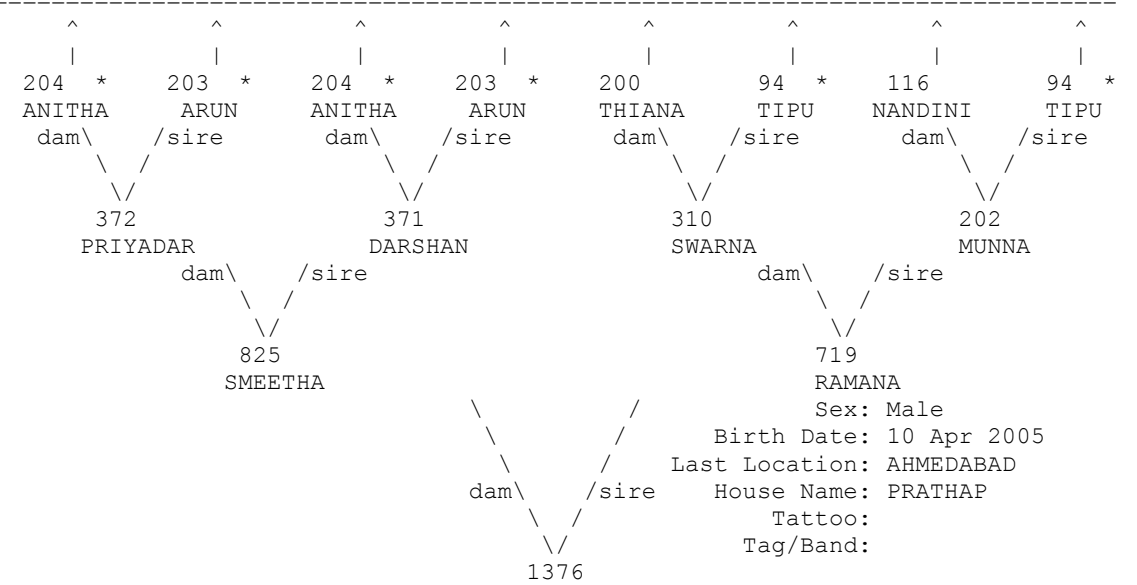

* Appear more than once...
 ^ Pedigree continues beyond top of page...

=====
 Taxon Name: PANTHERA TIGRIS Studbook Number: 1377
 =====

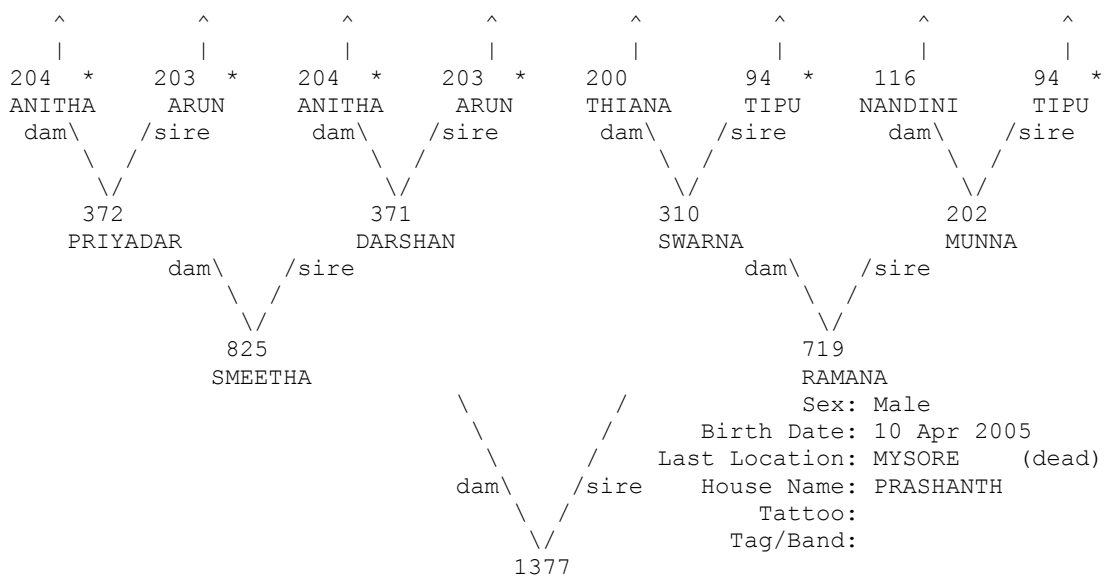

* Appear more than once...
 ^ Pedigree continues beyond top of page...

=====
 Taxon Name: PANTHERA TIGRIS Studbook Number: 1378
 =====

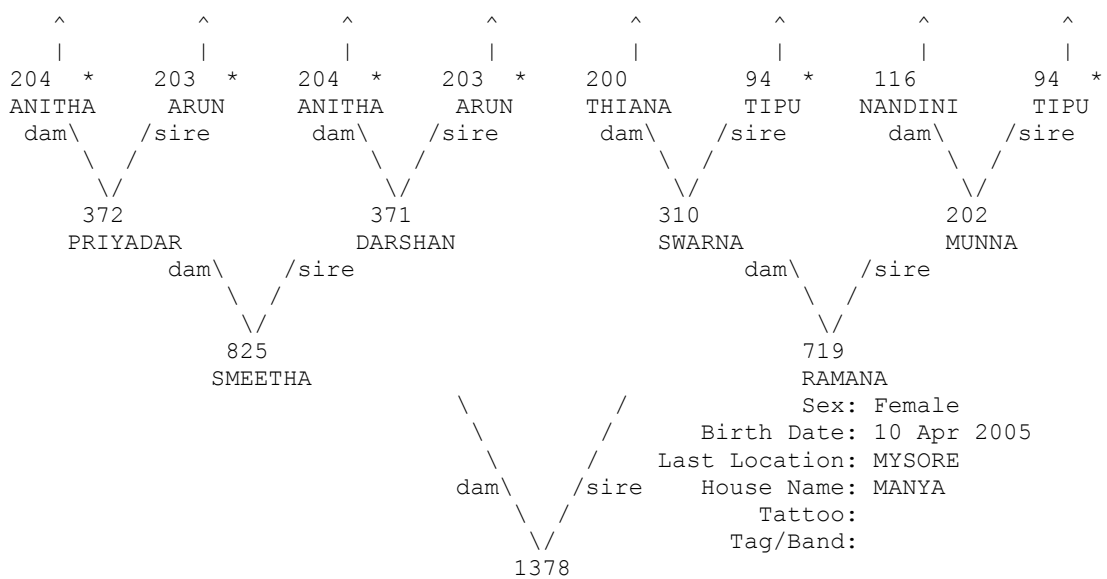

* Appear more than once...
 ^ Pedigree continues beyond top of page...

=====
 Taxon Name: PANTHERA TIGRIS Studbook Number: 1379
 =====

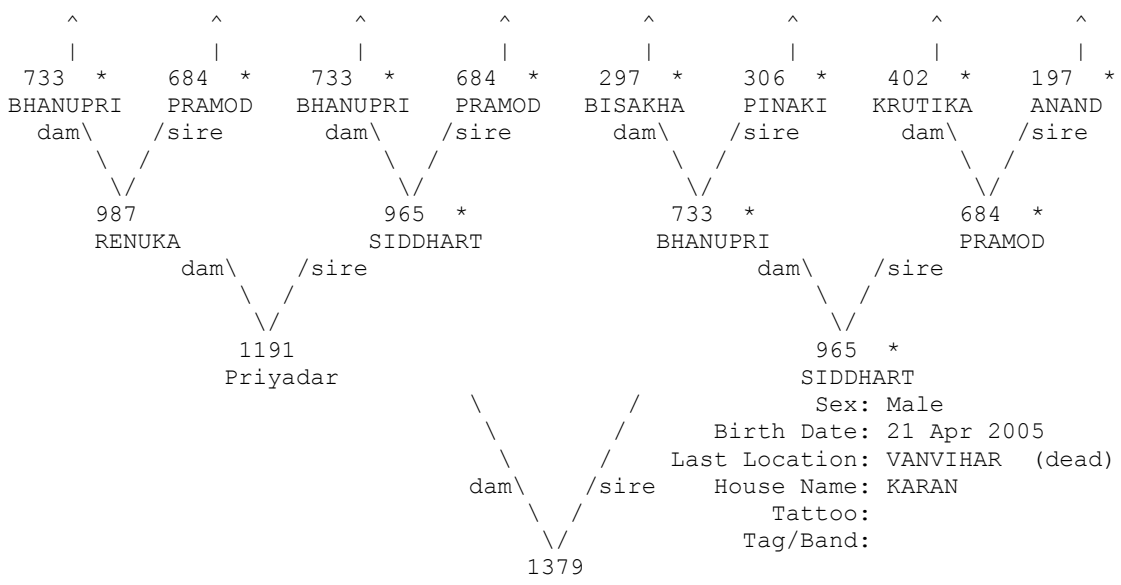

* Appear more than once...
 ^ Pedigree continues beyond top of page...

=====
 Taxon Name: PANTHERA TIGRIS Studbook Number: 1380
 =====

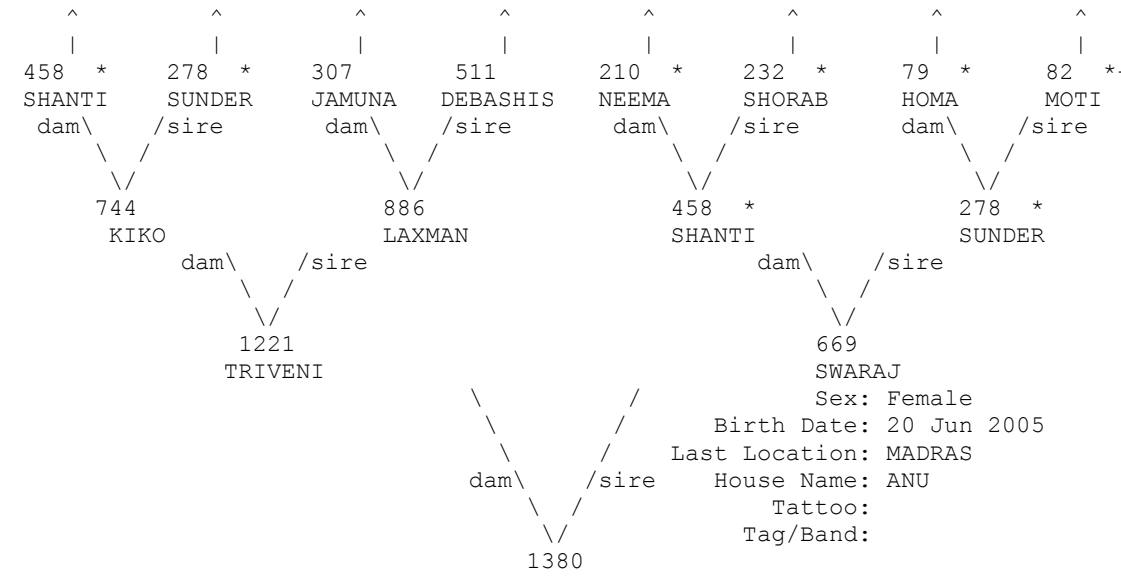

+ Wild-caught... * Appear more than once...
 ^ Pedigree continues beyond top of page...

=====
 Taxon Name: PANTHERA TIGRIS Studbook Number: 1381
 =====

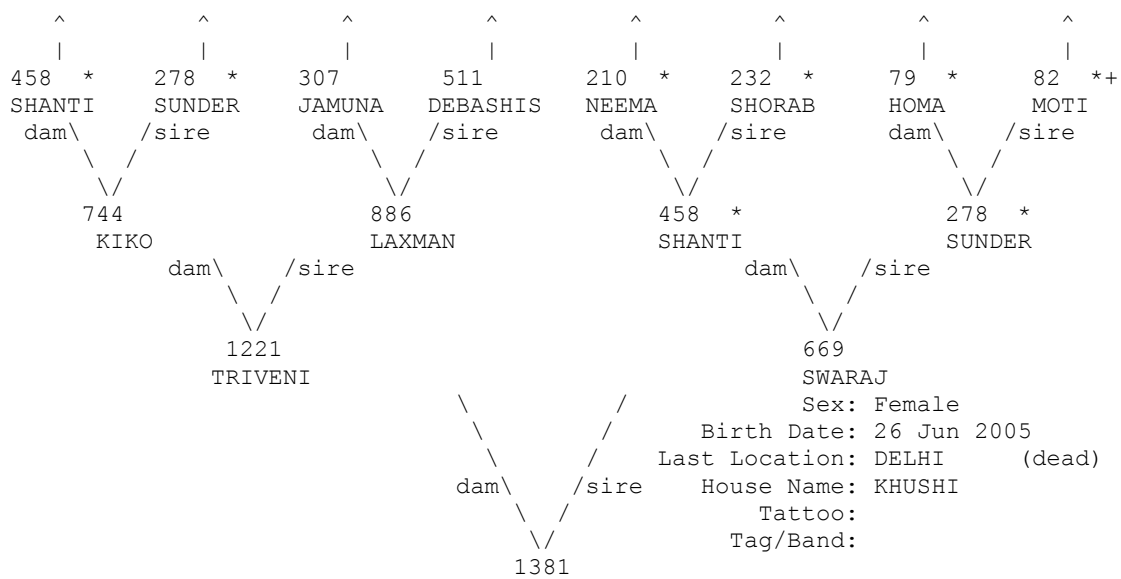

+ Wild-caught... * Appear more than once...
 ^ Pedigree continues beyond top of page...

=====
 Taxon Name: PANTHERA TIGRIS Studbook Number: 1382
 =====

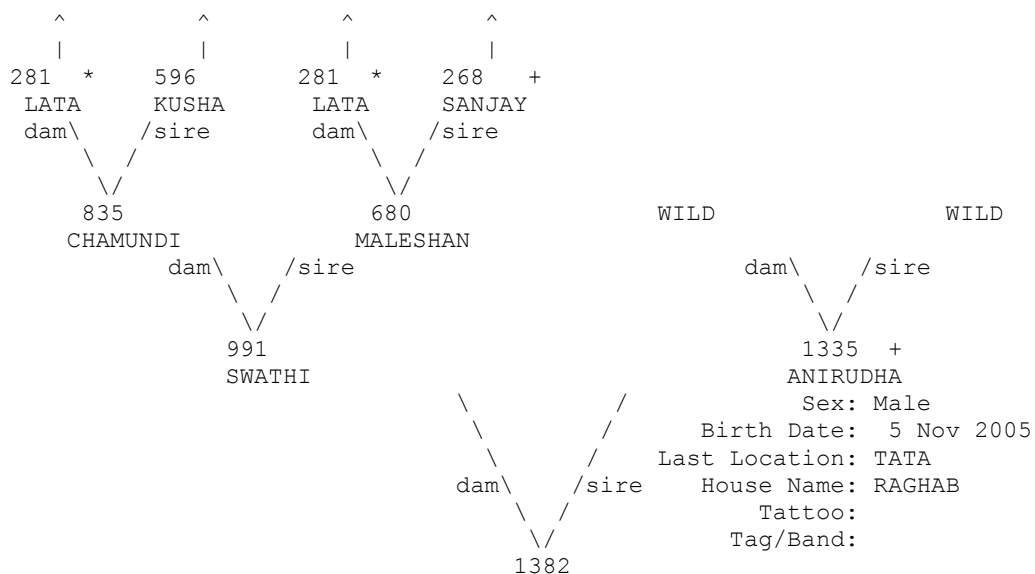

+ Wild-caught... * Appear more than once...
 ^ Pedigree continues beyond top of page...

=====
 Taxon Name: PANTHERA TIGRIS Studbook Number: 1383
 =====

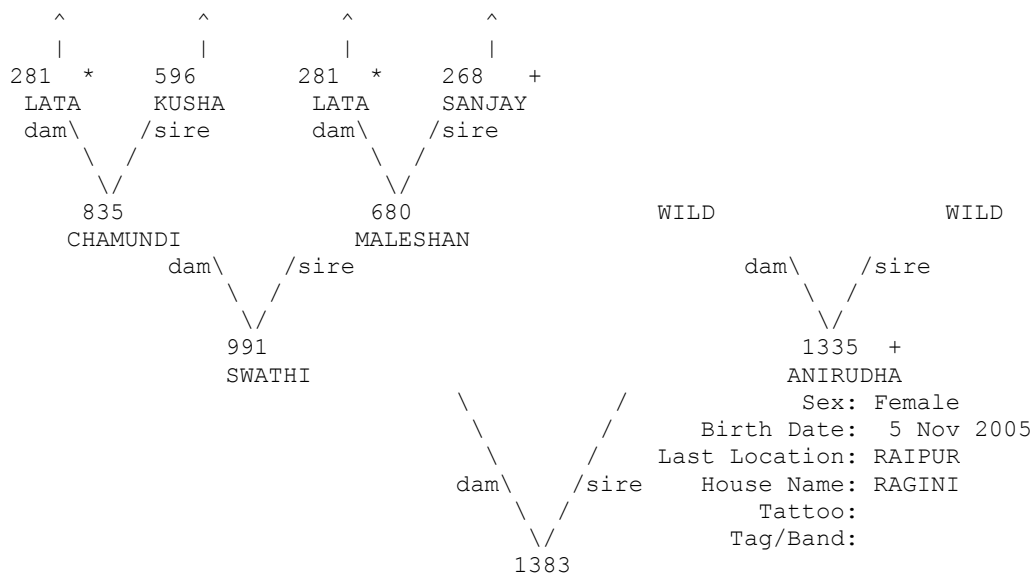

+ Wild-caught... * Appear more than once...
 ^ Pedigree continues beyond top of page...

=====
 Taxon Name: PANTHERA TIGRIS Studbook Number: 1384
 =====

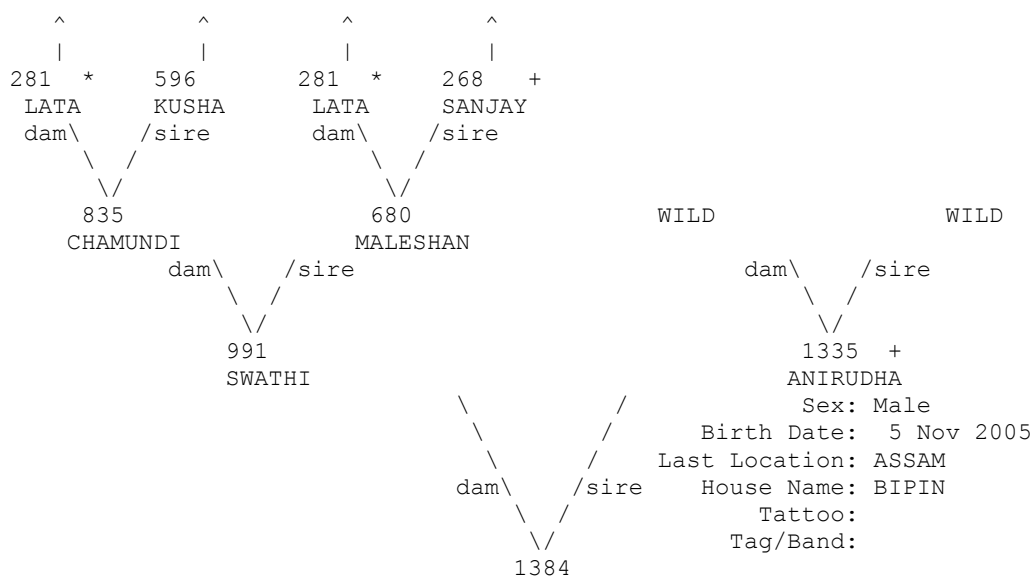

+ Wild-caught... * Appear more than once...
 ^ Pedigree continues beyond top of page...

=====
 Taxon Name: PANTHERA TIGRIS Studbook Number: 1385
 =====

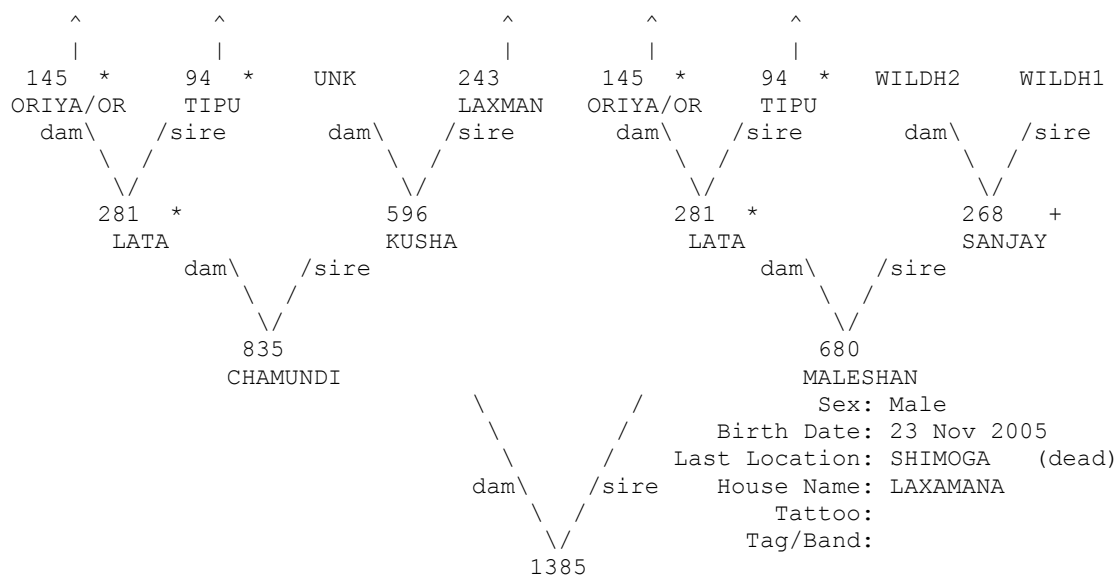

+ Wild-caught... * Appear more than once...
 ^ Pedigree continues beyond top of page...

=====
 Taxon Name: PANTHERA TIGRIS Studbook Number: 1386
 =====

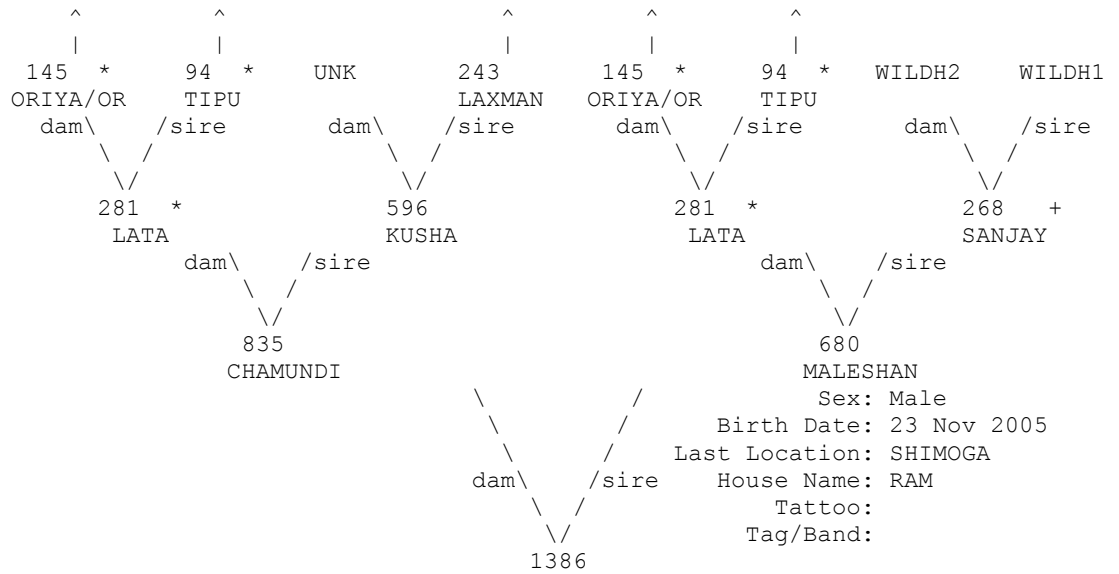

+ Wild-caught... * Appear more than once...
 ^ Pedigree continues beyond top of page...

=====
 Taxon Name: PANTHERA TIGRIS Studbook Number: 1387
 =====

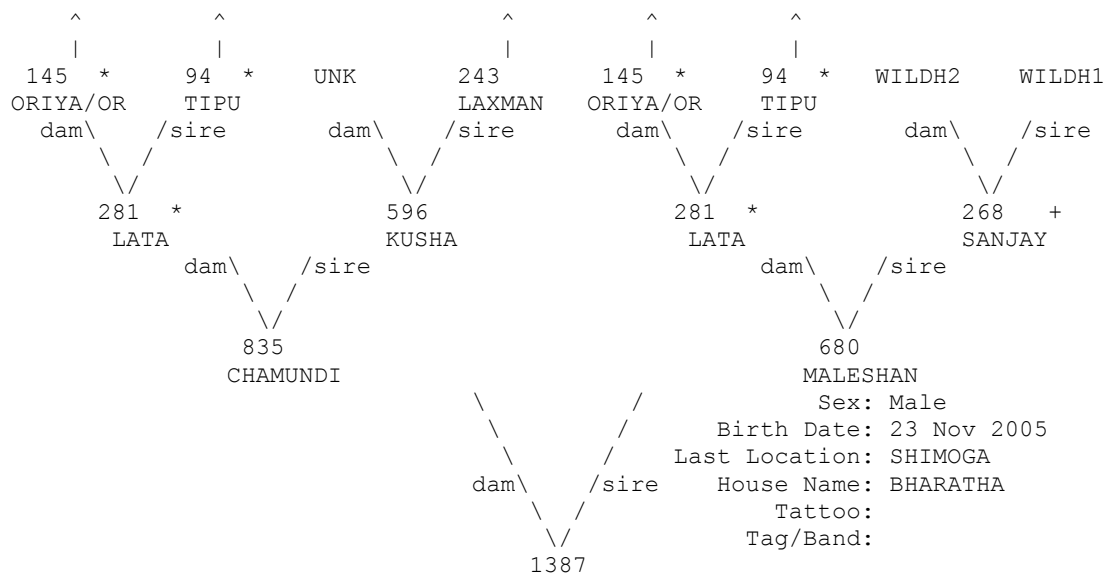

+ Wild-caught... * Appear more than once...
 ^ Pedigree continues beyond top of page...

=====
 Taxon Name: PANTHERA TIGRIS Studbook Number: 1388
 =====

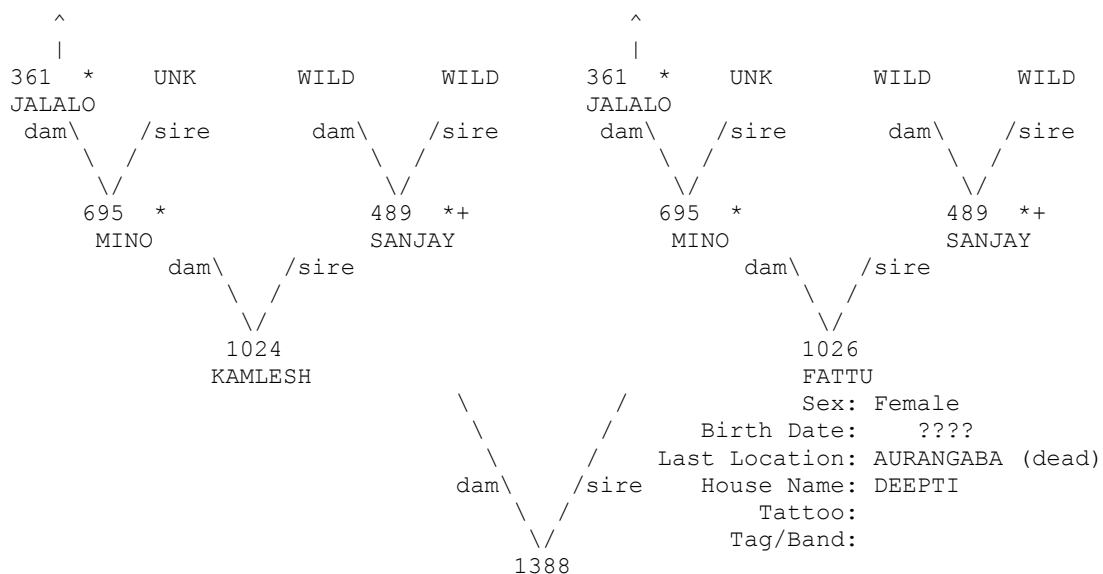

+ Wild-caught... * Appear more than once...
 ^ Pedigree continues beyond top of page...

=====
 Taxon Name: PANTHERA TIGRIS Studbook Number: 1389
 =====

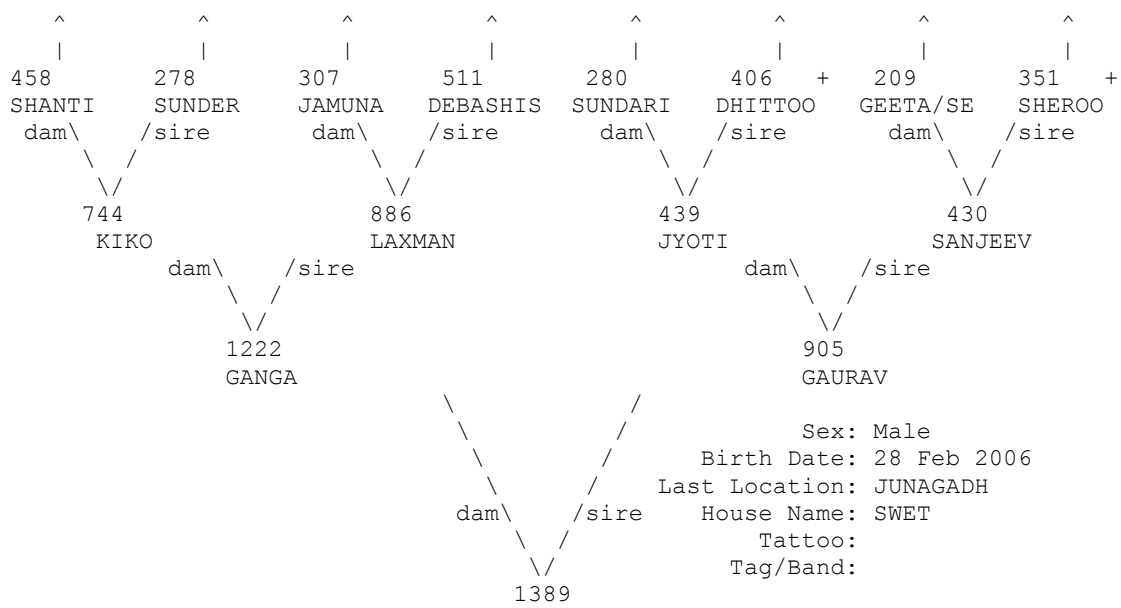

+ Wild-caught... * Appear more than once...
 ^ Pedigree continues beyond top of page...

=====
 Taxon Name: PANTHERA TIGRIS Studbook Number: 1390
 =====

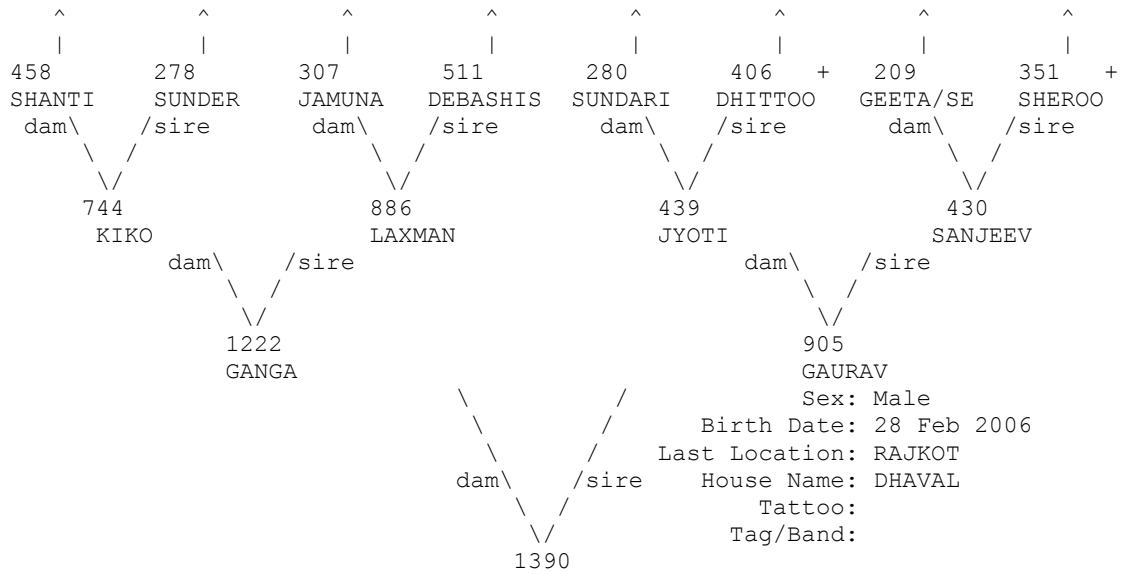

+ Wild-caught... * Appear more than once...
 ^ Pedigree continues beyond top of page...

=====
 Taxon Name: PANTHERA TIGRIS Studbook Number: 1391
 =====

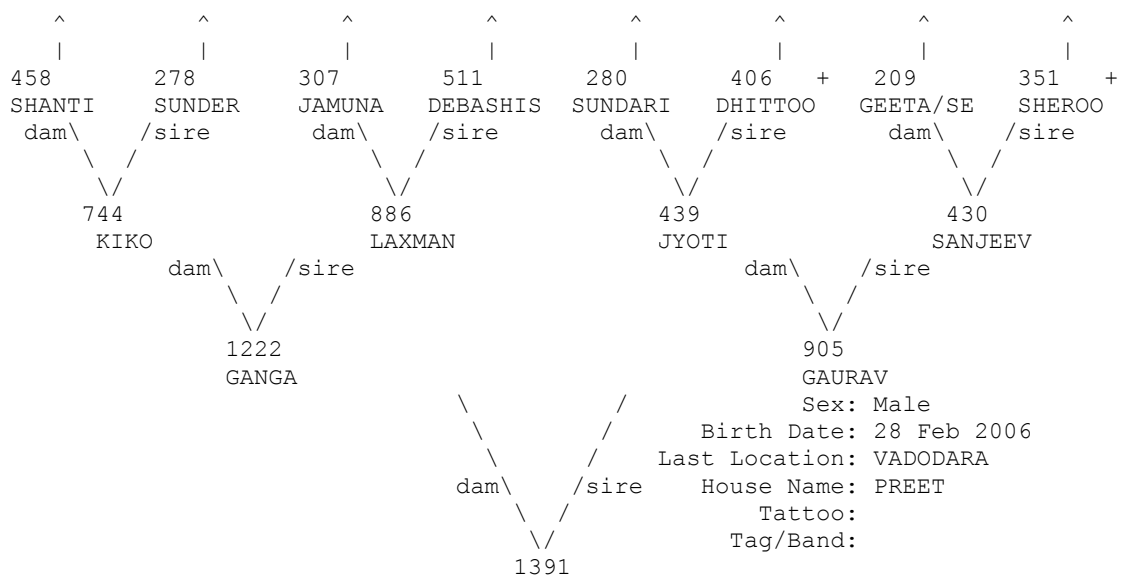

+ Wild-caught... * Appear more than once...
 ^ Pedigree continues beyond top of page...

=====
 Taxon Name: PANTHERA TIGRIS Studbook Number: 1392
 =====

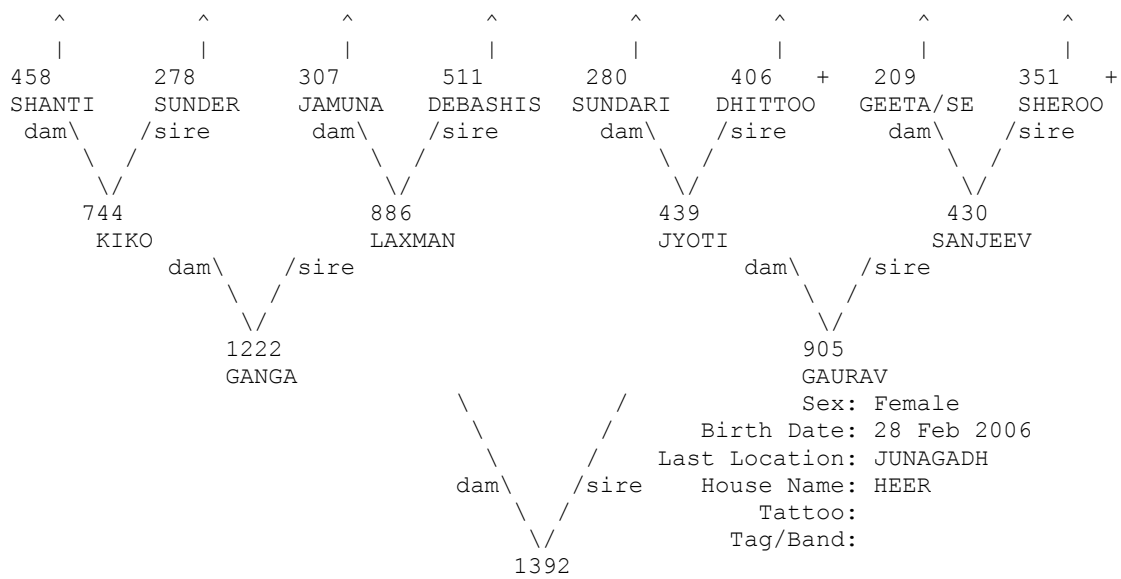

+ Wild-caught... * Appear more than once...
 ^ Pedigree continues beyond top of page...

=====
 Taxon Name: PANTHERA TIGRIS Studbook Number: 1395
 =====

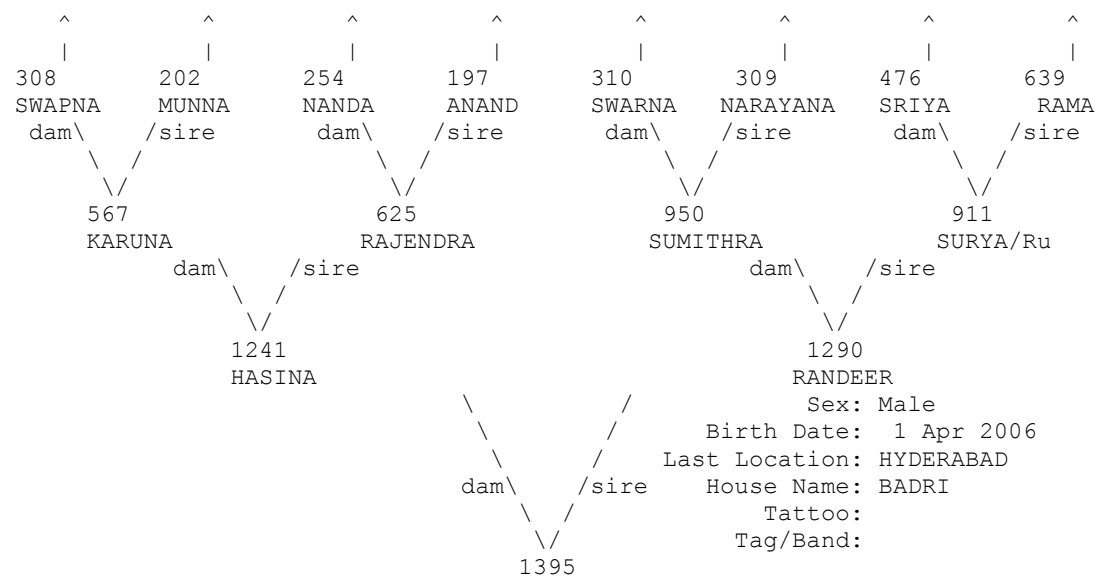

* Appear more than once...
 ^ Pedigree continues beyond top of page...

=====
 Taxon Name: PANTHERA TIGRIS Studbook Number: 1396
 =====

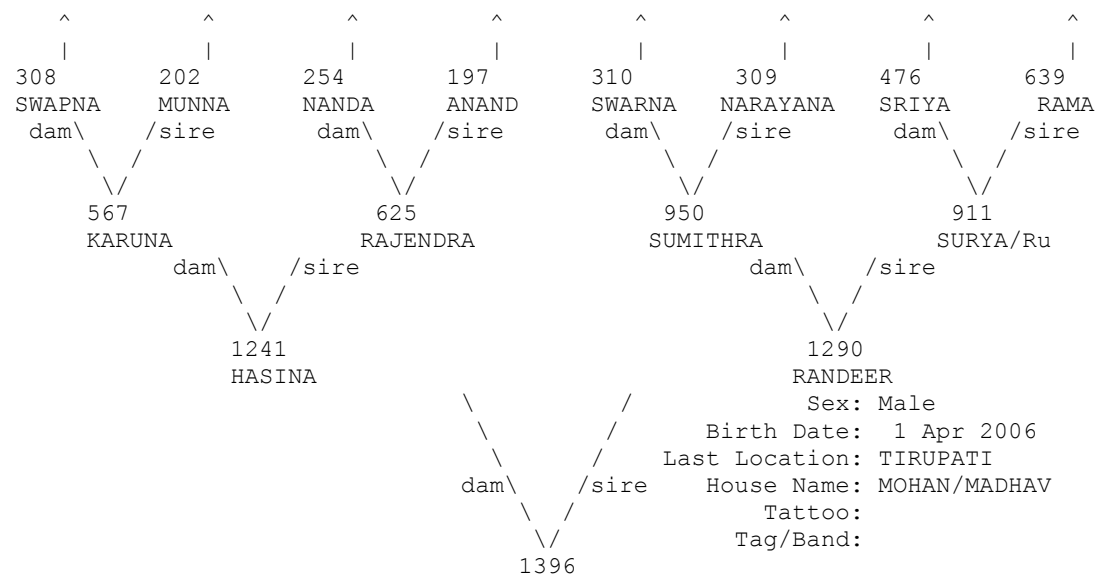

* Appear more than once...
 ^ Pedigree continues beyond top of page...

=====
 Taxon Name: PANTHERA TIGRIS Studbook Number: 1397
 =====

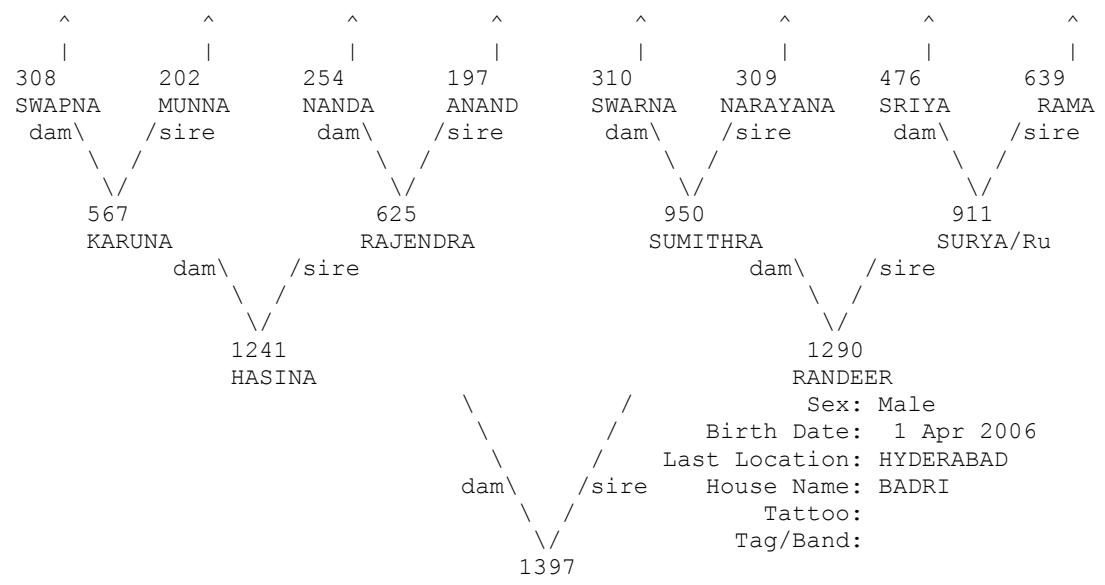

* Appear more than once...
 ^ Pedigree continues beyond top of page...

=====
 Taxon Name: PANTHERA TIGRIS Studbook Number: 1398
 =====

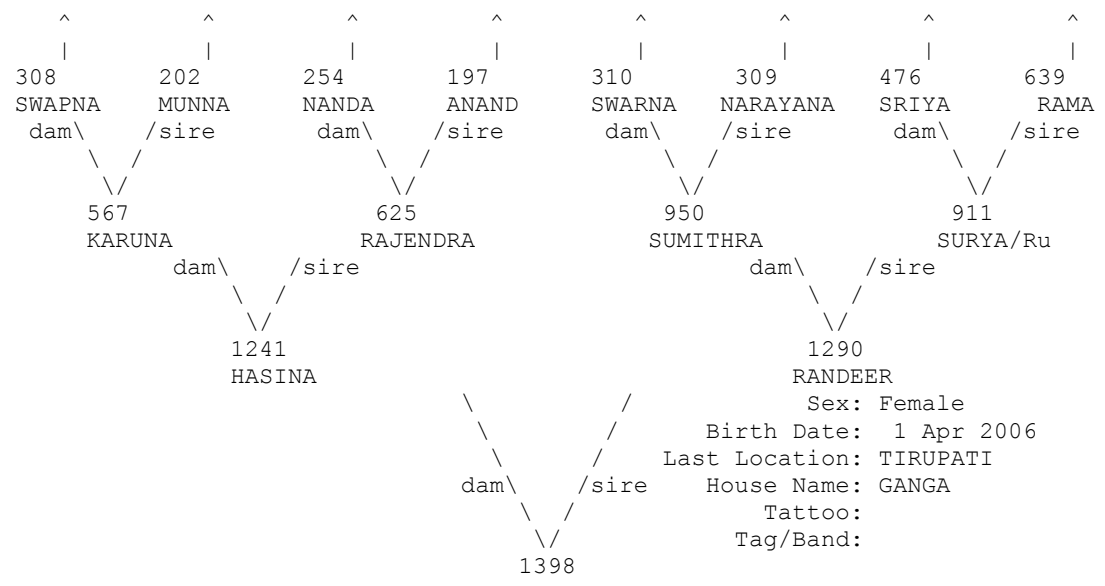

* Appear more than once...
 ^ Pedigree continues beyond top of page...

=====
 Taxon Name: PANTHERA TIGRIS Studbook Number: 1399
 =====

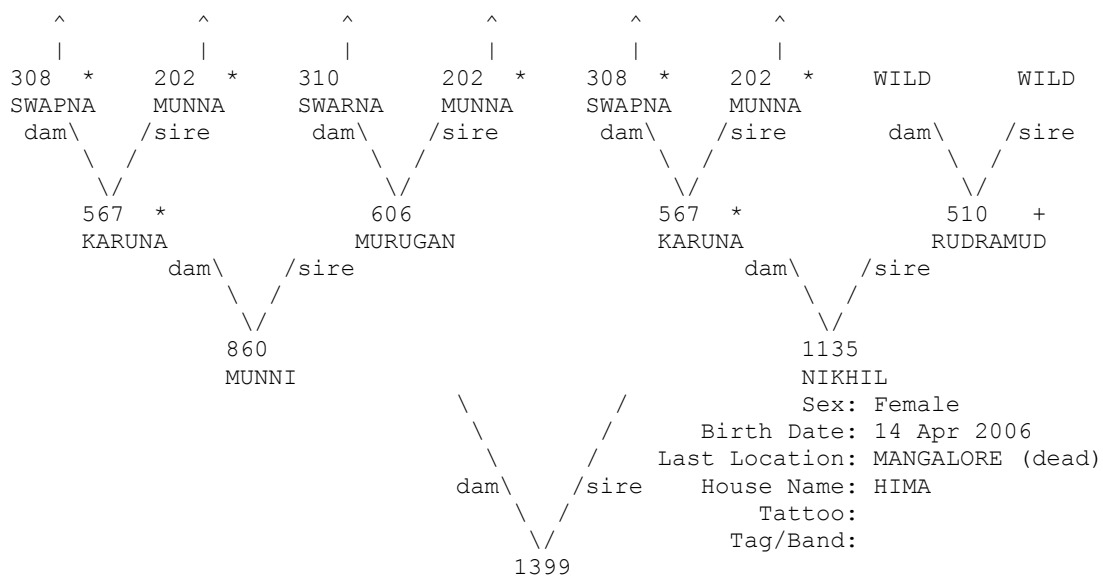

+ Wild-caught... * Appear more than once...
 ^ Pedigree continues beyond top of page...

=====
 Taxon Name: PANTHERA TIGRIS Studbook Number: 1400
 =====

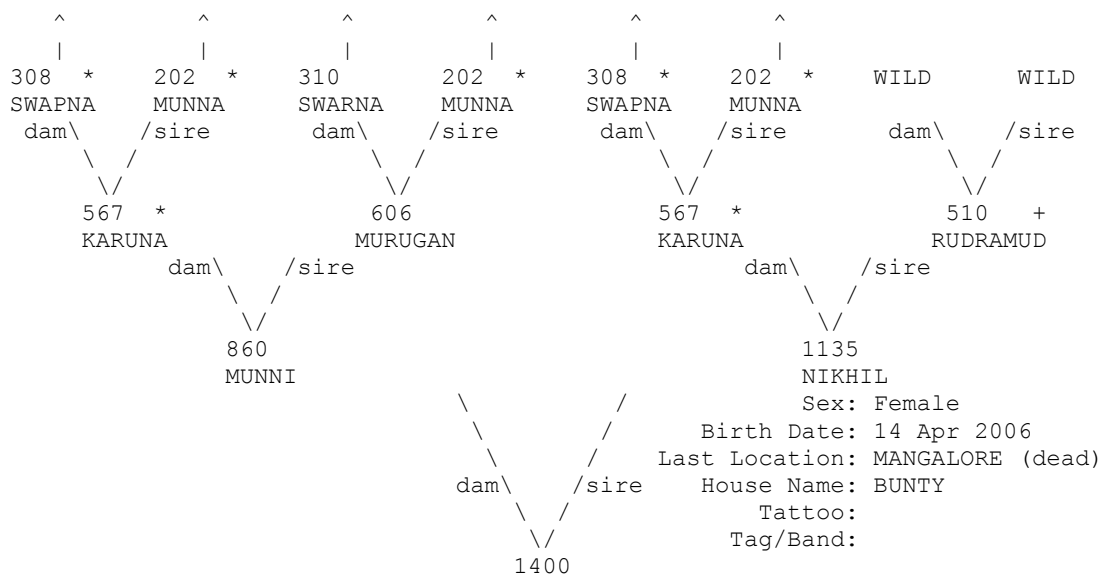

+ Wild-caught... * Appear more than once...
 ^ Pedigree continues beyond top of page...

=====
 Taxon Name: PANTHERA TIGRIS Studbook Number: 1408
 =====

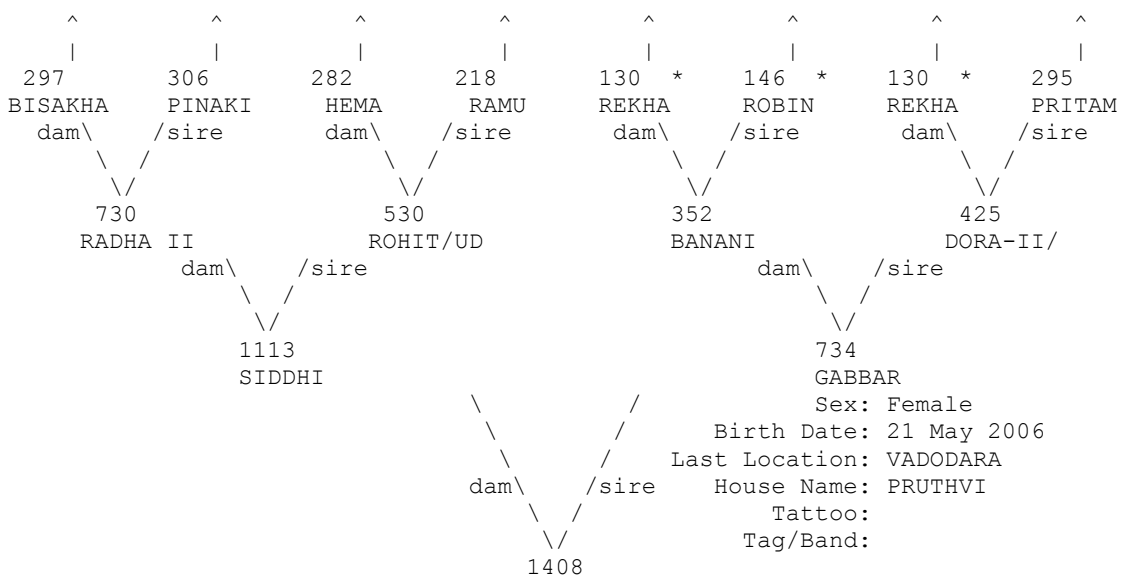

* Appear more than once...
 ^ Pedigree continues beyond top of page...

=====
 Taxon Name: PANTHERA TIGRIS Studbook Number: 1409
 =====

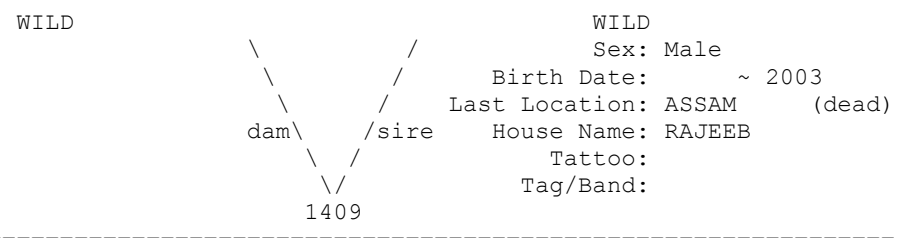

=====
 Taxon Name: PANTHERA TIGRIS Studbook Number: 1410
 =====

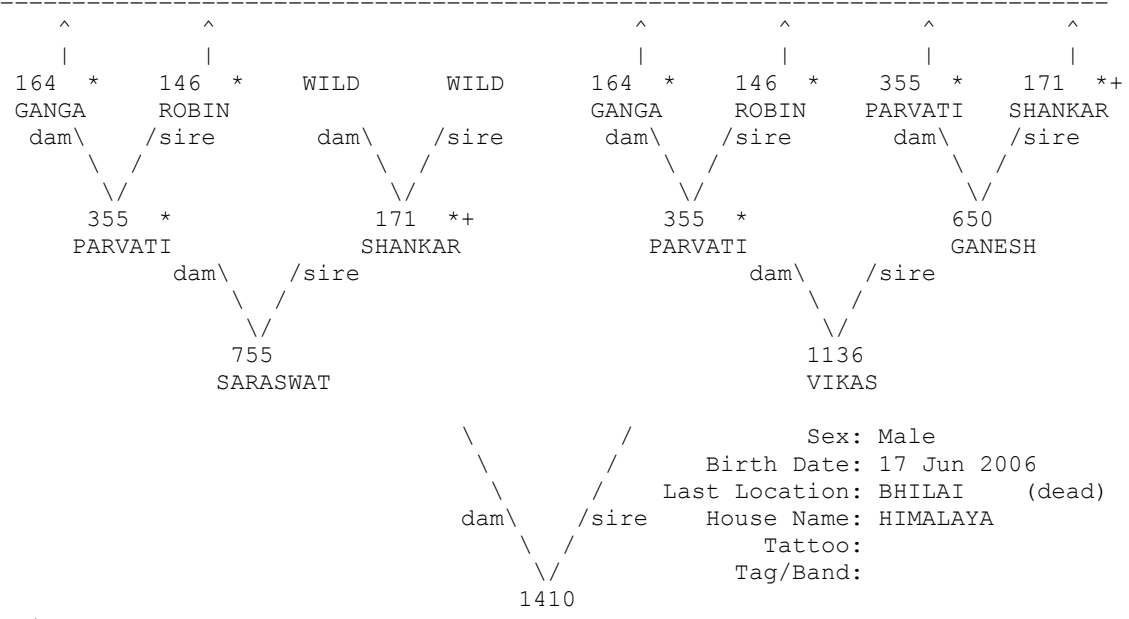

+ Wild-caught... * Appear more than once...
 ^ Pedigree continues beyond top of page...

=====
 Taxon Name: PANTHERA TIGRIS Studbook Number: 1411
 =====

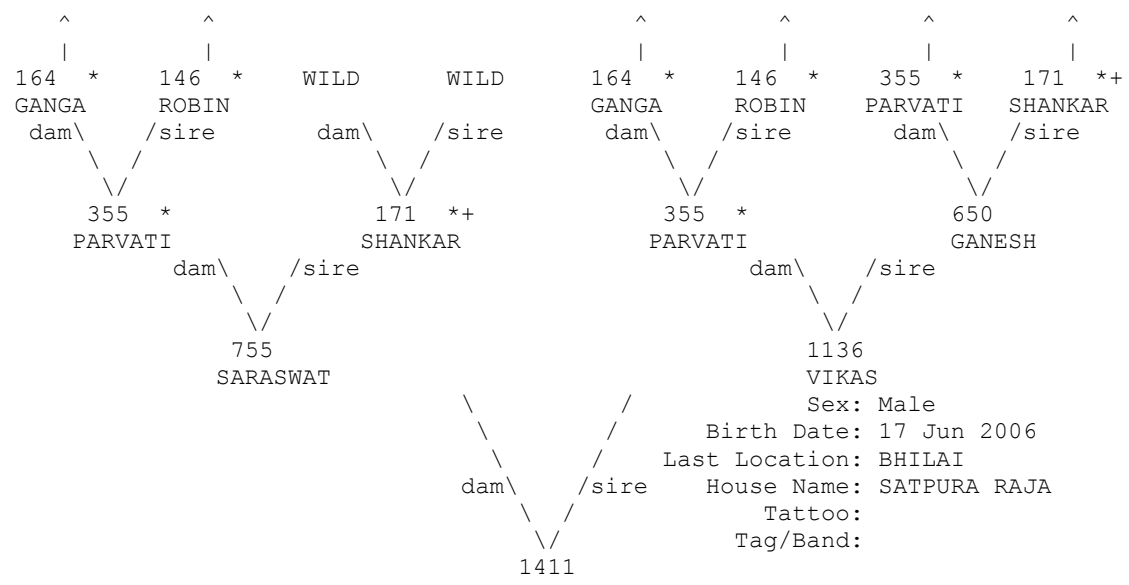

+ Wild-caught... * Appear more than once...
 ^ Pedigree continues beyond top of page...

=====
 Taxon Name: PANTHERA TIGRIS Studbook Number: 1412
 =====

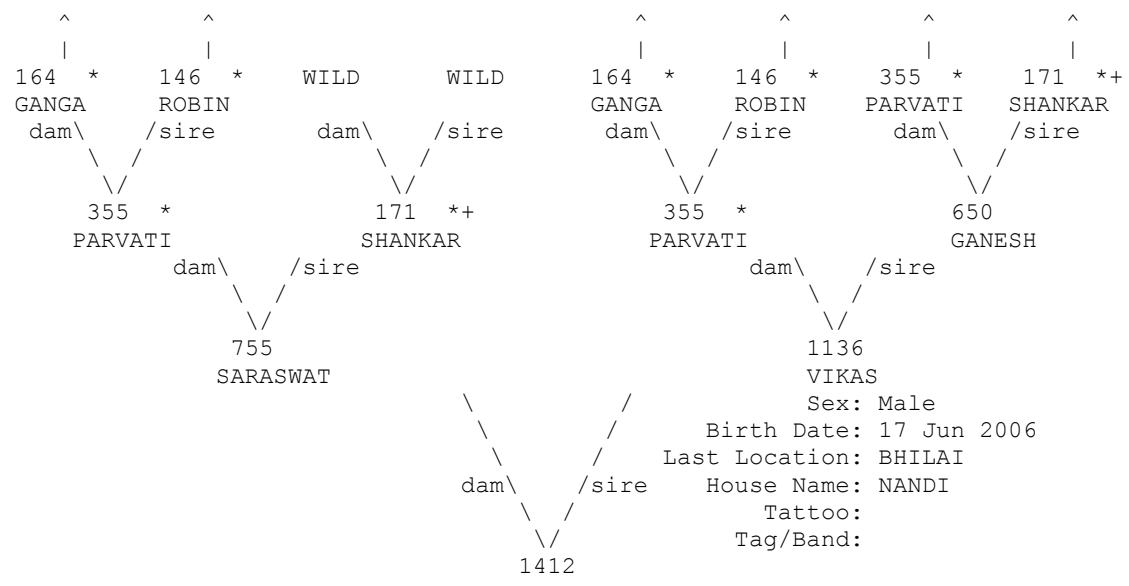

+ Wild-caught... * Appear more than once...
 ^ Pedigree continues beyond top of page...

=====
 Taxon Name: PANTHERA TIGRIS Studbook Number: 1413
 =====

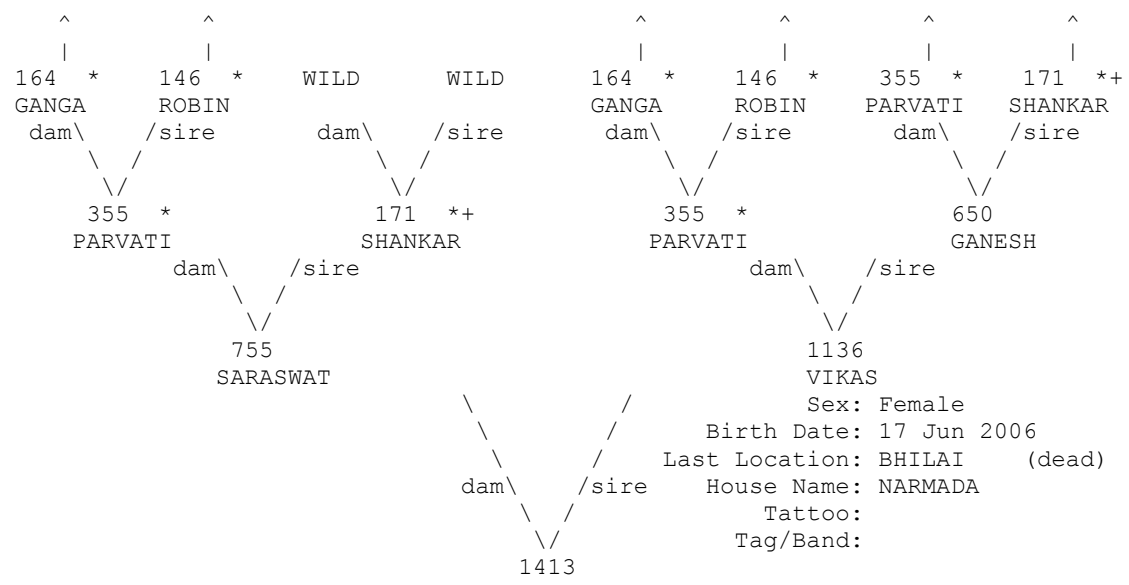

+ Wild-caught... * Appear more than once...
 ^ Pedigree continues beyond top of page...

=====
 Taxon Name: PANTHERA TIGRIS Studbook Number: 1414
 =====

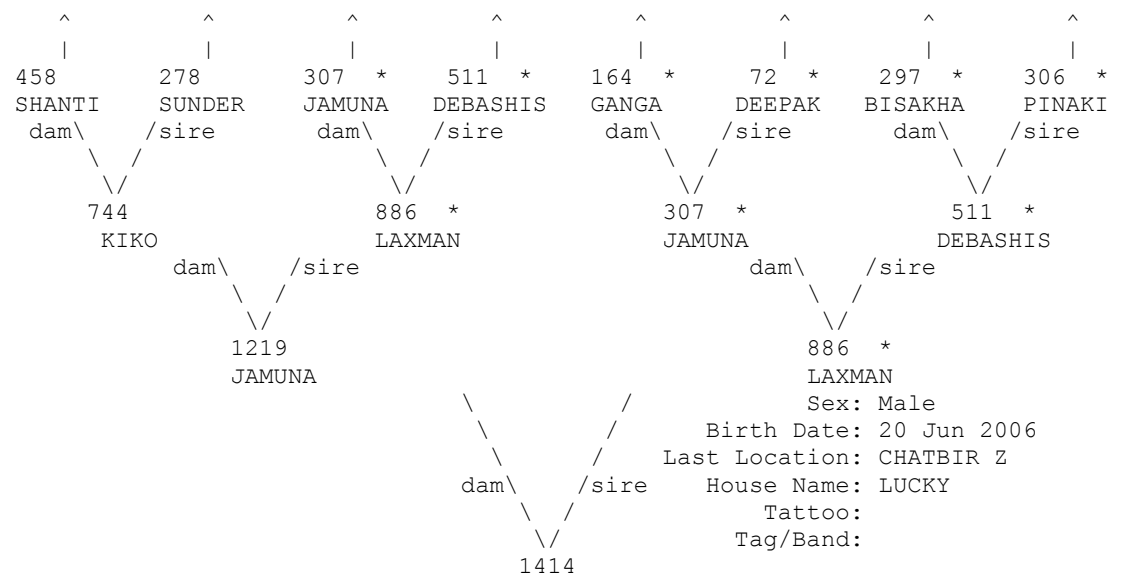

* Appear more than once...
 ^ Pedigree continues beyond top of page...

=====
 Taxon Name: PANTHERA TIGRIS Studbook Number: 1415
 =====

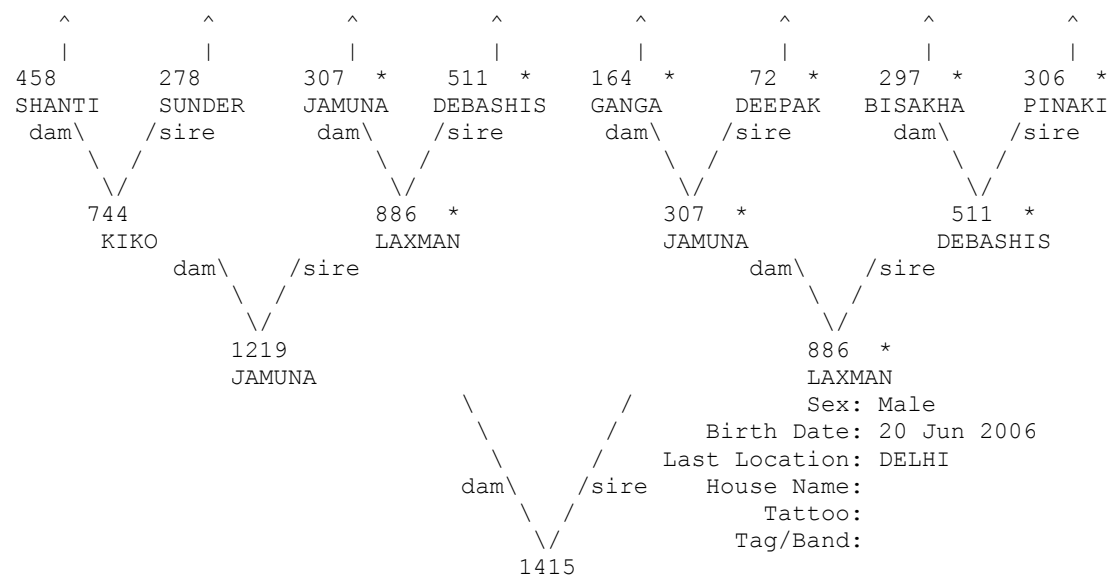

* Appear more than once...
 ^ Pedigree continues beyond top of page...

=====
 Taxon Name: PANTHERA TIGRIS Studbook Number: 1416
 =====

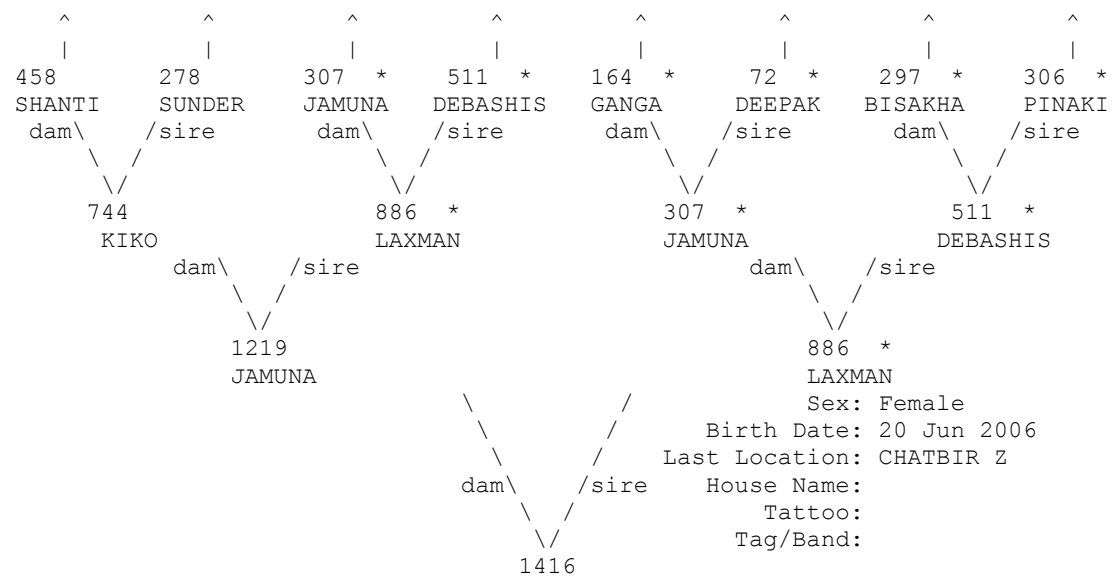

* Appear more than once...
 ^ Pedigree continues beyond top of page...

=====
 Taxon Name: PANTHERA TIGRIS Studbook Number: 1417
 =====

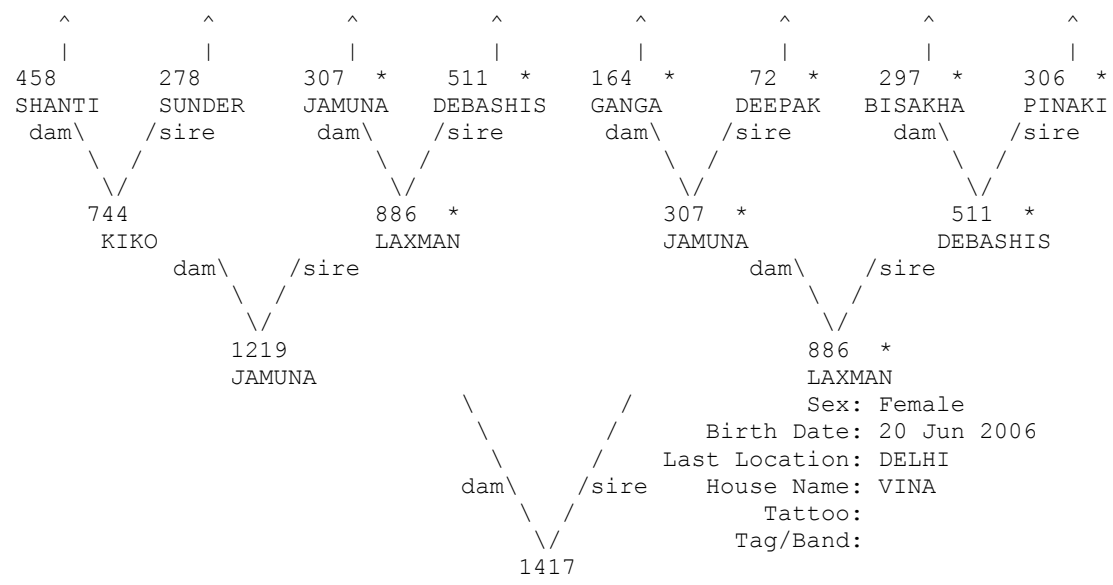

* Appear more than once...
 ^ Pedigree continues beyond top of page...

=====
 Taxon Name: PANTHERA TIGRIS Studbook Number: 1418
 =====

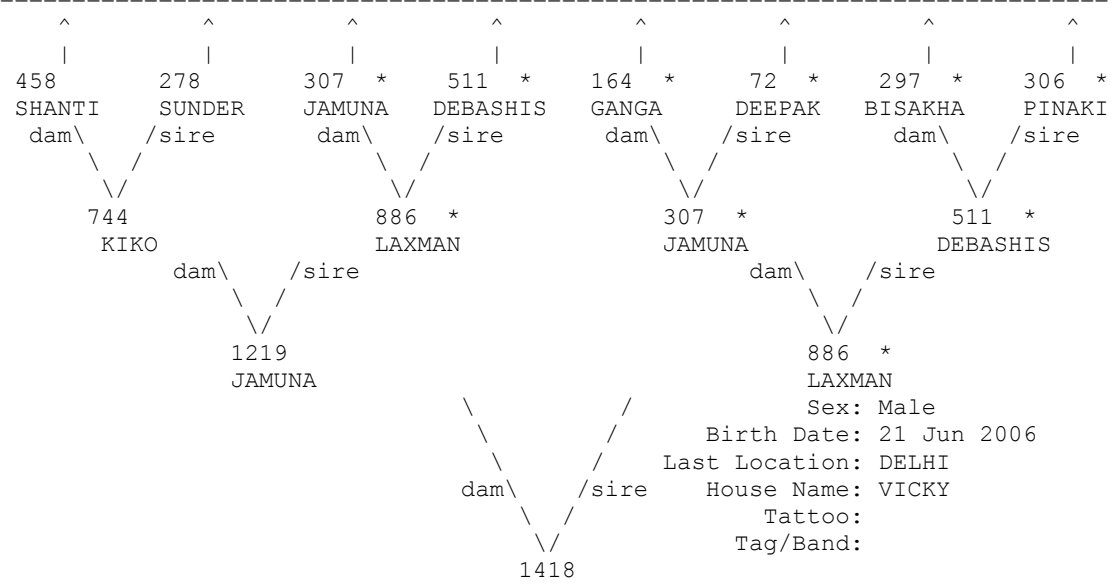

* Appear more than once...
 ^ Pedigree continues beyond top of page...

=====
 Taxon Name: PANTHERA TIGRIS Studbook Number: 1419
 =====

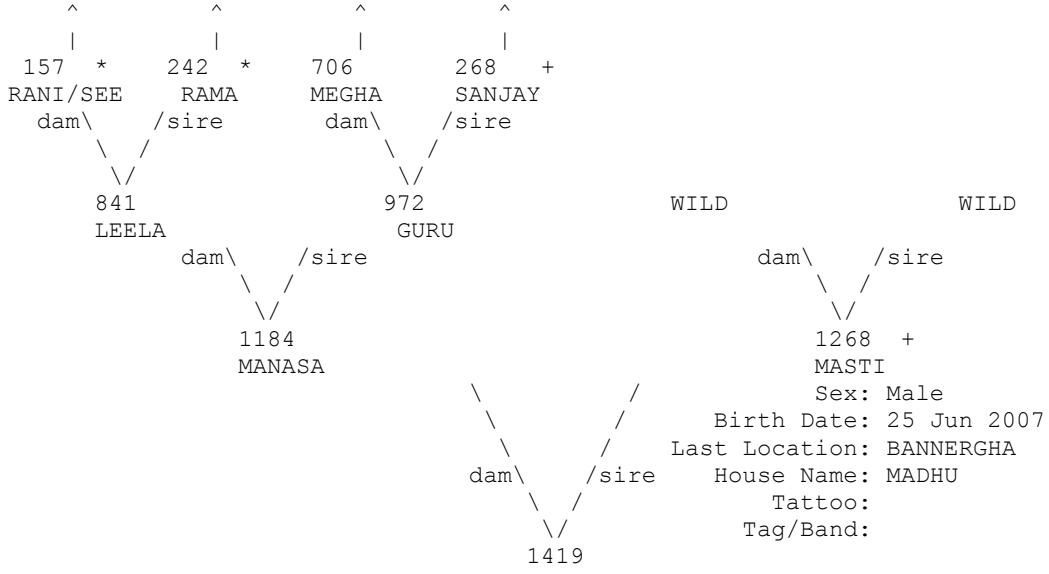

+ Wild-caught... * Appear more than once...
 ^ Pedigree continues beyond top of page...

=====
 Taxon Name: PANTHERA TIGRIS Studbook Number: 1420
 =====

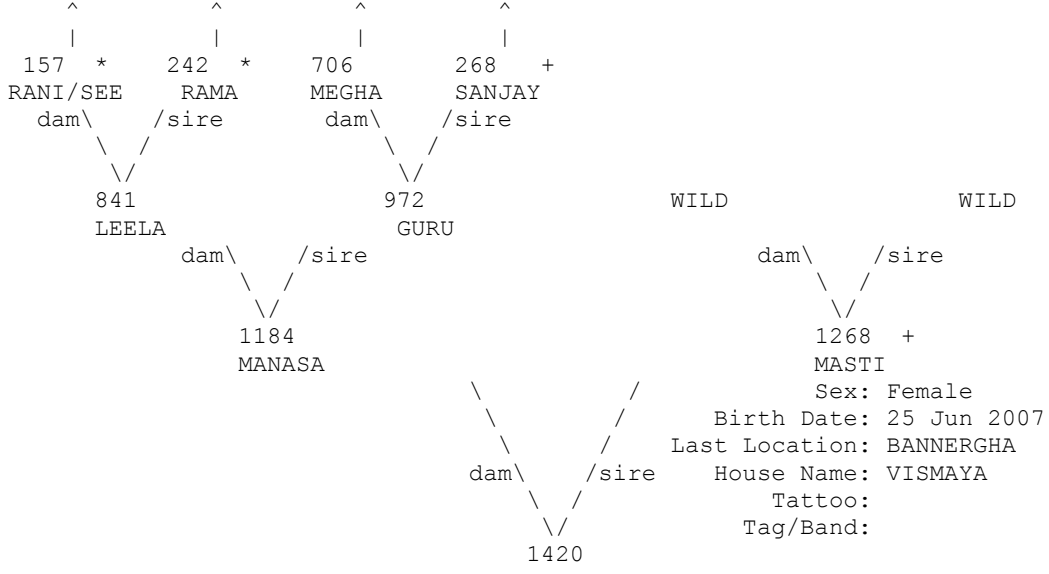

+ Wild-caught... * Appear more than once...
 ^ Pedigree continues beyond top of page...

=====
 Taxon Name: PANTHERA TIGRIS Studbook Number: 1421
 =====

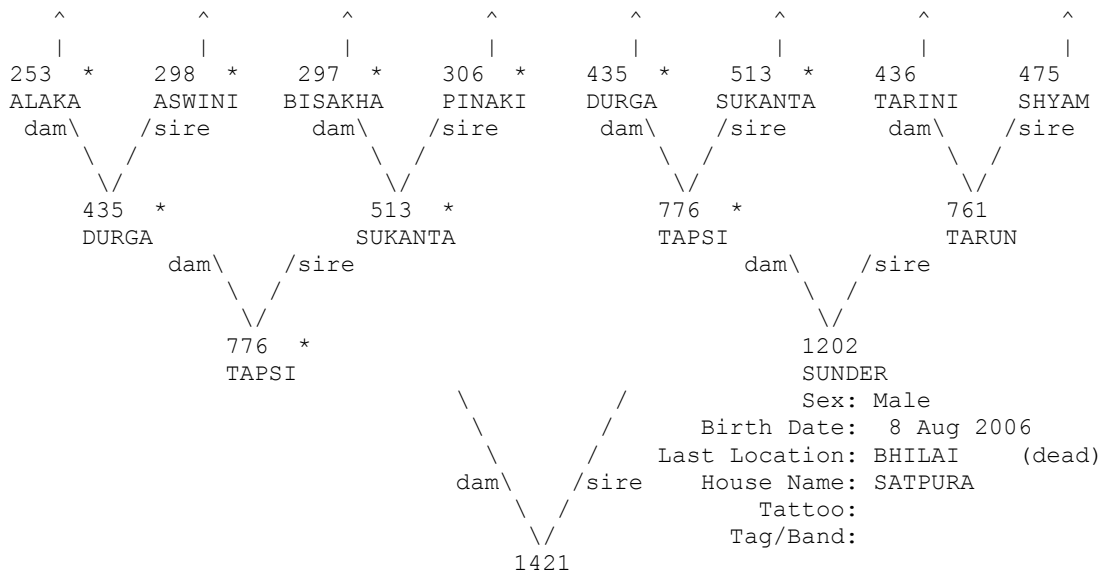

* Appear more than once...
 ^ Pedigree continues beyond top of page...

=====
 Taxon Name: PANTHERA TIGRIS Studbook Number: 1422
 =====

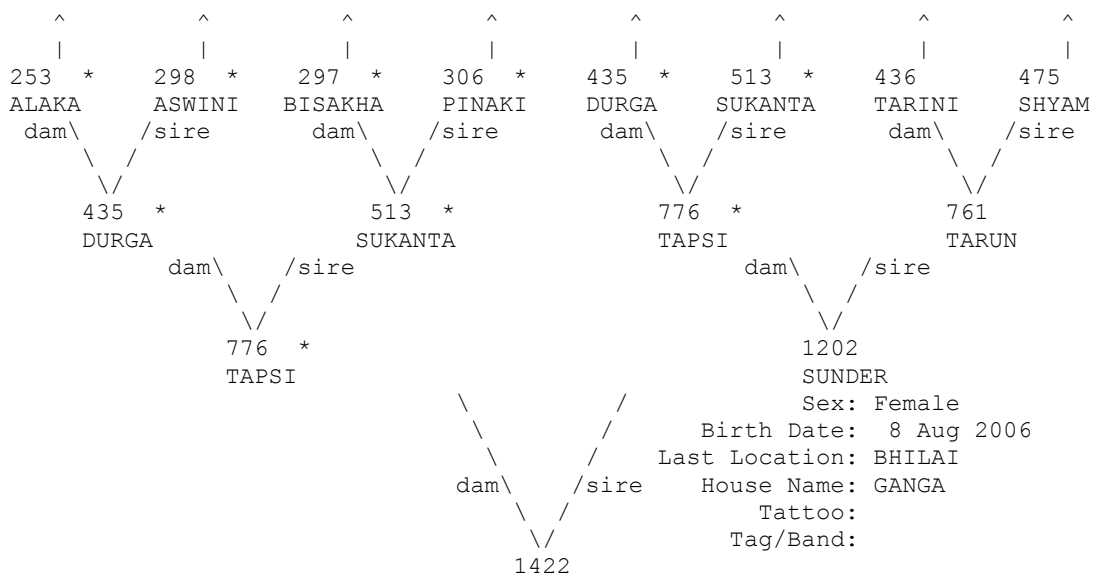

* Appear more than once...
 ^ Pedigree continues beyond top of page...

=====
 Taxon Name: PANTHERA TIGRIS Studbook Number: 1423
 =====

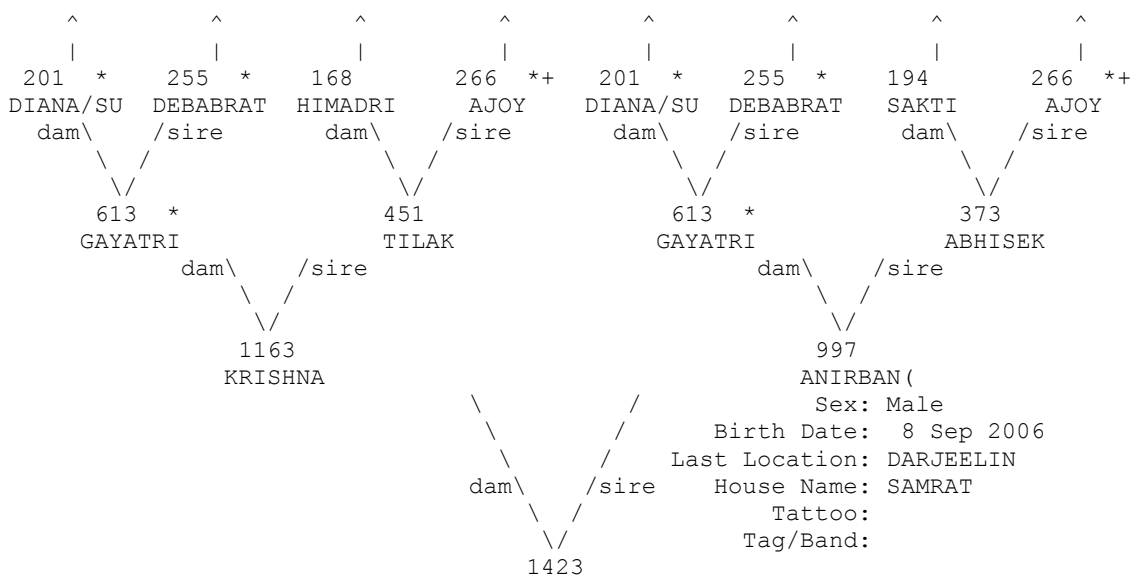

+ Wild-caught... * Appear more than once...
 ^ Pedigree continues beyond top of page...

=====
 Taxon Name: PANTHERA TIGRIS Studbook Number: 1424
 =====

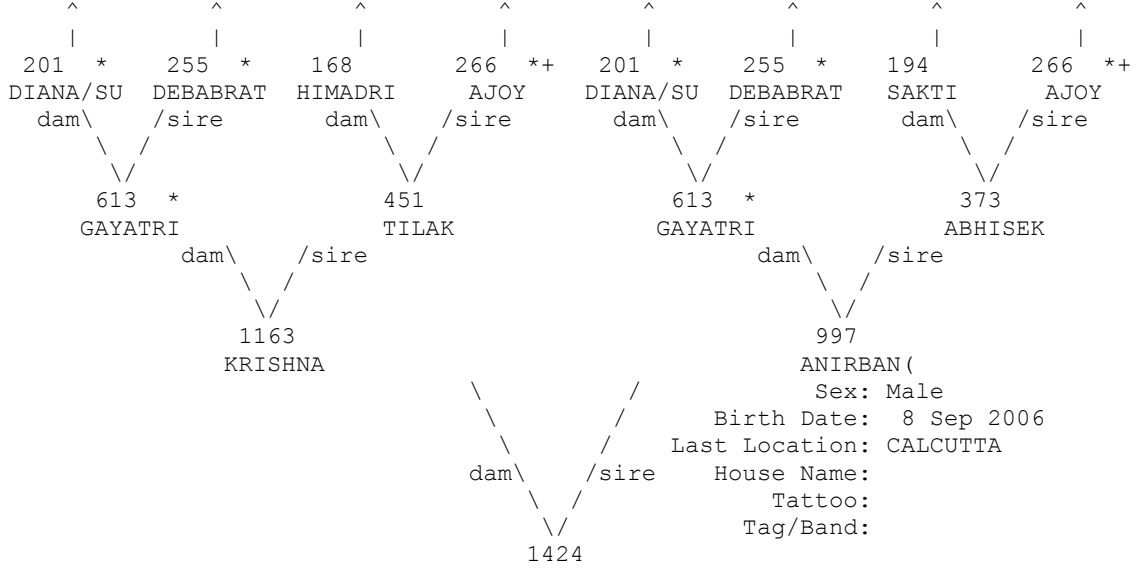

+ Wild-caught... * Appear more than once...
 ^ Pedigree continues beyond top of page...

=====
 Taxon Name: PANTHERA TIGRIS Studbook Number: 1427
 =====

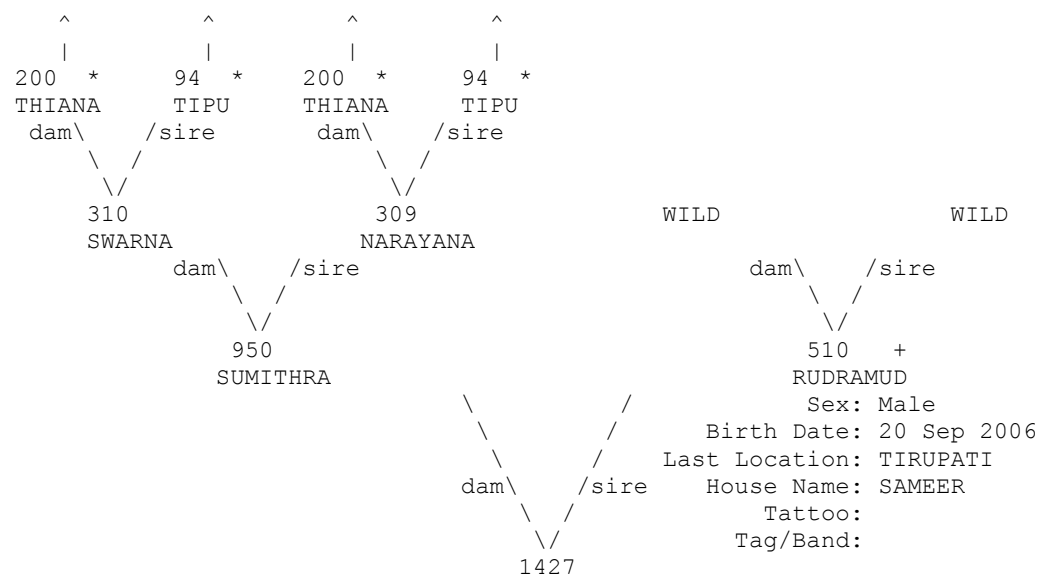

+ Wild-caught... * Appear more than once...
 ^ Pedigree continues beyond top of page...

=====
 Taxon Name: PANTHERA TIGRIS Studbook Number: 1428
 =====

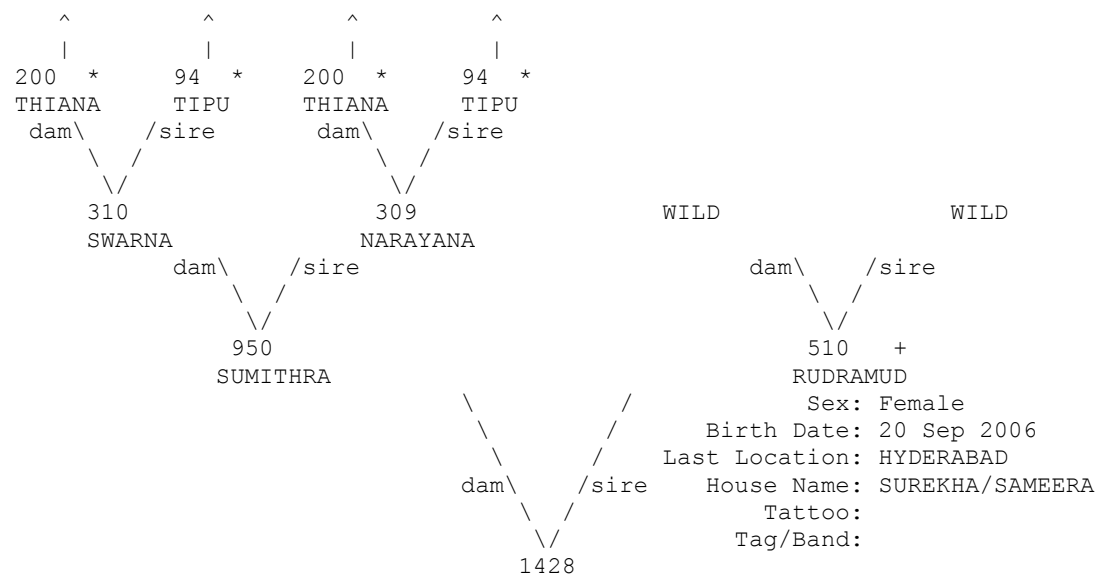

+ Wild-caught... * Appear more than once...
 ^ Pedigree continues beyond top of page...

=====
 Taxon Name: PANTHERA TIGRIS Studbook Number: 1429
 =====

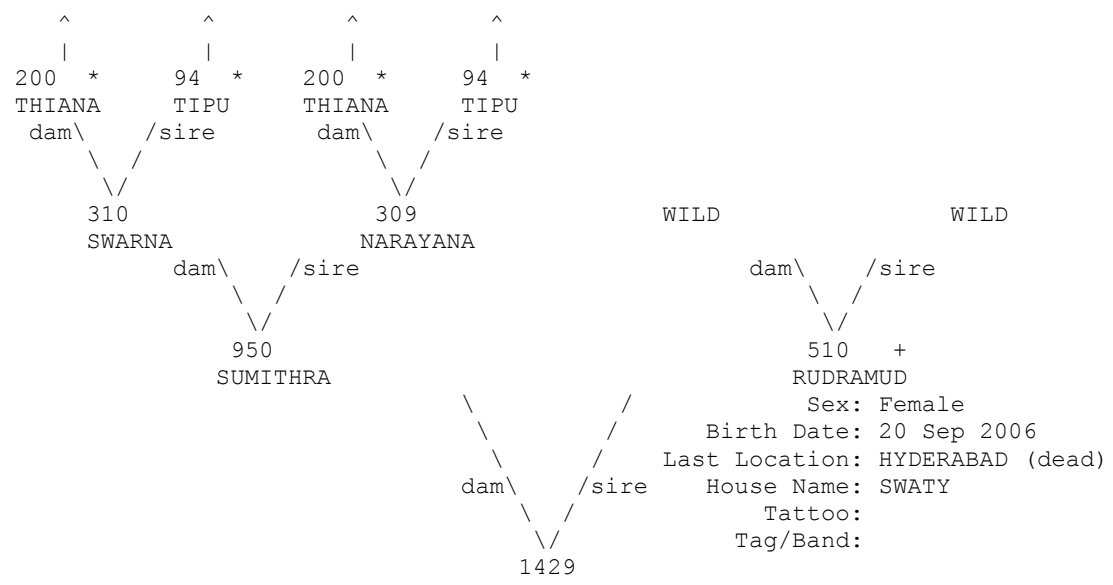

+ Wild-caught... * Appear more than once...
 ^ Pedigree continues beyond top of page...

=====
 Taxon Name: PANTHERA TIGRIS Studbook Number: 1430
 =====

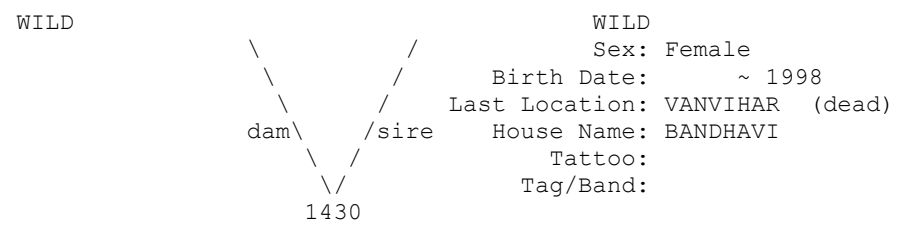

=====
 Taxon Name: PANTHERA TIGRIS Studbook Number: 1431
 =====

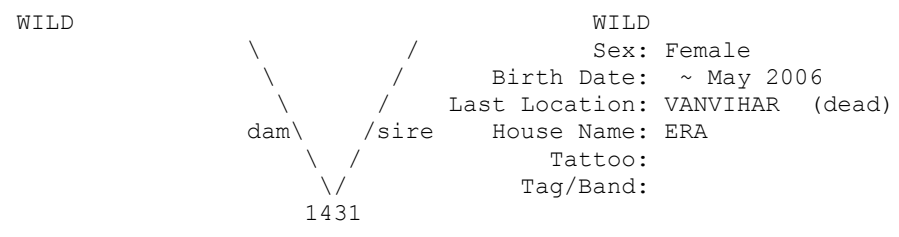

=====
 Taxon Name: PANTHERA TIGRIS Studbook Number: 1432
 =====

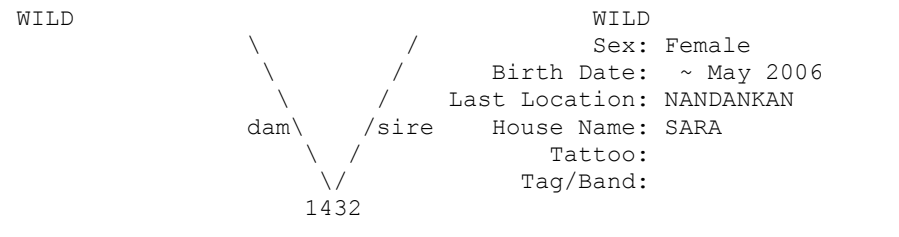

=====
 Taxon Name: PANTHERA TIGRIS Studbook Number: 1435
 =====

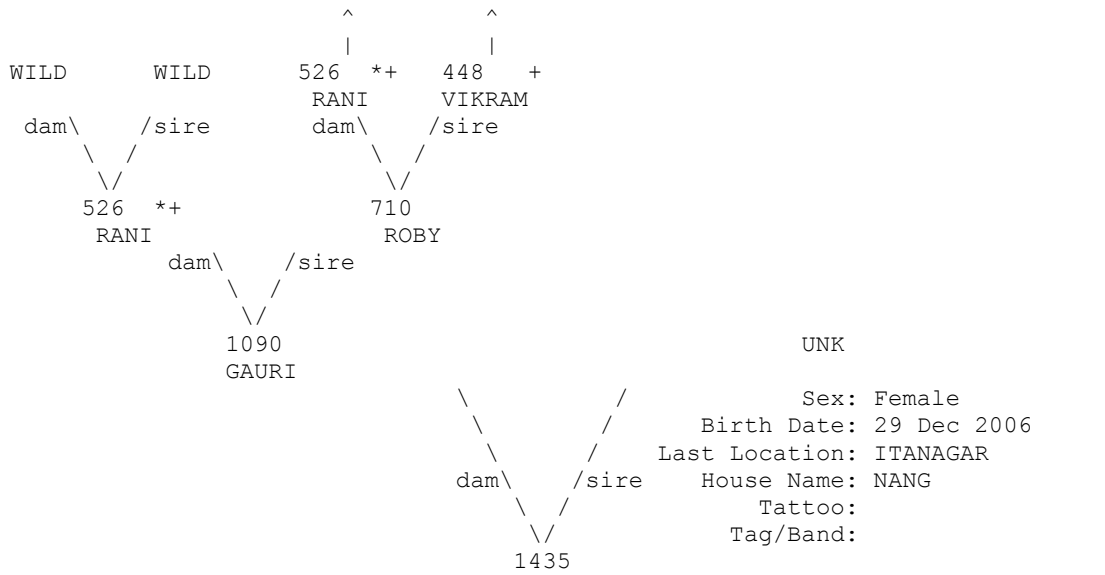

+ Wild-caught... * Appear more than once...
 ^ Pedigree continues beyond top of page...

=====
 Taxon Name: PANTHERA TIGRIS Studbook Number: 1436
 =====

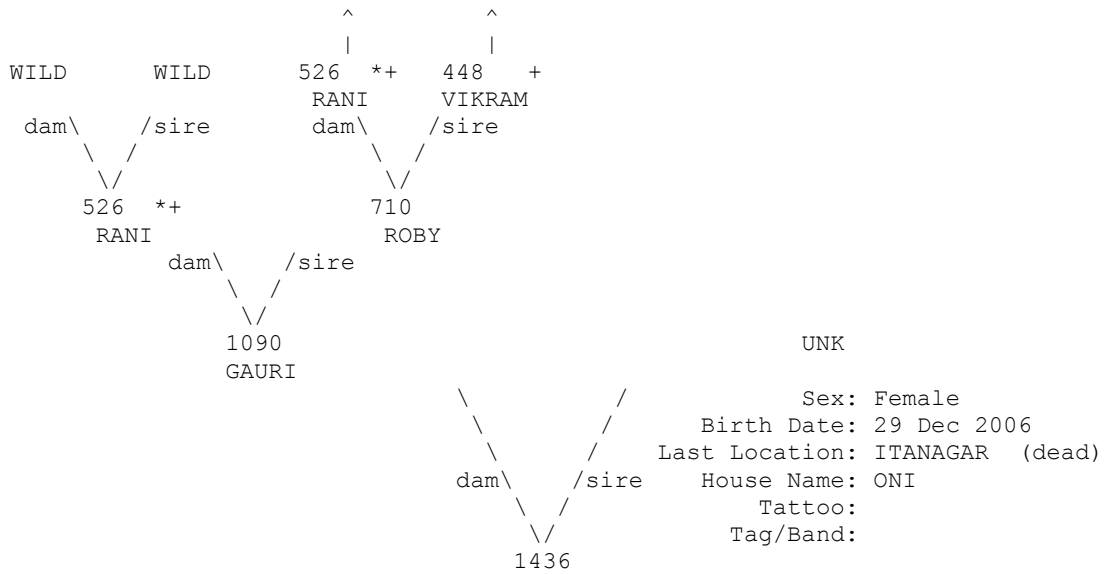

+ Wild-caught... * Appear more than once...
 ^ Pedigree continues beyond top of page...

=====
 Taxon Name: PANTHERA TIGRIS Studbook Number: 1443
 =====

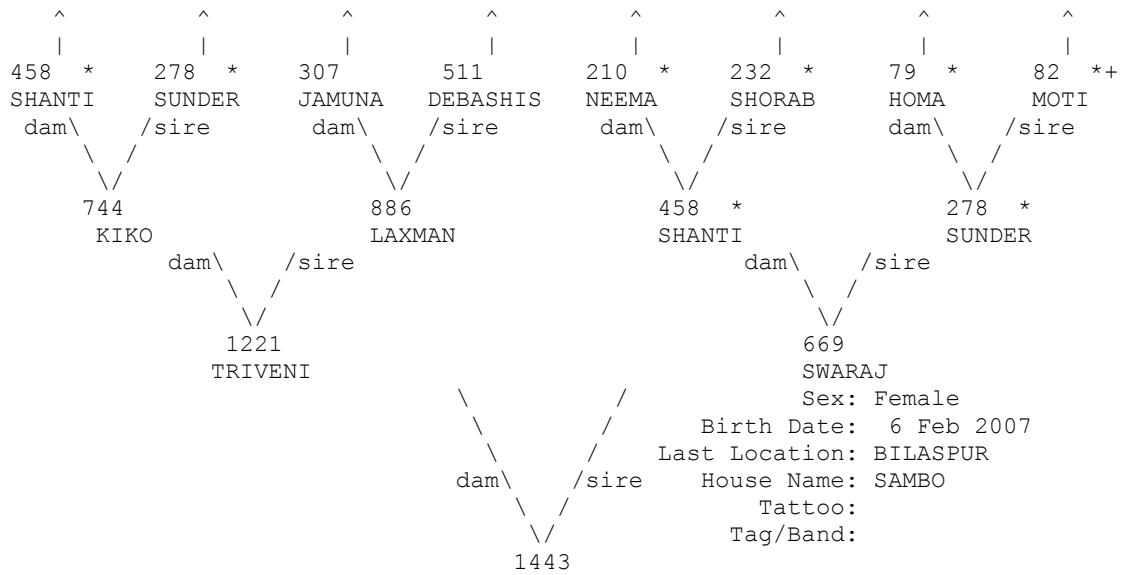

+ Wild-caught... * Appear more than once...
 ^ Pedigree continues beyond top of page...

=====
 Taxon Name: PANTHERA TIGRIS Studbook Number: 1444
 =====

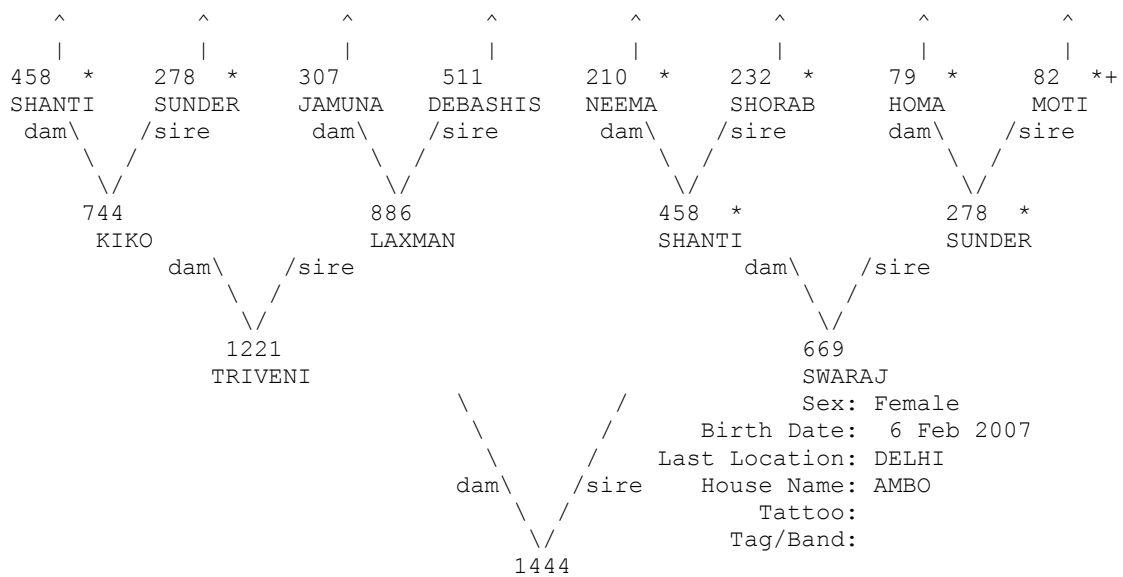

+ Wild-caught... * Appear more than once...
 ^ Pedigree continues beyond top of page...

=====
 Taxon Name: PANTHERA TIGRIS Studbook Number: 1449
 =====

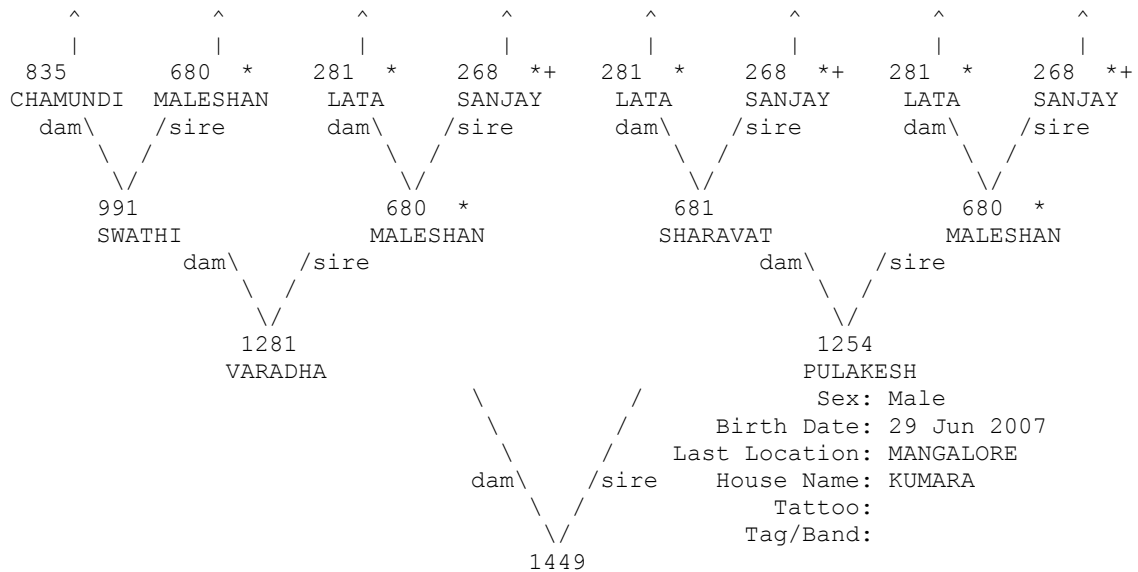

+ Wild-caught... * Appear more than once...
 ^ Pedigree continues beyond top of page...

=====
 Taxon Name: PANTHERA TIGRIS Studbook Number: 1450
 =====

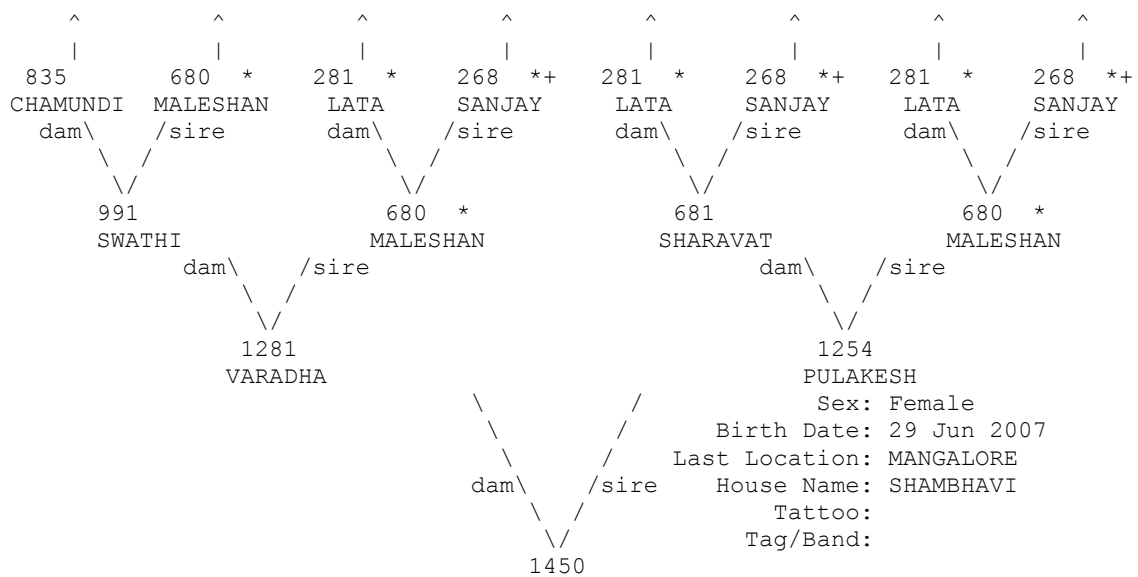

+ Wild-caught... * Appear more than once...
 ^ Pedigree continues beyond top of page...

=====
 Taxon Name: PANTHERA TIGRIS Studbook Number: 1451
 =====

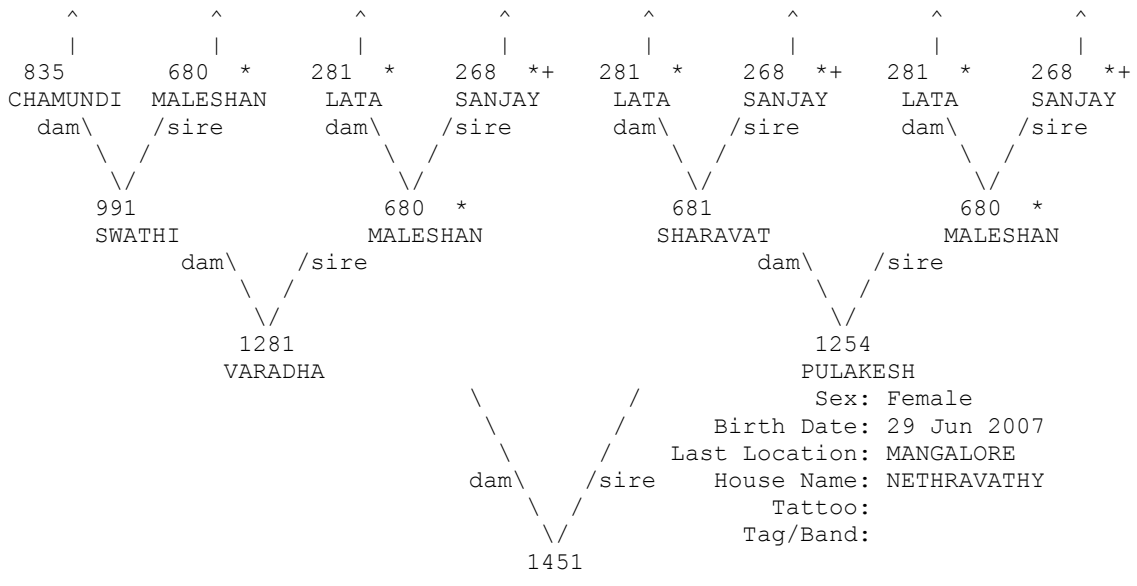

+ Wild-caught... * Appear more than once...
 ^ Pedigree continues beyond top of page...

=====
 Taxon Name: PANTHERA TIGRIS Studbook Number: 1452
 =====

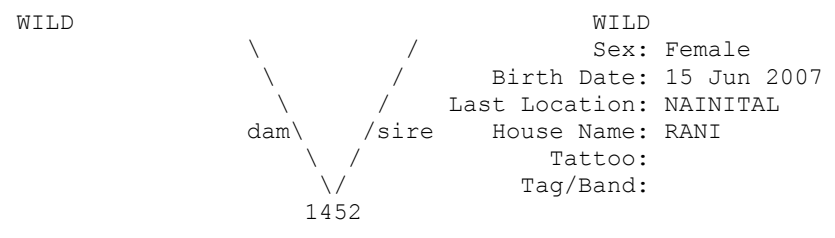

=====
 Taxon Name: PANTHERA TIGRIS Studbook Number: 1453
 =====

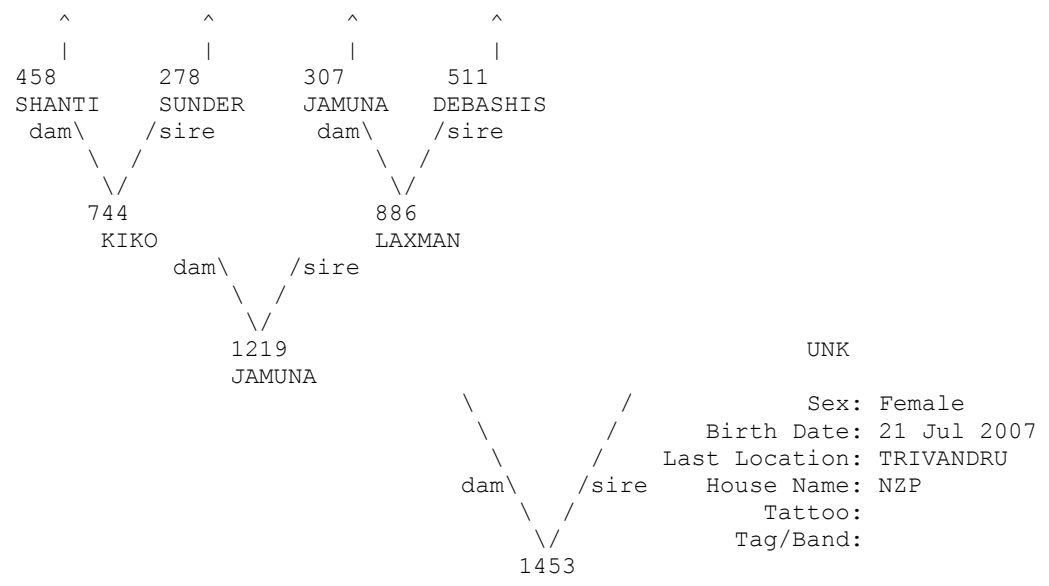

* Appear more than once...
 ^ Pedigree continues beyond top of page...

=====
 Taxon Name: PANTHERA TIGRIS Studbook Number: 1454
 =====

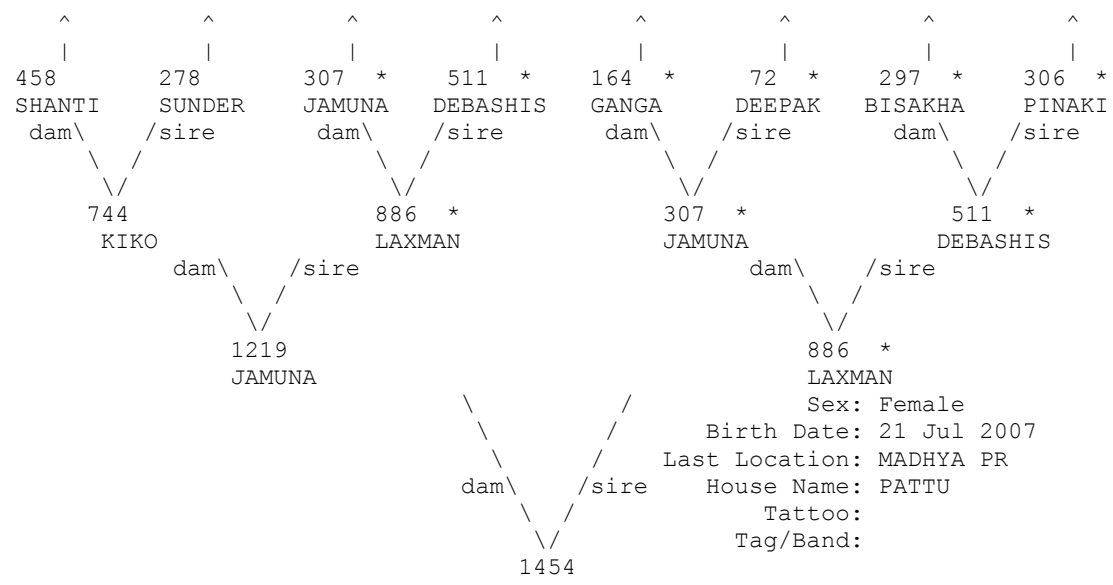

* Appear more than once...
 ^ Pedigree continues beyond top of page...

=====
 Taxon Name: PANTHERA TIGRIS Studbook Number: 1455
 =====

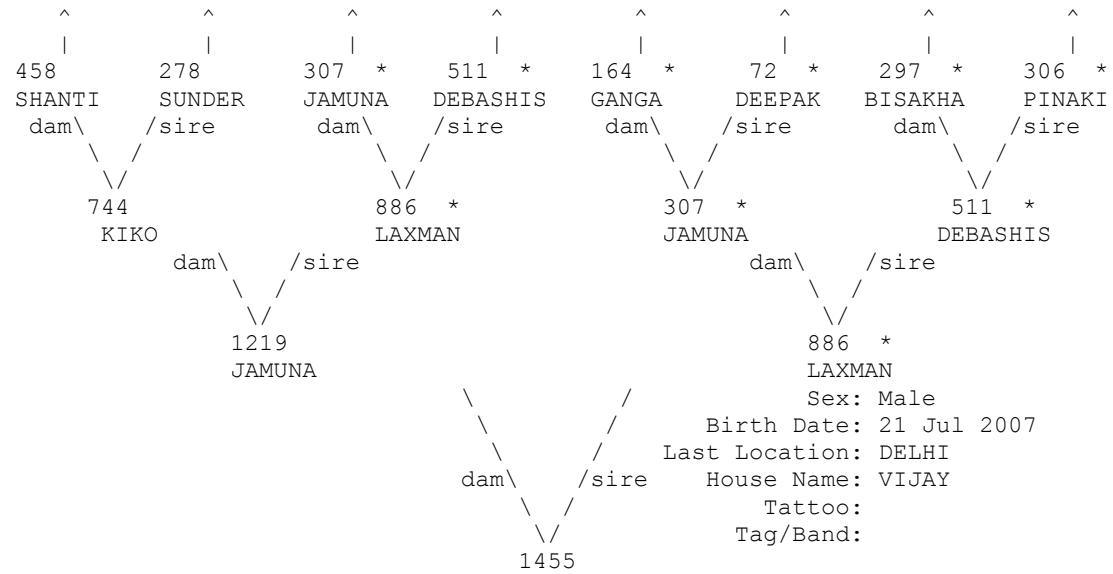

* Appear more than once...
 ^ Pedigree continues beyond top of page...

=====
 Taxon Name: PANTHERA TIGRIS Studbook Number: 1459
 =====

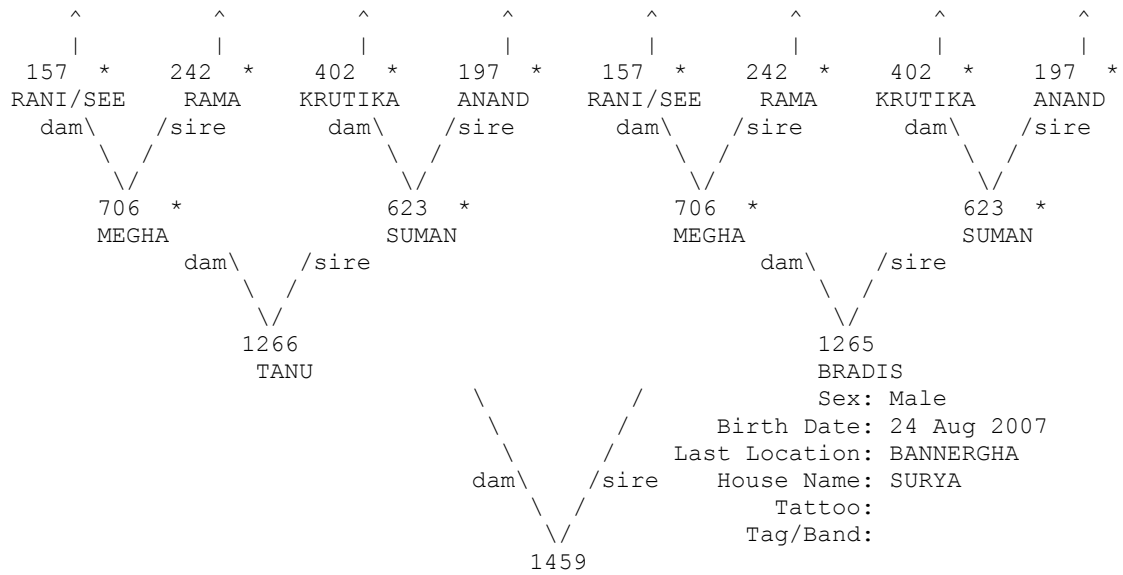

* Appear more than once...
 ^ Pedigree continues beyond top of page...

=====
 Taxon Name: PANTHERA TIGRIS Studbook Number: 1460
 =====

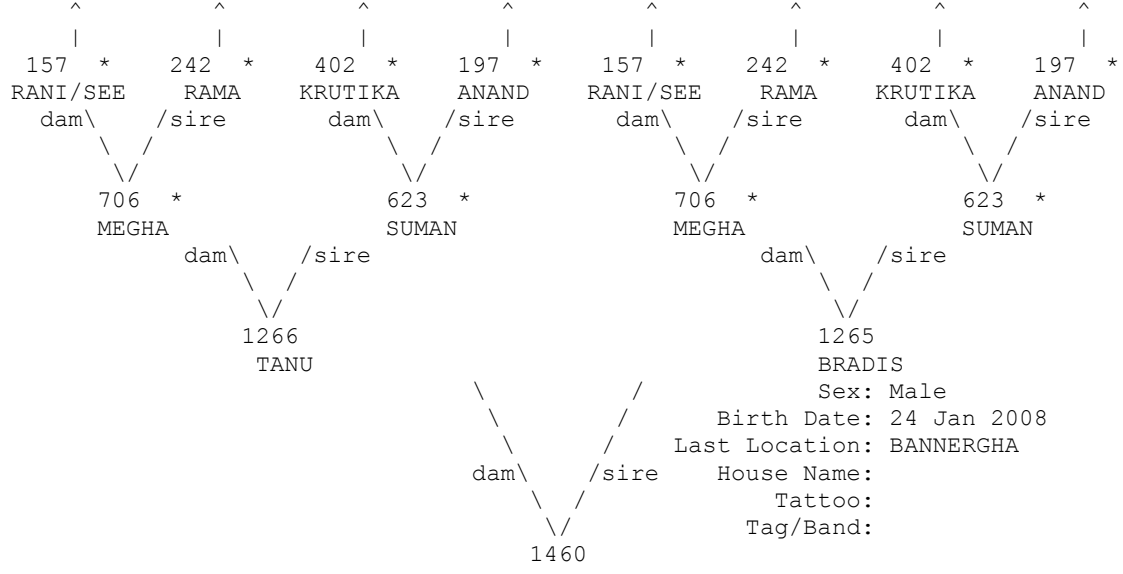

* Appear more than once...
 ^ Pedigree continues beyond top of page...

=====
 Taxon Name: PANTHERA TIGRIS Studbook Number: 1461
 =====

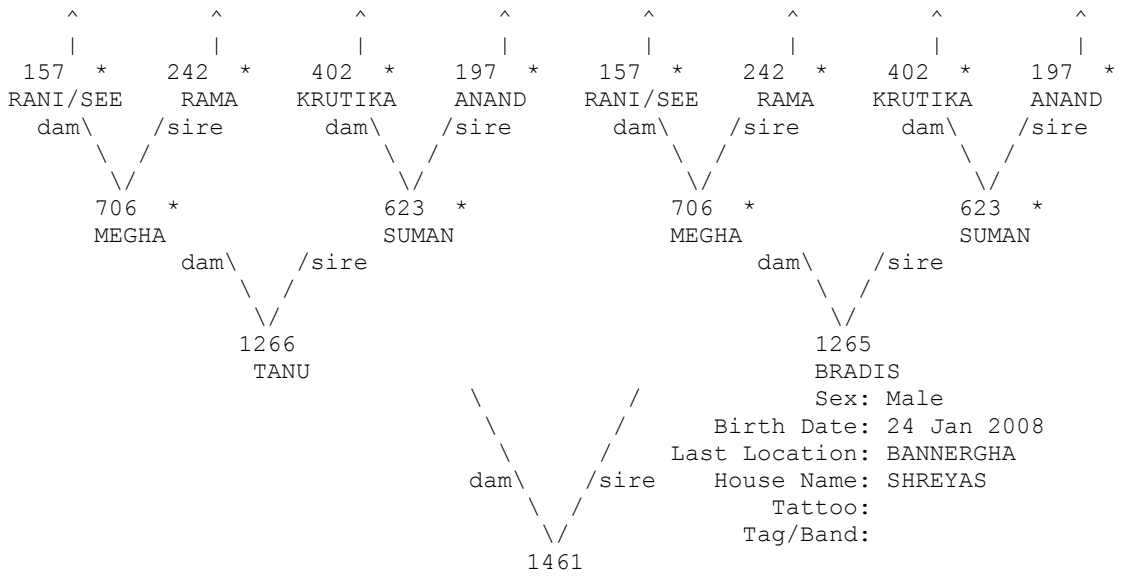

* Appear more than once...
 ^ Pedigree continues beyond top of page...

=====
 Taxon Name: PANTHERA TIGRIS Studbook Number: 1462
 =====

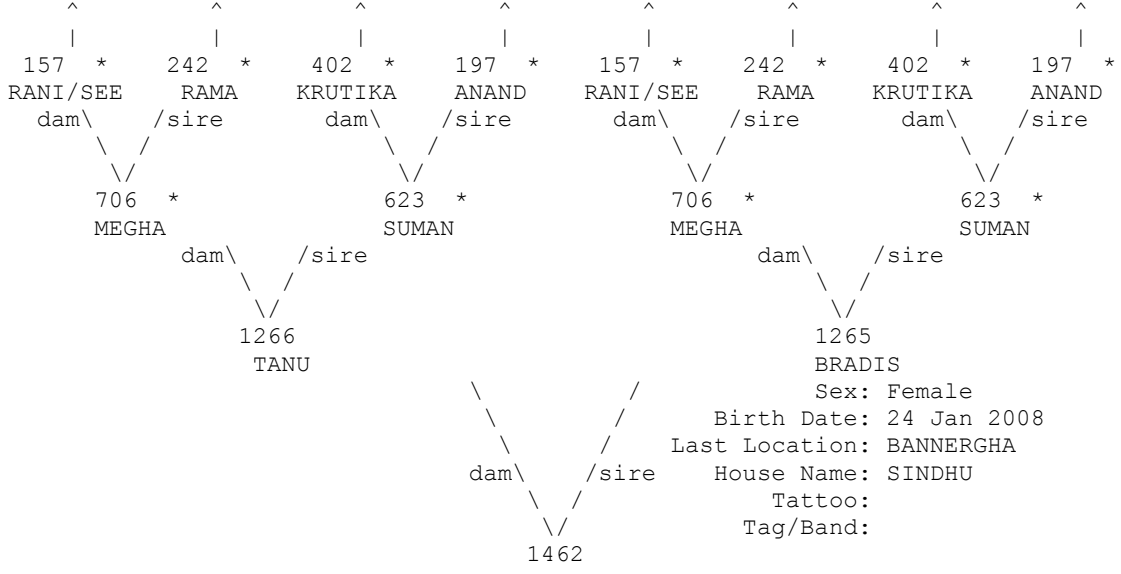

* Appear more than once...
 ^ Pedigree continues beyond top of page...

=====
 Taxon Name: PANTHERA TIGRIS Studbook Number: 1465
 =====

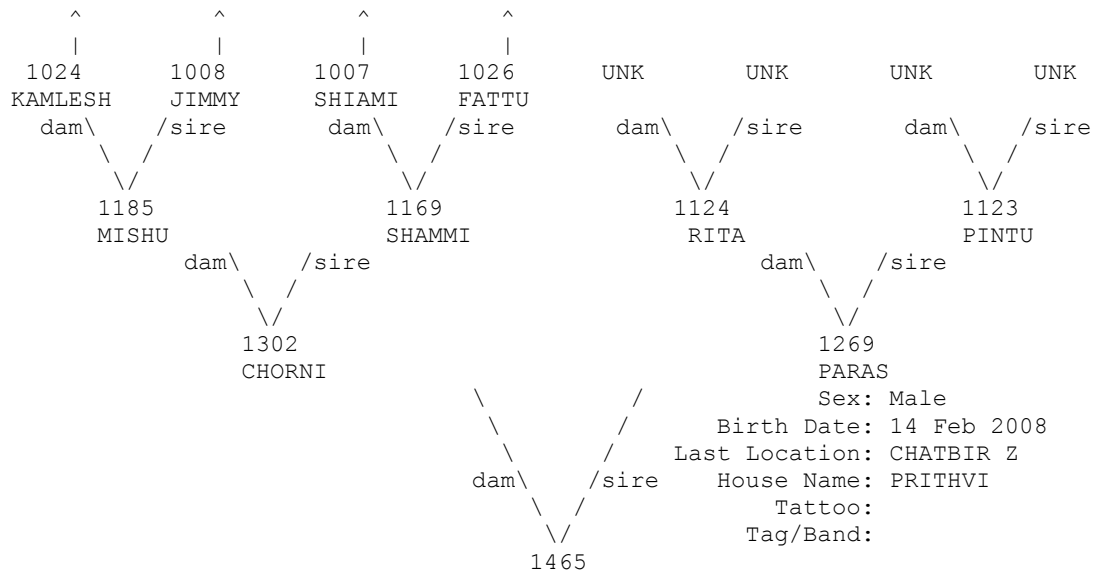

* Appear more than once...
 ^ Pedigree continues beyond top of page...

=====
 Taxon Name: PANTHERA TIGRIS Studbook Number: 1466
 =====

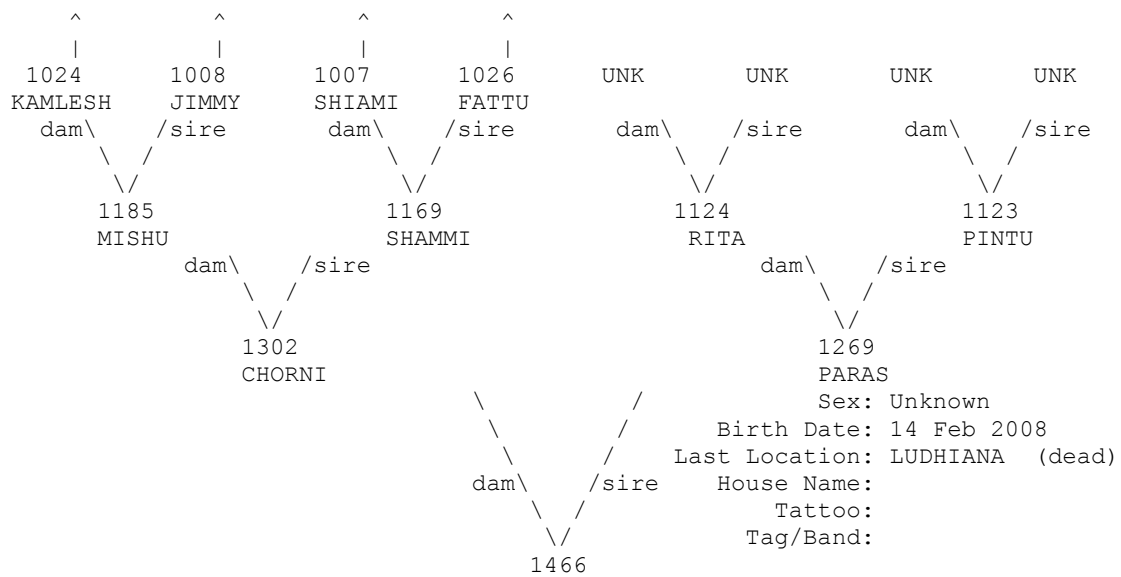

* Appear more than once...
 ^ Pedigree continues beyond top of page...

=====
 Taxon Name: PANTHERA TIGRIS Studbook Number: 1467
 =====

WILD

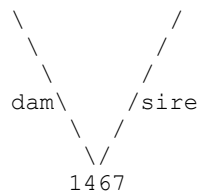

WILD
 Sex: Male
 Birth Date: ????
 Last Location: VANVIHAR (dead)
 House Name: SATNA
 Tattoo:
 Tag/Band:

=====
 Taxon Name: PANTHERA TIGRIS Studbook Number: 1468
 =====

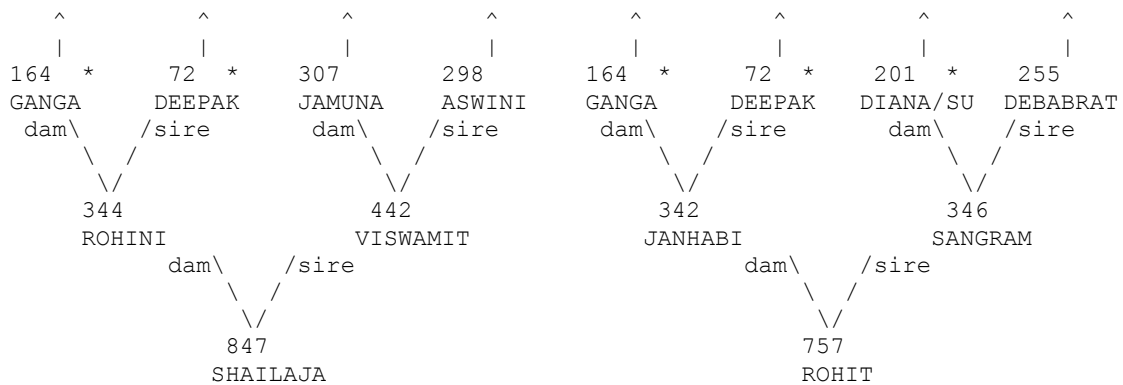

Sex: Male
 Birth Date: 28 Feb 2008
 Last Location: NANDANKAN
 House Name: MANISH
 Tattoo:
 Tag/Band:

* Appear more than once...
 ^ Pedigree continues beyond top of page...

=====
 Taxon Name: PANTHERA TIGRIS Studbook Number: 1469
 =====

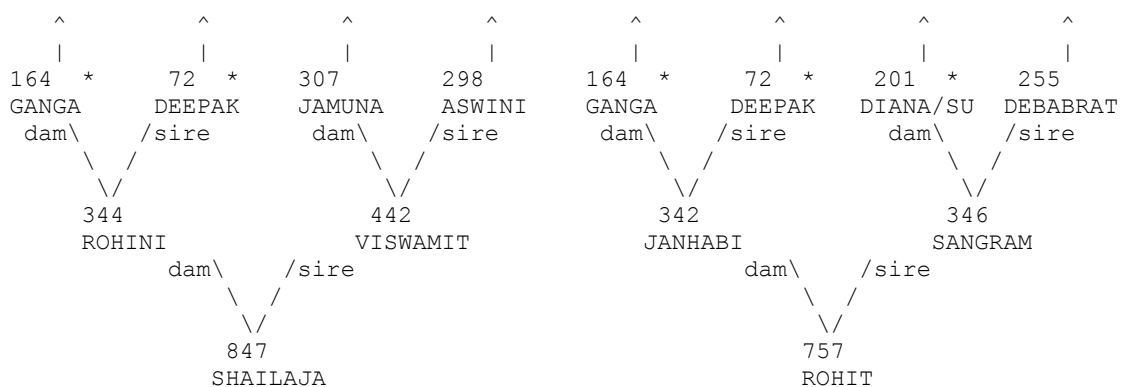

Sex: Female
 Birth Date: 28 Feb 2008
 Last Location: NANDANKAN
 House Name: RENUKA
 Tattoo:
 Tag/Band:

* Appear more than once...
 ^ Pedigree continues beyond top of page...

=====
 Taxon Name: PANTHERA TIGRIS Studbook Number: 1470
 =====

WILD

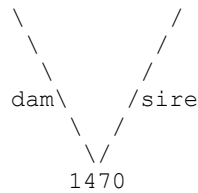

WILD
 Sex: Male
 Birth Date: ~ 2000
 Last Location: MYSORE
 House Name: BRAHMA
 Tattoo:
 Tag/Band:

=====
 Taxon Name: PANTHERA TIGRIS Studbook Number: 1471
 =====

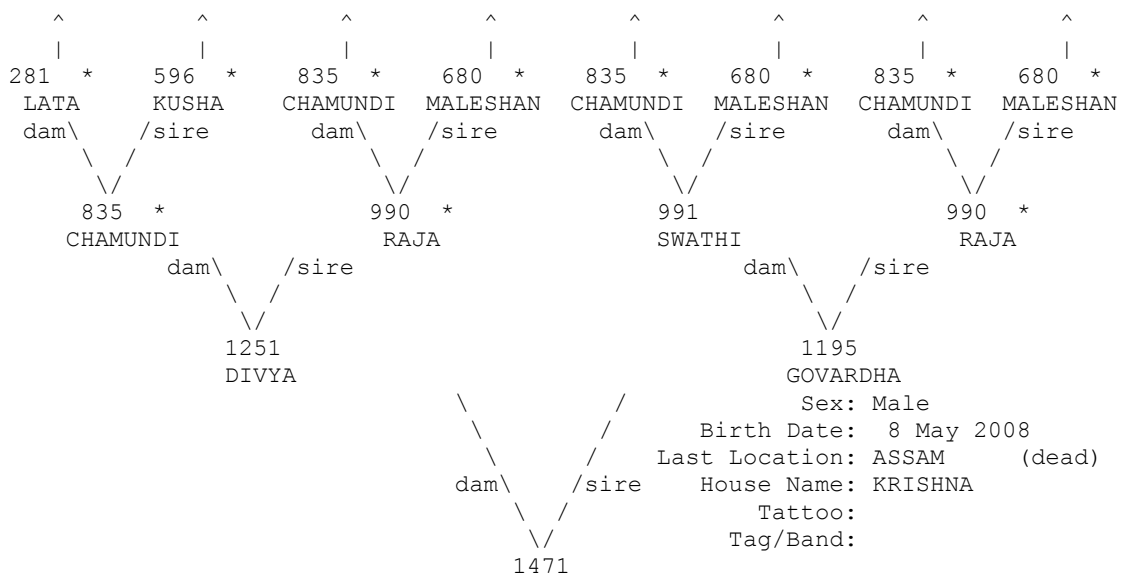

Sex: Male
 Birth Date: 8 May 2008
 Last Location: ASSAM (dead)
 House Name: KRISHNA
 Tattoo:
 Tag/Band:

* Appear more than once...
 ^ Pedigree continues beyond top of page...

=====
 Taxon Name: PANTHERA TIGRIS Studbook Number: 1472
 =====

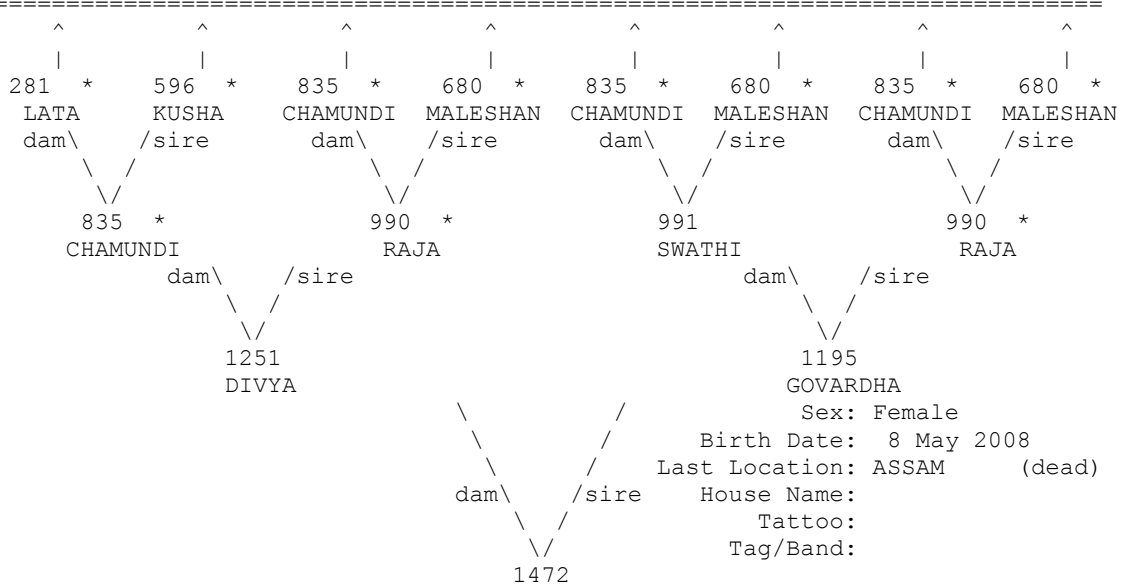

Sex: Female
 Birth Date: 8 May 2008
 Last Location: ASSAM (dead)
 House Name:
 Tattoo:
 Tag/Band:

* Appear more than once...
 ^ Pedigree continues beyond top of page...

=====
 Taxon Name: PANTHERA TIGRIS Studbook Number: 1473
 =====

WILD WILD
 dam \ /
 \ /
 sire
 1473
 Sex: Male
 Birth Date: ~ 2005
 Last Location: VANVIHAR (dead)
 House Name: KANHA
 Tattoo:
 Tag/Band:

=====
 Taxon Name: PANTHERA TIGRIS Studbook Number: 1474
 =====

UNK UNK
 dam \ /
 \ /
 sire
 1474
 Sex: Female
 Birth Date: ~ 2008
 Last Location: TIRUPATI
 House Name: RAMYA
 Tattoo:
 Tag/Band:

=====
 Taxon Name: PANTHERA TIGRIS Studbook Number: 1475
 =====

WILD WILD WILD WILD WILD WILD
 dam \ / dam \ / dam \ / dam \ / dam \ / dam \ /
 \ / \ / \ / \ / \ / \ /
 sire sire sire sire sire sire
 1291 + 640 864 +
 BASANI RINI PALASH RAM
 Sex: Male
 Birth Date: 8 Oct 2008
 Last Location: BORIVILLI
 House Name: YASH
 Tattoo:
 Tag/Band:
 1475

297 306
 BISAKHA PINAKI
 dam \ / dam \ /
 \ / \ /
 sire sire
 640 864 +
 RINI PALASH RAM
 Sex: Male
 Birth Date: 8 Oct 2008
 Last Location: BORIVILLI
 House Name: YASH
 Tattoo:
 Tag/Band:

^ ^
 | |
 297 306
 BISAKHA PINAKI
 dam \ / dam \ /
 \ / \ /
 sire sire
 640 864 +
 RINI PALASH RAM
 Sex: Male
 Birth Date: 8 Oct 2008
 Last Location: BORIVILLI
 House Name: YASH
 Tattoo:
 Tag/Band:

+ Wild-caught... * Appear more than once...
 ^ Pedigree continues beyond top of page...

=====
 Taxon Name: PANTHERA TIGRIS Studbook Number: 1478
 =====

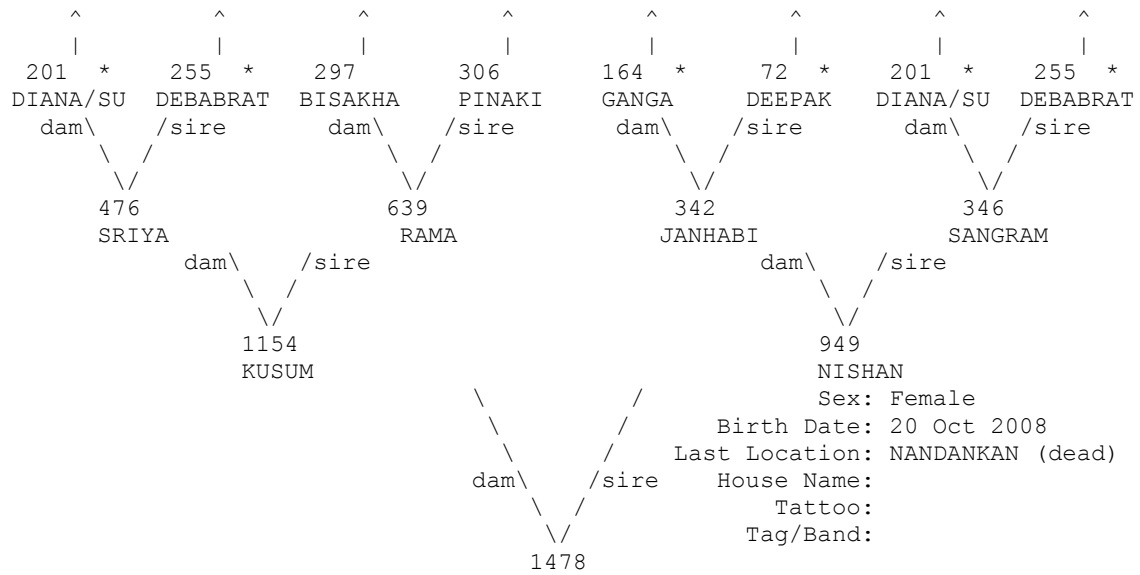

* Appear more than once...
 ^ Pedigree continues beyond top of page...

=====
 Taxon Name: PANTHERA TIGRIS Studbook Number: 1479
 =====

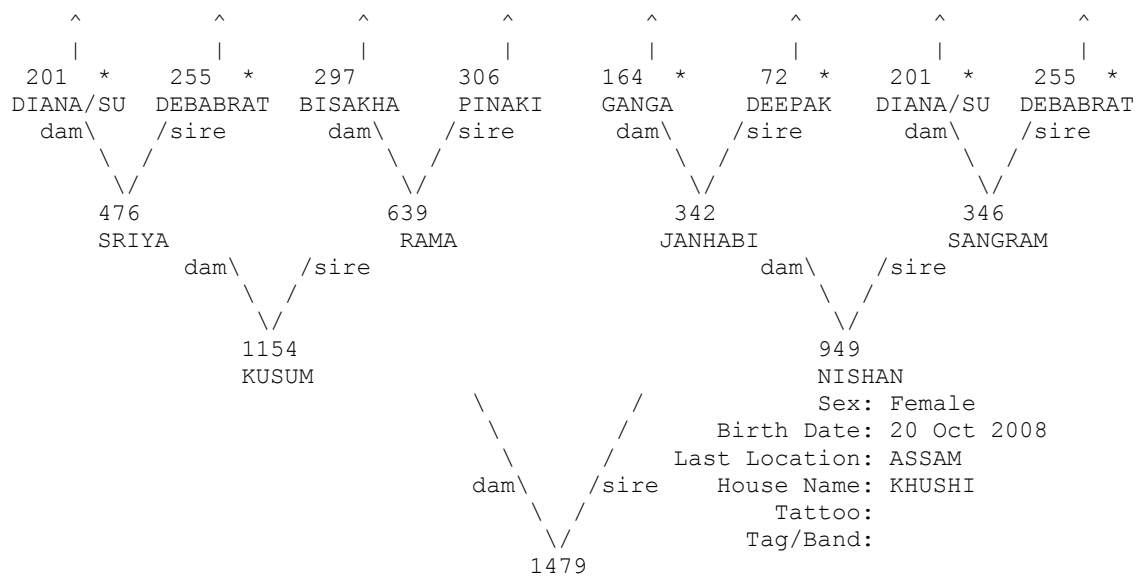

* Appear more than once...
 ^ Pedigree continues beyond top of page...

=====
 Taxon Name: PANTHERA TIGRIS Studbook Number: 1480
 =====

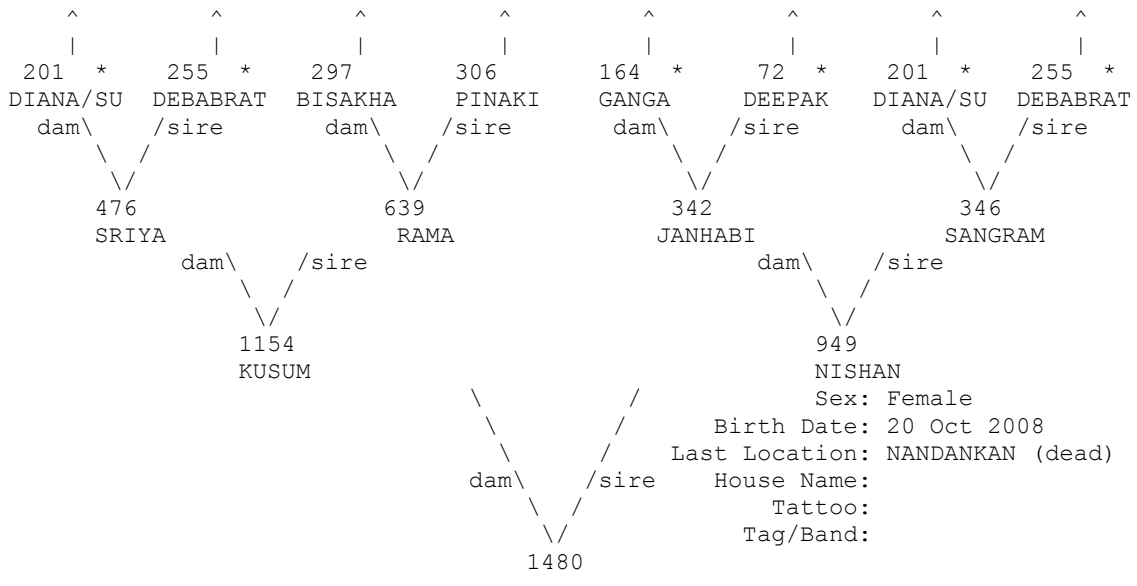

* Appear more than once...
 ^ Pedigree continues beyond top of page...

=====
 Taxon Name: PANTHERA TIGRIS Studbook Number: 1481
 =====

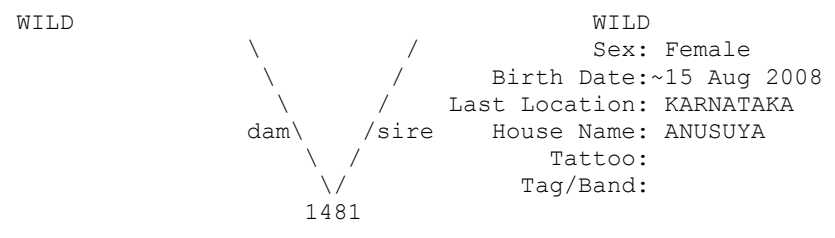

=====
 Taxon Name: PANTHERA TIGRIS Studbook Number: 1482
 =====

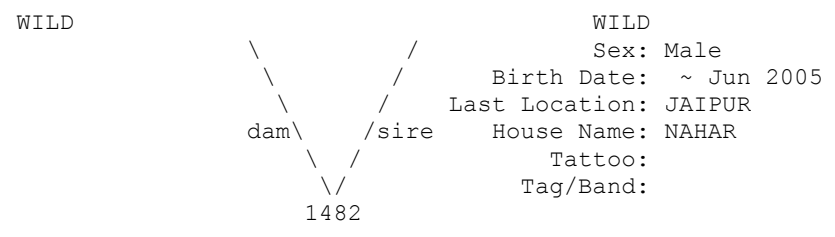

=====
 Taxon Name: PANTHERA TIGRIS Studbook Number: 1489
 =====

WILD

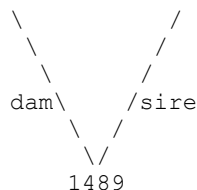

WILD
 Sex: Female
 Birth Date: ????
 Last Location: VANVIHAR (dead)
 House Name: RANI
 Tattoo:
 Tag/Band:

=====
 Taxon Name: PANTHERA TIGRIS Studbook Number: 1490
 =====

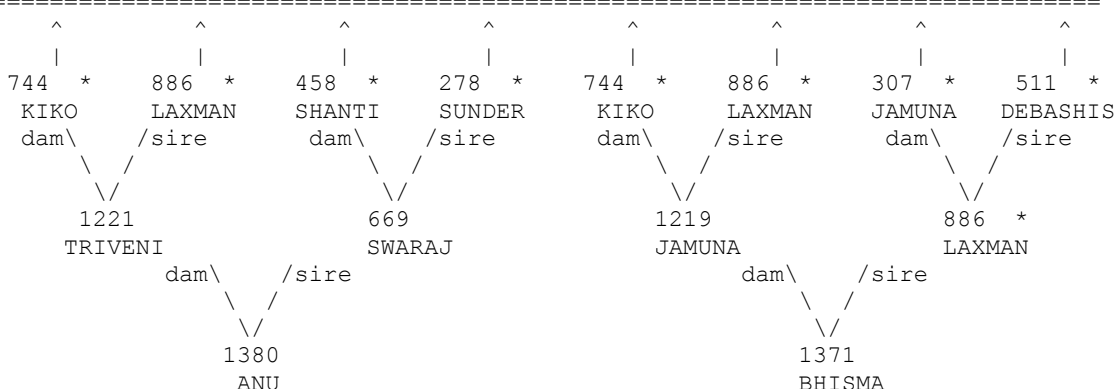

Sex: Female
 Birth Date: 24 Mar 2009
 Last Location: MADRAS
 House Name: AKANSHA
 Tattoo:
 Tag/Band:

* Appear more than once...
 ^ Pedigree continues beyond top of page...

=====
 Taxon Name: PANTHERA TIGRIS Studbook Number: 1491
 =====

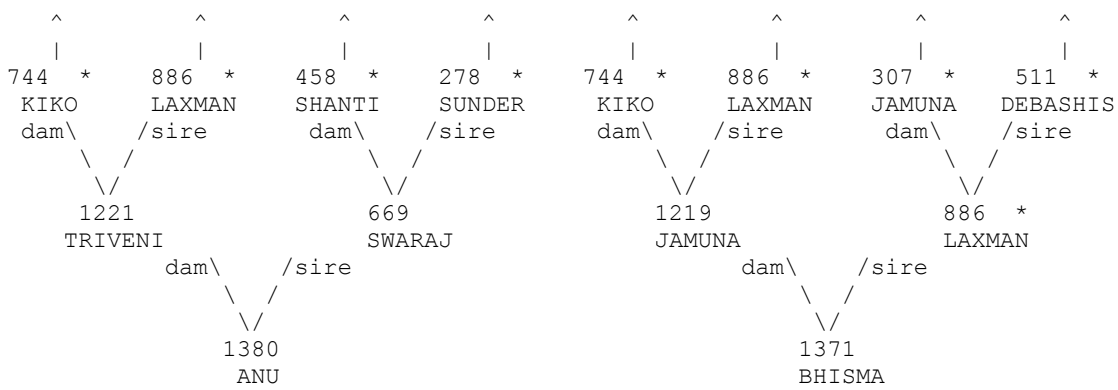

Sex: Female
 Birth Date: 24 Mar 2009
 Last Location: MADRAS
 House Name: NAMRUTHA
 Tattoo:
 Tag/Band:

* Appear more than once...
 ^ Pedigree continues beyond top of page...

=====
 Taxon Name: PANTHERA TIGRIS Studbook Number: 1492
 =====

WILD

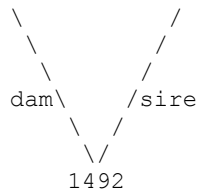

WILD
 Sex: Male
 Birth Date: ????
 Last Location: VANVIHAR (dead)
 House Name: PANCHAM
 Tattoo:
 Tag/Band:

=====
 Taxon Name: PANTHERA TIGRIS Studbook Number: 1494
 =====

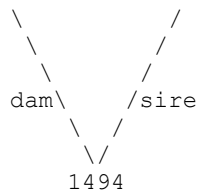
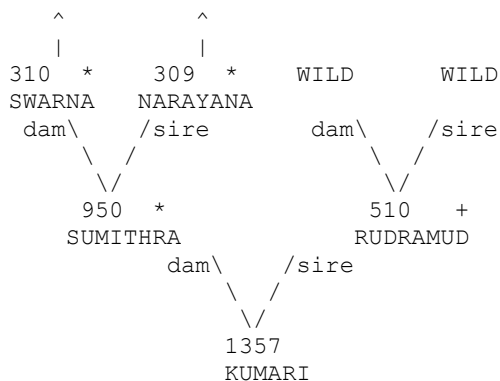

WILD WILD
 Sex: Male
 Birth Date: 13 Apr 2009
 Last Location: VISAKAPAT
 House Name: GIRI
 Tattoo:
 Tag/Band:

+ Wild-caught... * Appear more than once...
 ^ Pedigree continues beyond top of page...

=====
 Taxon Name: PANTHERA TIGRIS Studbook Number: 1495
 =====

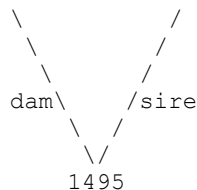
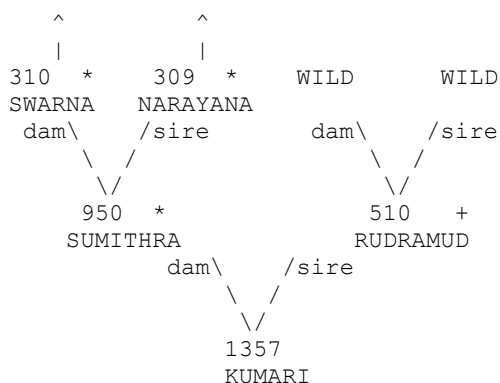

WILD WILD
 Sex: Female
 Birth Date: 13 Apr 2009
 Last Location: VISAKAPAT
 House Name: VANI
 Tattoo:
 Tag/Band:

+ Wild-caught... * Appear more than once...
 ^ Pedigree continues beyond top of page...

=====
 Taxon Name: PANTHERA TIGRIS Studbook Number: 1496
 =====

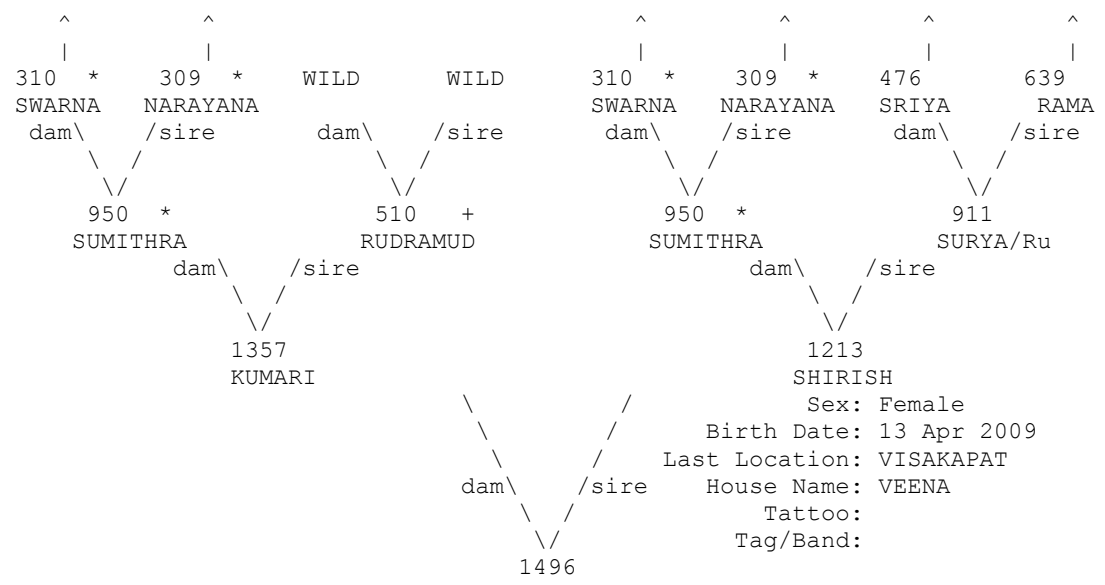

+ Wild-caught... * Appear more than once...
 ^ Pedigree continues beyond top of page...

=====
 Taxon Name: PANTHERA TIGRIS Studbook Number: 1497
 =====

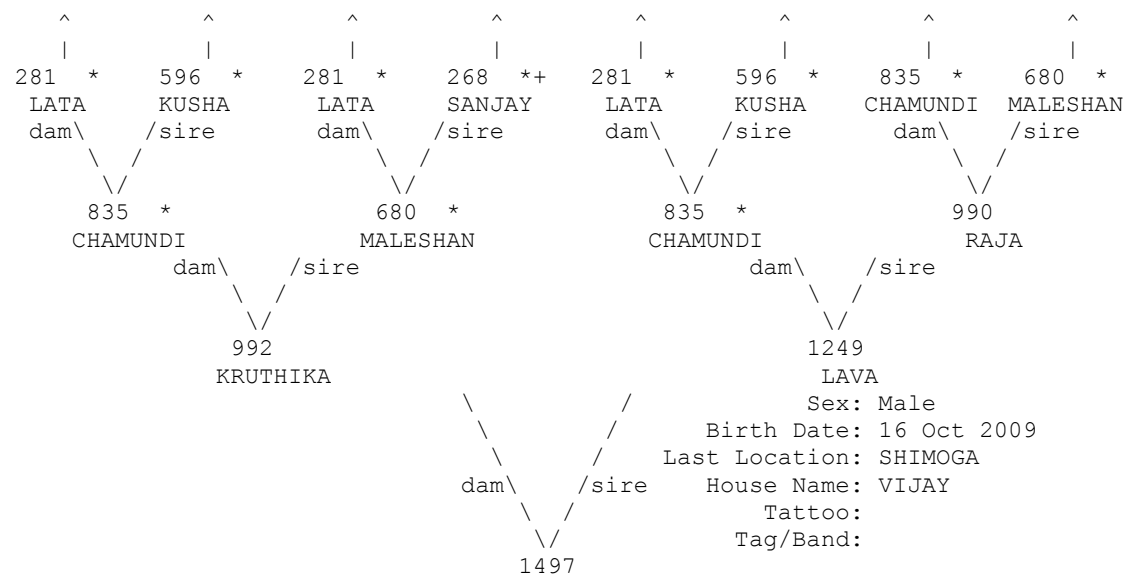

+ Wild-caught... * Appear more than once...
 ^ Pedigree continues beyond top of page...

=====
 Taxon Name: PANTHERA TIGRIS Studbook Number: 1498
 =====

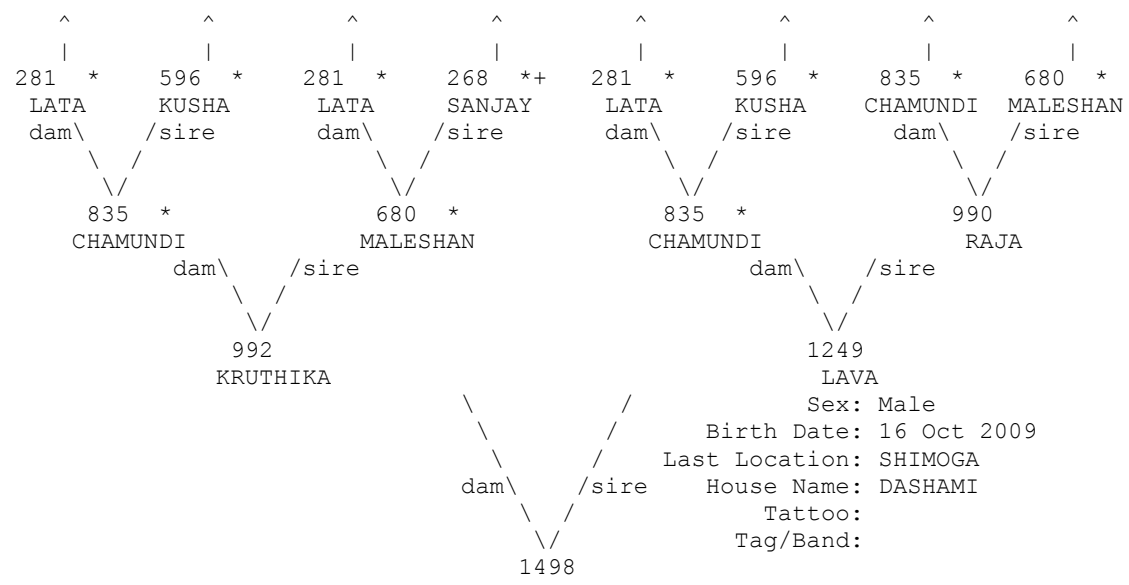

Sex: Male
 Birth Date: 16 Oct 2009
 Last Location: SHIMOGA
 House Name: DASHAMI
 Tattoo:
 Tag/Band:

+ Wild-caught... * Appear more than once...
 ^ Pedigree continues beyond top of page...

=====
 Taxon Name: PANTHERA TIGRIS Studbook Number: 1499
 =====

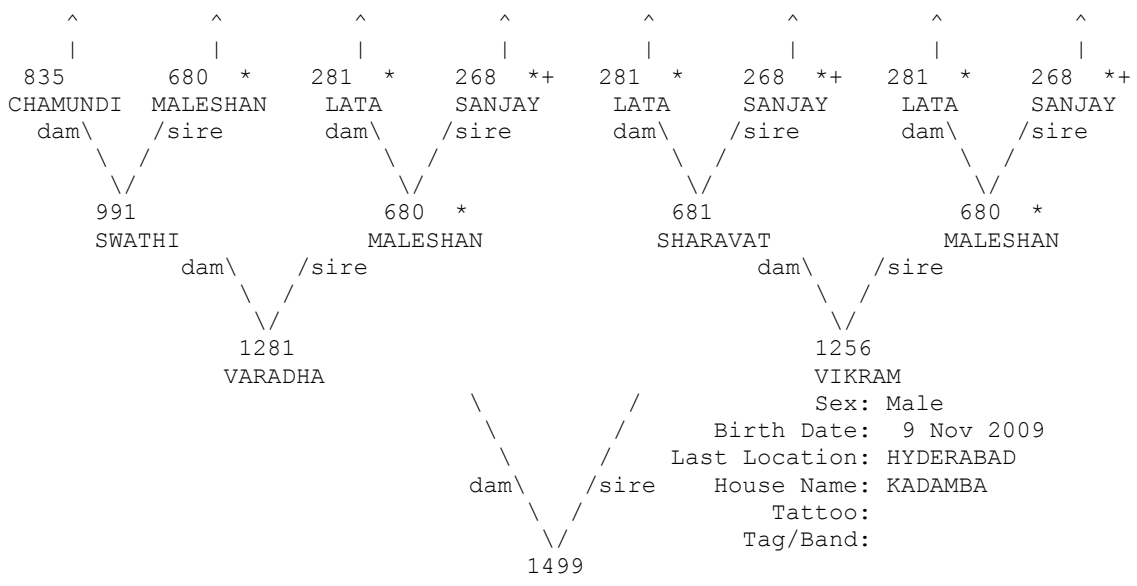

Sex: Male
 Birth Date: 9 Nov 2009
 Last Location: HYDERABAD
 House Name: KADAMBA
 Tattoo:
 Tag/Band:

+ Wild-caught... * Appear more than once...
 ^ Pedigree continues beyond top of page...

=====
 Taxon Name: PANTHERA TIGRIS Studbook Number: 1500
 =====

WILD

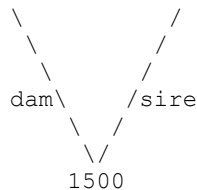

WILD
 Sex: Female
 Birth Date: ~ 2006
 Last Location: NAINITAL
 House Name:
 Tattoo:
 Tag/Band:

=====
 Taxon Name: PANTHERA TIGRIS Studbook Number: 1501
 =====

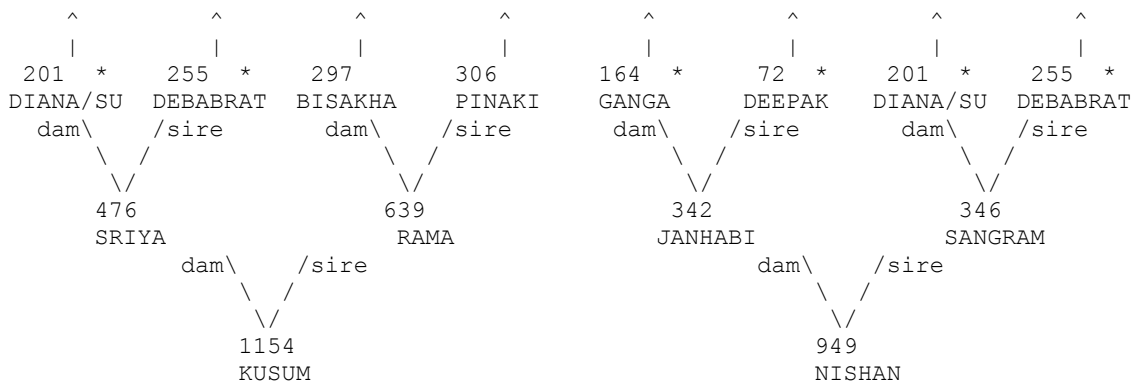

WILD
 Sex: Female
 Birth Date: 1 Mar 2010
 Last Location: NANDANKAN
 House Name:
 Tattoo:
 Tag/Band:

* Appear more than once...
 ^ Pedigree continues beyond top of page...

=====
 Taxon Name: PANTHERA TIGRIS Studbook Number: 1502
 =====

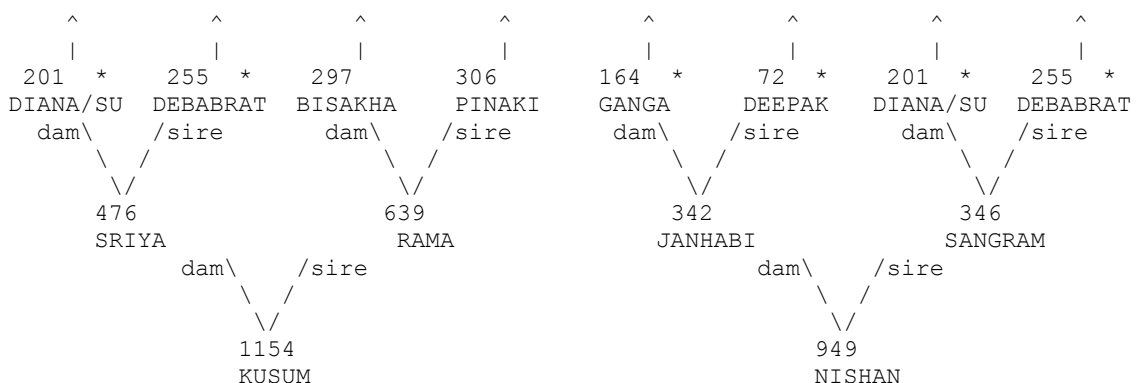

WILD
 Sex: Female
 Birth Date: 1 Mar 2010
 Last Location: NANDANKAN (dead)
 House Name:
 Tattoo:
 Tag/Band:

* Appear more than once...
 ^ Pedigree continues beyond top of page...

=====
 Taxon Name: PANTHERA TIGRIS Studbook Number: 1503
 =====

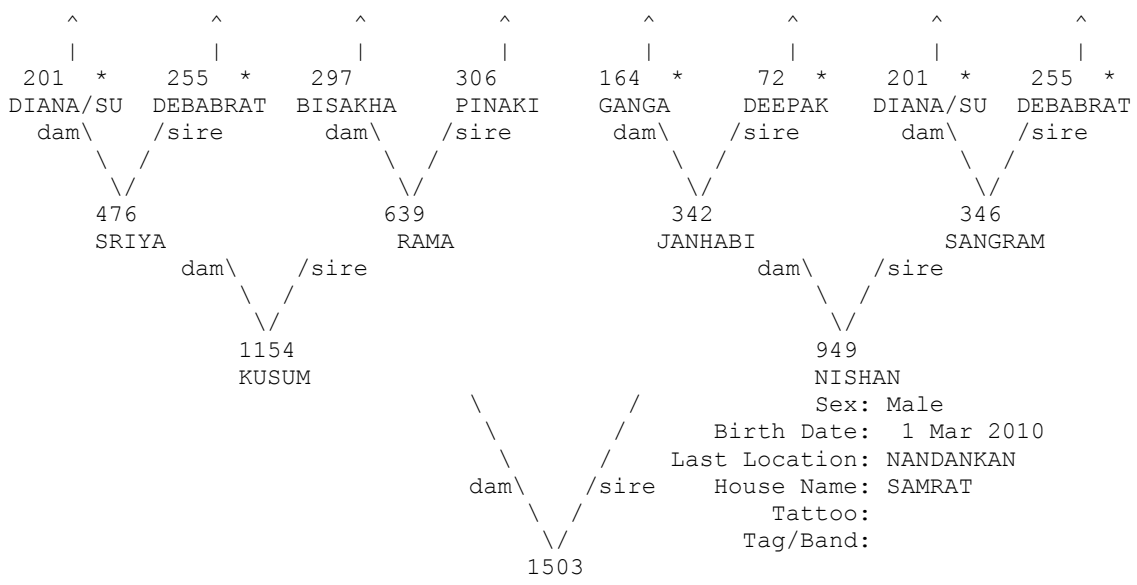

* Appear more than once...
 ^ Pedigree continues beyond top of page...

=====
 Taxon Name: PANTHERA TIGRIS Studbook Number: 1504
 =====

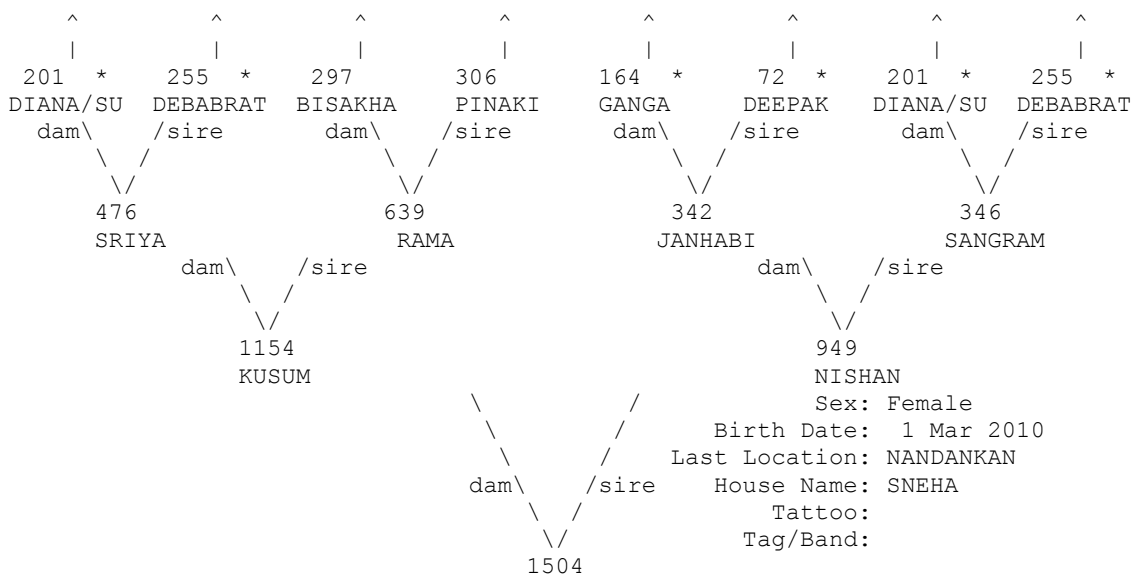

* Appear more than once...
 ^ Pedigree continues beyond top of page...

=====
 Taxon Name: PANTHERA TIGRIS Studbook Number: 1507
 =====

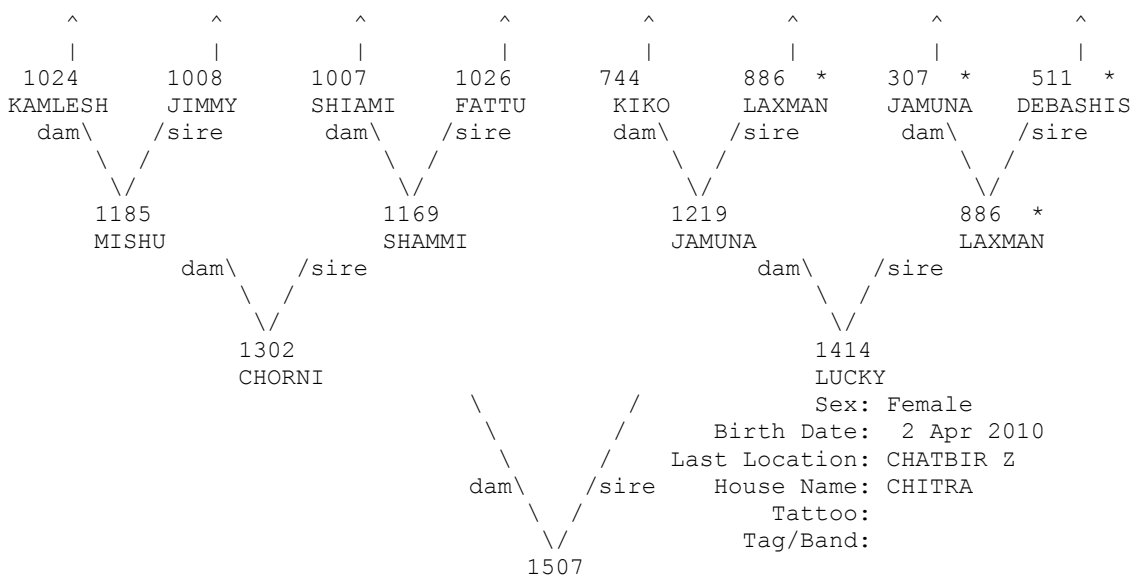

* Appear more than once...
 ^ Pedigree continues beyond top of page...

=====
 Taxon Name: PANTHERA TIGRIS Studbook Number: 1508
 =====

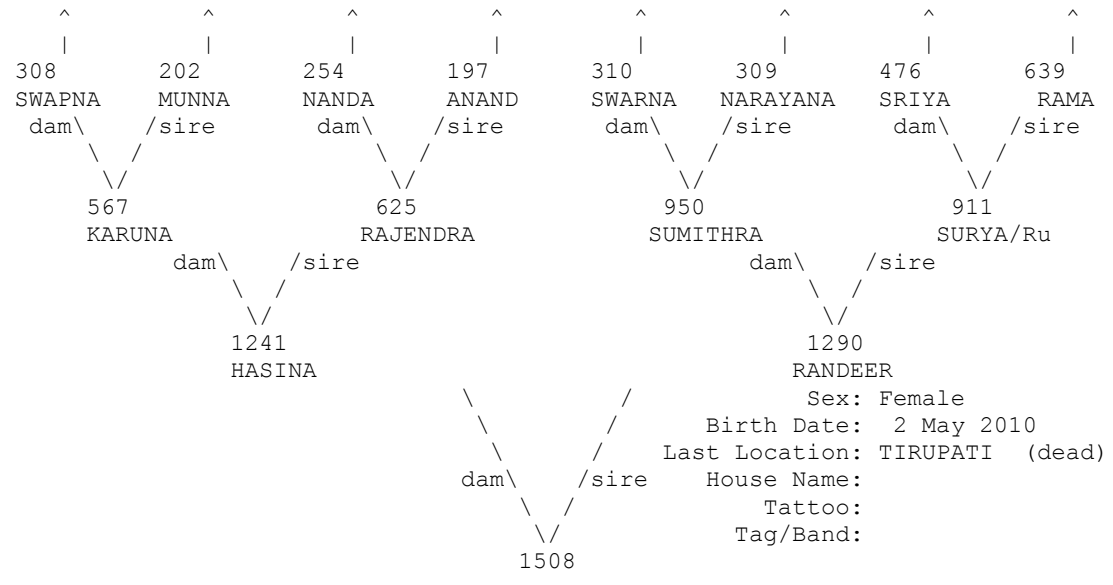

* Appear more than once...
 ^ Pedigree continues beyond top of page...

=====
 Taxon Name: PANTHERA TIGRIS Studbook Number: 1510
 =====

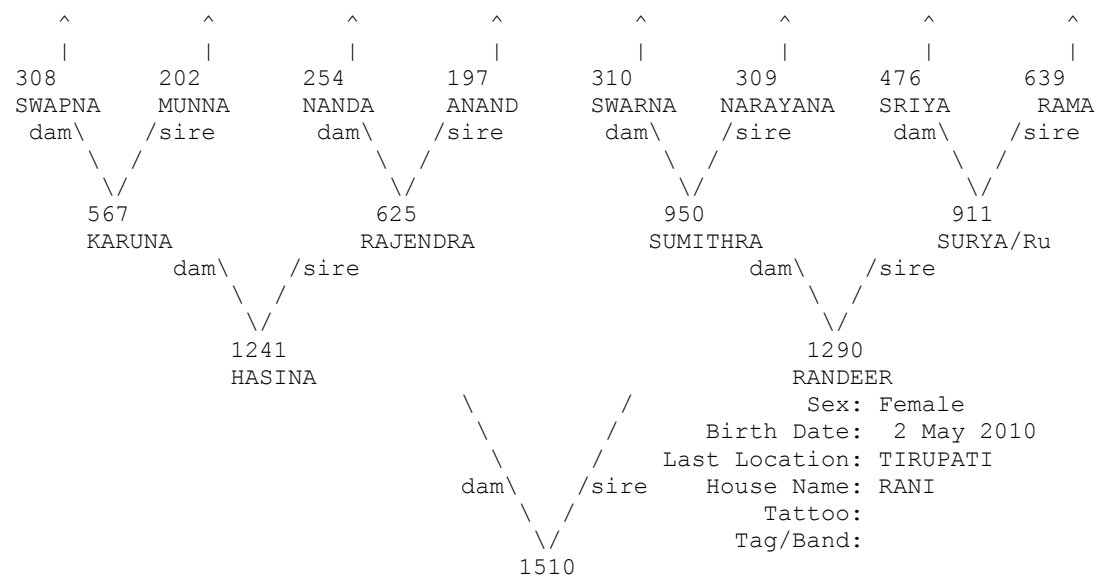

* Appear more than once...
 ^ Pedigree continues beyond top of page...

=====
 Taxon Name: PANTHERA TIGRIS Studbook Number: 1511
 =====

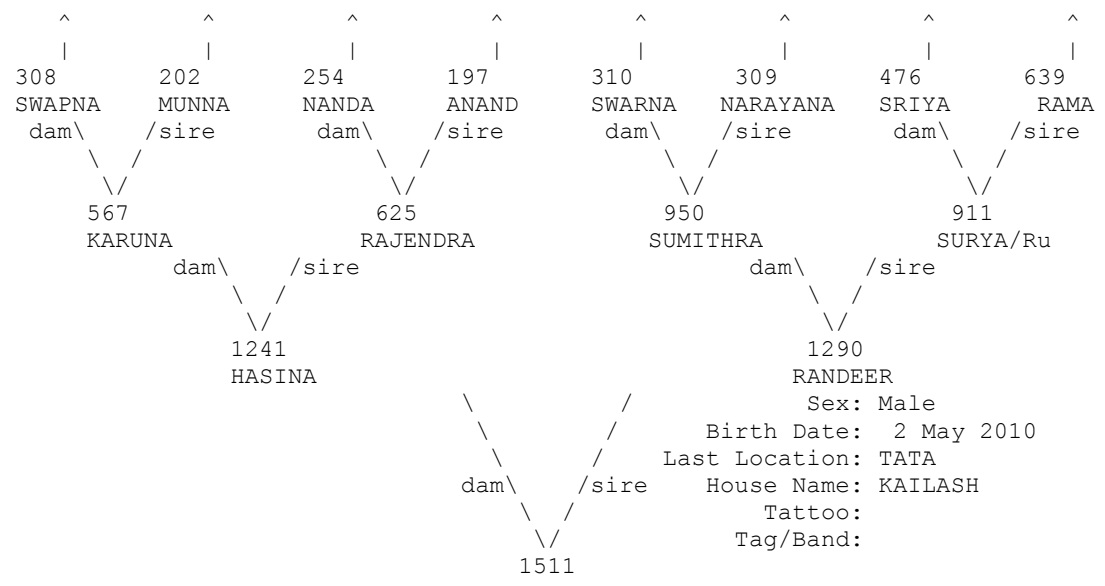

* Appear more than once...
 ^ Pedigree continues beyond top of page...

=====
 Taxon Name: PANTHERA TIGRIS Studbook Number: 1515
 =====

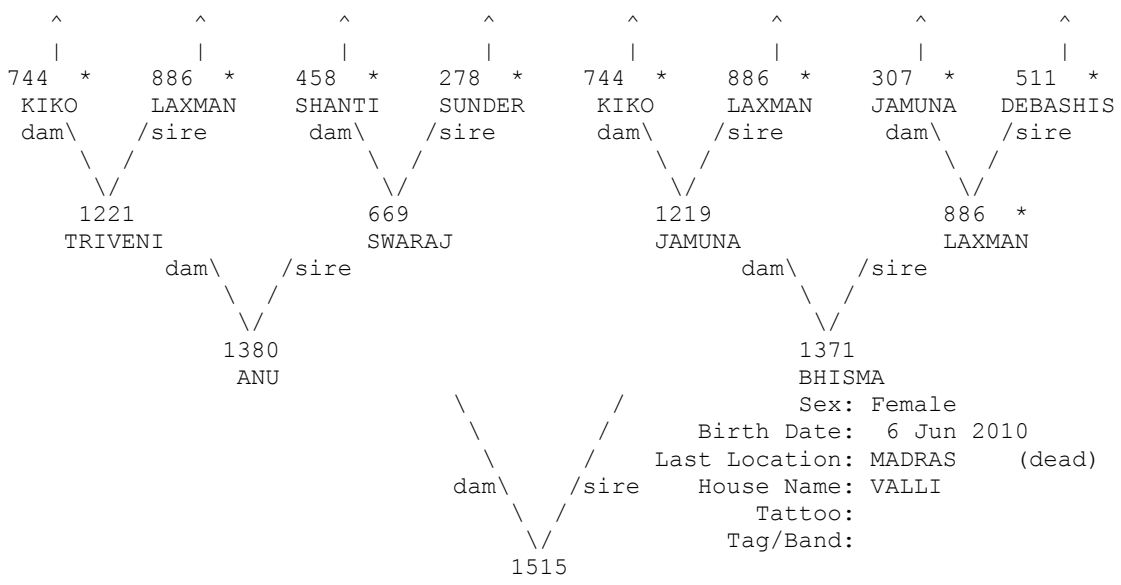

* Appear more than once...
 ^ Pedigree continues beyond top of page...

=====
 Taxon Name: PANTHERA TIGRIS Studbook Number: 1516
 =====

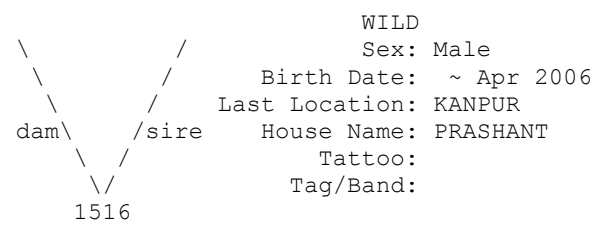

Sex: Male
 Birth Date: ~ Apr 2006
 Last Location: KANPUR
 House Name: PRASHANT
 Tattoo:
 Tag/Band:

=====
 Taxon Name: PANTHERA TIGRIS Studbook Number: 1517
 =====

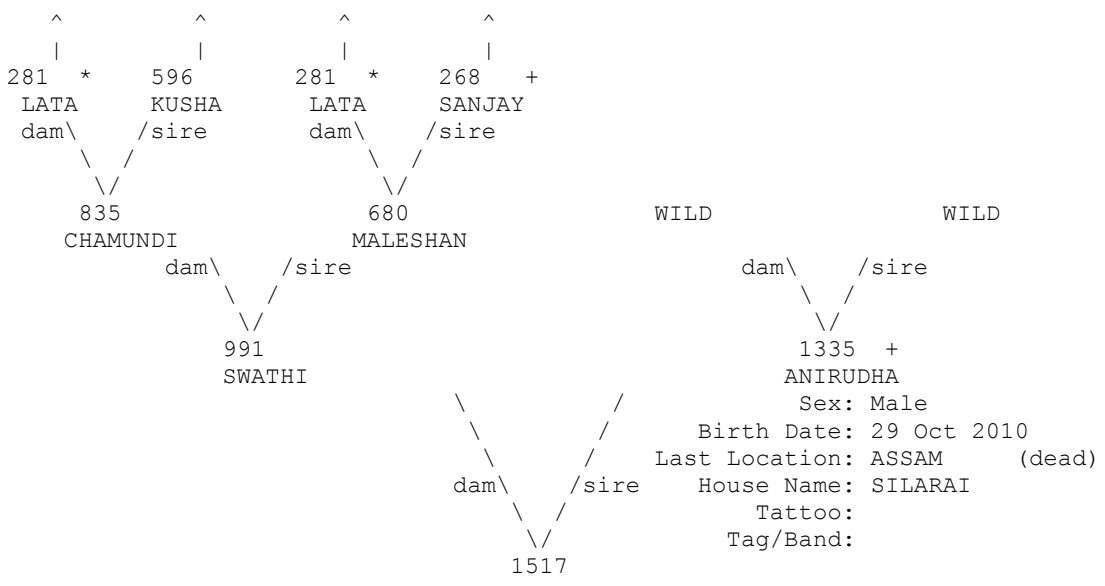

+ Wild-caught... * Appear more than once...
 ^ Pedigree continues beyond top of page...

=====
 Taxon Name: PANTHERA TIGRIS Studbook Number: 1518
 =====

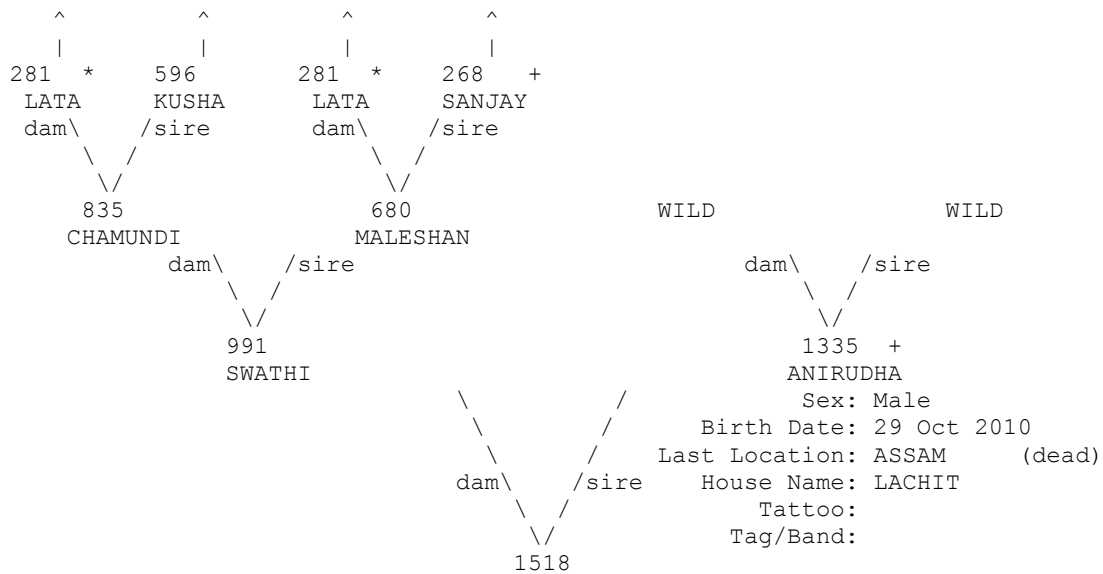

+ Wild-caught... * Appear more than once...
 ^ Pedigree continues beyond top of page...

=====
 Taxon Name: PANTHERA TIGRIS Studbook Number: 1519
 =====

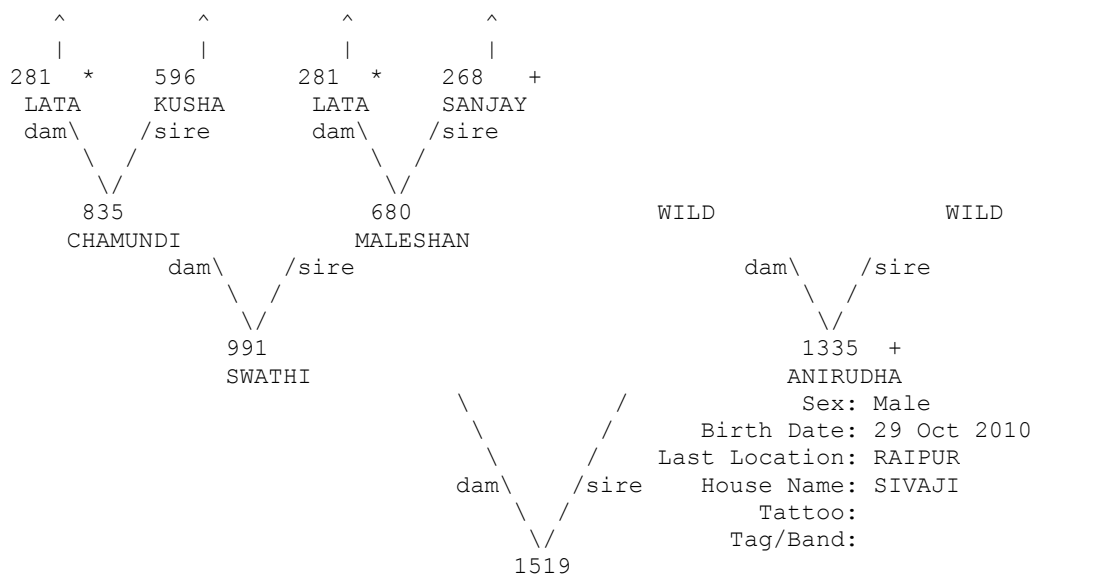

+ Wild-caught... * Appear more than once...
 ^ Pedigree continues beyond top of page...

=====
 Taxon Name: PANTHERA TIGRIS Studbook Number: 1520
 =====

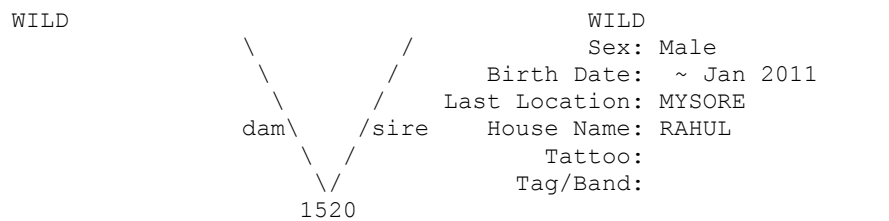

=====

Taxon Name: PANTHERA TIGRIS Studbook Number: 1521

=====

UNK

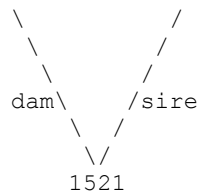

UNK
 Sex: Male
 Birth Date: 25 Feb 2011
 Last Location: BANNERGHA
 House Name: RAJAT
 Tattoo:
 Tag/Band:

=====

Taxon Name: PANTHERA TIGRIS Studbook Number: 1522

=====

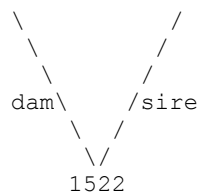
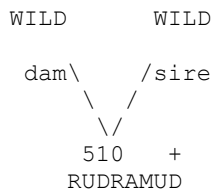
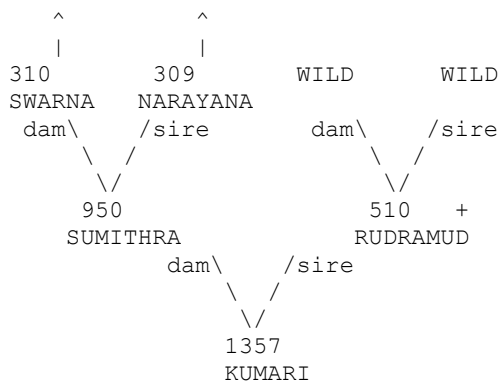

UNK
 Sex: Female
 Birth Date: 16 Mar 2011
 Last Location: VISAKAPAT
 House Name: SAVITRI
 Tattoo:
 Tag/Band:

+ Wild-caught... * Appear more than once...
 ^ Pedigree continues beyond top of page...

=====

Taxon Name: PANTHERA TIGRIS Studbook Number: 1523

=====

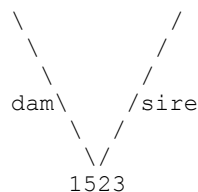
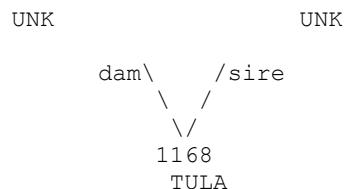
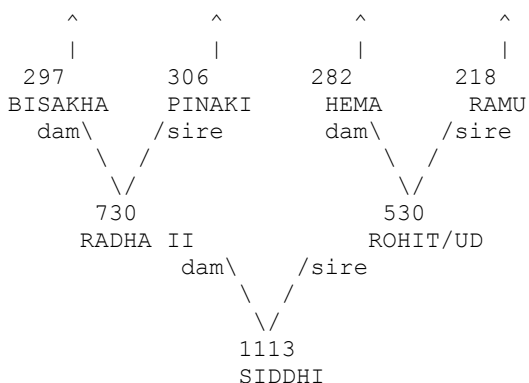

UNK
 Sex: Female
 Birth Date: 4 Apr 2011
 Last Location: RAJKOT
 House Name: DHARA
 Tattoo:
 Tag/Band:

* Appear more than once...
 ^ Pedigree continues beyond top of page...

=====
 Taxon Name: PANTHERA TIGRIS Studbook Number: 1527
 =====

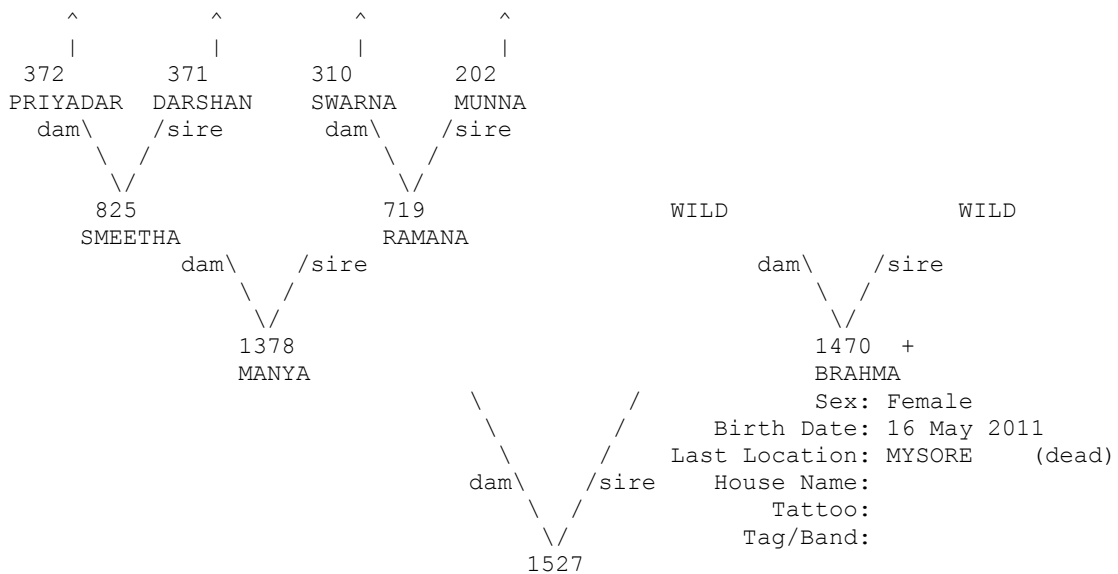

+ Wild-caught... * Appear more than once...
 ^ Pedigree continues beyond top of page...

=====
 Taxon Name: PANTHERA TIGRIS Studbook Number: 1528
 =====

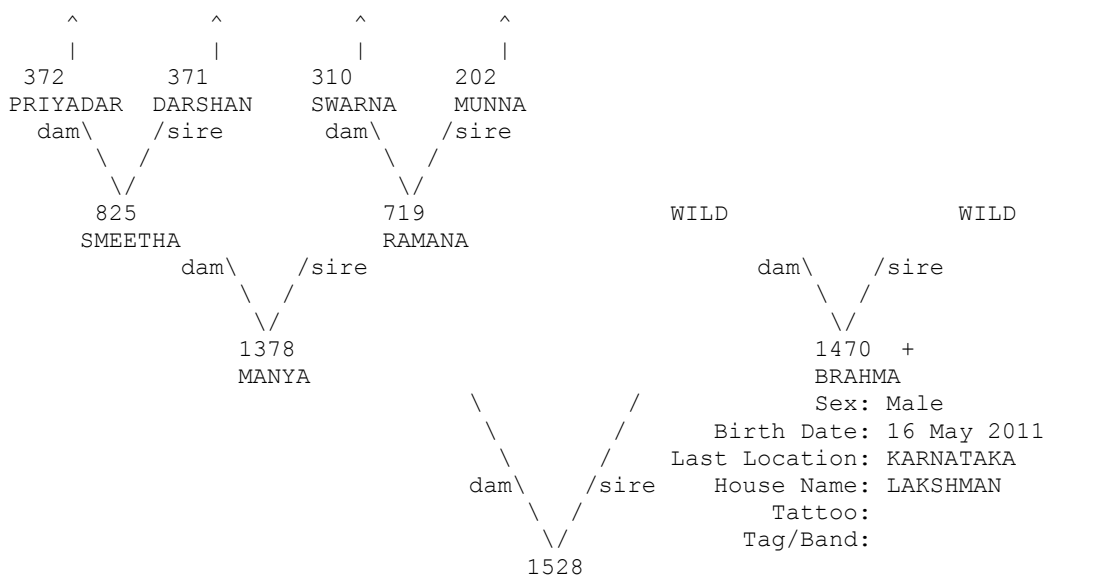

+ Wild-caught... * Appear more than once...
 ^ Pedigree continues beyond top of page...

=====
 Taxon Name: PANTHERA TIGRIS Studbook Number: 1529
 =====

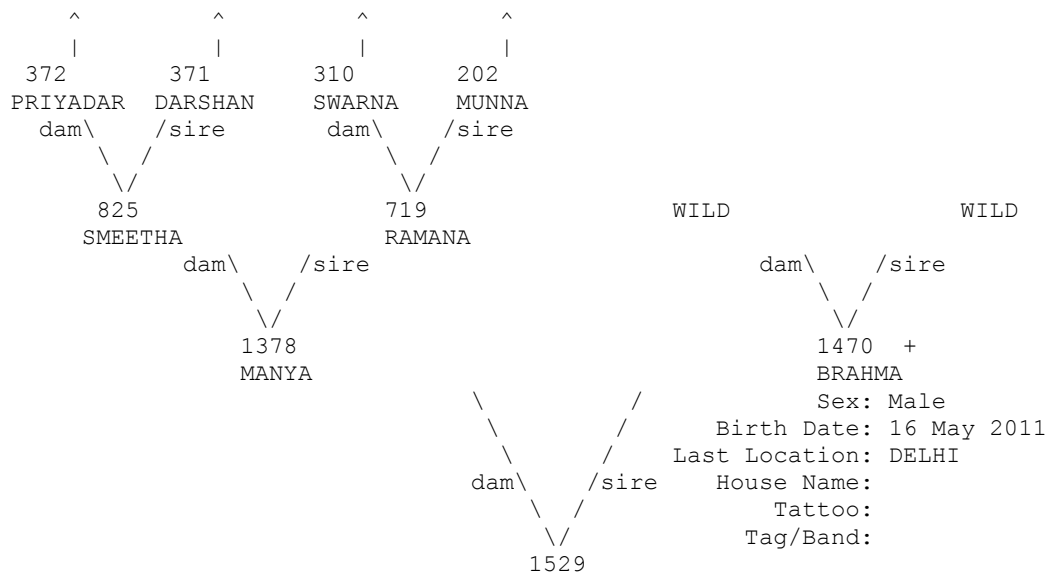

+ Wild-caught... * Appear more than once...
 ^ Pedigree continues beyond top of page...

=====
 Taxon Name: PANTHERA TIGRIS Studbook Number: 1530
 =====

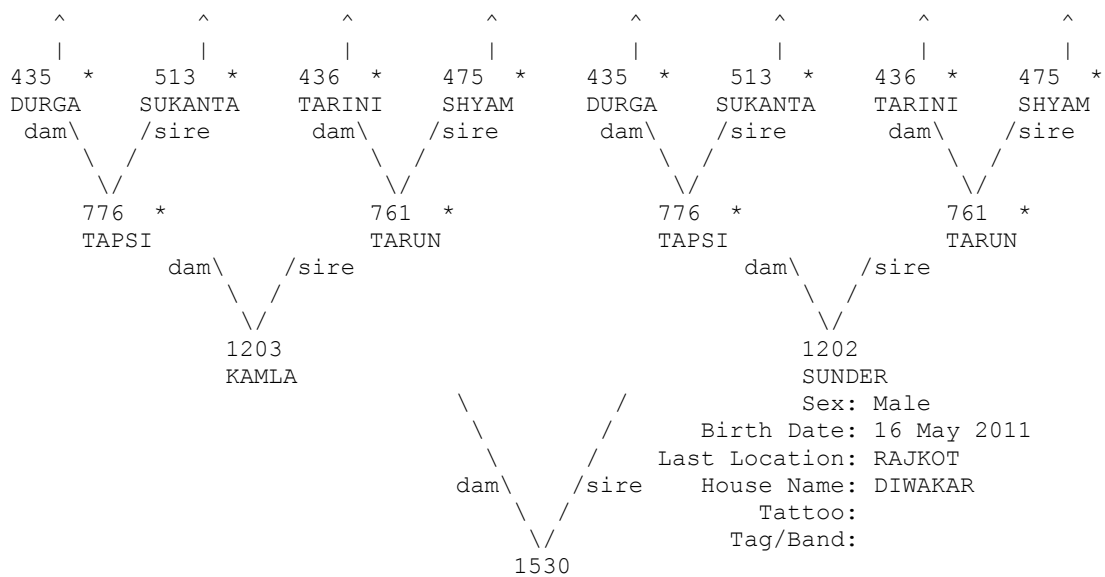

* Appear more than once...
 ^ Pedigree continues beyond top of page...

=====
 Taxon Name: PANTHERA TIGRIS Studbook Number: 1531
 =====

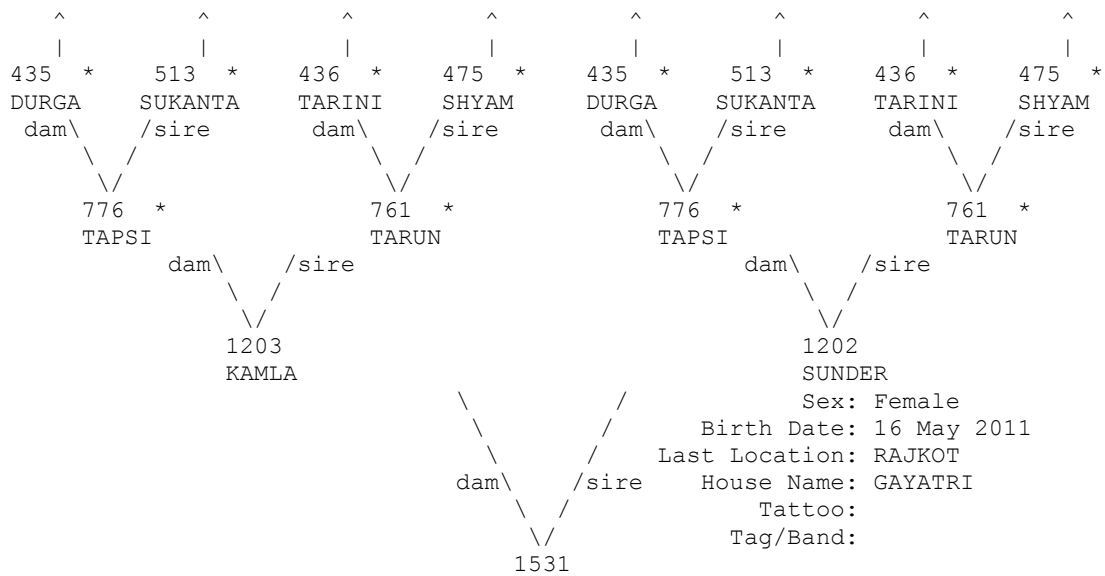

* Appear more than once...
 ^ Pedigree continues beyond top of page...

=====
 Taxon Name: PANTHERA TIGRIS Studbook Number: 1532
 =====

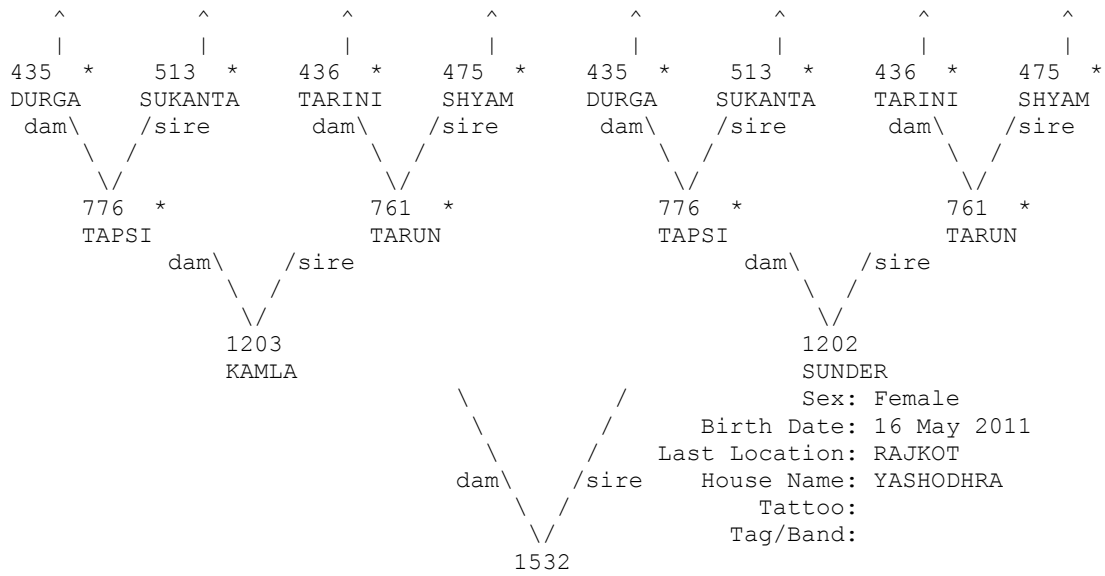

* Appear more than once...
 ^ Pedigree continues beyond top of page...

=====
Taxon Name: PANTHERA TIGRIS Studbook Number: 1533
=====

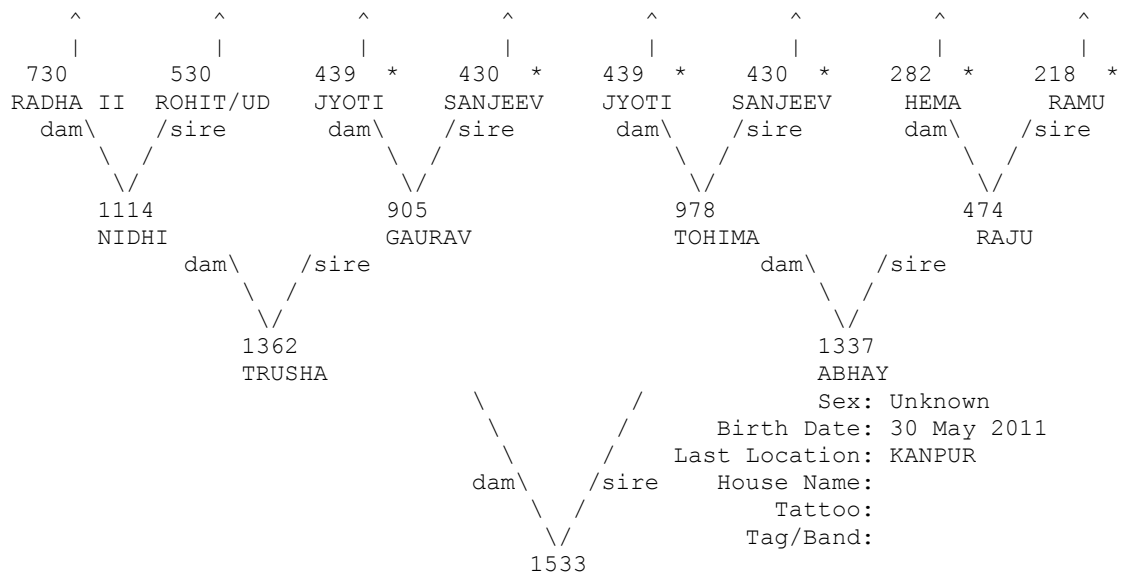

* Appear more than once...
^ Pedigree continues beyond top of page...

=====
Taxon Name: PANTHERA TIGRIS Studbook Number: 1534
=====

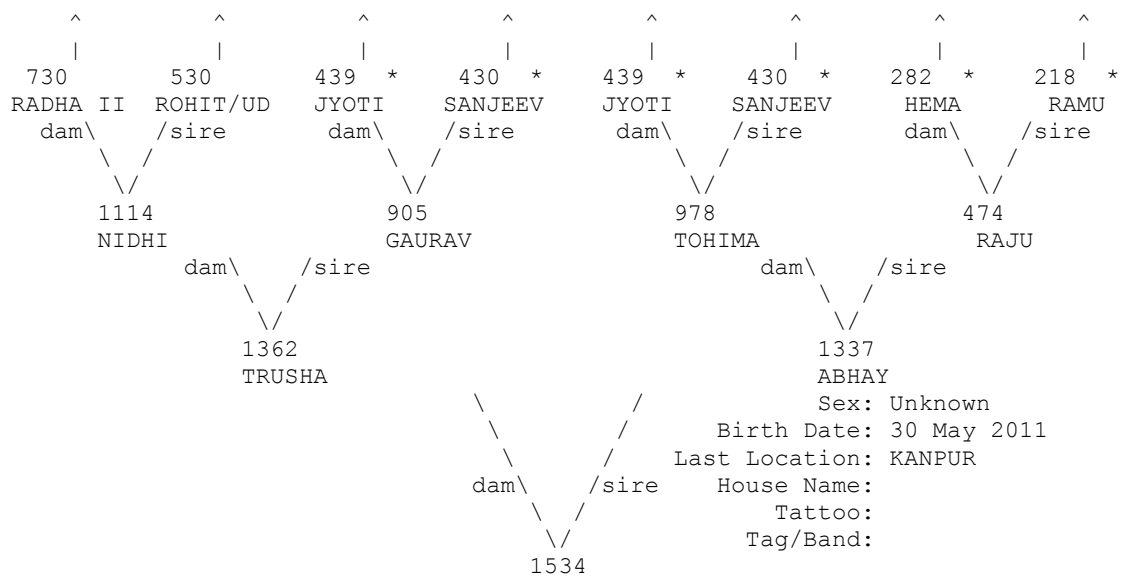

* Appear more than once...
^ Pedigree continues beyond top of page...

=====
 Taxon Name: PANTHERA TIGRIS Studbook Number: 1535
 =====

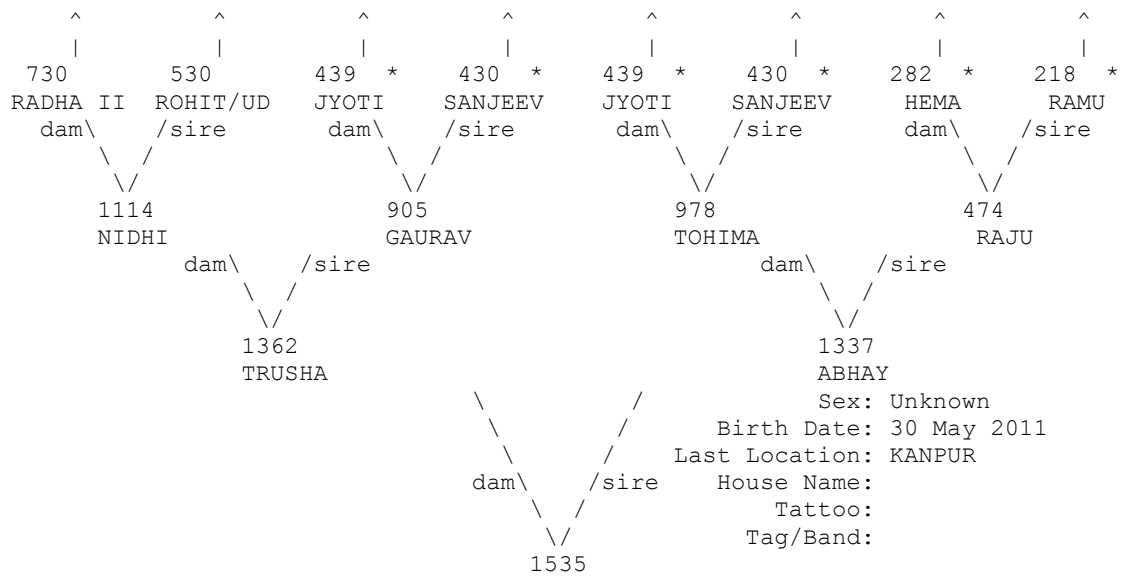

* Appear more than once...
 ^ Pedigree continues beyond top of page...

=====
 Taxon Name: PANTHERA TIGRIS Studbook Number: 1536
 =====

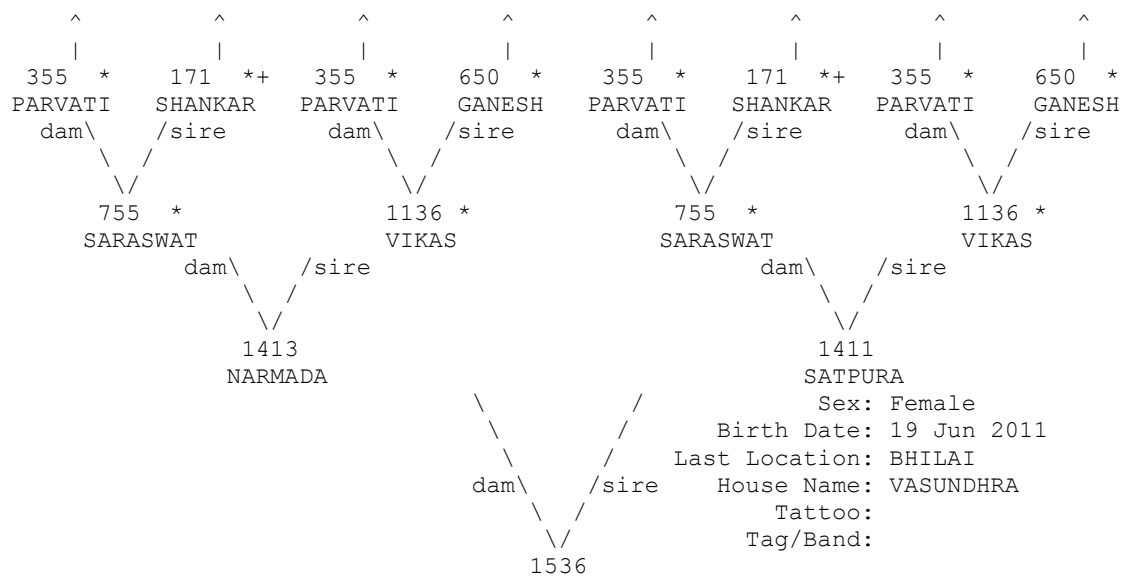

+ Wild-caught... * Appear more than once...
 ^ Pedigree continues beyond top of page...

=====
 Taxon Name: PANTHERA TIGRIS Studbook Number: 1537
 =====

WILD

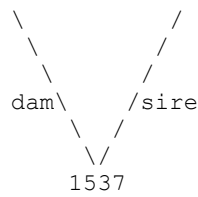

WILD
 Sex: Male
 Birth Date: ~ 2009
 Last Location: DELHI
 House Name: B2
 Tattoo:
 Tag/Band:

=====
 Taxon Name: PANTHERA TIGRIS Studbook Number: 1538
 =====

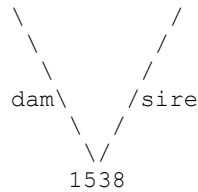
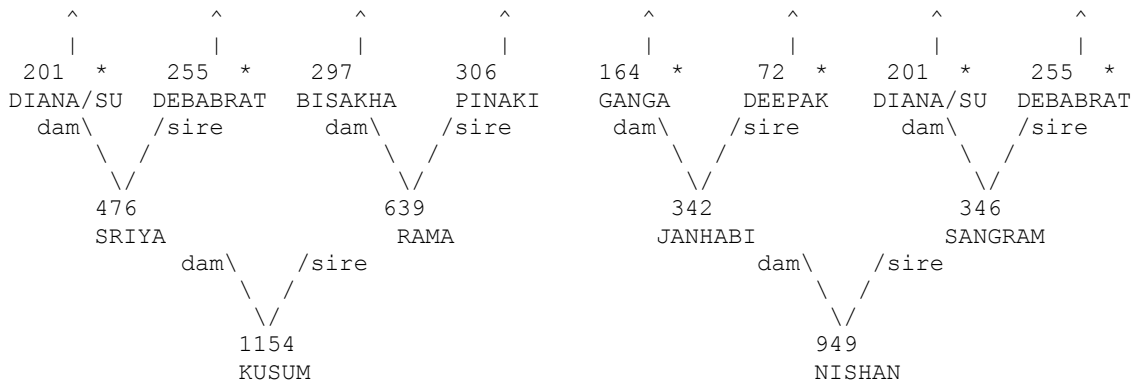

Sex: Female
 Birth Date: 13 Jul 2011
 Last Location: NANDANKAN
 House Name: RAGINI
 Tattoo:
 Tag/Band:

* Appear more than once...
 ^ Pedigree continues beyond top of page...

=====
 Taxon Name: PANTHERA TIGRIS Studbook Number: 1539
 =====

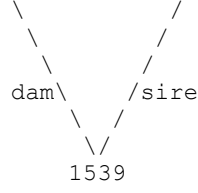
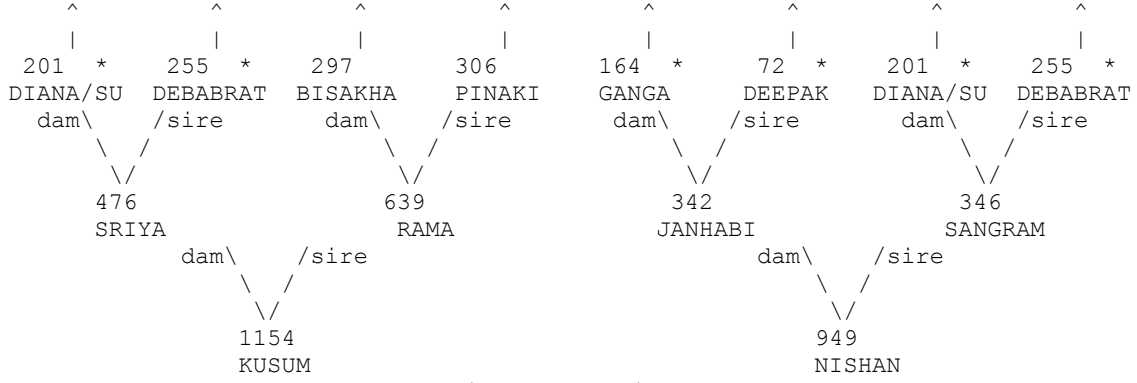

Sex: Female
 Birth Date: 13 Jul 2011
 Last Location: NANDANKAN
 House Name: BIJAYA
 Tattoo:
 Tag/Band:

* Appear more than once...
 ^ Pedigree continues beyond top of page...

=====
 Taxon Name: PANTHERA TIGRIS Studbook Number: 1540
 =====

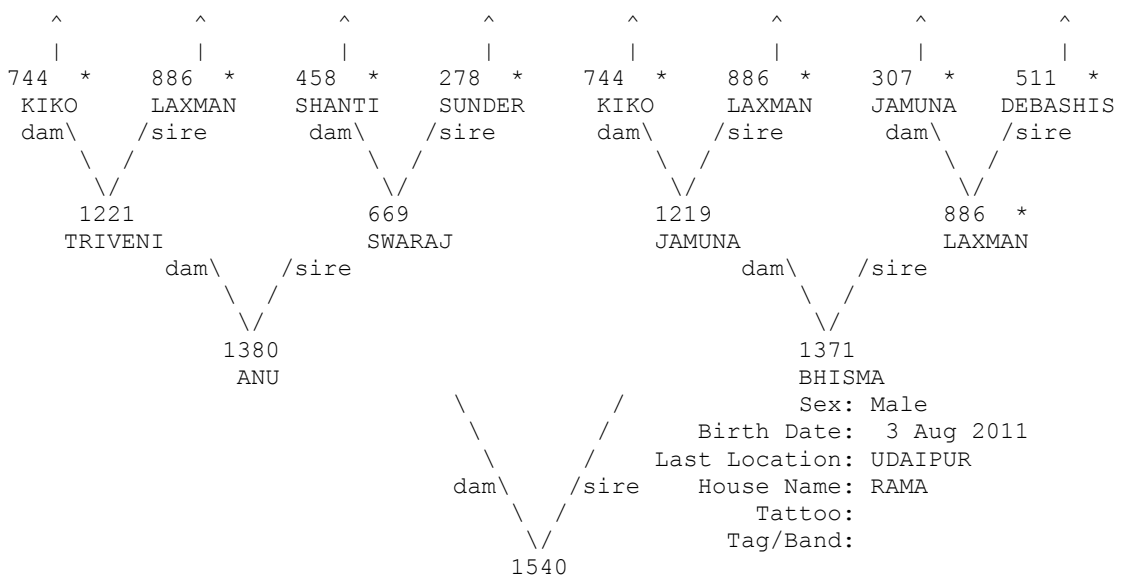

* Appear more than once...
 ^ Pedigree continues beyond top of page...

=====
 Taxon Name: PANTHERA TIGRIS Studbook Number: 1541
 =====

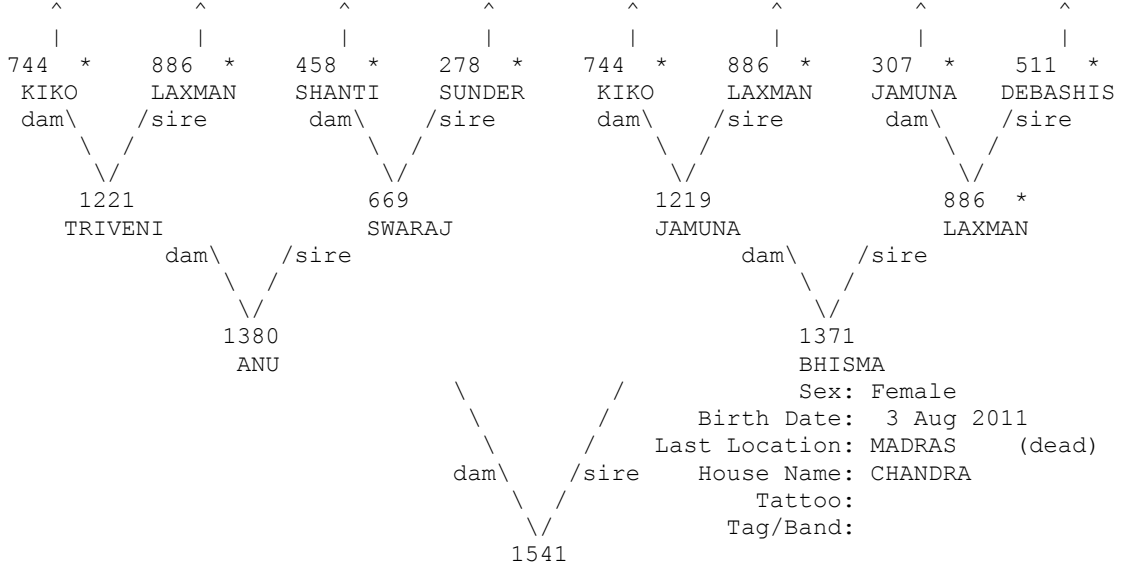

* Appear more than once...
 ^ Pedigree continues beyond top of page...

=====
 Taxon Name: PANTHERA TIGRIS Studbook Number: 1543
 =====

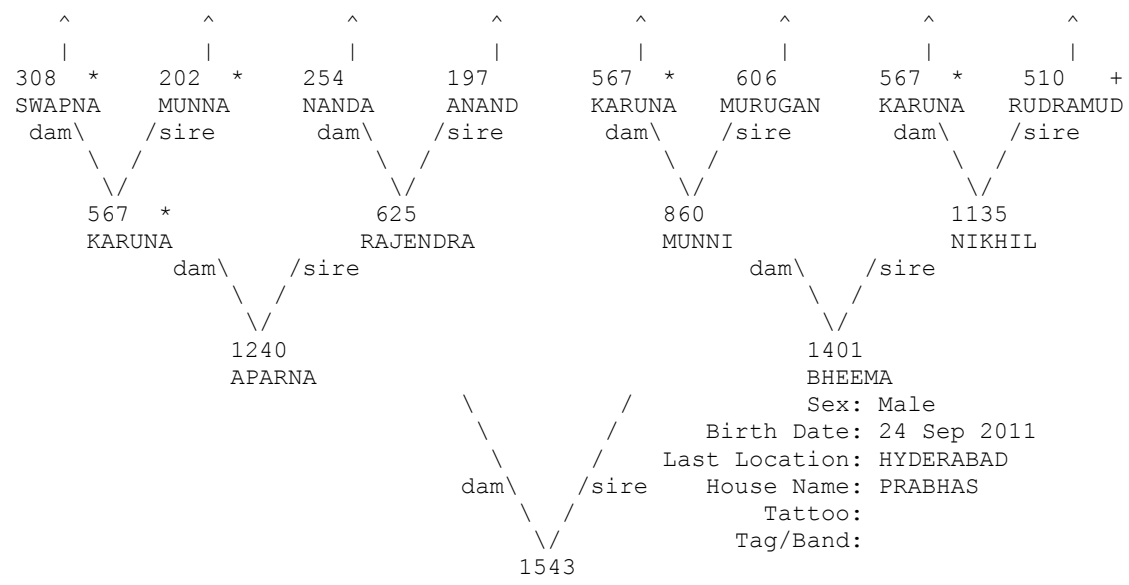

+ Wild-caught... * Appear more than once...
 ^ Pedigree continues beyond top of page...

=====
 Taxon Name: PANTHERA TIGRIS Studbook Number: 1544
 =====

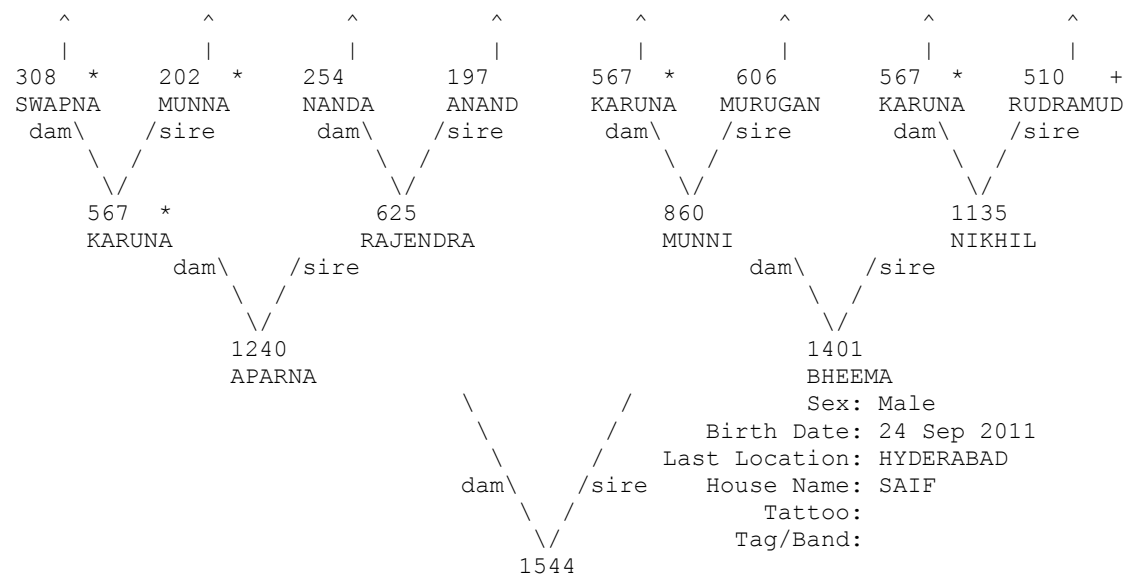

+ Wild-caught... * Appear more than once...
 ^ Pedigree continues beyond top of page...

=====
 Taxon Name: PANTHERA TIGRIS Studbook Number: 1545
 =====

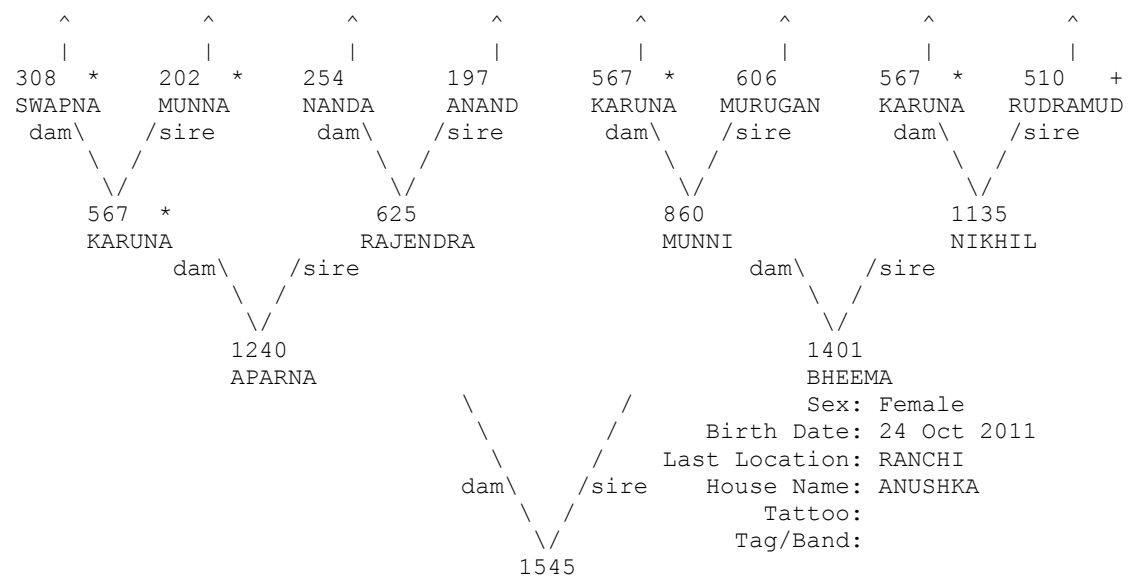

+ Wild-caught... * Appear more than once...
 ^ Pedigree continues beyond top of page...

=====
 Taxon Name: PANTHERA TIGRIS Studbook Number: 1546
 =====

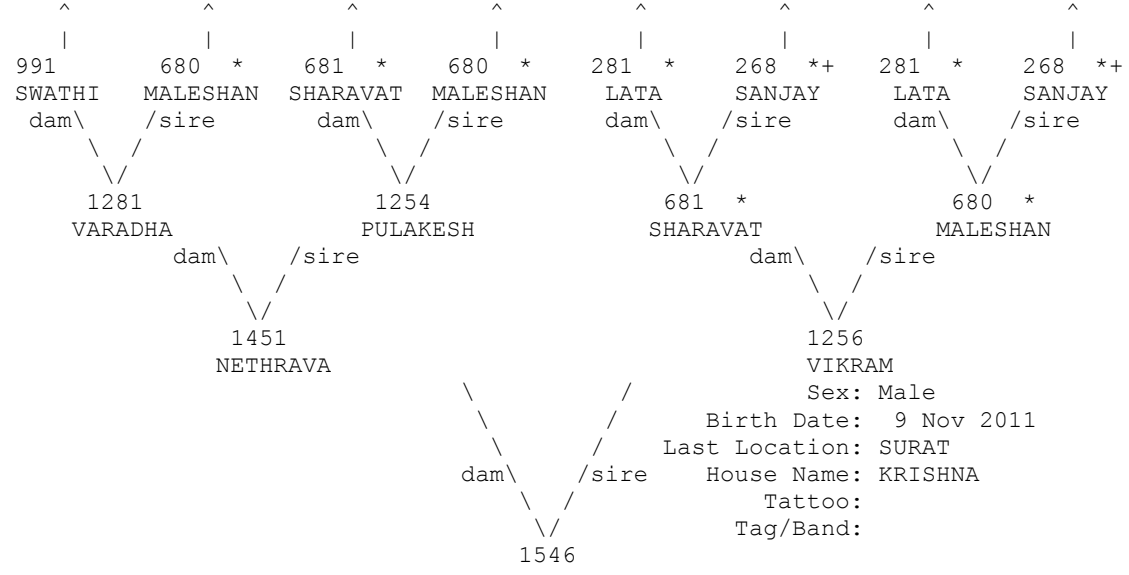

+ Wild-caught... * Appear more than once...
 ^ Pedigree continues beyond top of page...

=====
 Taxon Name: PANTHERA TIGRIS Studbook Number: 1547
 =====

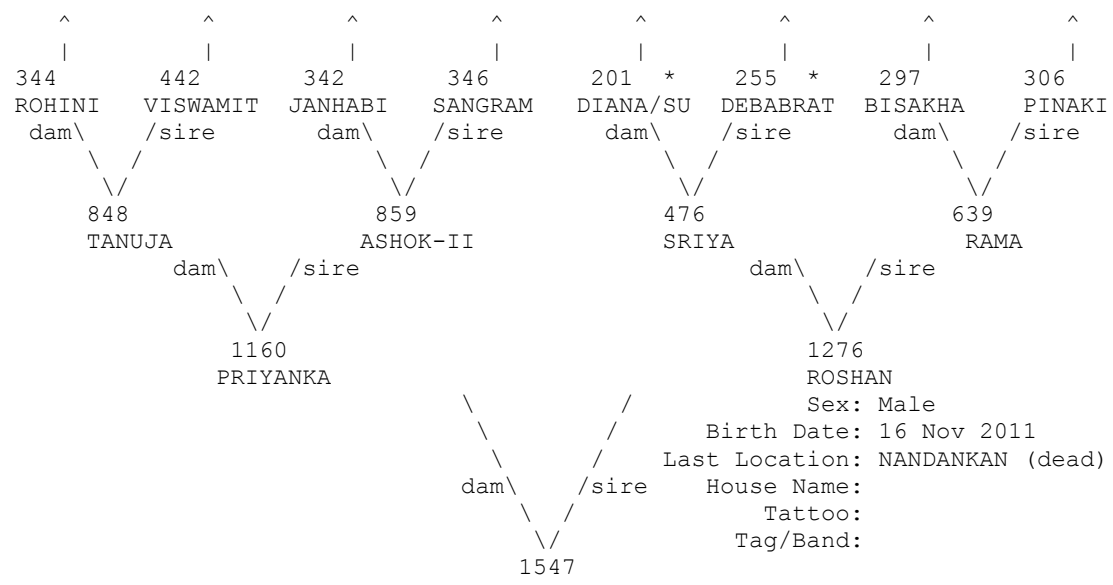

* Appear more than once...
 ^ Pedigree continues beyond top of page...

=====
 Taxon Name: PANTHERA TIGRIS Studbook Number: 1548
 =====

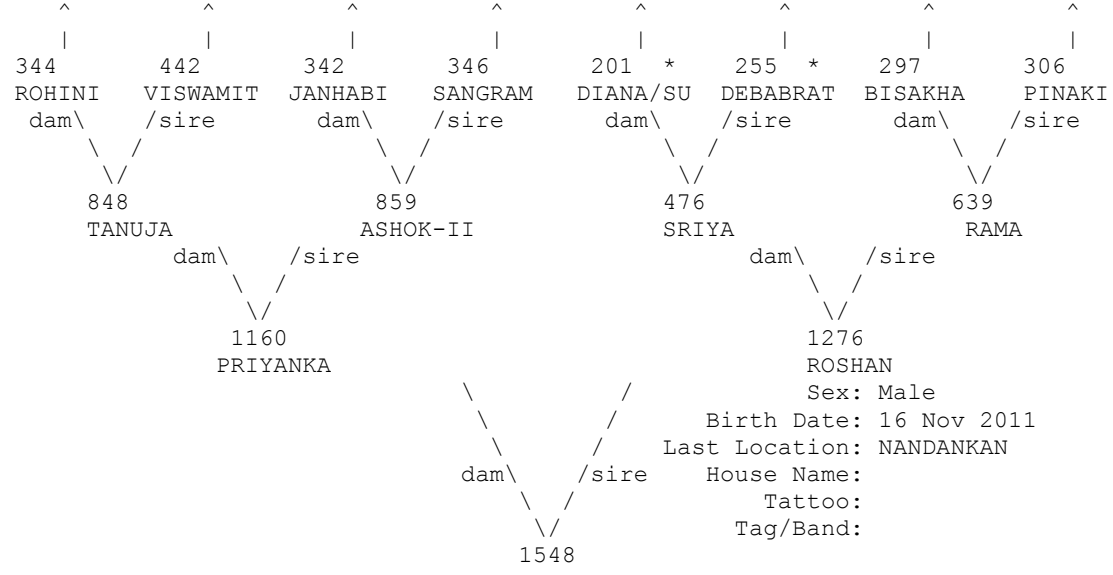

* Appear more than once...

^ Pedigree continues beyond top of page...

=====
Taxon Name: PANTHERA TIGRIS Studbook Number: 1549
=====

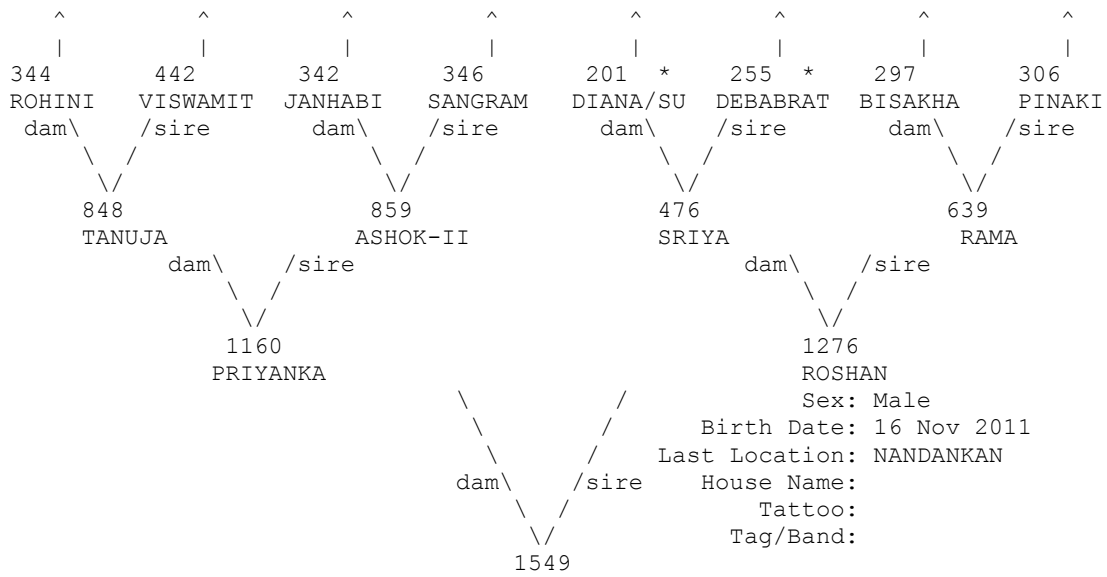

* Appear more than once...

^ Pedigree continues beyond top of page...

=====
Taxon Name: PANTHERA TIGRIS Studbook Number: 1550
=====

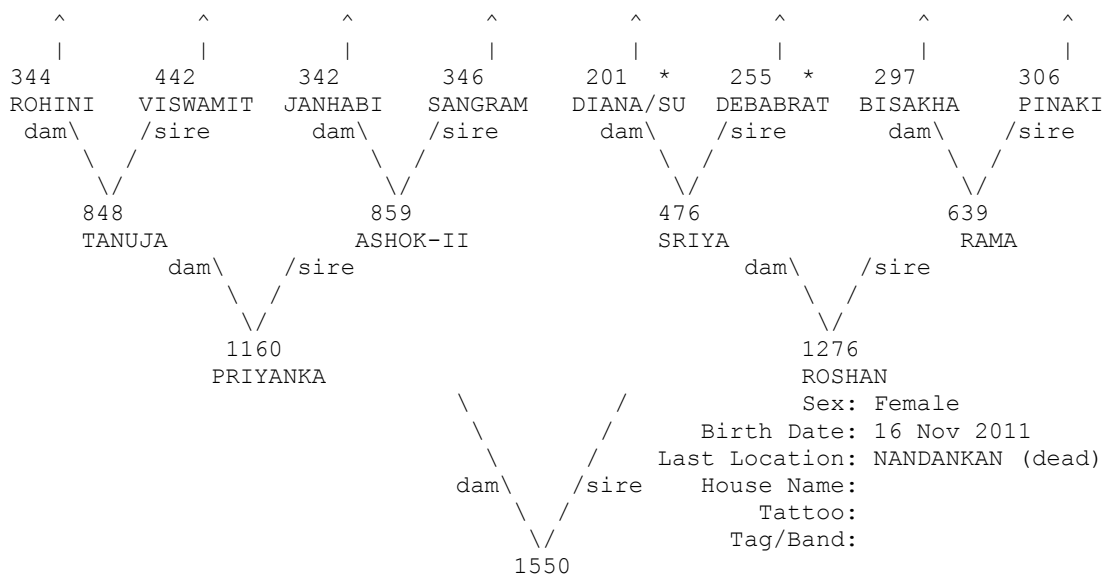

* Appear more than once...

^ Pedigree continues beyond top of page...

=====
 Taxon Name: PANTHERA TIGRIS Studbook Number: 1551
 =====

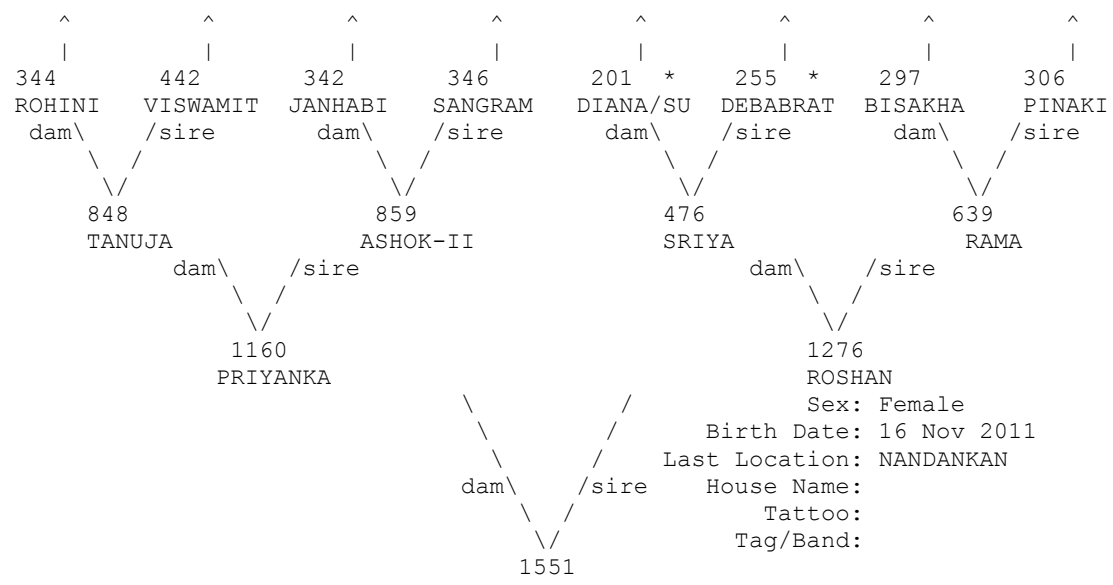

* Appear more than once...
 ^ Pedigree continues beyond top of page...

=====
 Taxon Name: PANTHERA TIGRIS Studbook Number: 1552
 =====

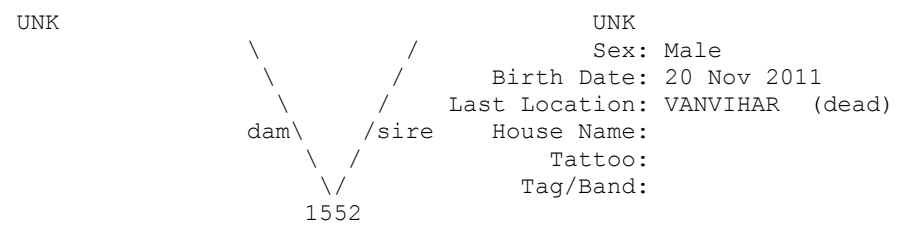

=====
 Taxon Name: PANTHERA TIGRIS Studbook Number: 1553
 =====

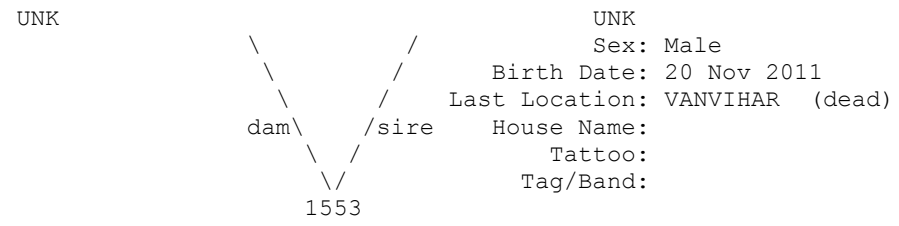

=====
 Taxon Name: PANTHERA TIGRIS Studbook Number: 1554
 =====

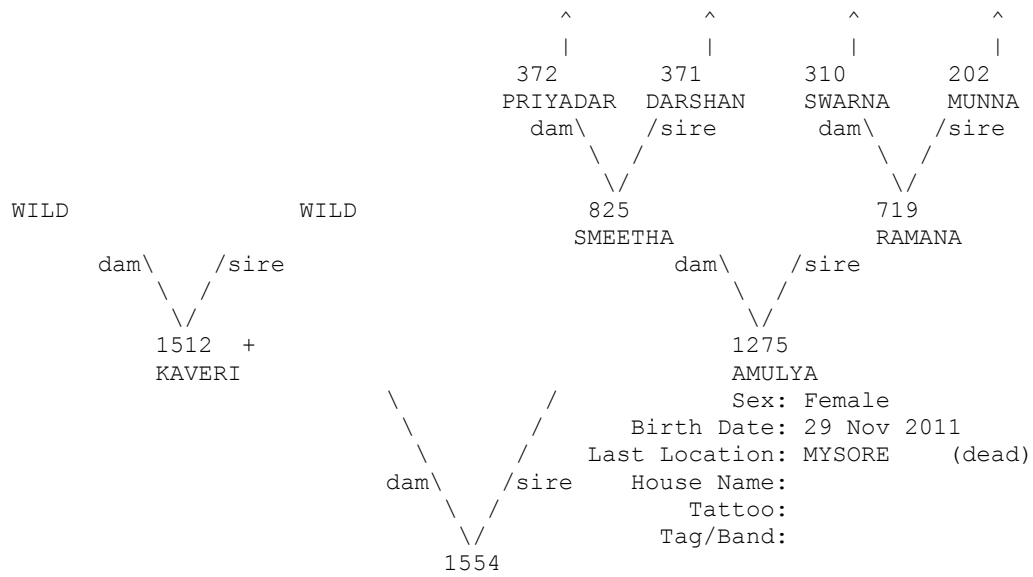

+ Wild-caught... * Appear more than once...
 ^ Pedigree continues beyond top of page...

=====
 Taxon Name: PANTHERA TIGRIS Studbook Number: 1555
 =====

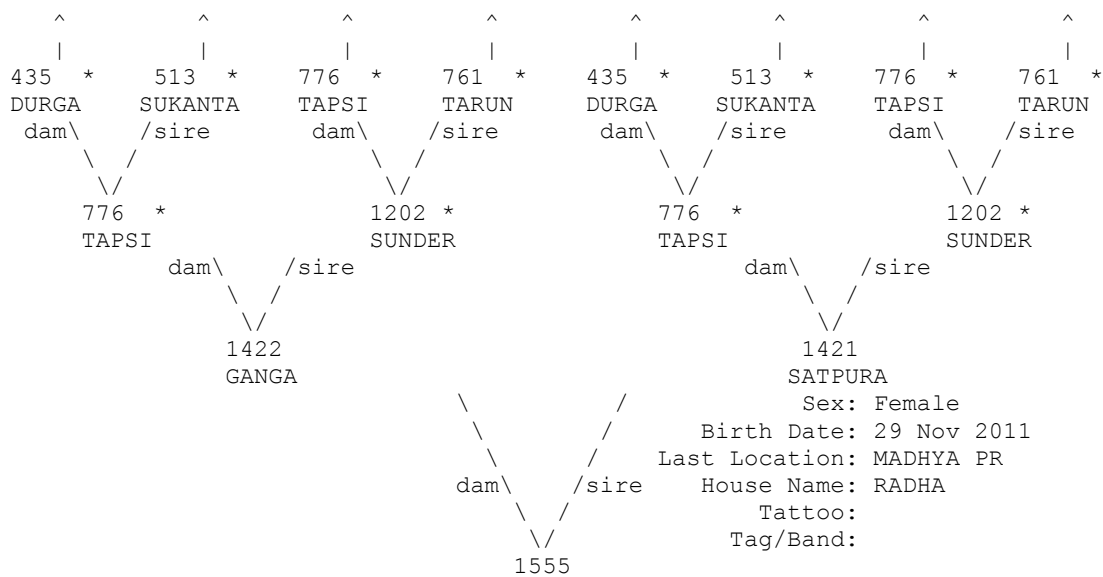

* Appear more than once...
 ^ Pedigree continues beyond top of page...

=====
 Taxon Name: PANTHERA TIGRIS Studbook Number: 1560
 =====

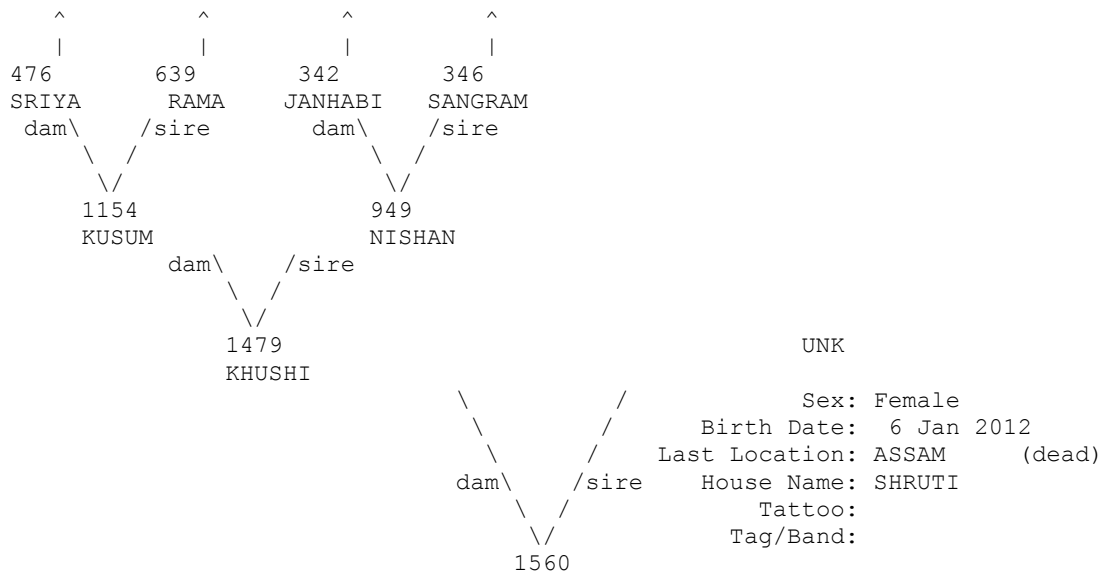

* Appear more than once...
 ^ Pedigree continues beyond top of page...

=====
 Taxon Name: PANTHERA TIGRIS Studbook Number: 1561
 =====

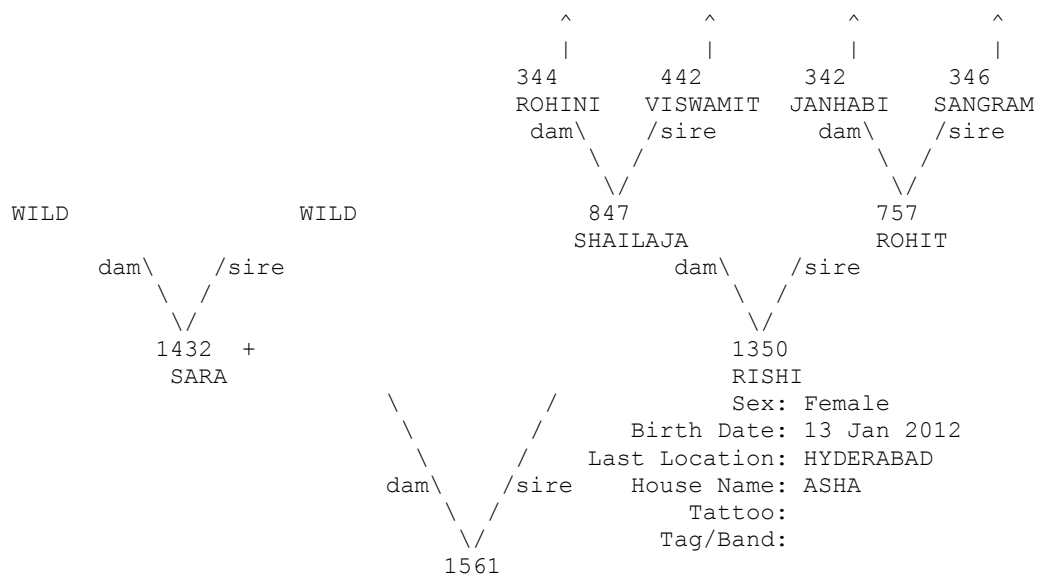

+ Wild-caught... * Appear more than once...
 ^ Pedigree continues beyond top of page...

=====
 Taxon Name: PANTHERA TIGRIS Studbook Number: 1562
 =====

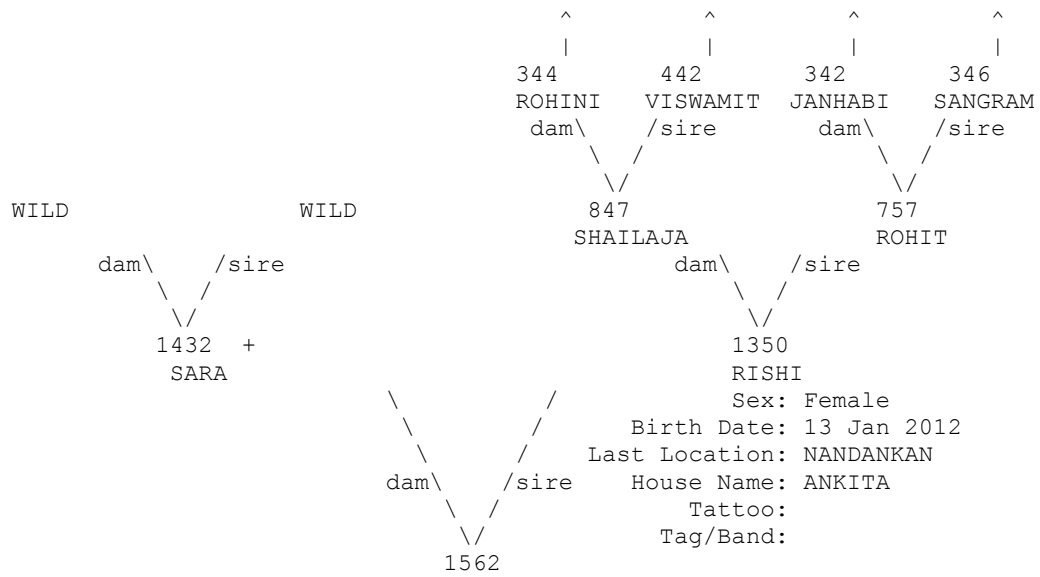

+ Wild-caught... * Appear more than once...
 ^ Pedigree continues beyond top of page...

=====
 Taxon Name: PANTHERA TIGRIS Studbook Number: 1563
 =====

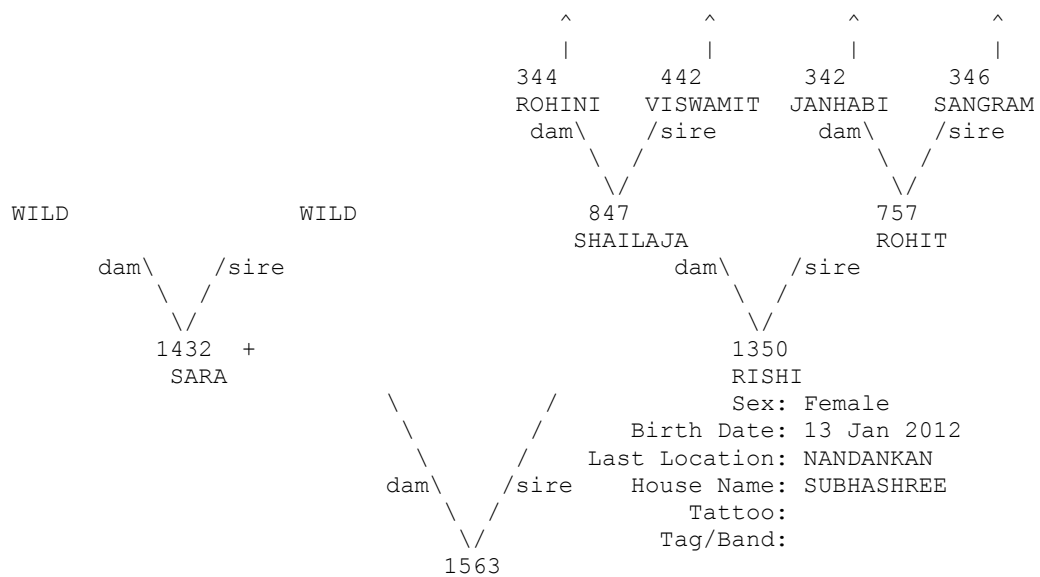

+ Wild-caught... * Appear more than once...
 ^ Pedigree continues beyond top of page...

=====
 Taxon Name: PANTHERA TIGRIS Studbook Number: 1564
 =====

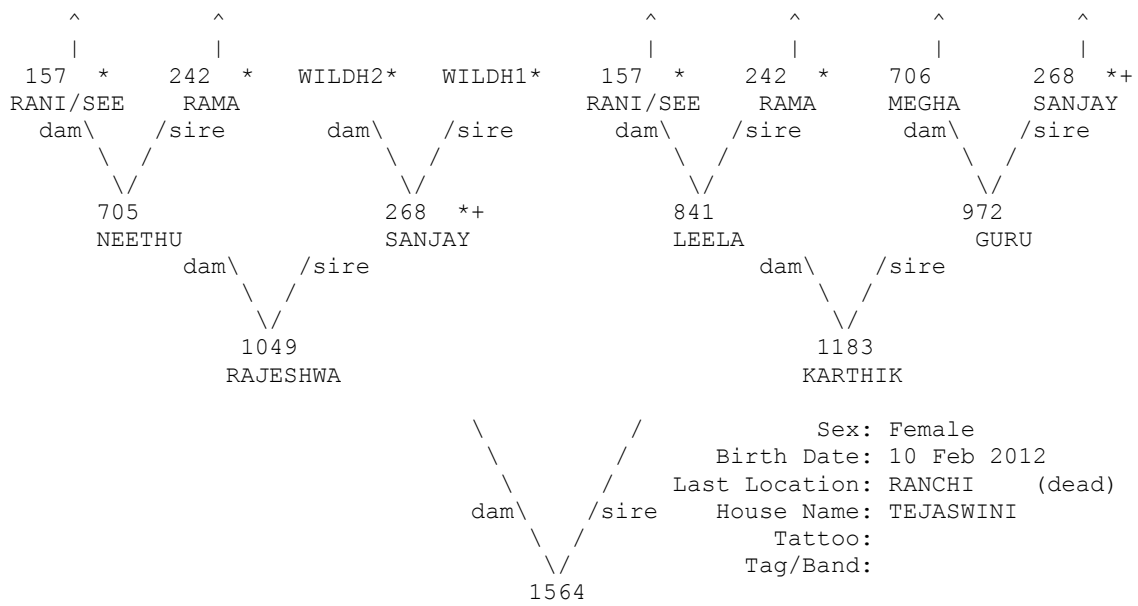

+ Wild-caught... * Appear more than once...
 ^ Pedigree continues beyond top of page...

=====
 Taxon Name: PANTHERA TIGRIS Studbook Number: 1565
 =====

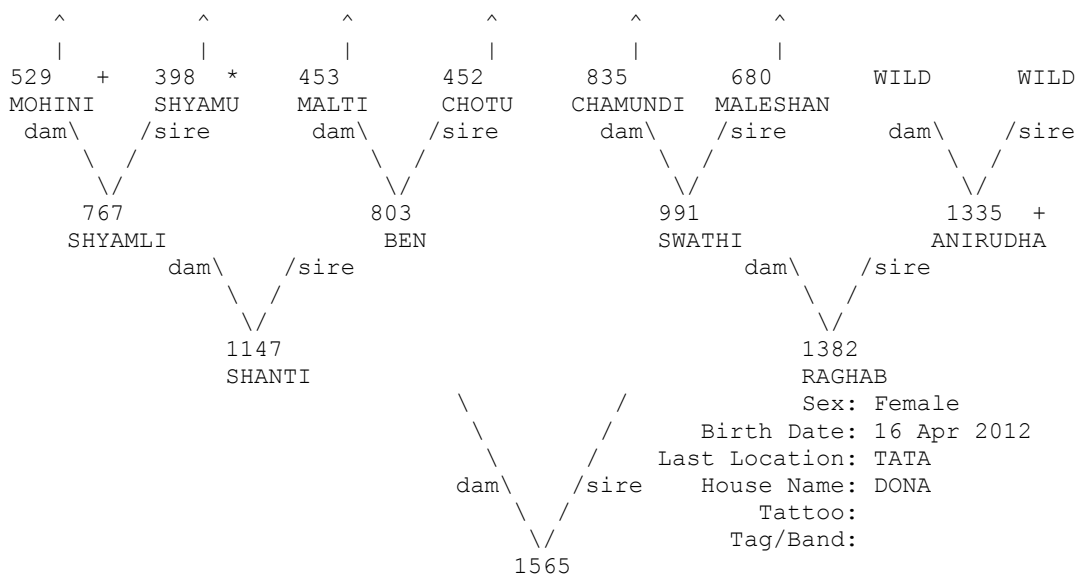

+ Wild-caught... * Appear more than once...
 ^ Pedigree continues beyond top of page...

=====
 Taxon Name: PANTHERA TIGRIS Studbook Number: 1566
 =====

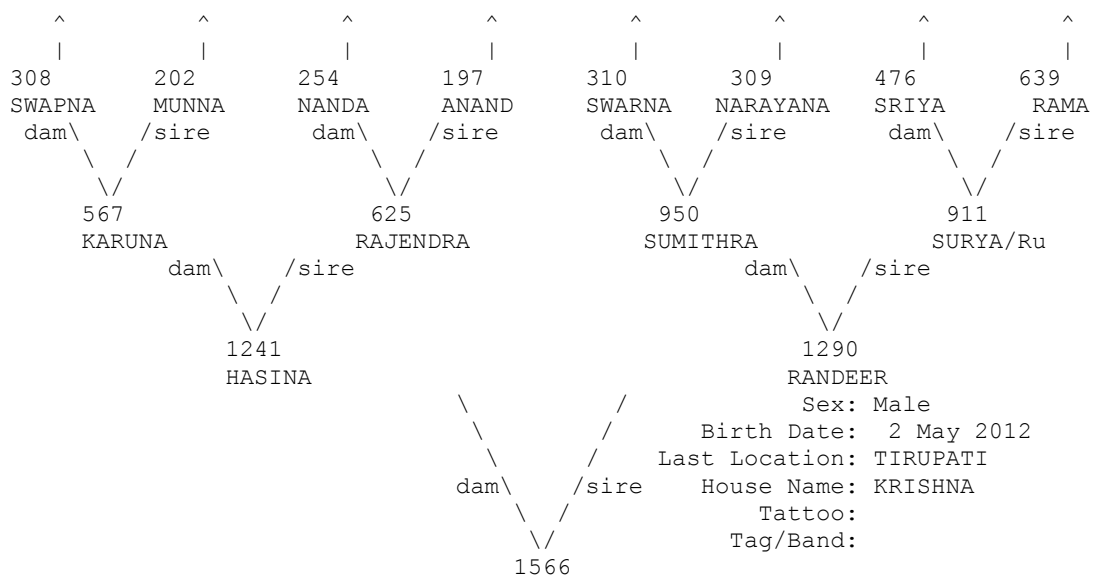

* Appear more than once...
 ^ Pedigree continues beyond top of page...

=====
 Taxon Name: PANTHERA TIGRIS Studbook Number: 1567
 =====

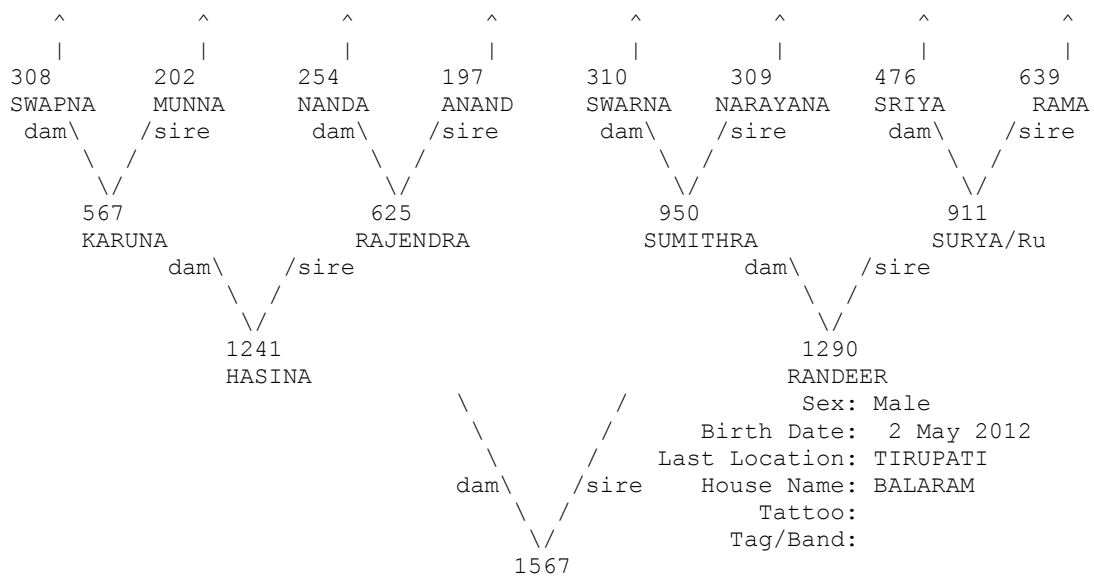

* Appear more than once...
 ^ Pedigree continues beyond top of page...

=====
 Taxon Name: PANTHERA TIGRIS Studbook Number: 1568
 =====

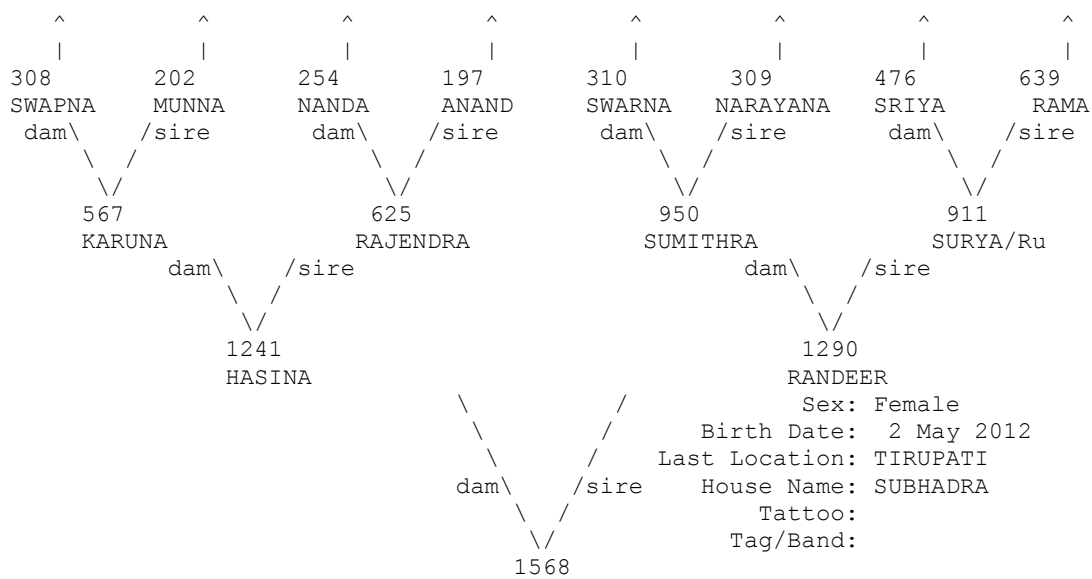

* Appear more than once...
 ^ Pedigree continues beyond top of page...

=====
 Taxon Name: PANTHERA TIGRIS Studbook Number: 1569
 =====

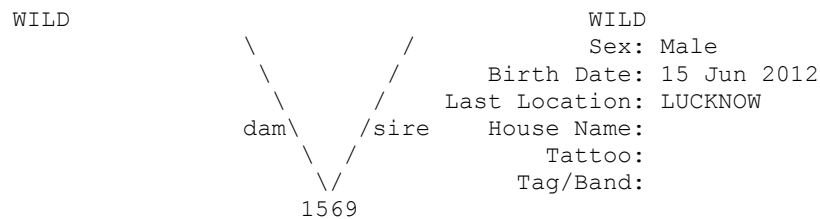

=====
 Taxon Name: PANTHERA TIGRIS Studbook Number: 1570
 =====

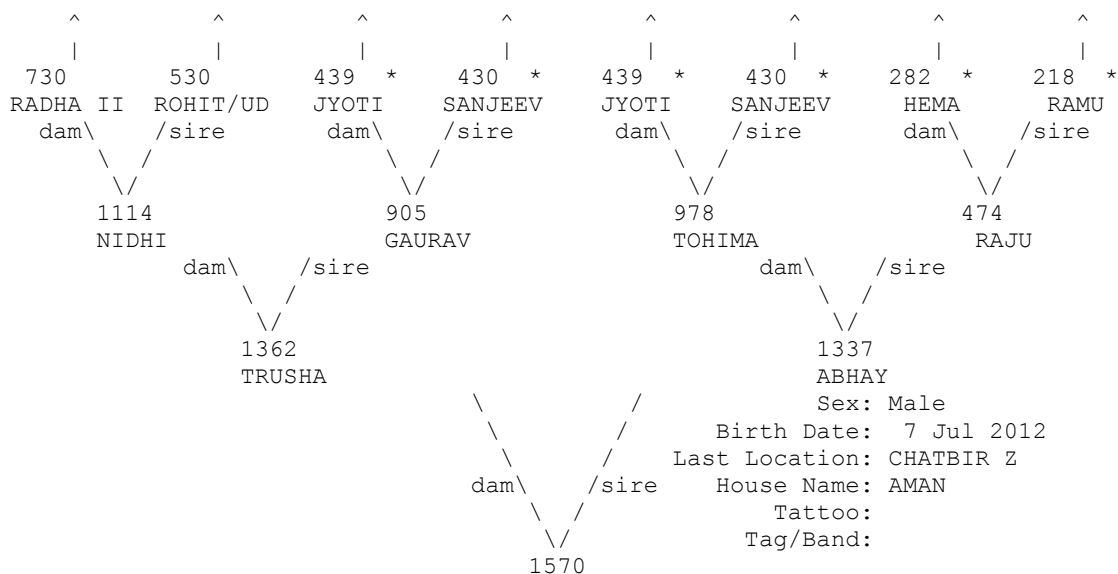

* Appear more than once...
 ^ Pedigree continues beyond top of page...

=====
 Taxon Name: PANTHERA TIGRIS Studbook Number: 1571
 =====

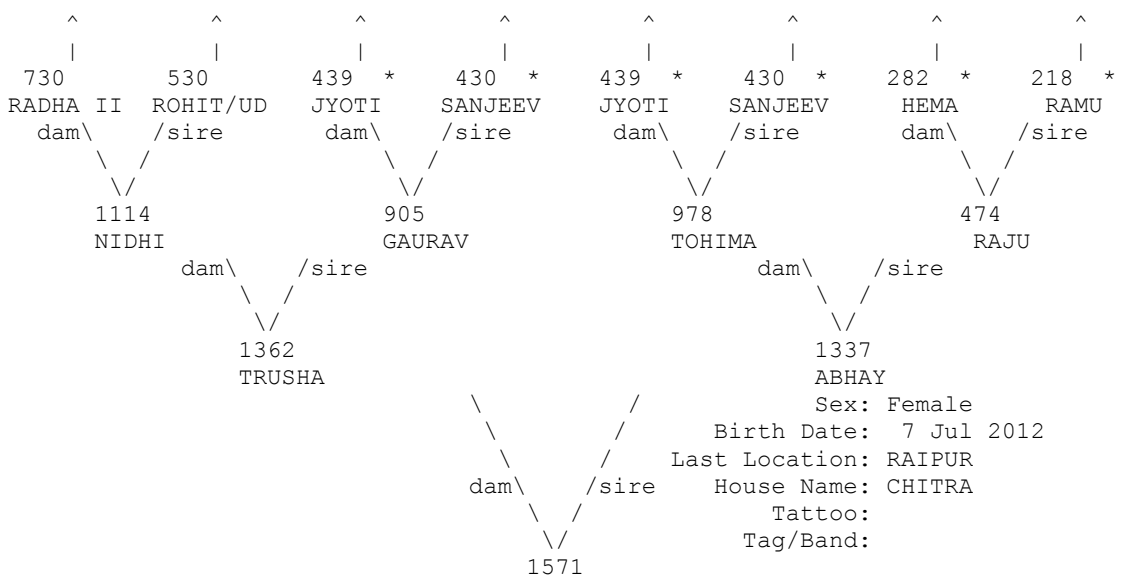

* Appear more than once...
 ^ Pedigree continues beyond top of page...

=====
 Taxon Name: PANTHERA TIGRIS Studbook Number: 1572
 =====

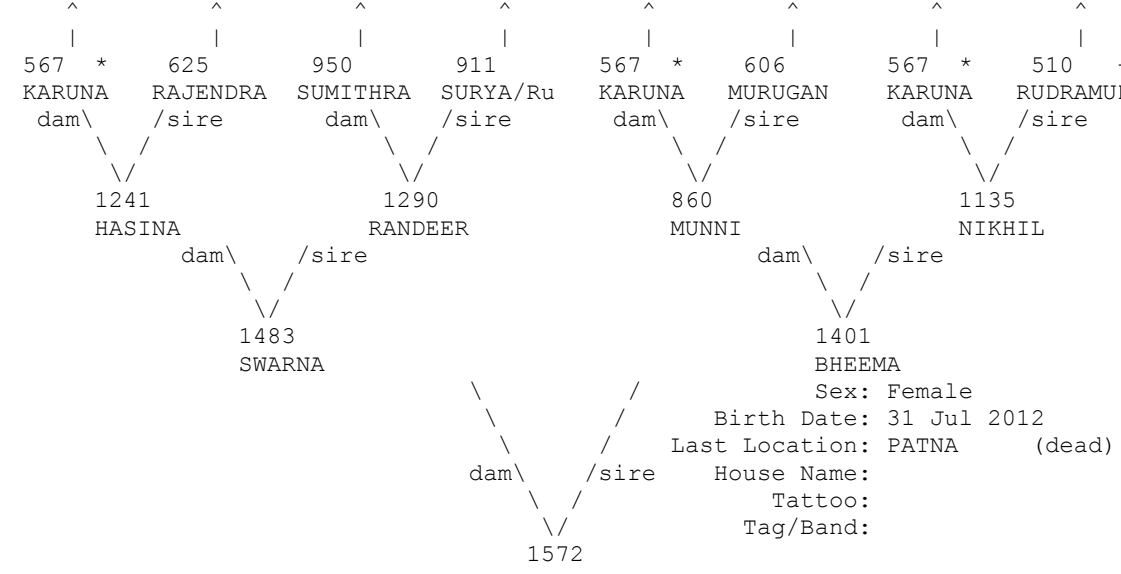

+ Wild-caught... * Appear more than once...
 ^ Pedigree continues beyond top of page...

=====
 Taxon Name: PANTHERA TIGRIS Studbook Number: 1573
 =====

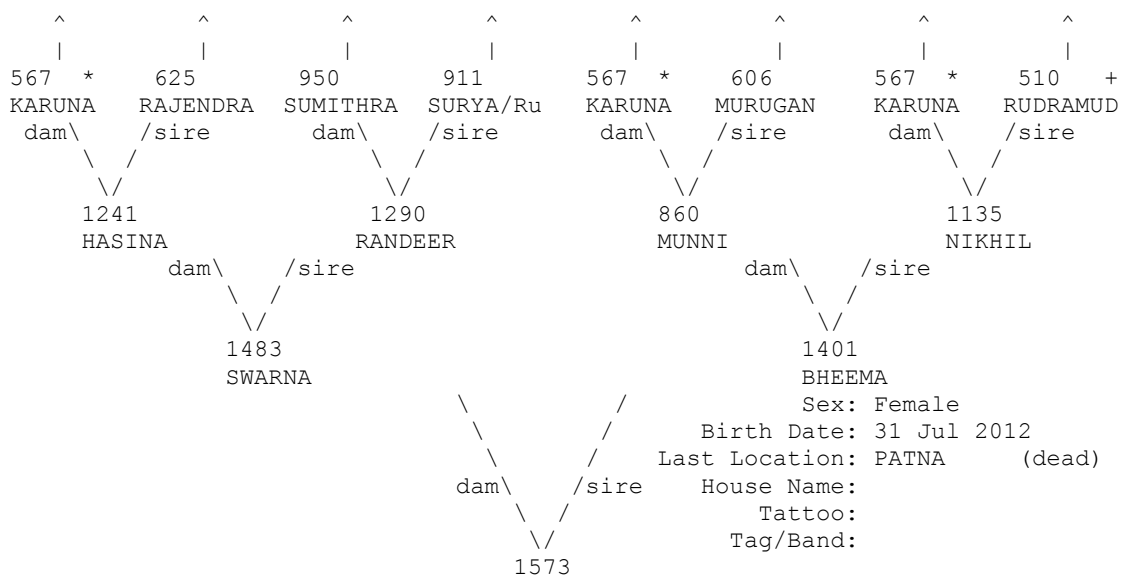

+ Wild-caught... * Appear more than once...
 ^ Pedigree continues beyond top of page...

=====
 Taxon Name: PANTHERA TIGRIS Studbook Number: 1574
 =====

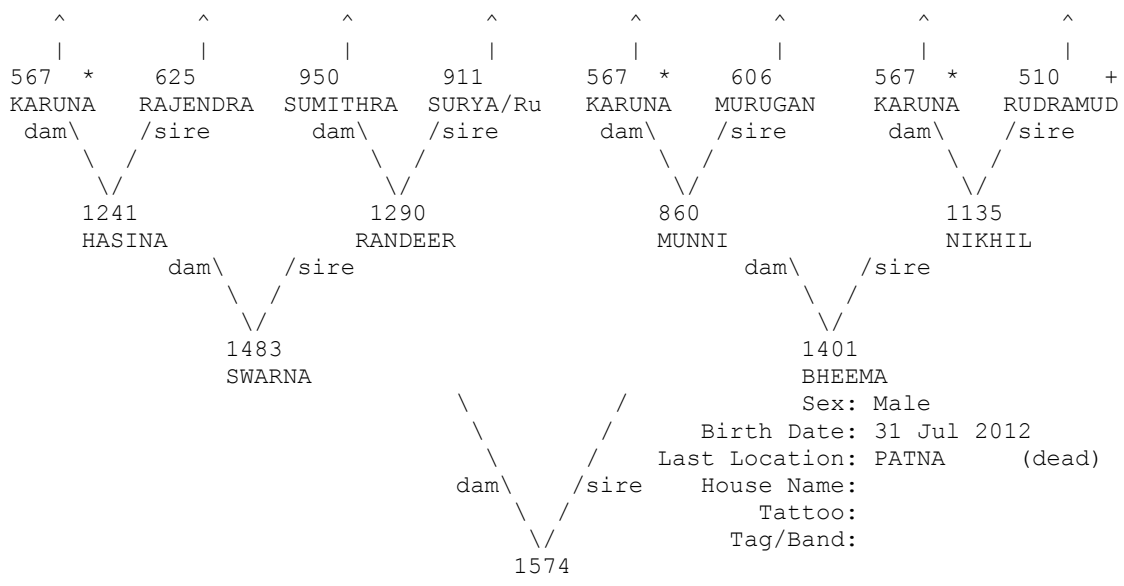

+ Wild-caught... * Appear more than once...
 ^ Pedigree continues beyond top of page...

=====
 Taxon Name: PANTHERA TIGRIS Studbook Number: 1575
 =====

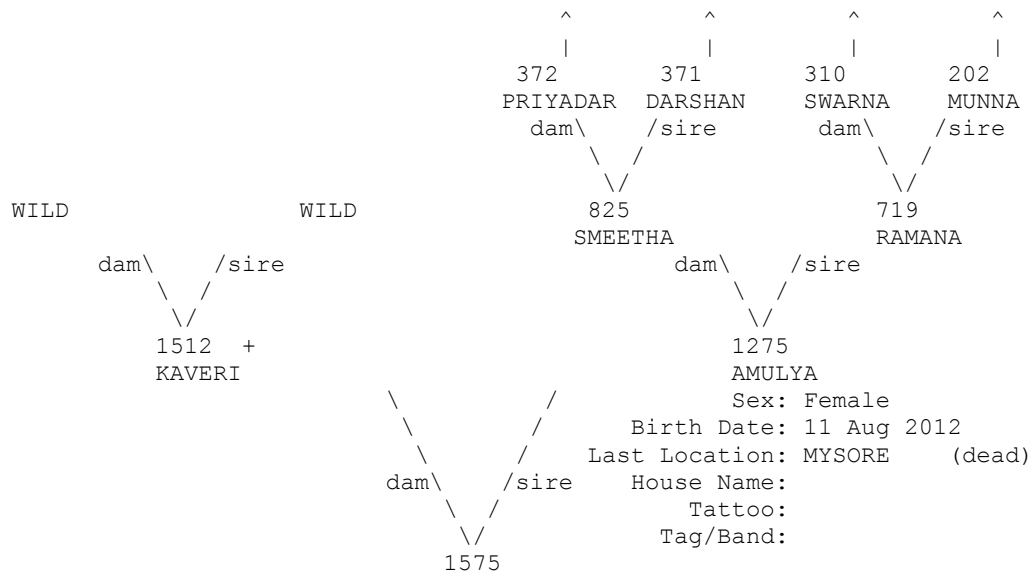

+ Wild-caught... * Appear more than once...
 ^ Pedigree continues beyond top of page...

=====
 Taxon Name: PANTHERA TIGRIS Studbook Number: 1576
 =====

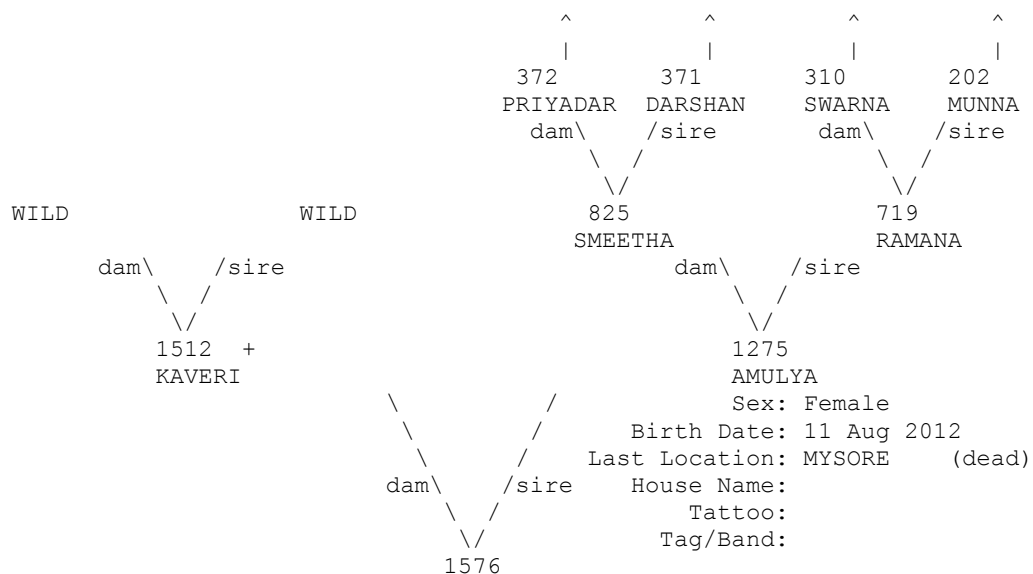

+ Wild-caught... * Appear more than once...
 ^ Pedigree continues beyond top of page...

=====
 Taxon Name: PANTHERA TIGRIS Studbook Number: 1577
 =====

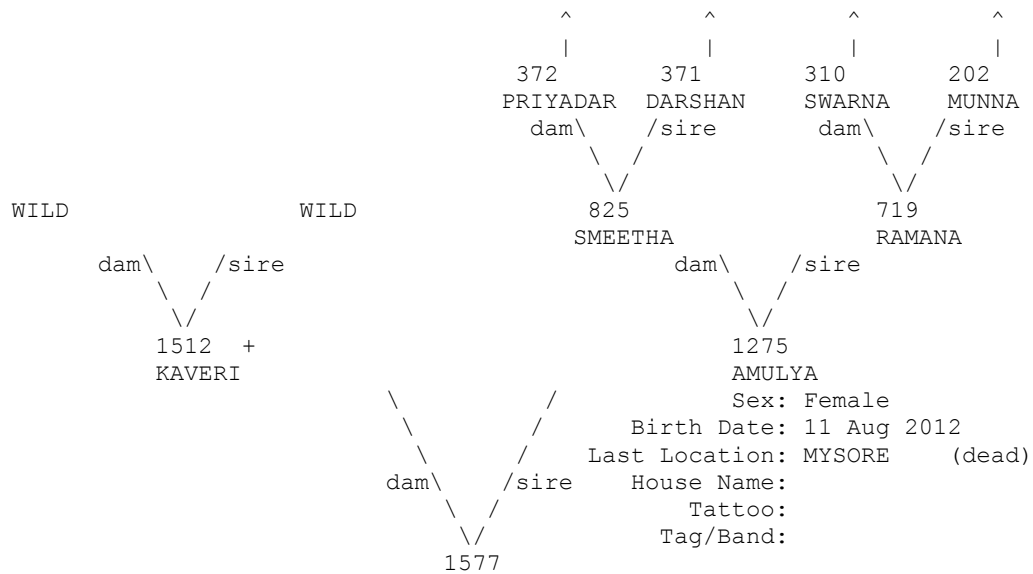

+ Wild-caught... * Appear more than once...
 ^ Pedigree continues beyond top of page...

=====
 Taxon Name: PANTHERA TIGRIS Studbook Number: 1578
 =====

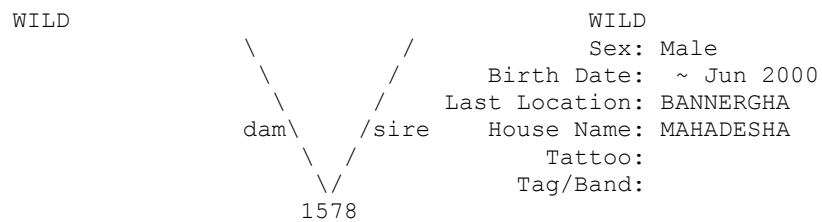

=====
 Taxon Name: PANTHERA TIGRIS Studbook Number: 1579
 =====

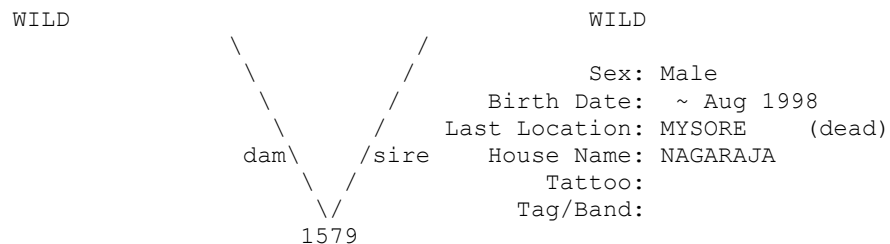

=====
 Taxon Name: PANTHERA TIGRIS Studbook Number: 1580
 =====

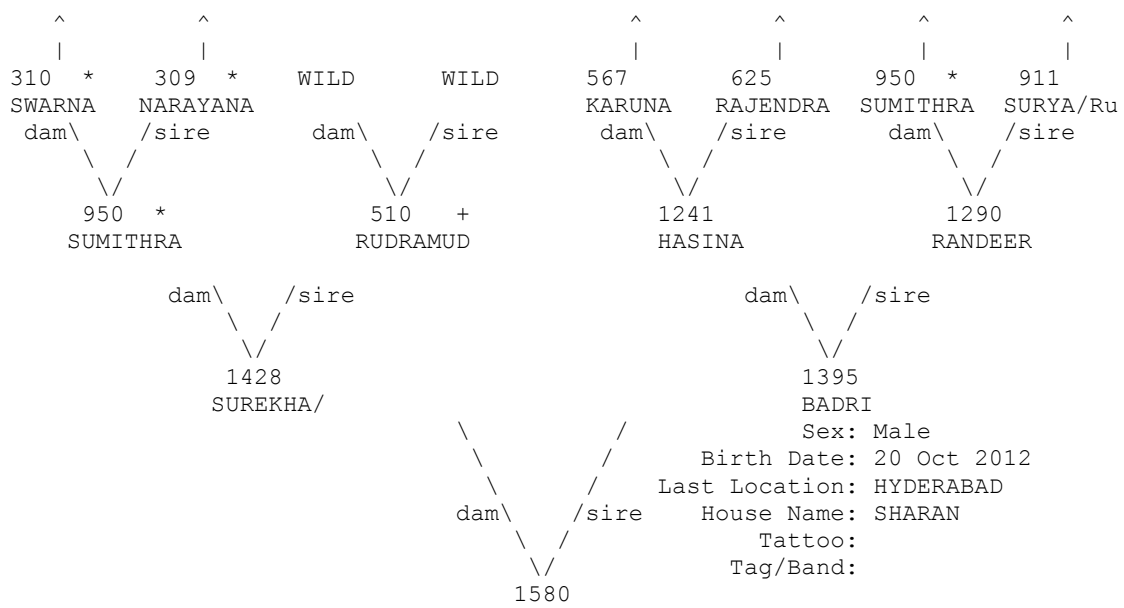

+ Wild-caught... * Appear more than once...
 ^ Pedigree continues beyond top of page...

=====
 Taxon Name: PANTHERA TIGRIS Studbook Number: 1581
 =====

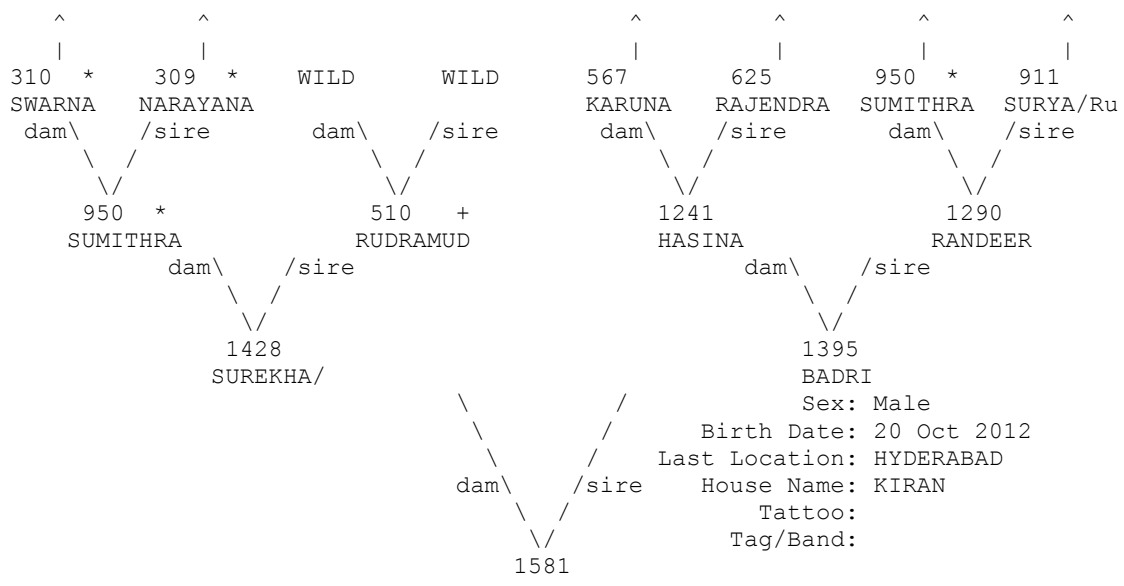

+ Wild-caught... * Appear more than once...
 ^ Pedigree continues beyond top of page...

=====
 Taxon Name: PANTHERA TIGRIS Studbook Number: 1582
 =====

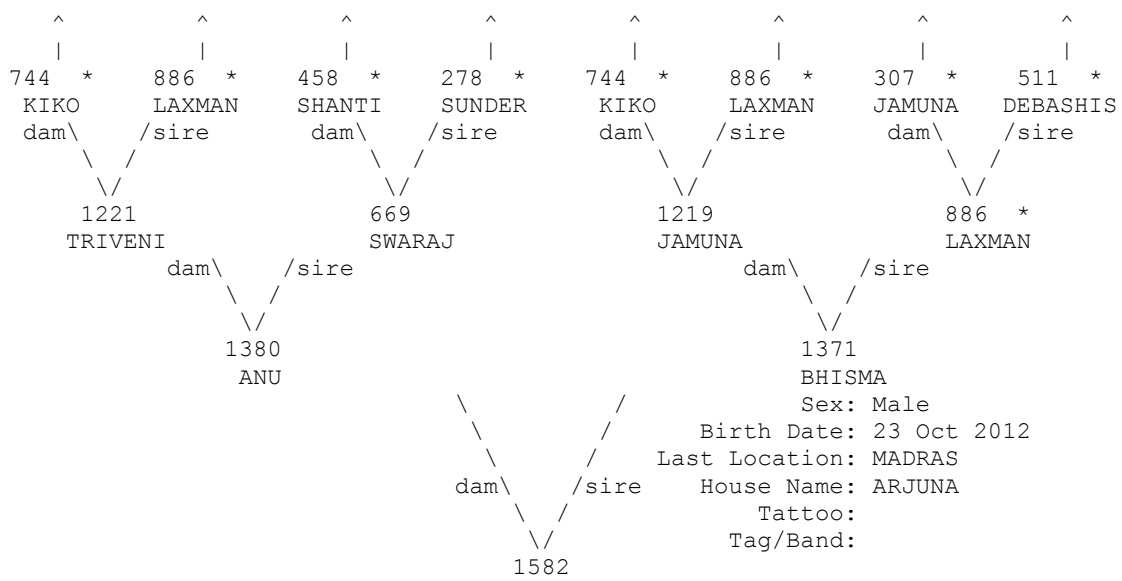

* Appear more than once...
 ^ Pedigree continues beyond top of page...

=====
 Taxon Name: PANTHERA TIGRIS Studbook Number: 1583
 =====

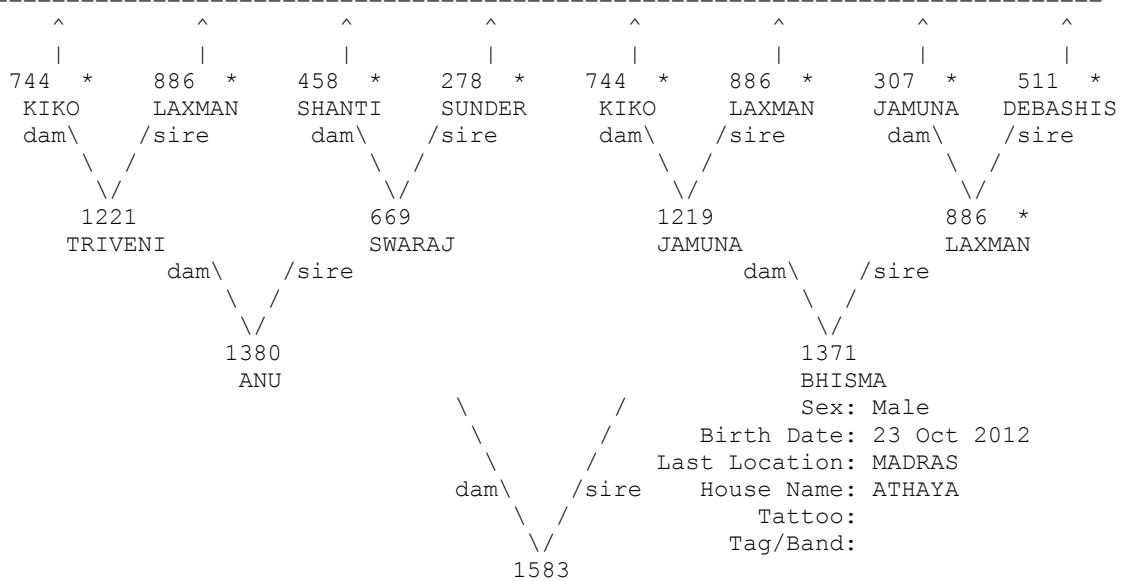

* Appear more than once...
 ^ Pedigree continues beyond top of page...

=====
 Taxon Name: PANTHERA TIGRIS Studbook Number: 1584
 =====

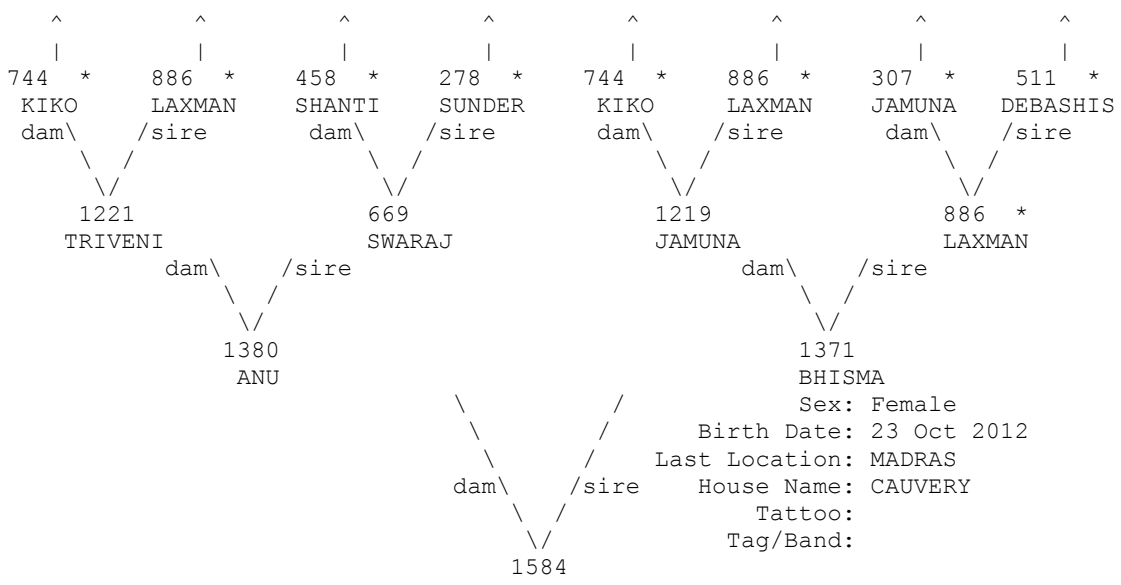

* Appear more than once...
 ^ Pedigree continues beyond top of page...

=====
 Taxon Name: PANTHERA TIGRIS Studbook Number: 1585
 =====

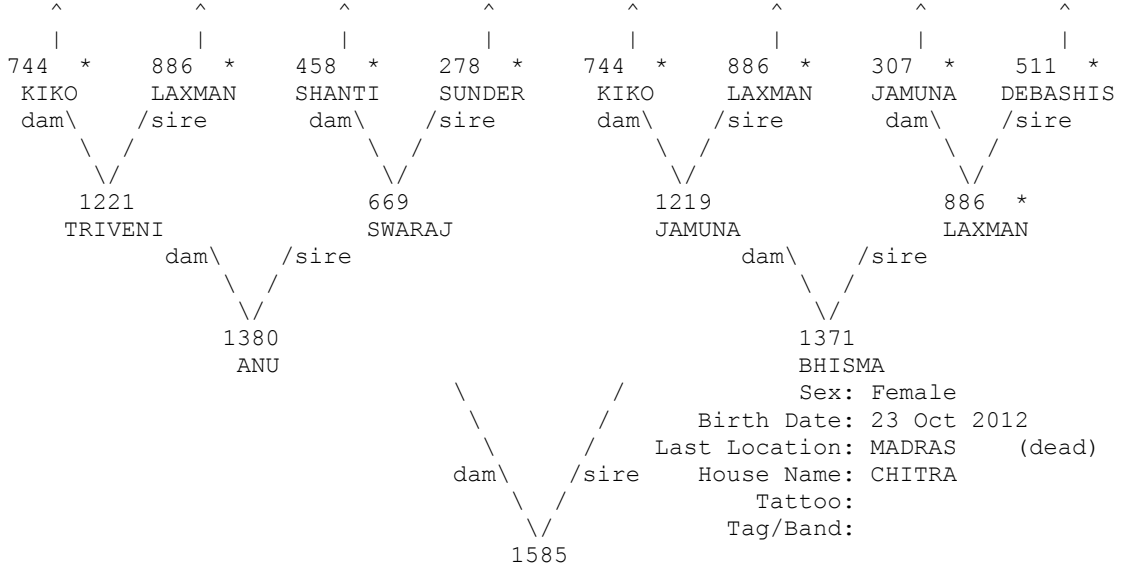

* Appear more than once...
 ^ Pedigree continues beyond top of page...

=====
 Taxon Name: PANTHERA TIGRIS Studbook Number: 1586
 =====

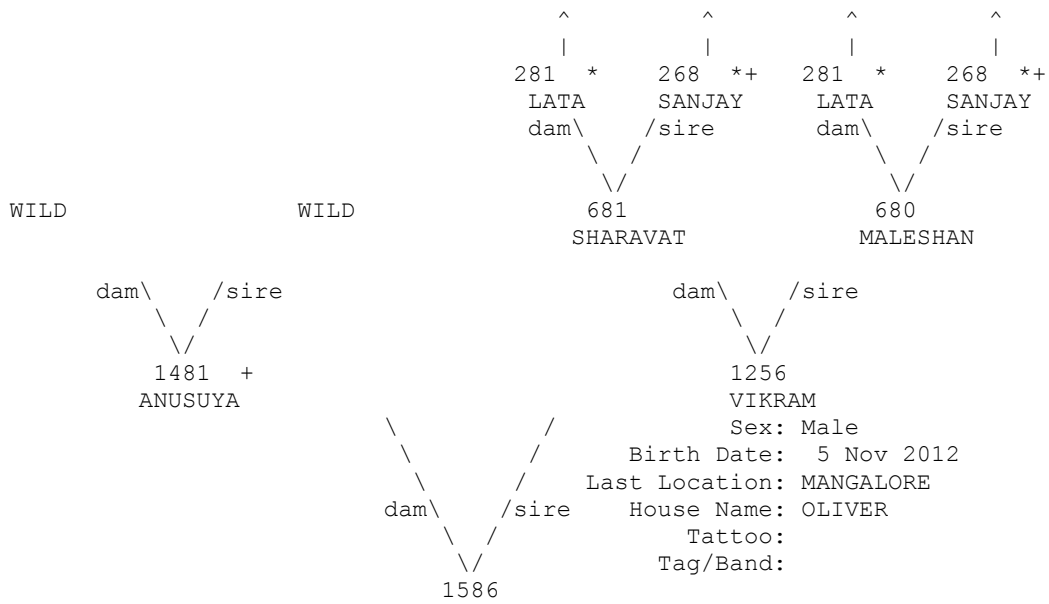

+ Wild-caught... * Appear more than once...
 ^ Pedigree continues beyond top of page...

=====
 Taxon Name: PANTHERA TIGRIS Studbook Number: 1587
 =====

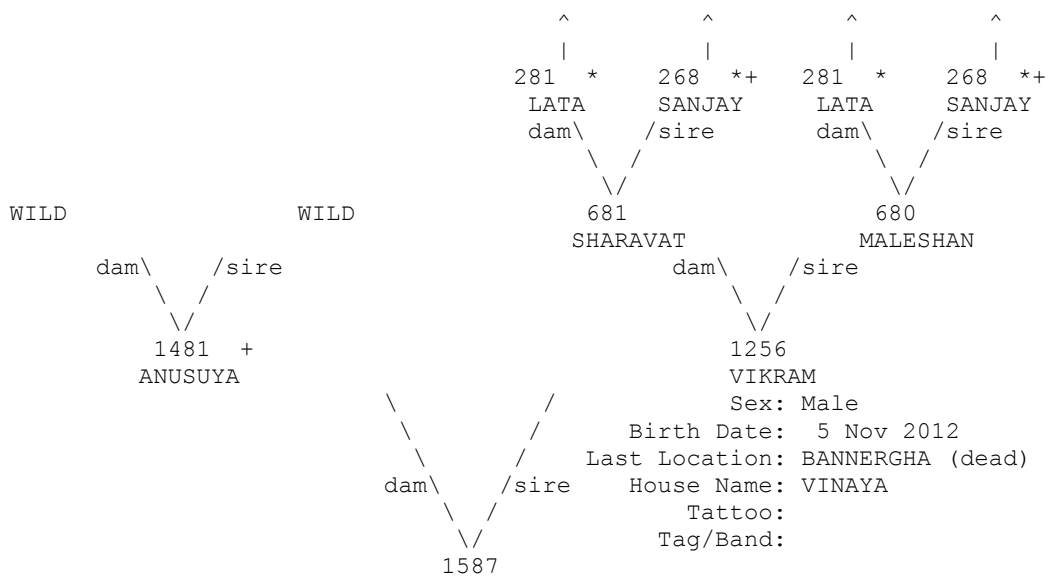

+ Wild-caught... * Appear more than once...
 ^ Pedigree continues beyond top of page...

=====
 Taxon Name: PANTHERA TIGRIS Studbook Number: 1588
 =====

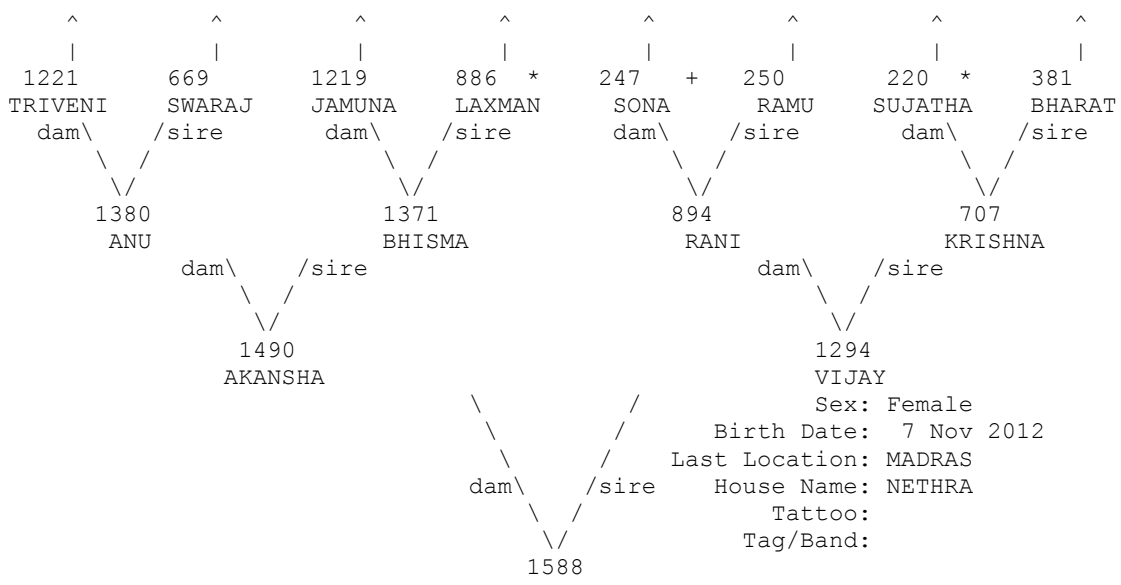

+ Wild-caught... * Appear more than once...
 ^ Pedigree continues beyond top of page...

=====
 Taxon Name: PANTHERA TIGRIS Studbook Number: 1589
 =====

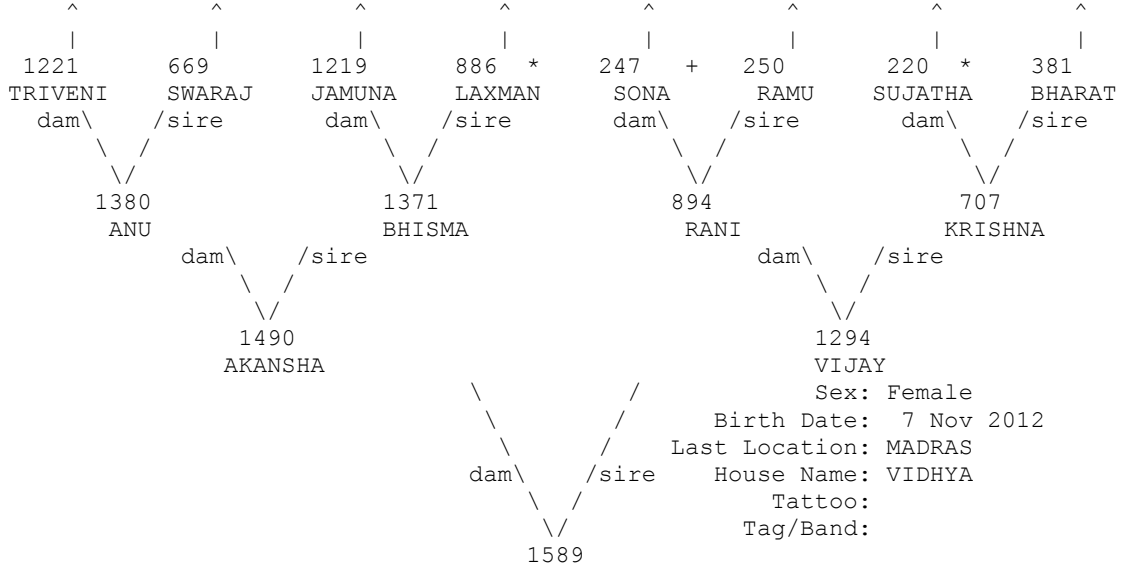

+ Wild-caught... * Appear more than once...
 ^ Pedigree continues beyond top of page...

=====
 Taxon Name: PANTHERA TIGRIS Studbook Number: 1590
 =====

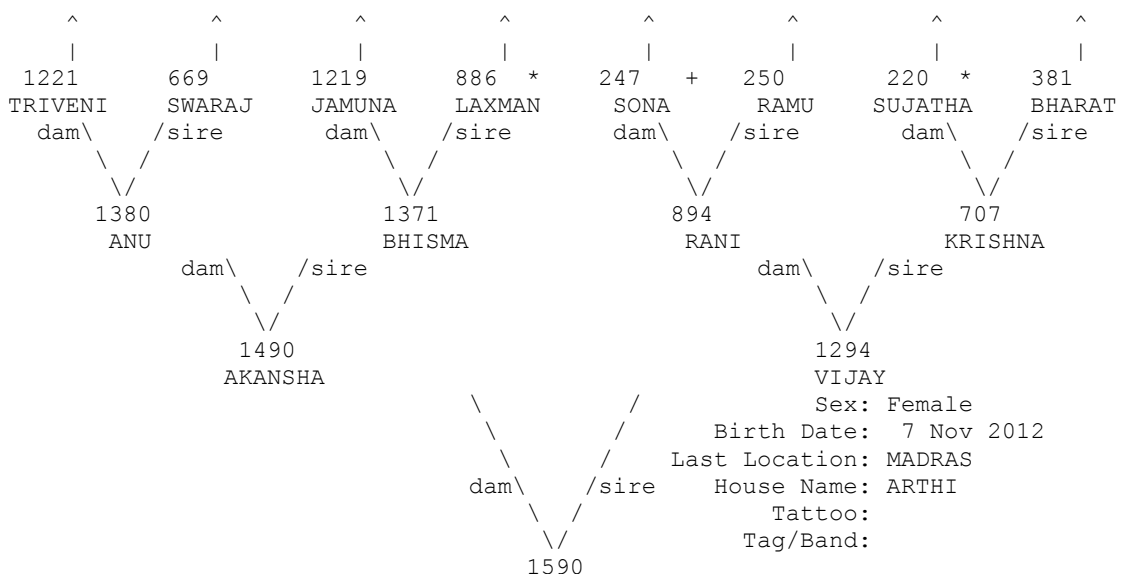

+ Wild-caught... * Appear more than once...
 ^ Pedigree continues beyond top of page...

=====
 Taxon Name: PANTHERA TIGRIS Studbook Number: 1591
 =====

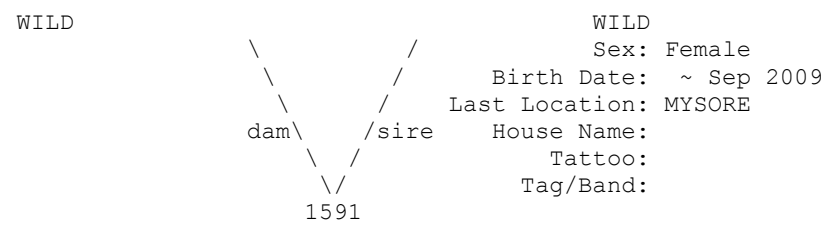

=====
 Taxon Name: PANTHERA TIGRIS Studbook Number: 1592
 =====

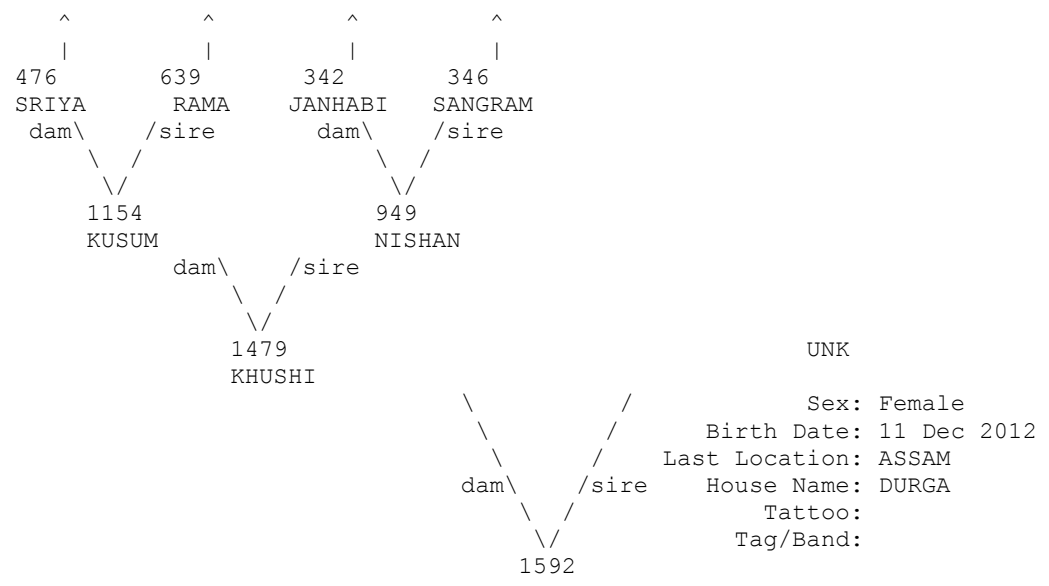

* Appear more than once...
 ^ Pedigree continues beyond top of page...

=====
Taxon Name: PANTHERA TIGRIS Studbook Number: 1593
=====

WILD

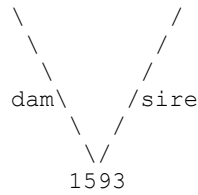

WILD
Sex: Female
Birth Date: ~ 2012
Last Location: ITANAGAR
House Name: CHIPI
Tattoo:
Tag/Band:

=====
Taxon Name: PANTHERA TIGRIS Studbook Number: 1594
=====

WILD

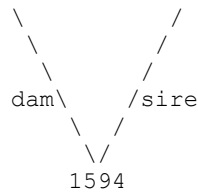

WILD
Sex: Male
Birth Date: ~ 2012
Last Location: ITANAGAR
House Name: IPRA
Tattoo:
Tag/Band:

=====
Taxon Name: PANTHERA TIGRIS Studbook Number: 1595
=====

WILD

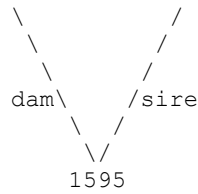

WILD
Sex: Male
Birth Date: 1 Jan 2013
Last Location: VANVIHAR
House Name: BANDHU
Tattoo:
Tag/Band:

=====
Taxon Name: PANTHERA TIGRIS Studbook Number: 1596
=====

WILD

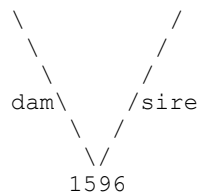

WILD
Sex: Female
Birth Date: 15 Aug 2012
Last Location: LUCKNOW
House Name: MAILANI-1
Tattoo:
Tag/Band:

=====
 Taxon Name: PANTHERA TIGRIS Studbook Number: 1597
 =====

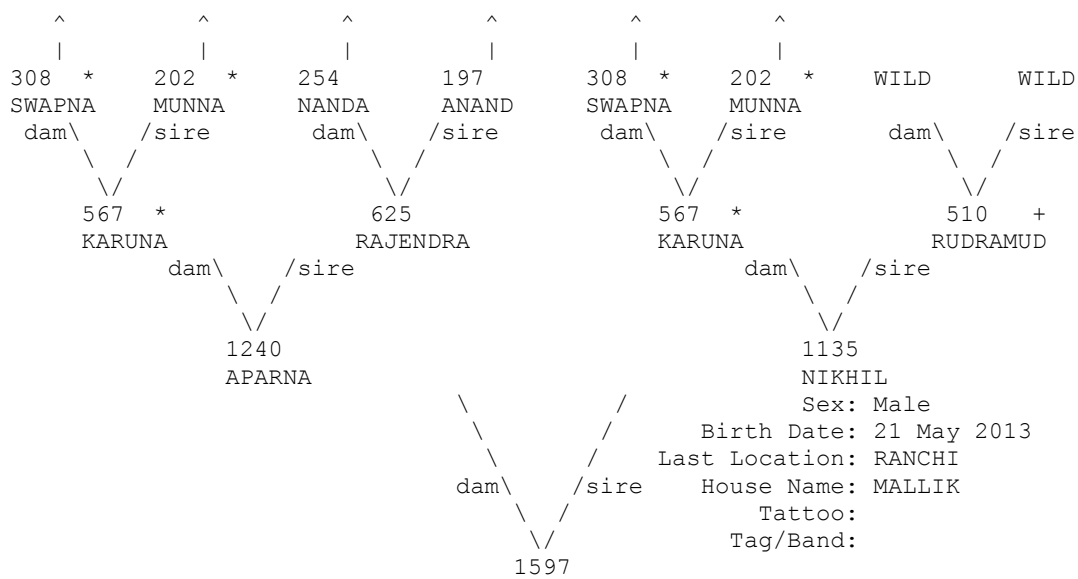

+ Wild-caught... * Appear more than once...
 ^ Pedigree continues beyond top of page...

=====
 Taxon Name: PANTHERA TIGRIS Studbook Number: 1598
 =====

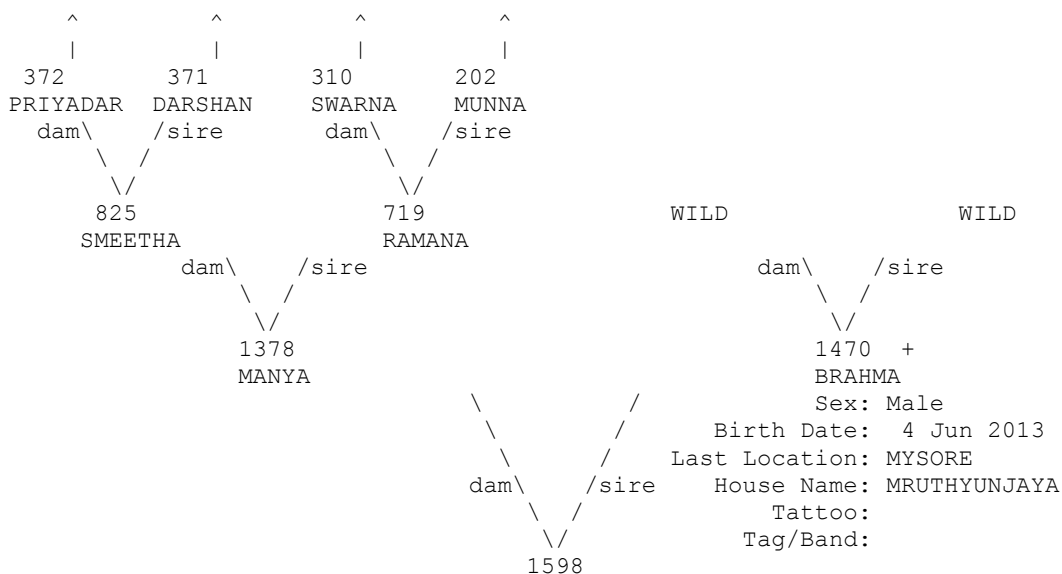

+ Wild-caught... * Appear more than once...
 ^ Pedigree continues beyond top of page...

=====
 Taxon Name: PANTHERA TIGRIS Studbook Number: 1599
 =====

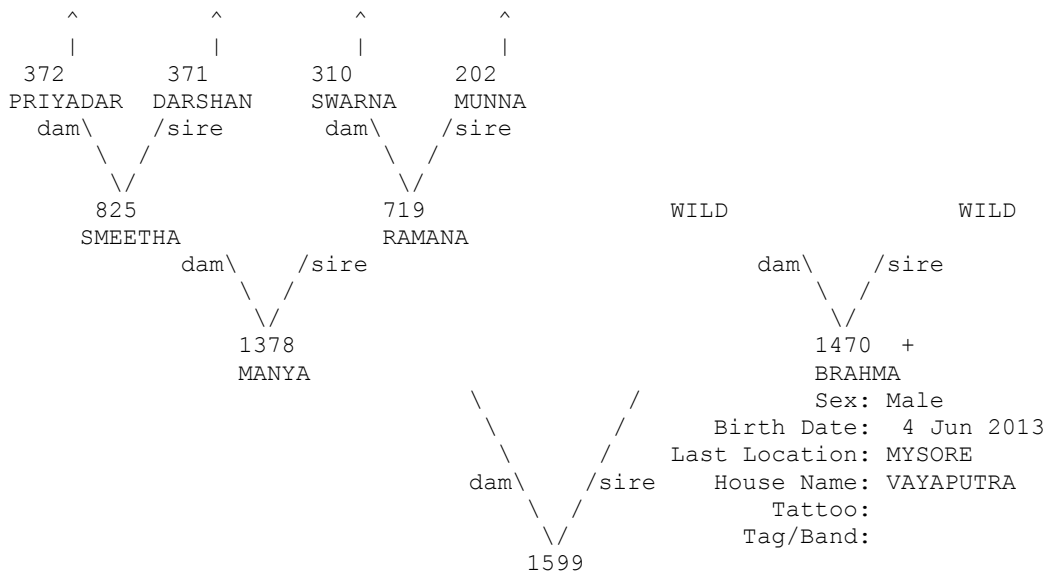

+ Wild-caught... * Appear more than once...
 ^ Pedigree continues beyond top of page...

=====
 Taxon Name: PANTHERA TIGRIS Studbook Number: 1600
 =====

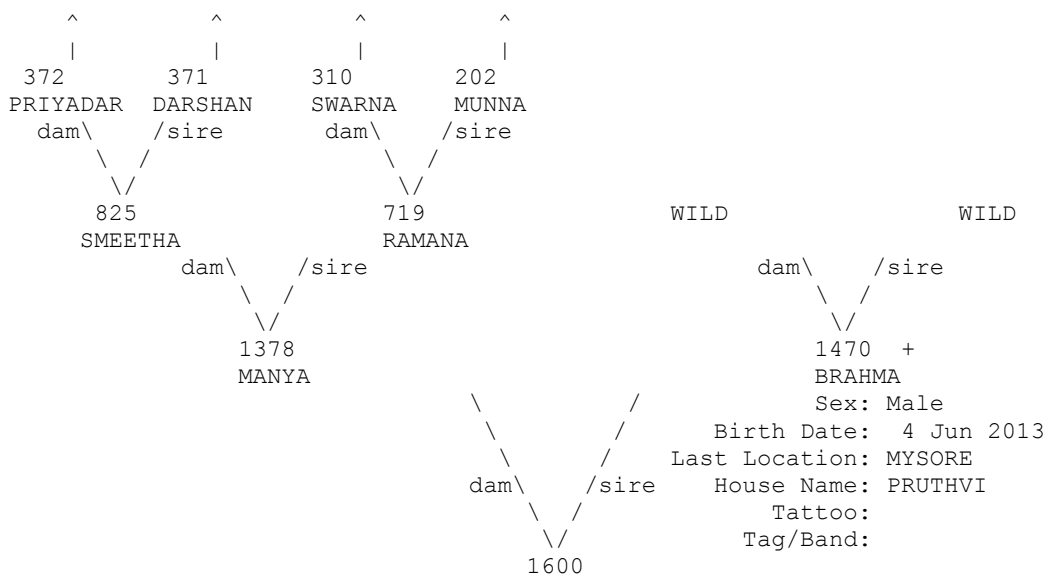

+ Wild-caught... * Appear more than once...
 ^ Pedigree continues beyond top of page...

=====
 Taxon Name: PANTHERA TIGRIS Studbook Number: 1601
 =====

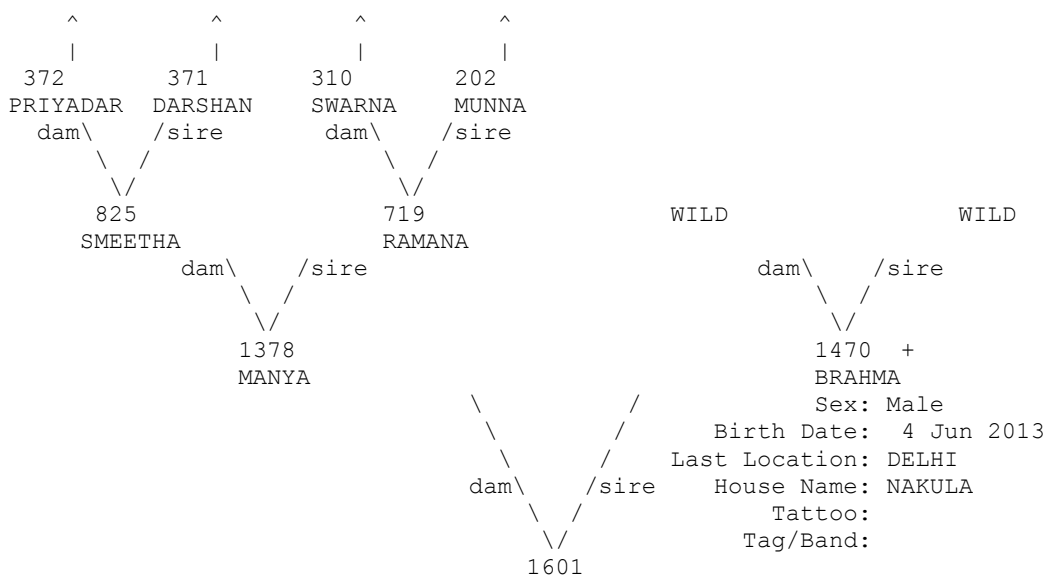

+ Wild-caught... * Appear more than once...
 ^ Pedigree continues beyond top of page...

=====
 Taxon Name: PANTHERA TIGRIS Studbook Number: 1602
 =====

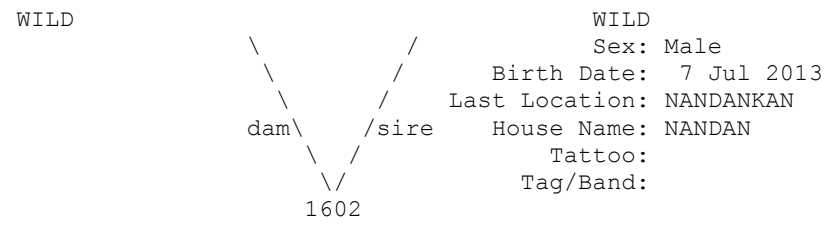

=====
 Taxon Name: PANTHERA TIGRIS Studbook Number: 1603
 =====

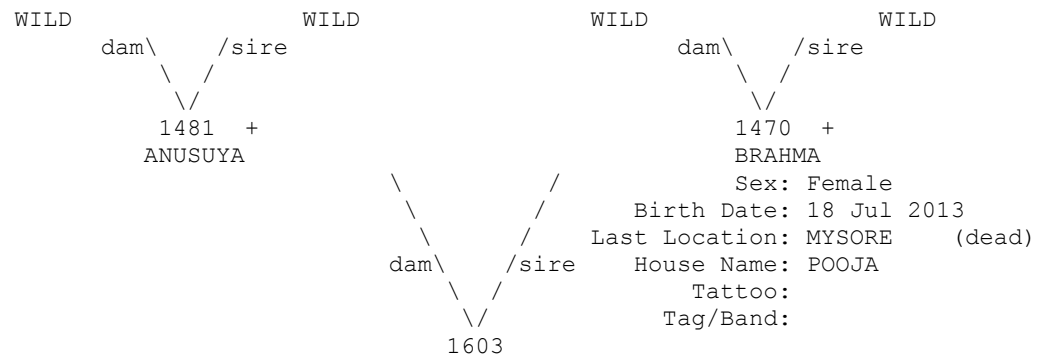

+ Wild-caught...

=====

Taxon Name: PANTHERA TIGRIS Studbook Number: 1604

=====

WILD	dam\ \ /	WILD	/sire	WILD	dam\ \ /	WILD	/sire
	1481 +				1470 +		
	ANUSUYA				BRAHMA		
					Sex: Female		
					Birth Date: 18 Jul 2013		
					Last Location: MYSORE (dead)		
					House Name: JYOTHI		
					Tattoo:		
					Tag/Band:		
				dam\ \ /			
				1604			

+ Wild-caught...

=====

Taxon Name: PANTHERA TIGRIS Studbook Number: 1605

=====

WILD	dam\ \ /	WILD	/sire	WILD	dam\ \ /	WILD	/sire
	1481 +				1470 +		
	ANUSUYA				BRAHMA		
					Sex: Female		
					Birth Date: 18 Jul 2013		
					Last Location: MYSORE (dead)		
					House Name:		
					Tattoo:		
					Tag/Band:		
				dam\ \ /			
				1605			

+ Wild-caught...

=====

Taxon Name: PANTHERA TIGRIS Studbook Number: 1606

=====

WILD	dam\ \ /	WILD	/sire	WILD	dam\ \ /	WILD	/sire
	1481 +				1470 +		
	ANUSUYA				BRAHMA		
					Sex: Female		
					Birth Date: 18 Jul 2013		
					Last Location: MYSORE (dead)		
					House Name:		
					Tattoo:		
					Tag/Band:		
				dam\ \ /			
				1606			

+ Wild-caught...

=====

Taxon Name: PANTHERA TIGRIS Studbook Number: 1607

=====

UNK	dam\ \ /	UNK	/sire	UNK	Sex: Male
					Birth Date: 28 Jul 2013
					Last Location: KANPUR
					House Name: LUV
					Tattoo:
					Tag/Band:
				dam\ \ /	
				1607	

=====
 Taxon Name: PANTHERA TIGRIS Studbook Number: 1608
 =====

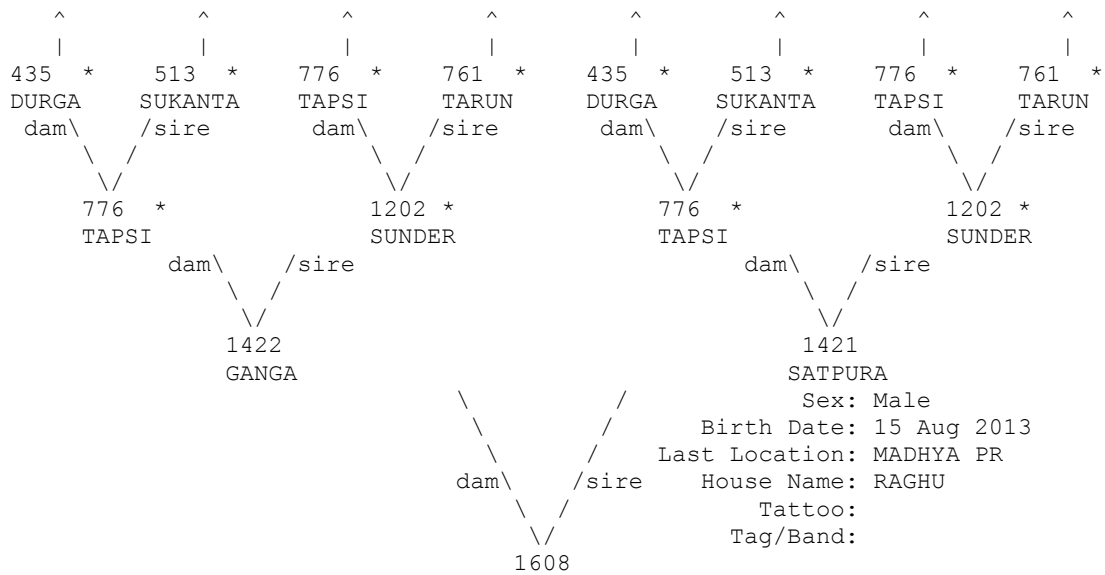

* Appear more than once...
 ^ Pedigree continues beyond top of page...

=====
 Taxon Name: PANTHERA TIGRIS Studbook Number: 1609
 =====

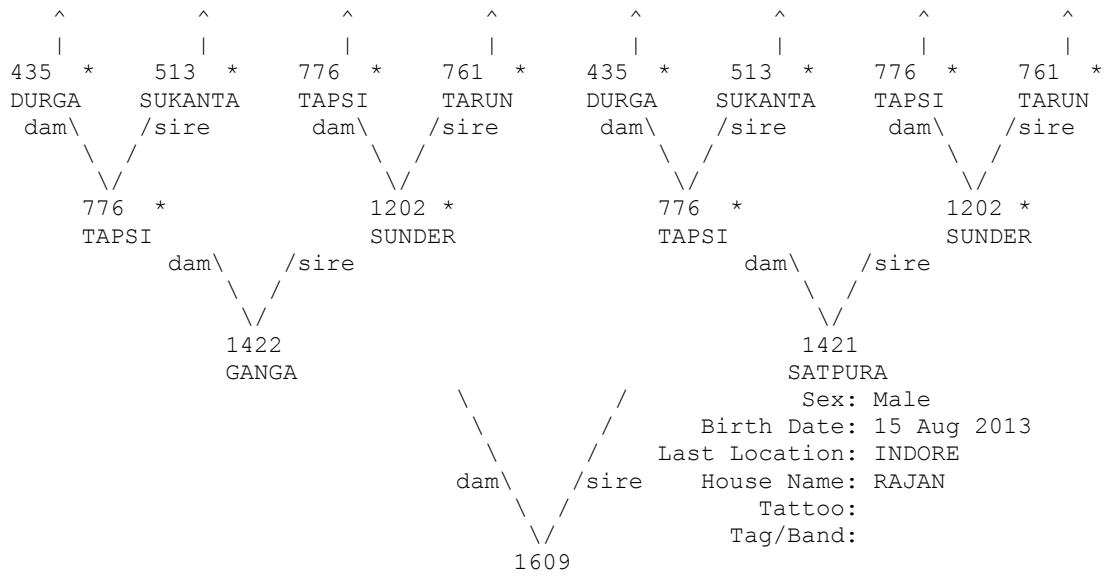

* Appear more than once...
 ^ Pedigree continues beyond top of page...

=====
 Taxon Name: PANTHERA TIGRIS Studbook Number: 1610
 =====

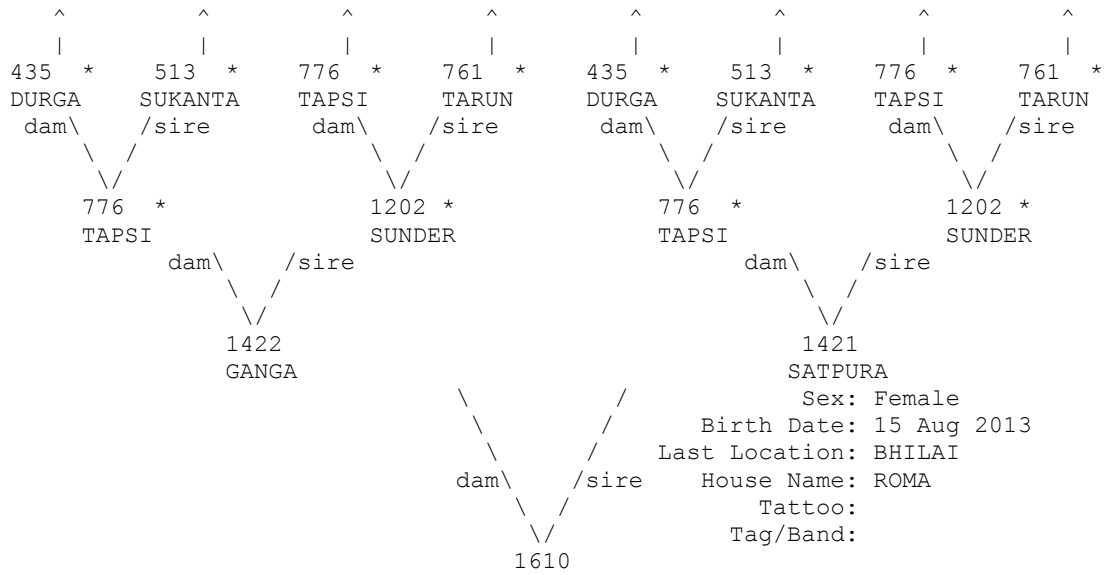

* Appear more than once...
 ^ Pedigree continues beyond top of page...

=====
 Taxon Name: PANTHERA TIGRIS Studbook Number: 1611
 =====

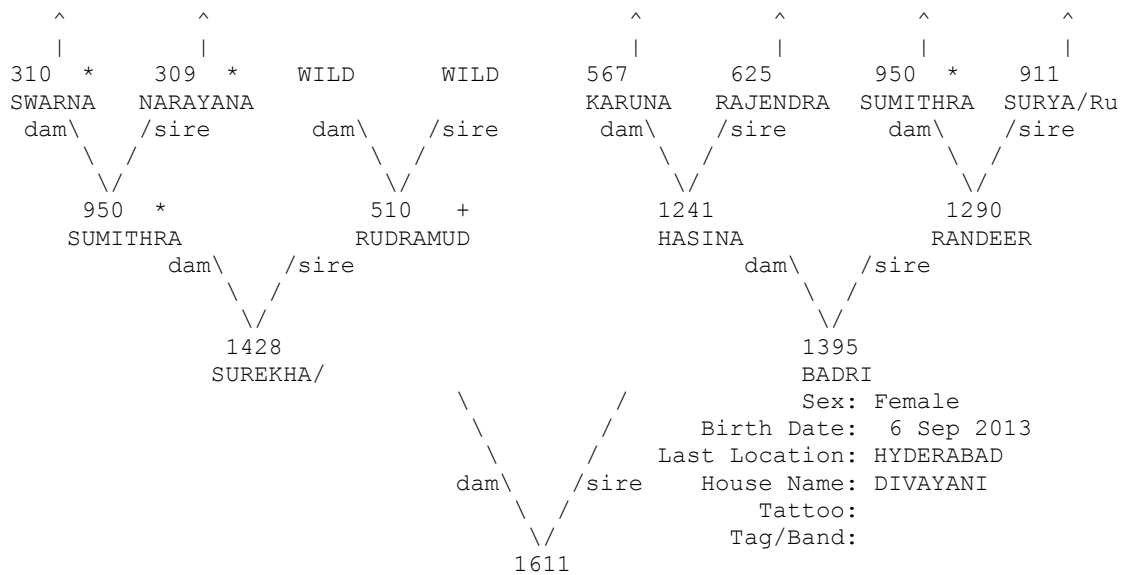

+ Wild-caught... * Appear more than once...
 ^ Pedigree continues beyond top of page...

=====
 Taxon Name: PANTHERA TIGRIS Studbook Number: 1612
 =====

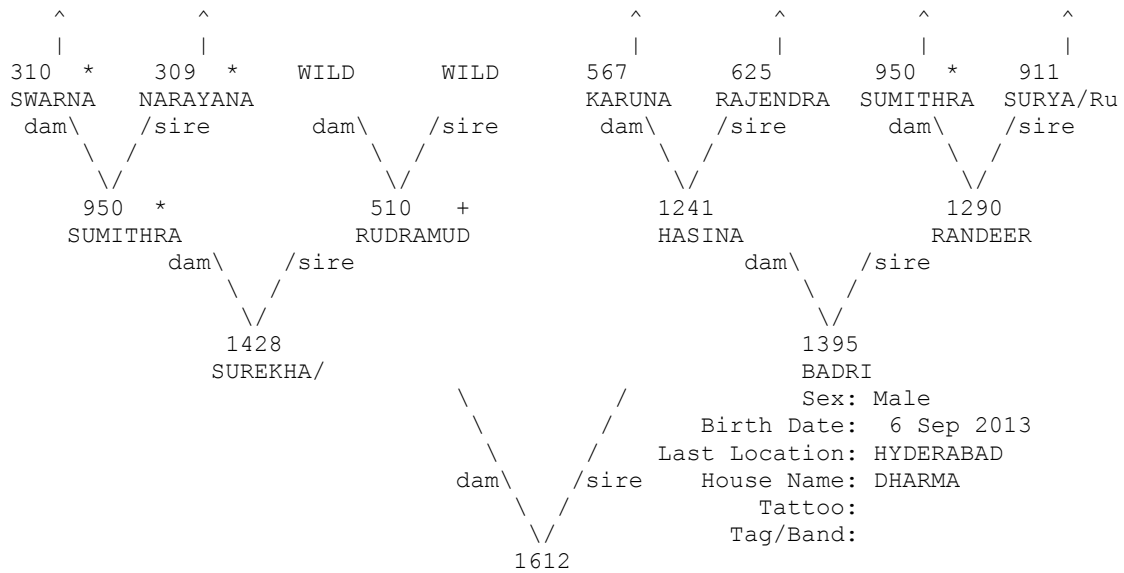

+ Wild-caught... * Appear more than once...
 ^ Pedigree continues beyond top of page...

=====
 Taxon Name: PANTHERA TIGRIS Studbook Number: 1613
 =====

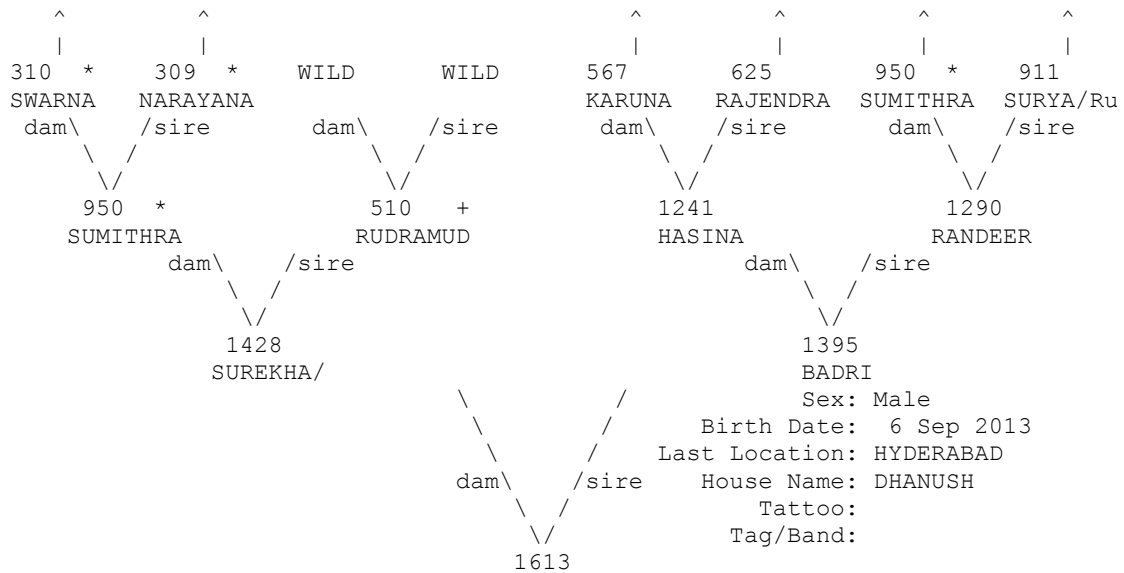

+ Wild-caught... * Appear more than once...
 ^ Pedigree continues beyond top of page...

=====
 Taxon Name: PANTHERA TIGRIS Studbook Number: 1614
 =====

WILD

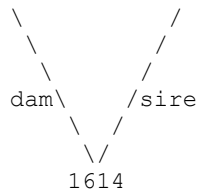

WILD
 Sex: Female
 Birth Date: ~ Dec 2013
 Last Location: MADRAS
 House Name: UTHIRA
 Tattoo:
 Tag/Band:

=====
 Taxon Name: PANTHERA TIGRIS Studbook Number: 1615
 =====

WILD

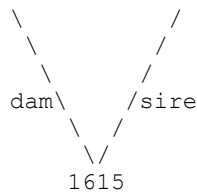

WILD
 Sex: Male
 Birth Date: ~ Apr 2002
 Last Location: MYSORE
 House Name: SHIVA
 Tattoo:
 Tag/Band:

=====
 Taxon Name: PANTHERA TIGRIS Studbook Number: 1616
 =====

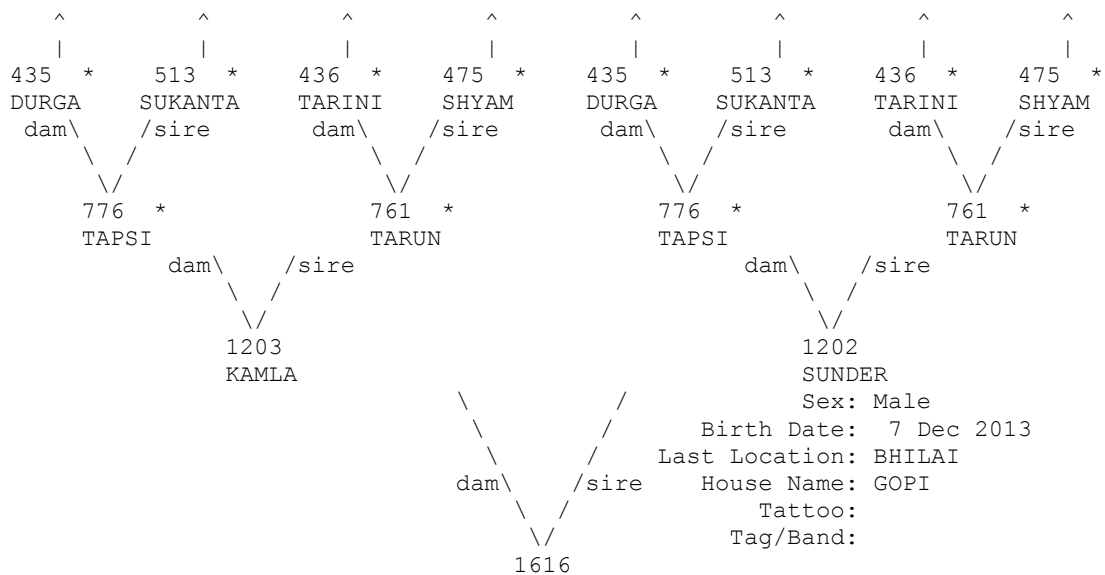

* Appear more than once...
 ^ Pedigree continues beyond top of page...

=====
 Taxon Name: PANTHERA TIGRIS Studbook Number: 1620
 =====

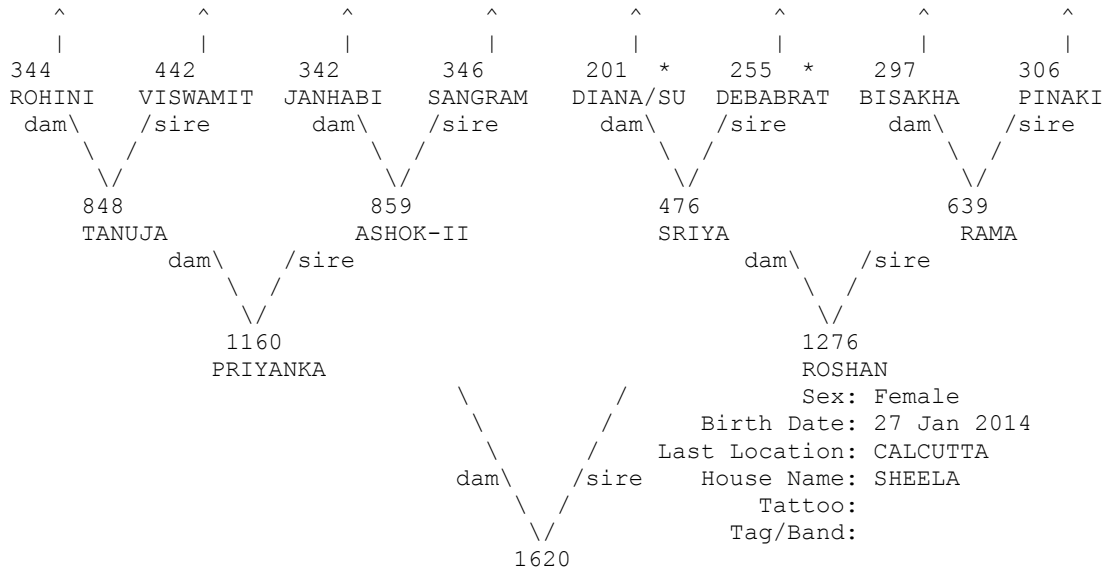

* Appear more than once...
 ^ Pedigree continues beyond top of page...

=====
 Taxon Name: PANTHERA TIGRIS Studbook Number: 1621
 =====

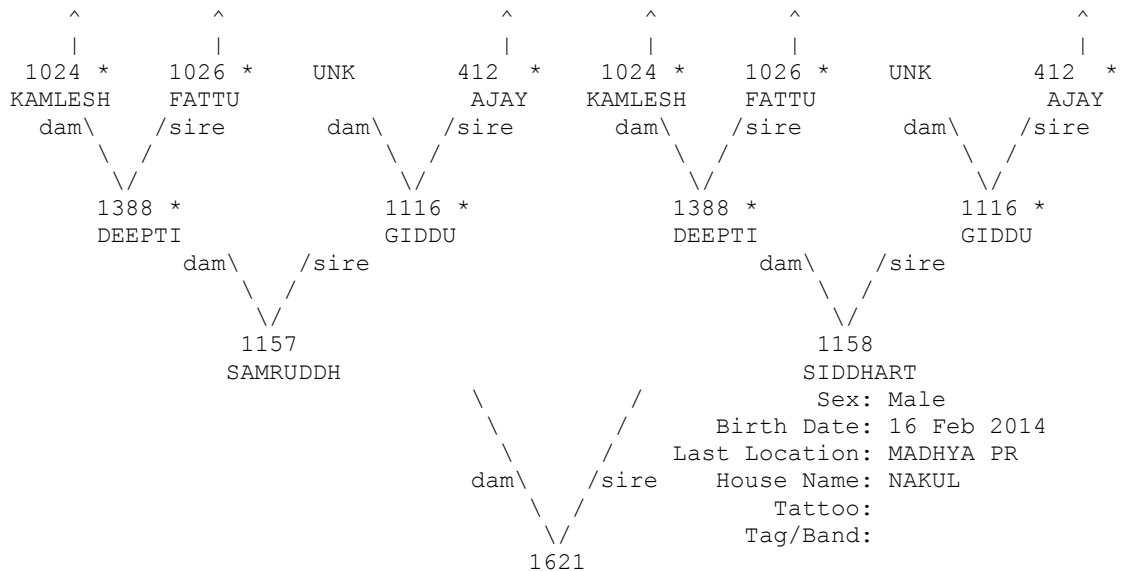

* Appear more than once...
 ^ Pedigree continues beyond top of page...

=====
 Taxon Name: PANTHERA TIGRIS Studbook Number: 1622
 =====

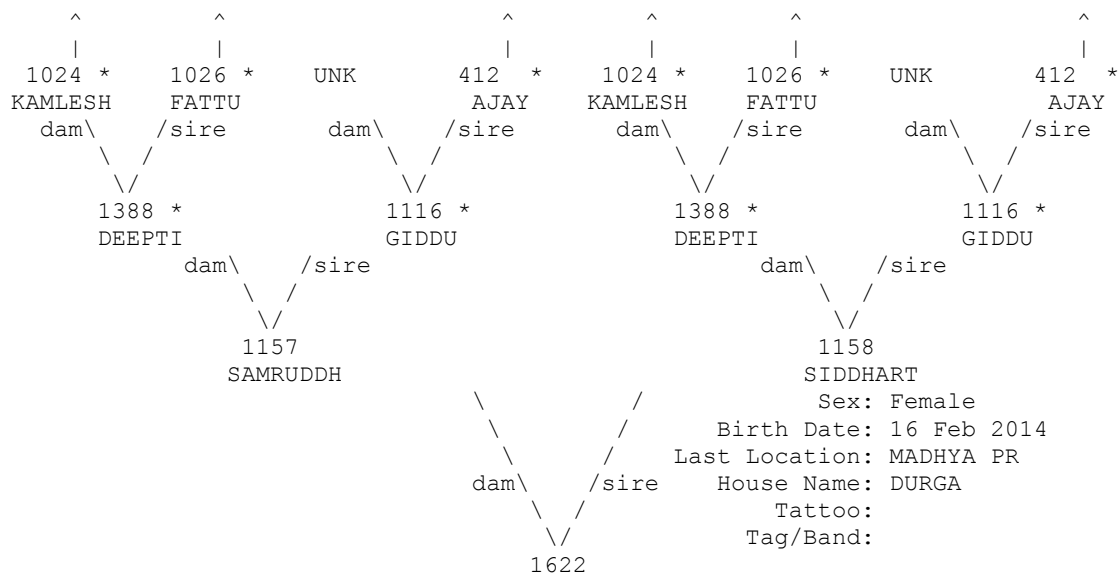

* Appear more than once...
 ^ Pedigree continues beyond top of page...

=====
 Taxon Name: PANTHERA TIGRIS Studbook Number: 1623
 =====

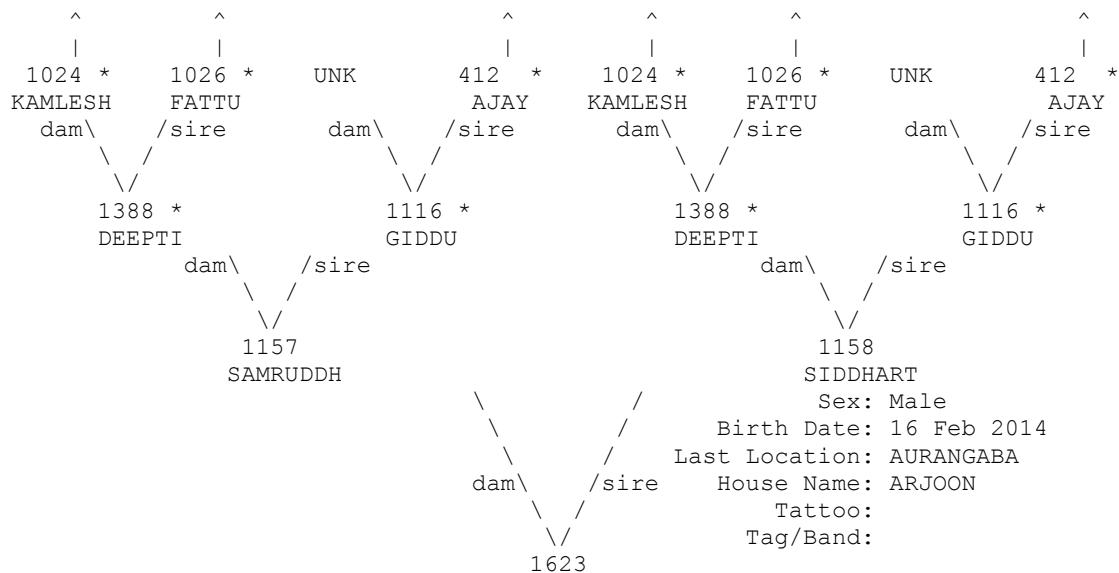

* Appear more than once...
 ^ Pedigree continues beyond top of page...

=====
 Taxon Name: PANTHERA TIGRIS Studbook Number: 1626
 =====

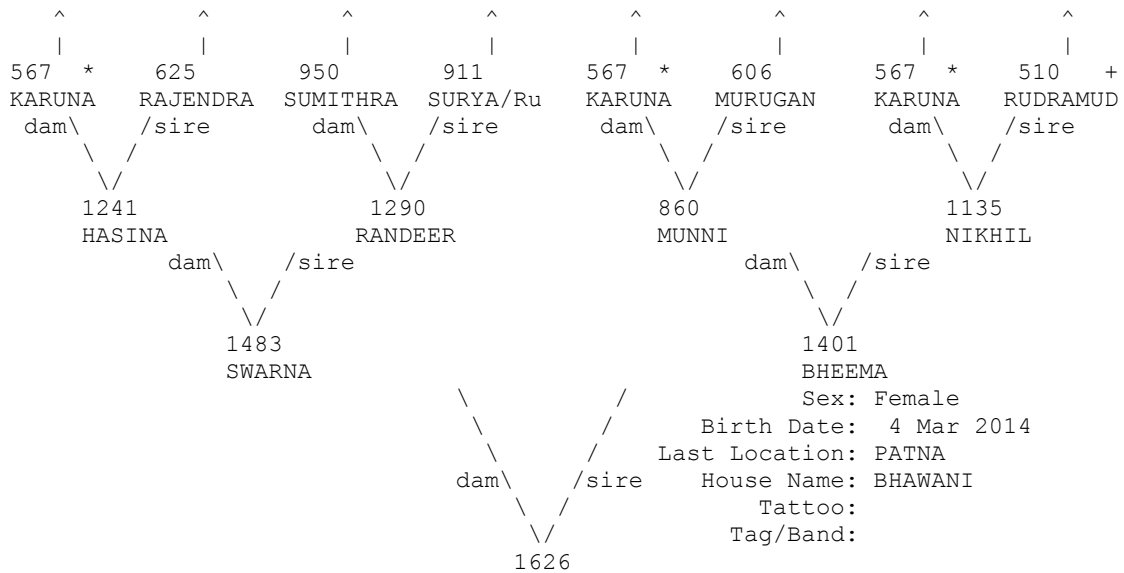

+ Wild-caught... * Appear more than once...
 ^ Pedigree continues beyond top of page...

=====
 Taxon Name: PANTHERA TIGRIS Studbook Number: 1627
 =====

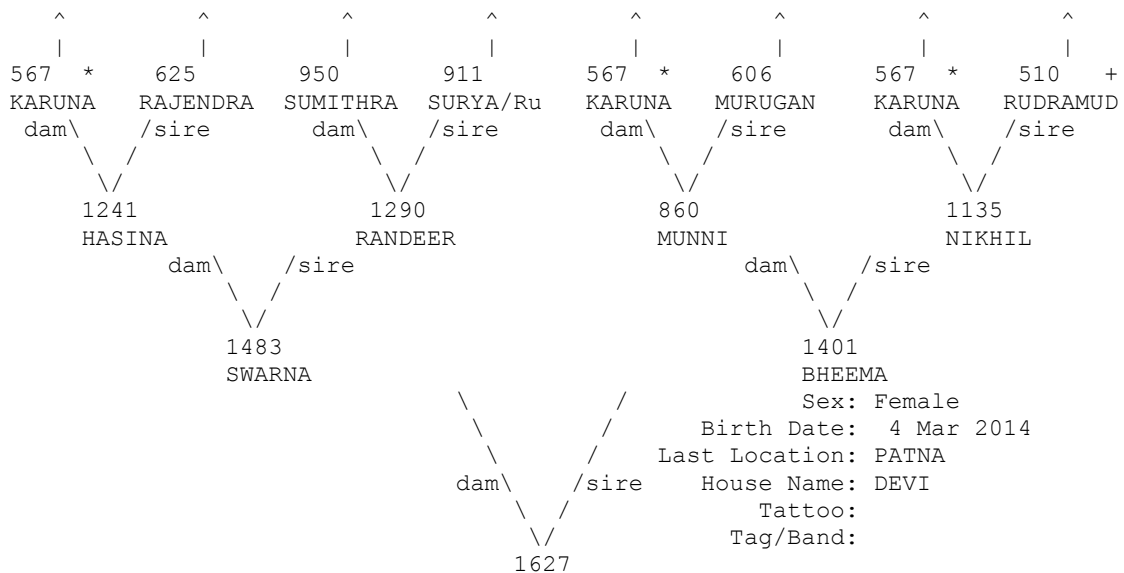

+ Wild-caught... * Appear more than once...
 ^ Pedigree continues beyond top of page...

=====
 Taxon Name: PANTHERA TIGRIS Studbook Number: 1629
 =====

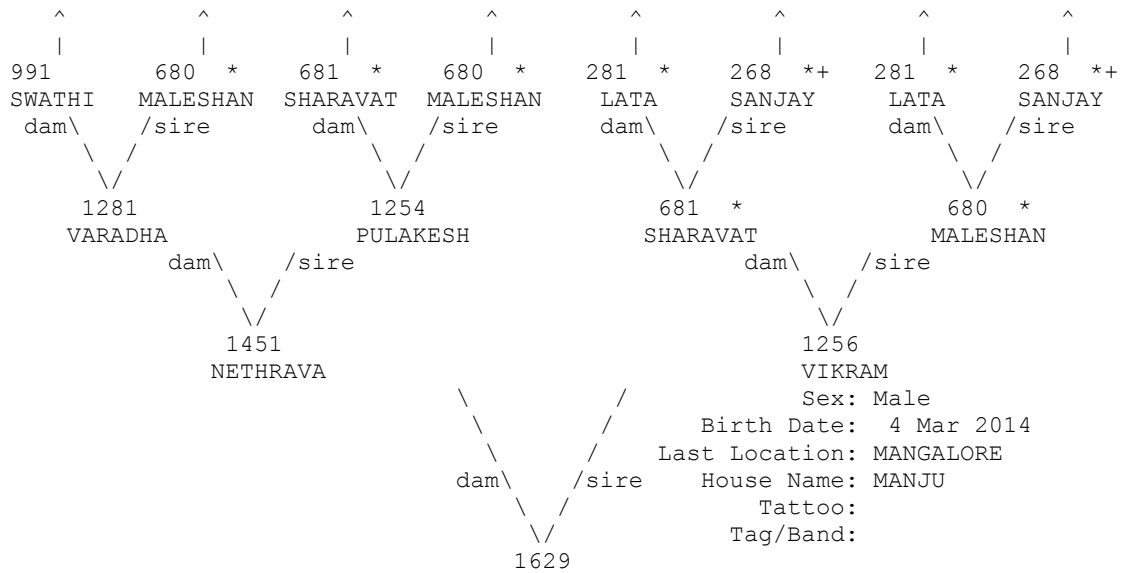

+ Wild-caught... * Appear more than once...
 ^ Pedigree continues beyond top of page...

=====
 Taxon Name: PANTHERA TIGRIS Studbook Number: 1630
 =====

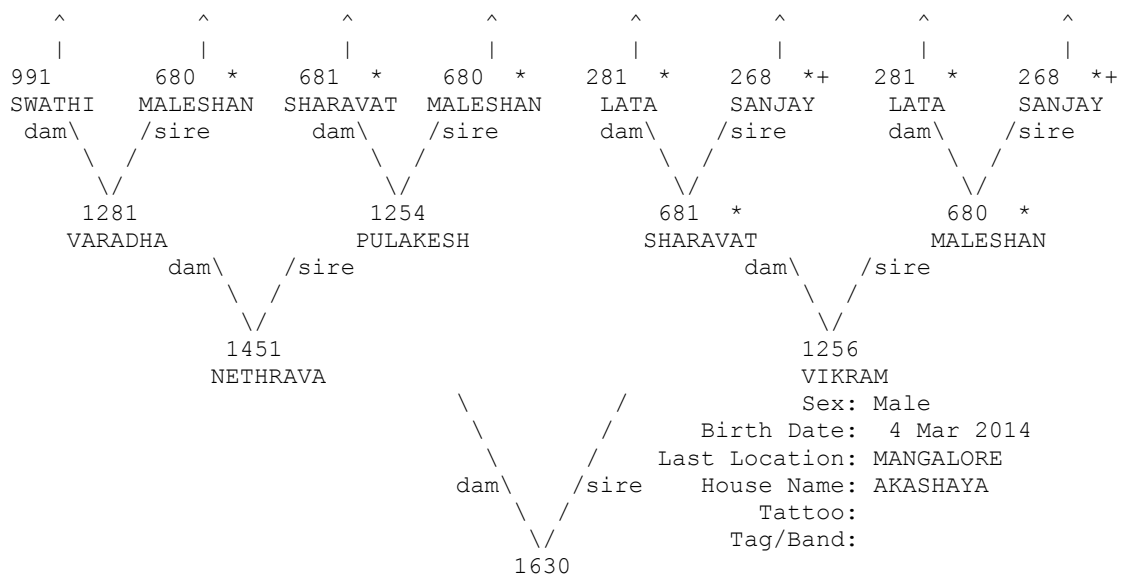

+ Wild-caught... * Appear more than once...
 ^ Pedigree continues beyond top of page...

=====
 Taxon Name: PANTHERA TIGRIS Studbook Number: 1631
 =====

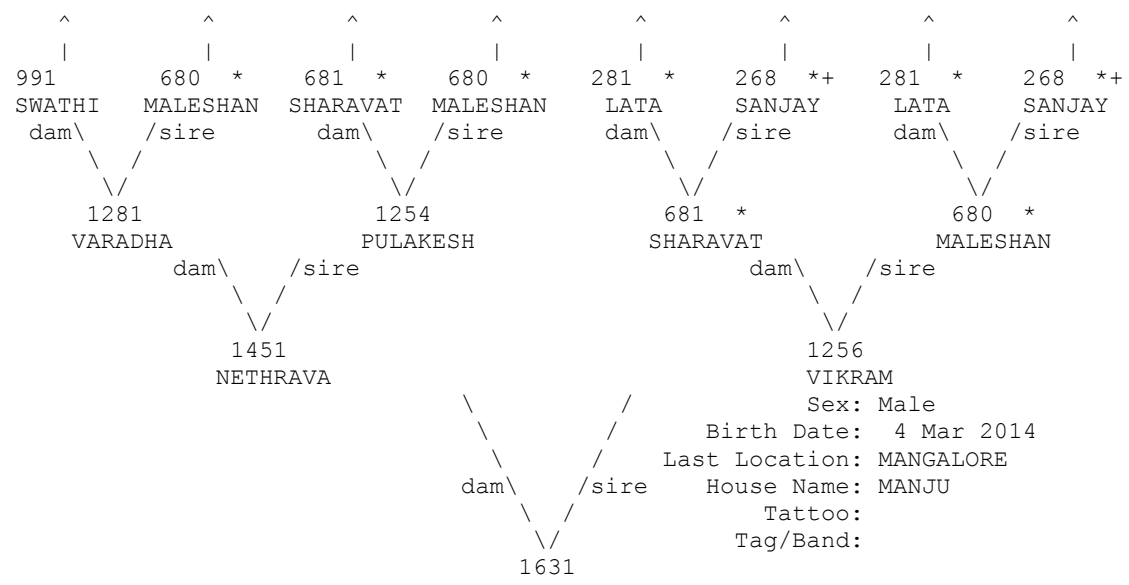

+ Wild-caught... * Appear more than once...
 ^ Pedigree continues beyond top of page...

=====
 Taxon Name: PANTHERA TIGRIS Studbook Number: 1632
 =====

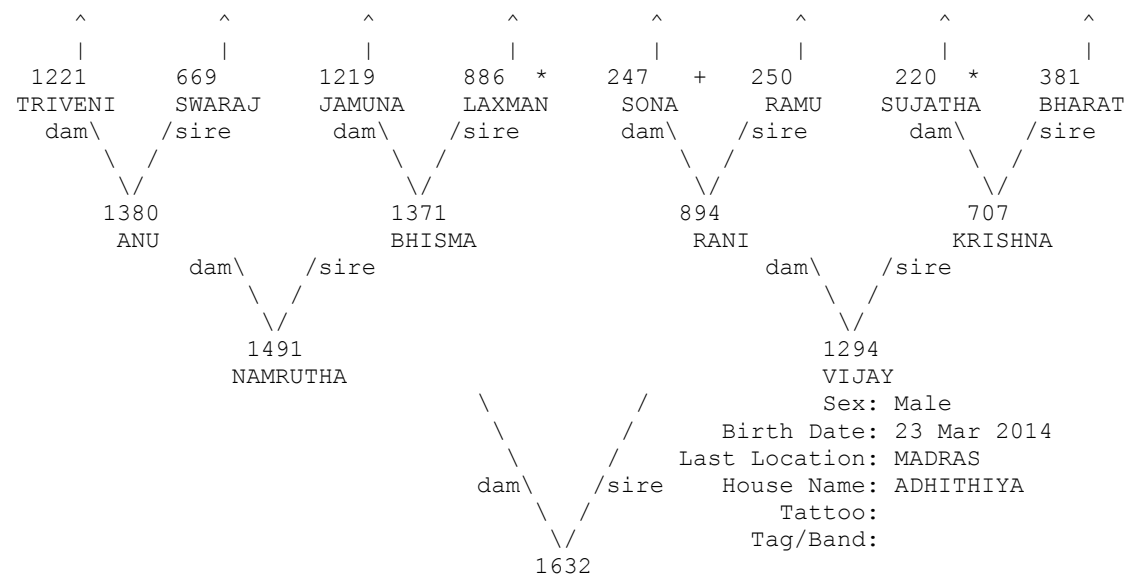

+ Wild-caught... * Appear more than once...
 ^ Pedigree continues beyond top of page...

=====
 Taxon Name: PANTHERA TIGRIS Studbook Number: 1633
 =====

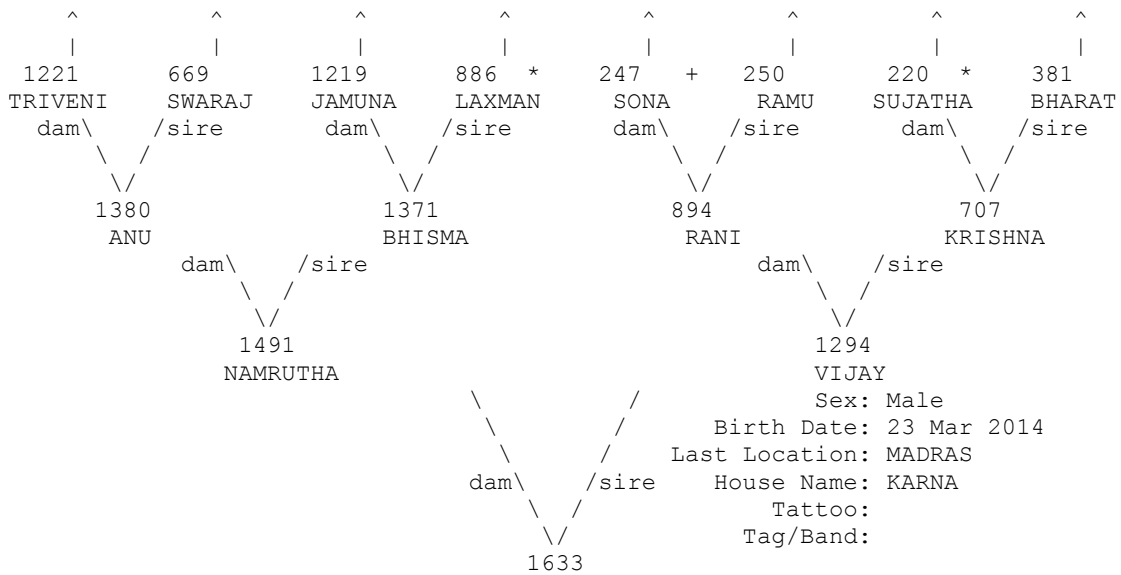

+ Wild-caught... * Appear more than once...
 ^ Pedigree continues beyond top of page...

=====
 Taxon Name: PANTHERA TIGRIS Studbook Number: 1634
 =====

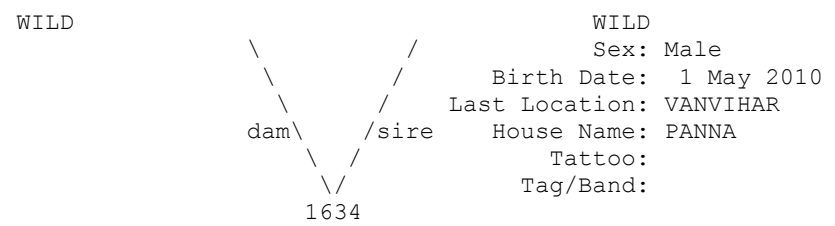

=====
 Taxon Name: PANTHERA TIGRIS Studbook Number: 1635
 =====

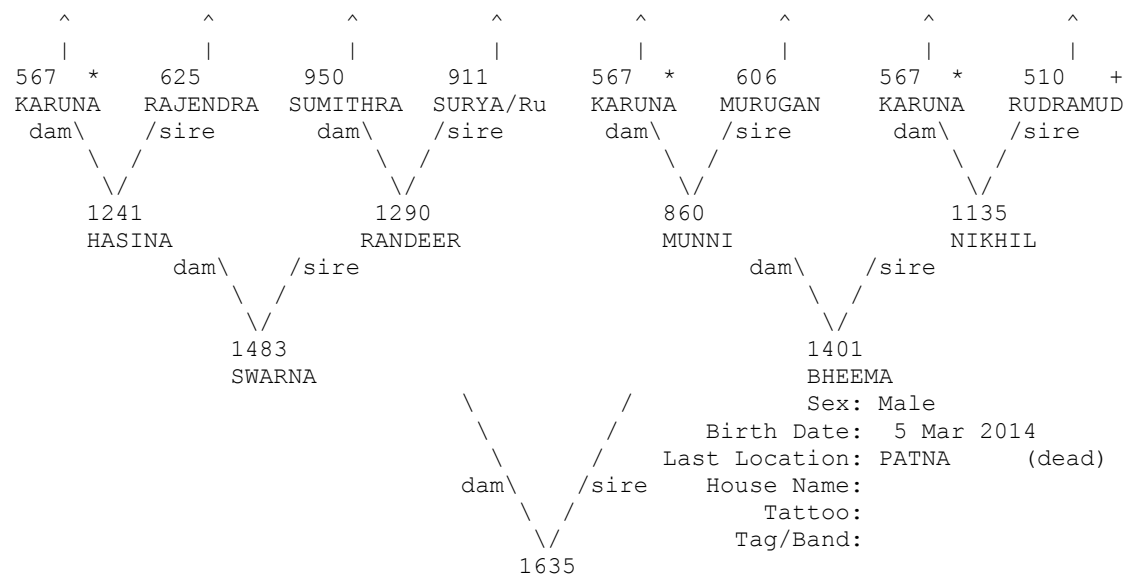

+ Wild-caught... * Appear more than once...
 ^ Pedigree continues beyond top of page...

=====
 Taxon Name: PANTHERA TIGRIS Studbook Number: 1638
 =====

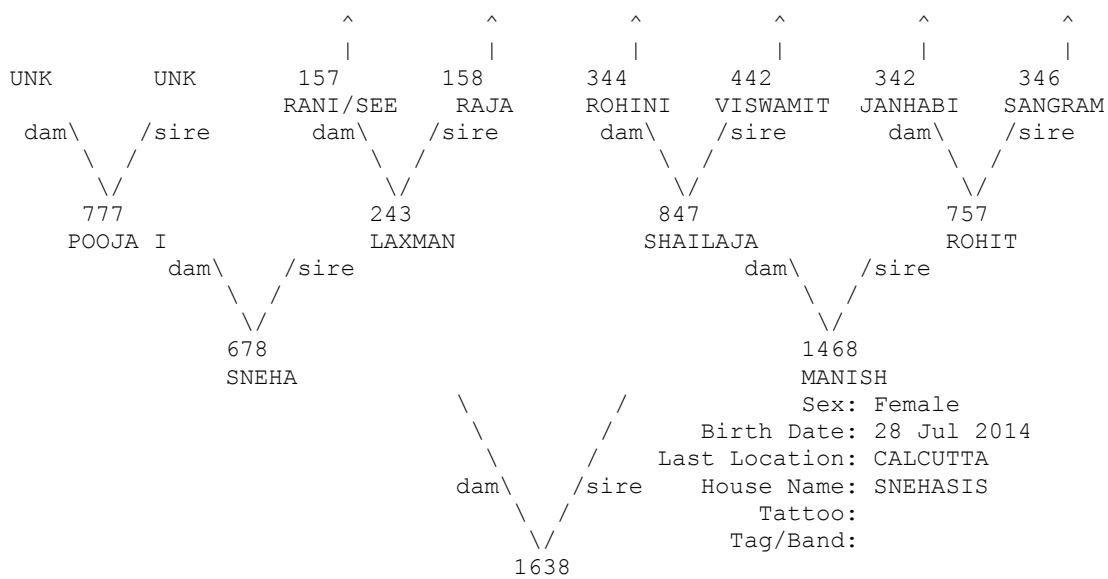

* Appear more than once...
 ^ Pedigree continues beyond top of page...

=====
 Taxon Name: PANTHERA TIGRIS Studbook Number: 1639
 =====

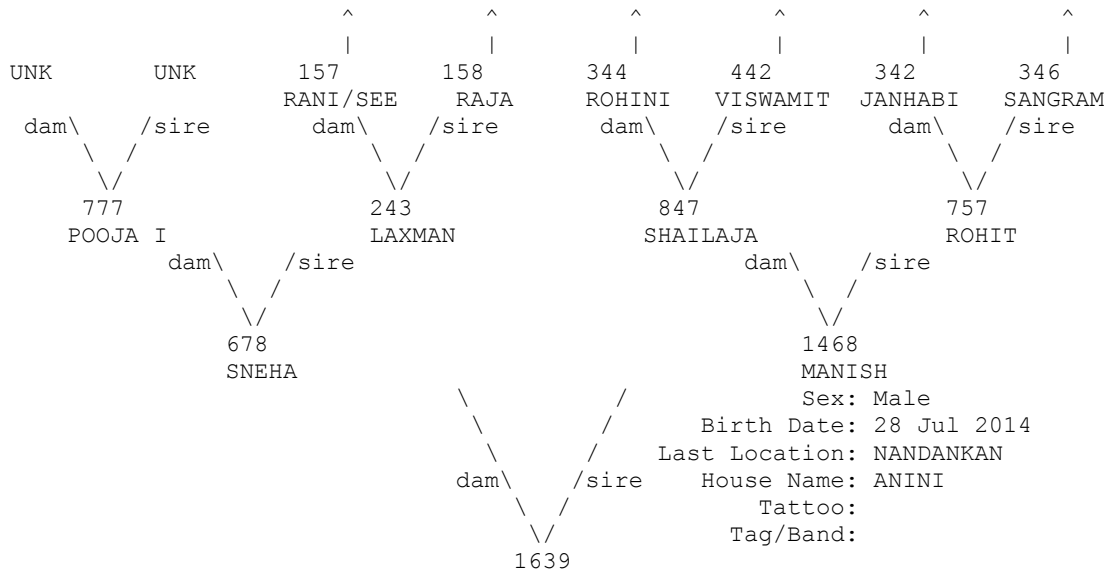

* Appear more than once...
 ^ Pedigree continues beyond top of page...

=====
 Taxon Name: PANTHERA TIGRIS Studbook Number: 1640
 =====

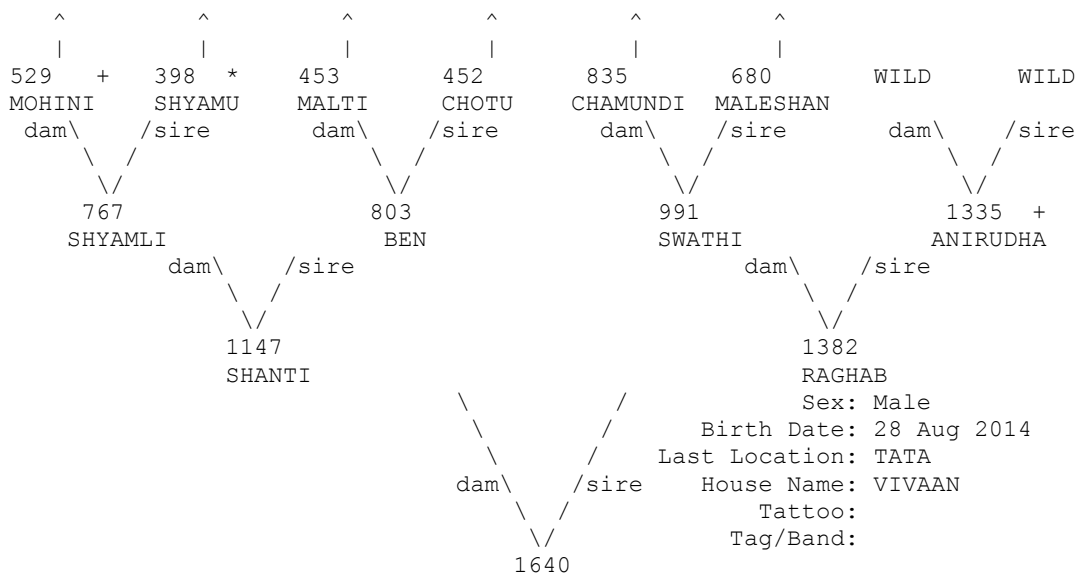

+ Wild-caught... * Appear more than once...
 ^ Pedigree continues beyond top of page...

=====
 Taxon Name: PANTHERA TIGRIS Studbook Number: 1641
 =====

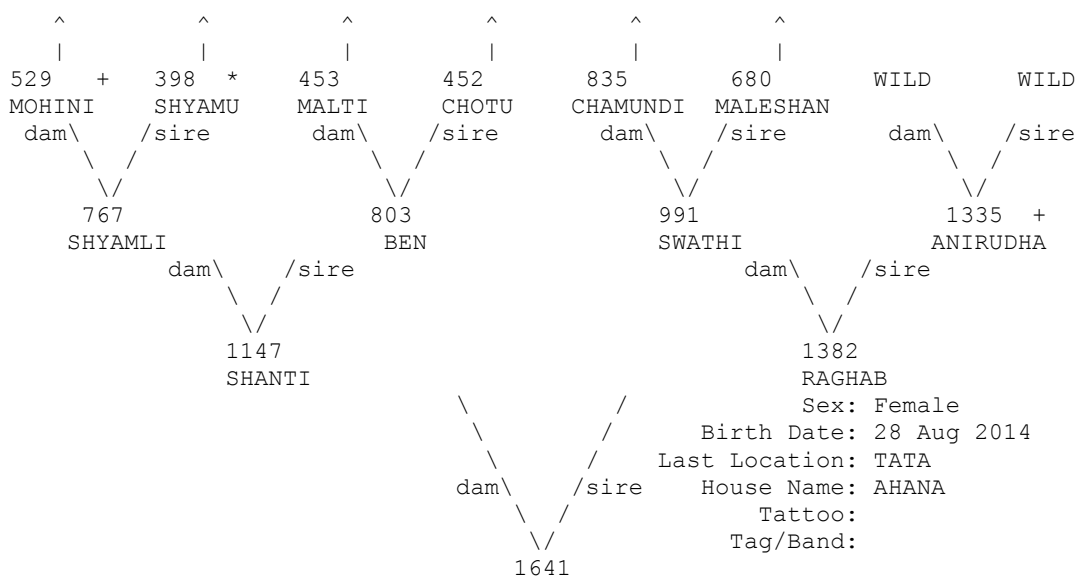

+ Wild-caught... * Appear more than once...
 ^ Pedigree continues beyond top of page...

=====
 Taxon Name: PANTHERA TIGRIS Studbook Number: 1645
 =====

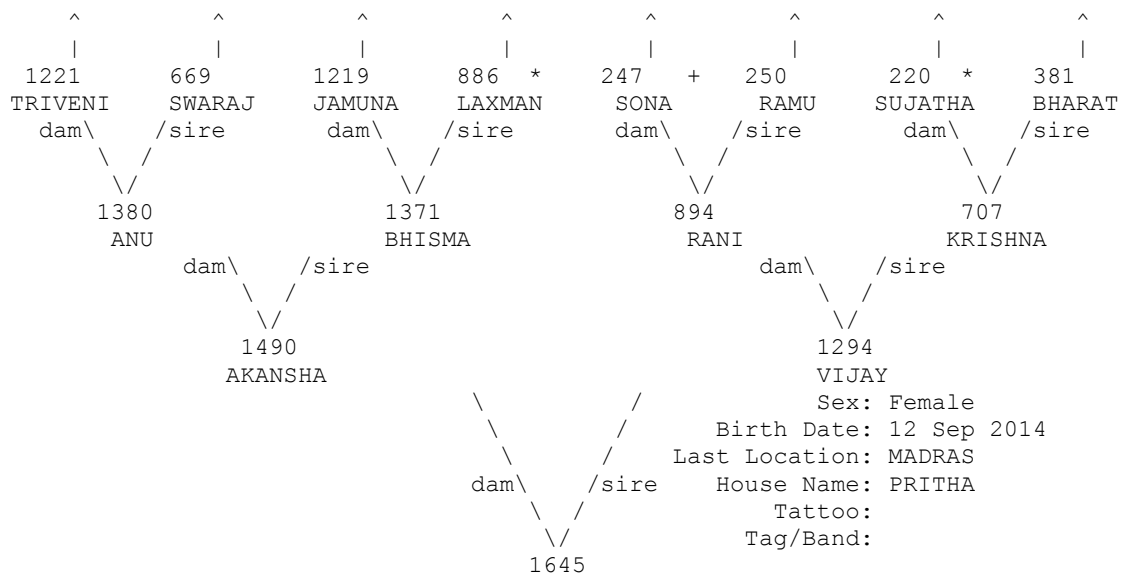

+ Wild-caught... * Appear more than once...
 ^ Pedigree continues beyond top of page...

=====
 Taxon Name: PANTHERA TIGRIS Studbook Number: 1646
 =====

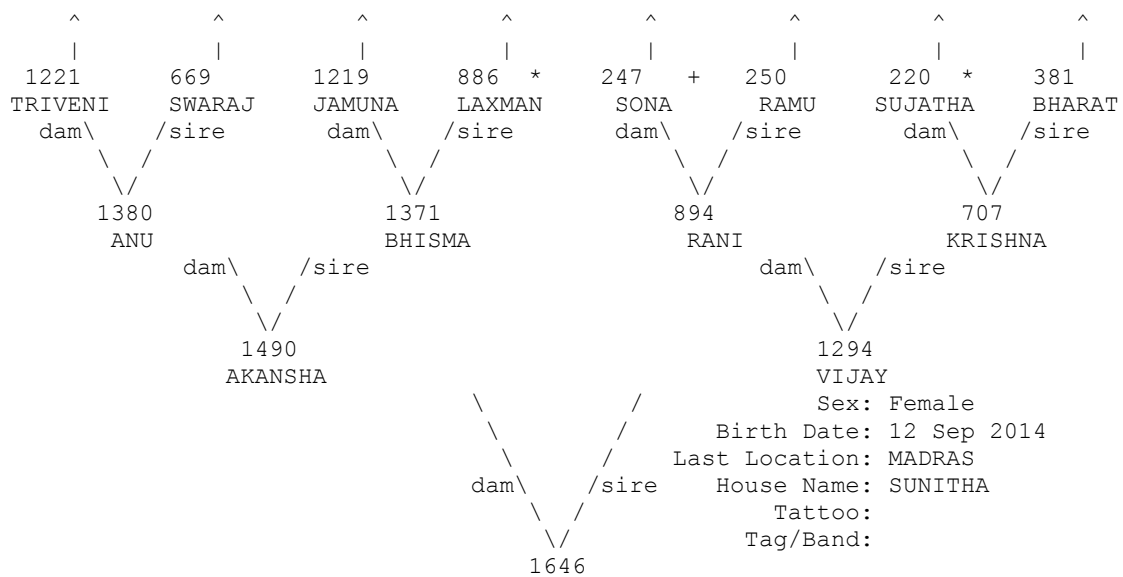

+ Wild-caught... * Appear more than once...
 ^ Pedigree continues beyond top of page...

=====
 Taxon Name: PANTHERA TIGRIS Studbook Number: 1647
 =====

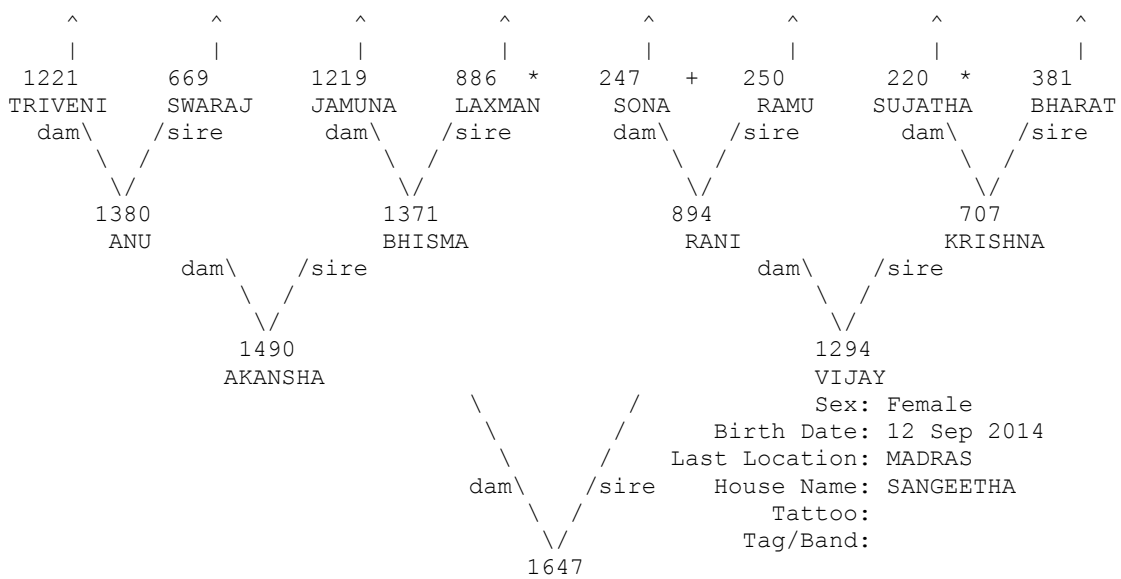

+ Wild-caught... * Appear more than once...
 ^ Pedigree continues beyond top of page...

=====
 Taxon Name: PANTHERA TIGRIS Studbook Number: 1649
 =====

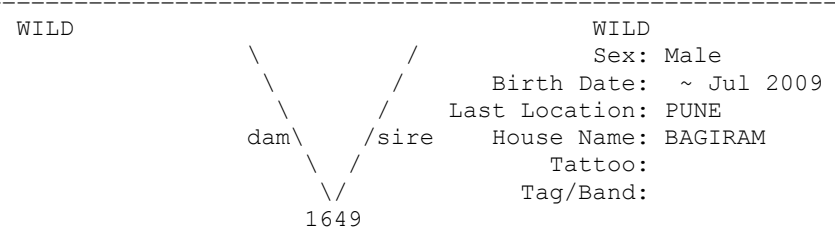

=====
 Taxon Name: PANTHERA TIGRIS Studbook Number: 1650
 =====

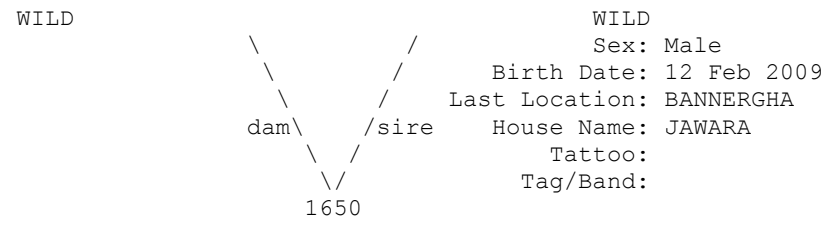

=====
Taxon Name: PANTHERA TIGRIS Studbook Number: 1654
=====

UNK UNK
dam\ /sire
UNK 1618 +
B1
Sex: Male
Birth Date: 9 Jan 2015
Last Location: INDORE
House Name: BAALI
Tattoo:
Tag/Band:
dam\ /sire
1654

+ Wild-caught...

=====
Taxon Name: PANTHERA TIGRIS Studbook Number: 1655
=====

UNK WILD WILD
dam\ /sire
UNK 1700 +
Sex: Female
Birth Date: 9 Jan 2015
Last Location: VANVIHAR
House Name: GANGA
Tattoo:
Tag/Band:
dam\ /sire
1655

+ Wild-caught...

=====
Taxon Name: PANTHERA TIGRIS Studbook Number: 1656
=====

WILD WILD
dam\ /sire
WILD Sex: Male
Birth Date: ~ 2014
Last Location: MYSORE (dead)
House Name: DHANUSH
Tattoo:
Tag/Band:
1656

=====
 Taxon Name: PANTHERA TIGRIS Studbook Number: 1659
 =====

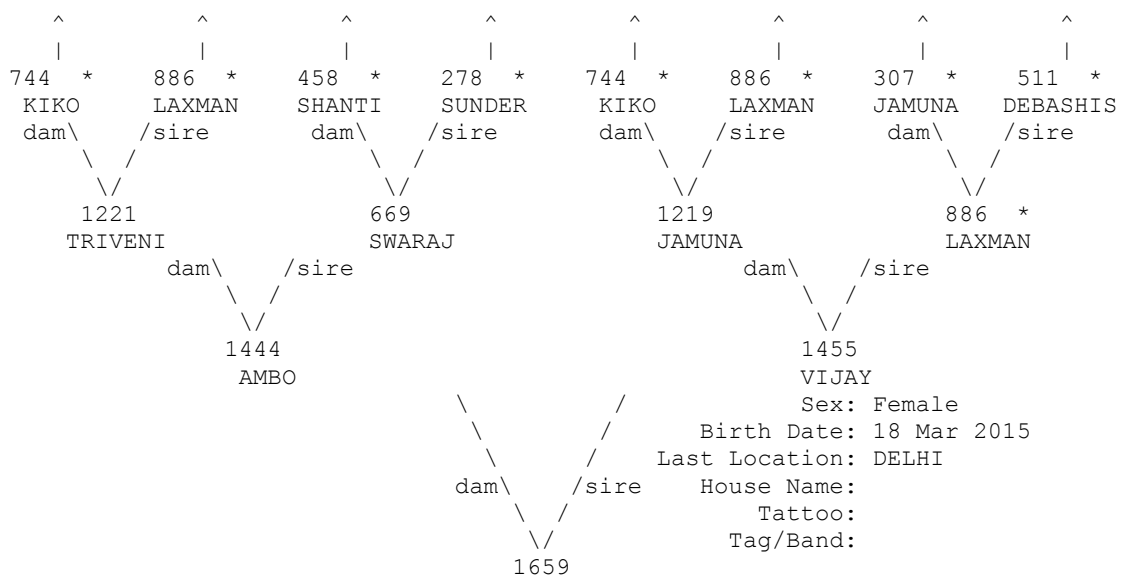

* Appear more than once...
 ^ Pedigree continues beyond top of page...

=====
 Taxon Name: PANTHERA TIGRIS Studbook Number: 1660
 =====

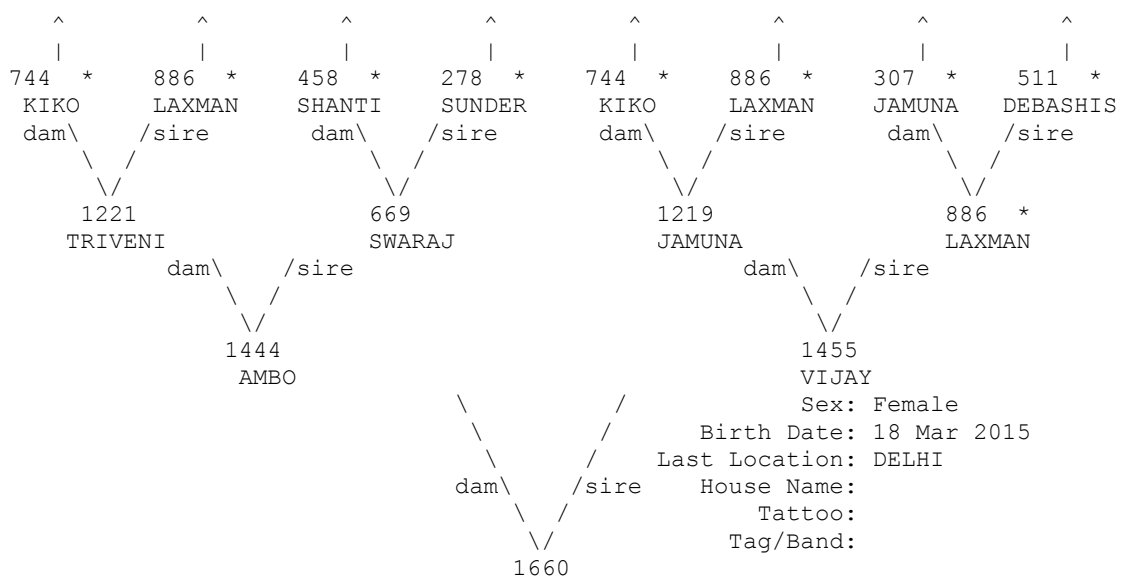

* Appear more than once...
 ^ Pedigree continues beyond top of page...

=====
 Taxon Name: PANTHERA TIGRIS Studbook Number: 1661
 =====

WILD

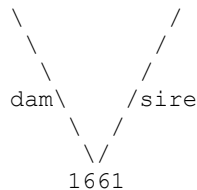

WILD
 Sex: Male
 Birth Date: ~ Mar 2012
 Last Location: MYSORE (dead)
 House Name: SANJAY
 Tattoo:
 Tag/Band:

=====
 Taxon Name: PANTHERA TIGRIS Studbook Number: 1662
 =====

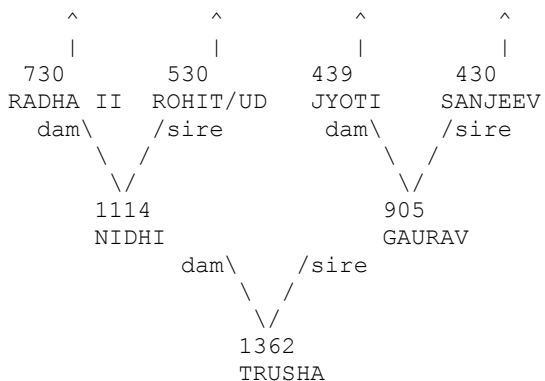

WILD WILD
 dam\ /sire
 \ /
 1516 +
 PRASHANT
 Sex: Male
 Birth Date: 5 May 2015
 Last Location: KANPUR
 House Name: BADAL
 Tattoo:
 Tag/Band:

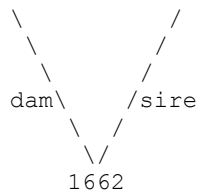

+ Wild-caught... * Appear more than once...
 ^ Pedigree continues beyond top of page...

=====
 Taxon Name: PANTHERA TIGRIS Studbook Number: 1663
 =====

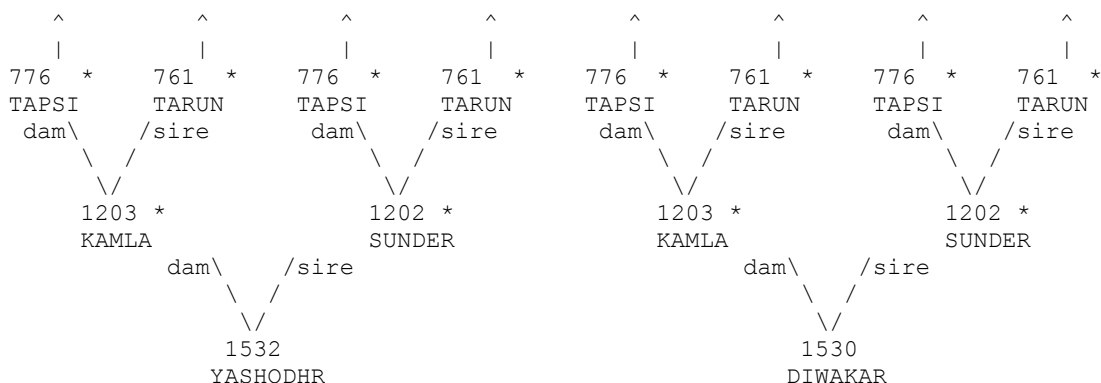

Sex: Female
 Birth Date: 6 May 2015
 Last Location: RAJKOT
 House Name:
 Tattoo:
 Tag/Band:

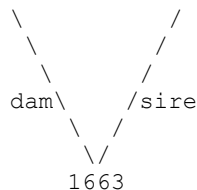

* Appear more than once...
 ^ Pedigree continues beyond top of page...

=====
 Taxon Name: PANTHERA TIGRIS Studbook Number: 1664
 =====

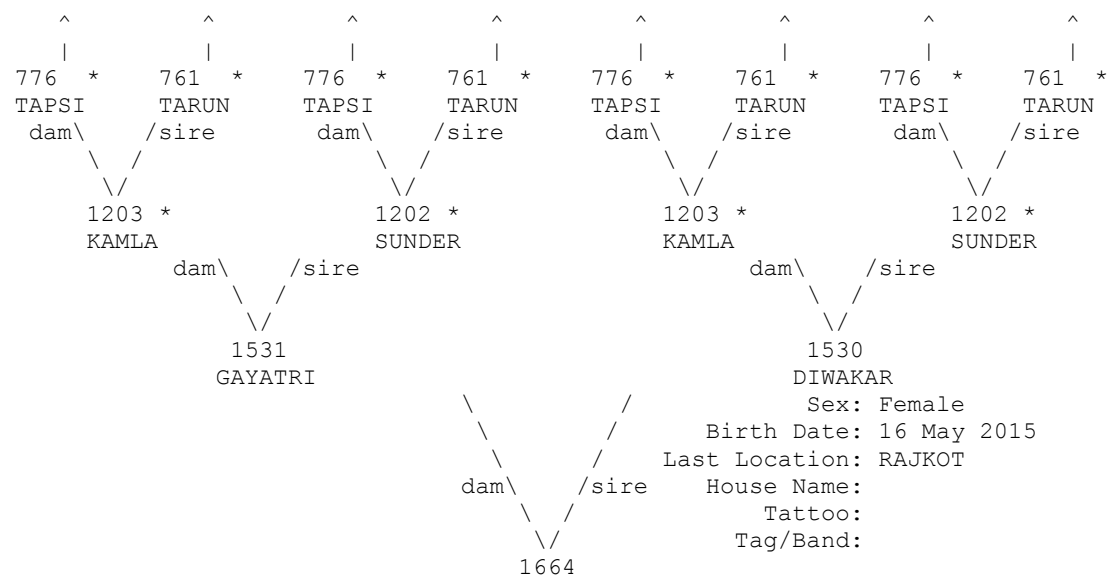

* Appear more than once...
 ^ Pedigree continues beyond top of page...

=====
 Taxon Name: PANTHERA TIGRIS Studbook Number: 1665
 =====

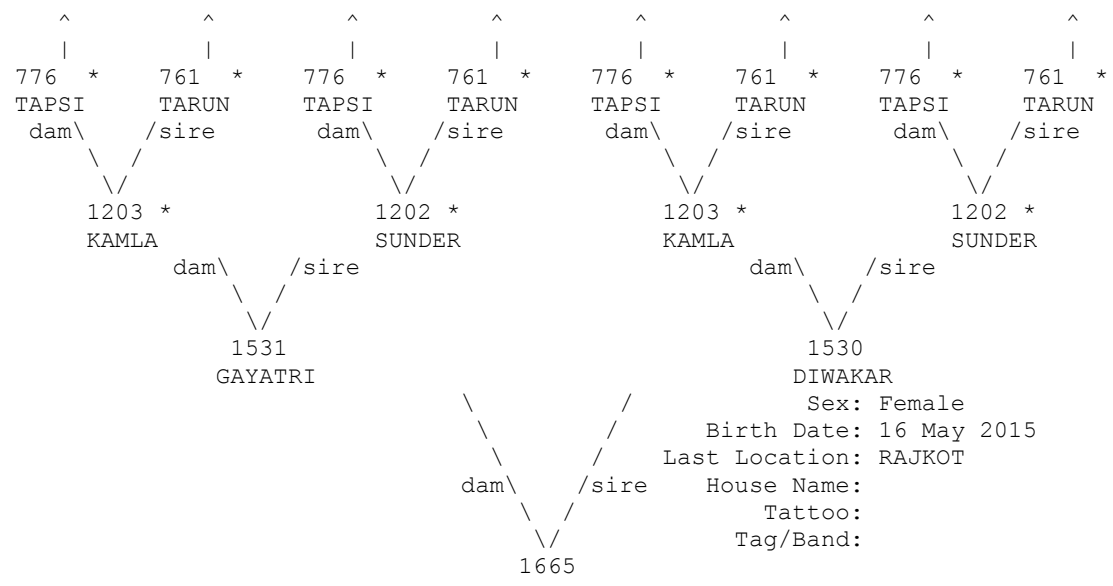

* Appear more than once...
 ^ Pedigree continues beyond top of page...

=====
 Taxon Name: PANTHERA TIGRIS Studbook Number: 1666
 =====

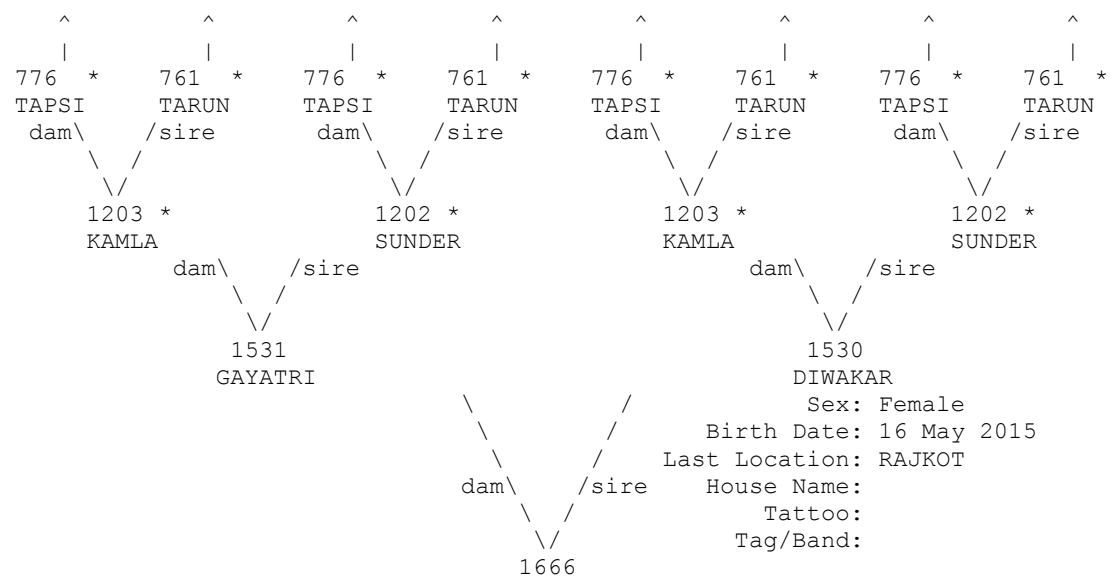

* Appear more than once...
 ^ Pedigree continues beyond top of page...

=====
 Taxon Name: PANTHERA TIGRIS Studbook Number: 1667
 =====

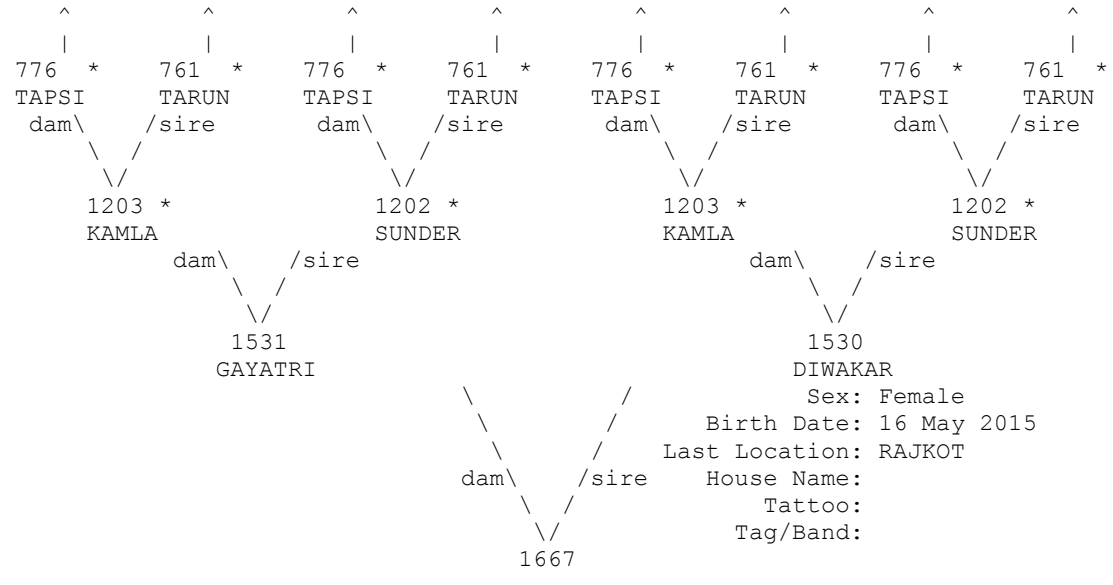

* Appear more than once...
 ^ Pedigree continues beyond top of page...

=====
 Taxon Name: PANTHERA TIGRIS Studbook Number: 1668
 =====

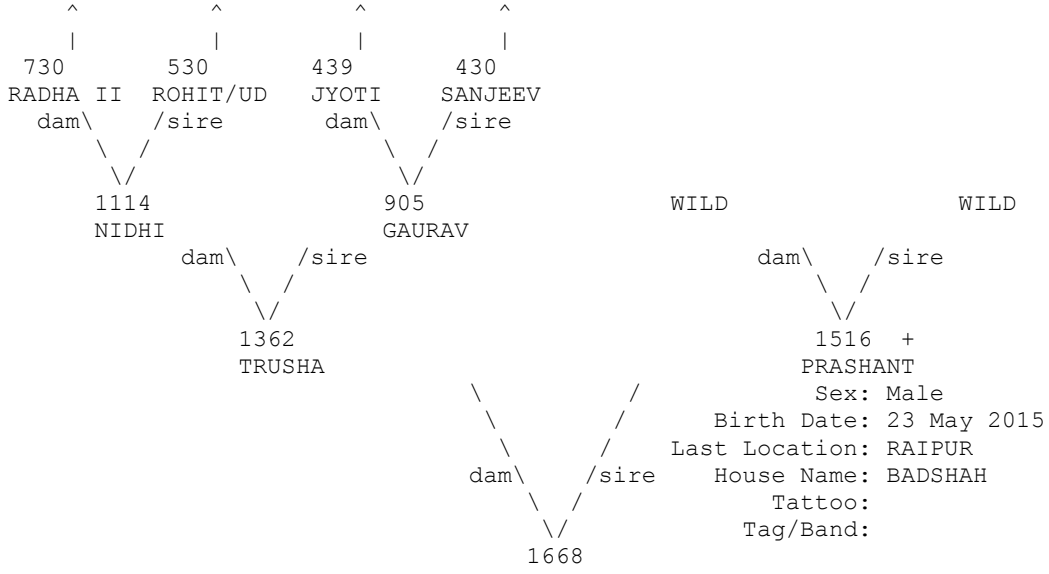

+ Wild-caught... * Appear more than once...
 ^ Pedigree continues beyond top of page...

=====
 Taxon Name: PANTHERA TIGRIS Studbook Number: 1669
 =====

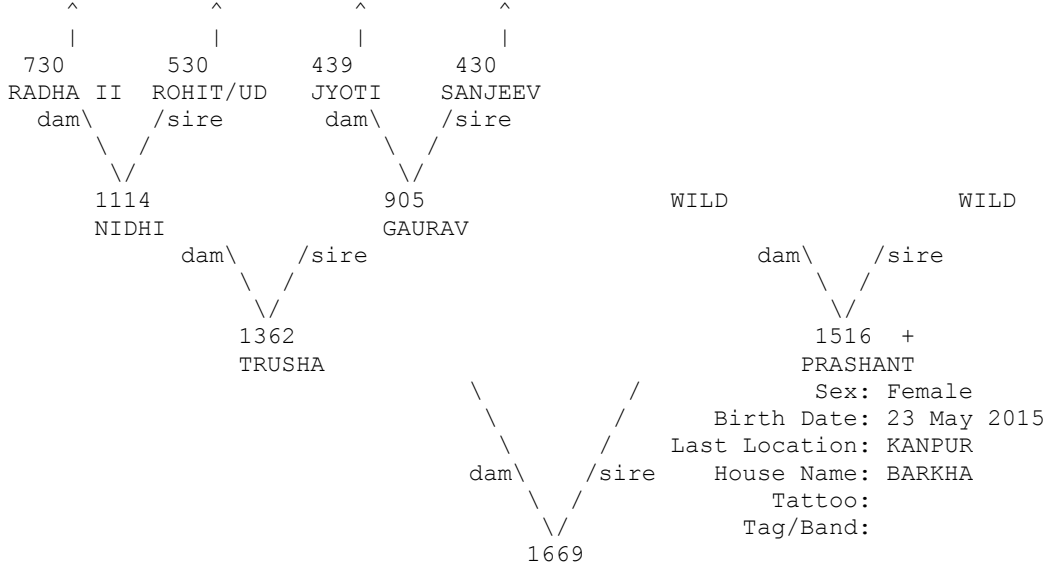

+ Wild-caught... * Appear more than once...
 ^ Pedigree continues beyond top of page...

=====
 Taxon Name: PANTHERA TIGRIS Studbook Number: 1670
 =====

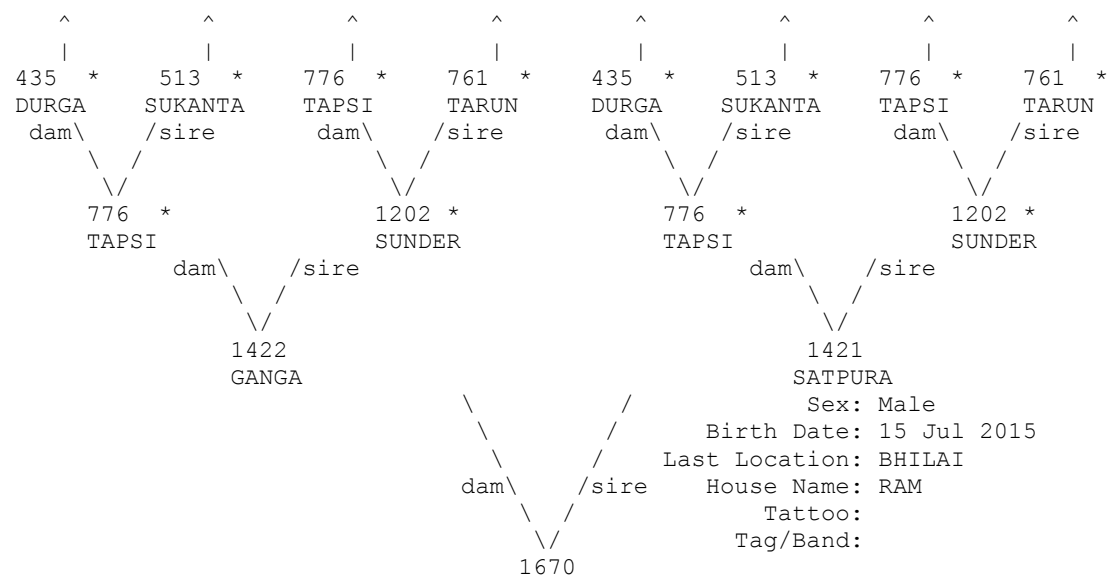

* Appear more than once...
 ^ Pedigree continues beyond top of page...

=====
 Taxon Name: PANTHERA TIGRIS Studbook Number: 1671
 =====

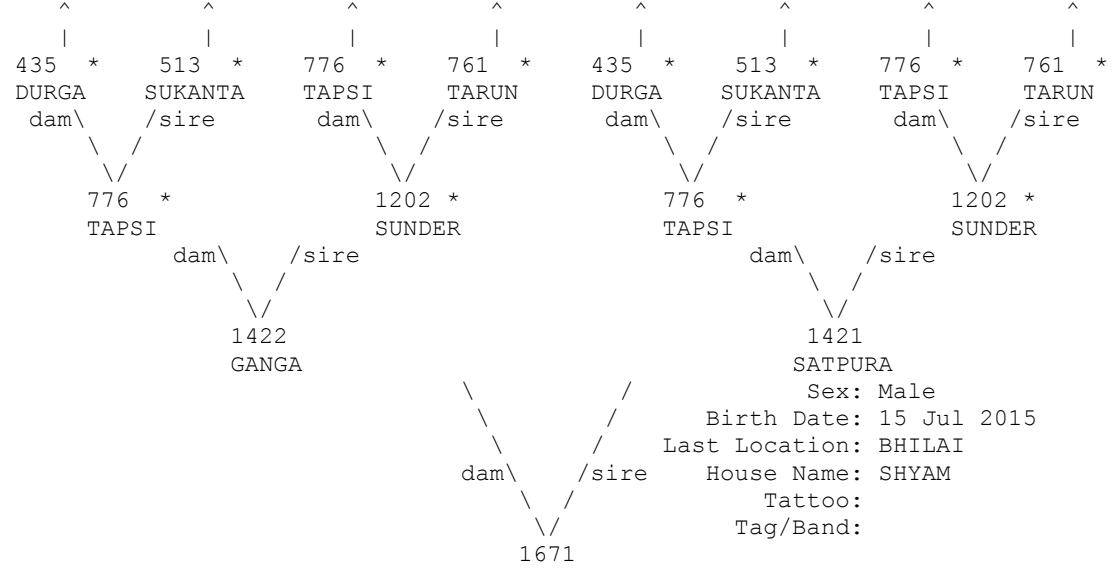

* Appear more than once...
 ^ Pedigree continues beyond top of page...

=====
 Taxon Name: PANTHERA TIGRIS Studbook Number: 1672
 =====

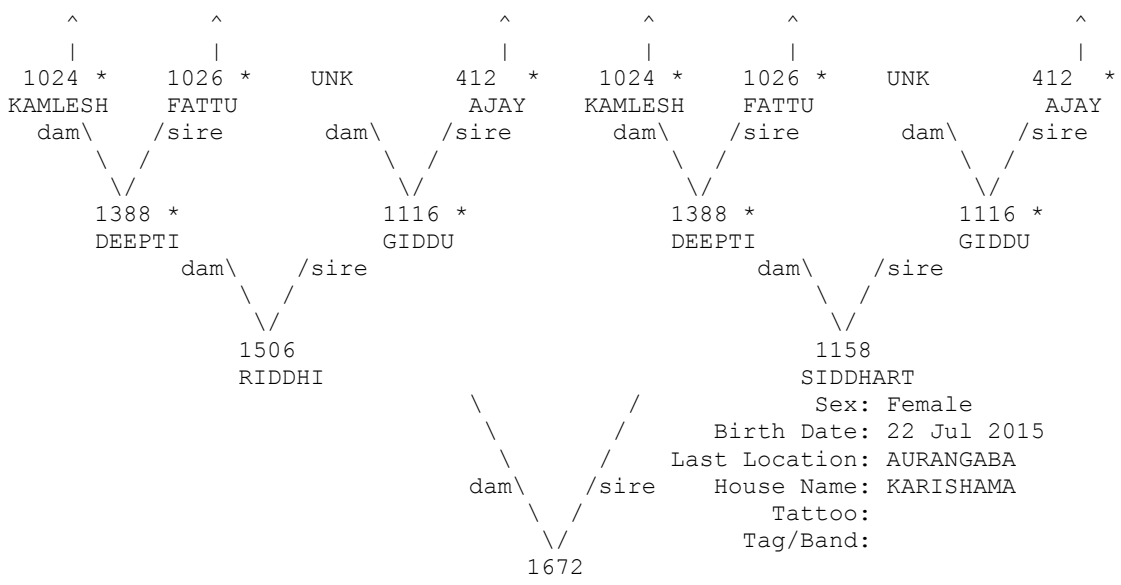

* Appear more than once...
 ^ Pedigree continues beyond top of page...

=====
 Taxon Name: PANTHERA TIGRIS Studbook Number: 1673
 =====

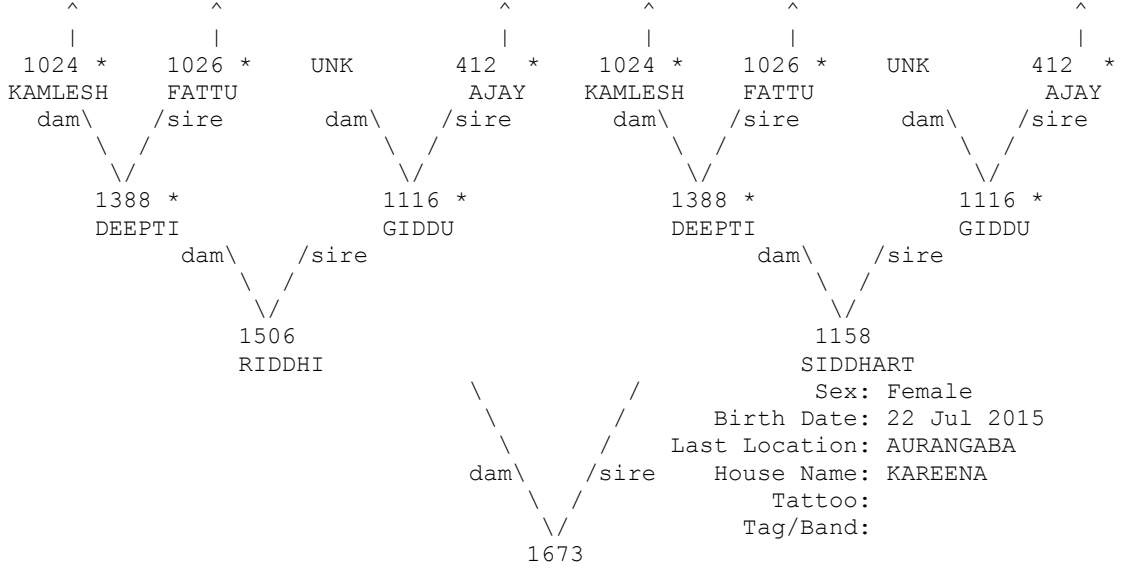

* Appear more than once...
 ^ Pedigree continues beyond top of page...

=====
 Taxon Name: PANTHERA TIGRIS Studbook Number: 1674
 =====

UNK

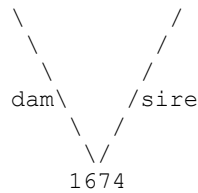

UNK
 Sex: Female
 Birth Date: 20 Aug 2015
 Last Location: VANVIHAR (dead)
 House Name:
 Tattoo:
 Tag/Band:

=====
 Taxon Name: PANTHERA TIGRIS Studbook Number: 1675
 =====

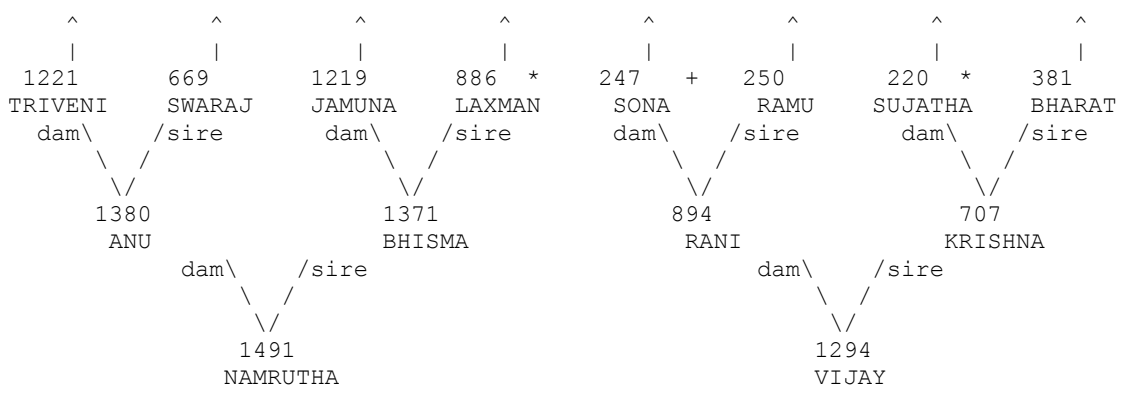

Sex: Male
 Birth Date: 16 Oct 2015
 Last Location: MADRAS
 House Name: NAGULA
 Tattoo:
 Tag/Band:

+ Wild-caught... * Appear more than once...
 ^ Pedigree continues beyond top of page...

=====
 Taxon Name: PANTHERA TIGRIS Studbook Number: 1676
 =====

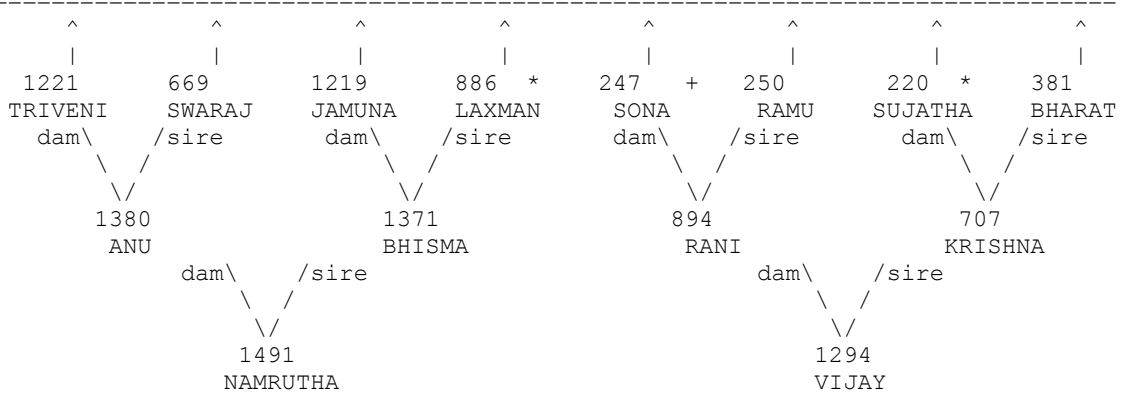

Sex: Female
 Birth Date: 16 Oct 2015
 Last Location: MADRAS
 House Name: KALAM
 Tattoo:
 Tag/Band:

+ Wild-caught... * Appear more than once...
 ^ Pedigree continues beyond top of page...

=====
 Taxon Name: PANTHERA TIGRIS Studbook Number: 1681
 =====

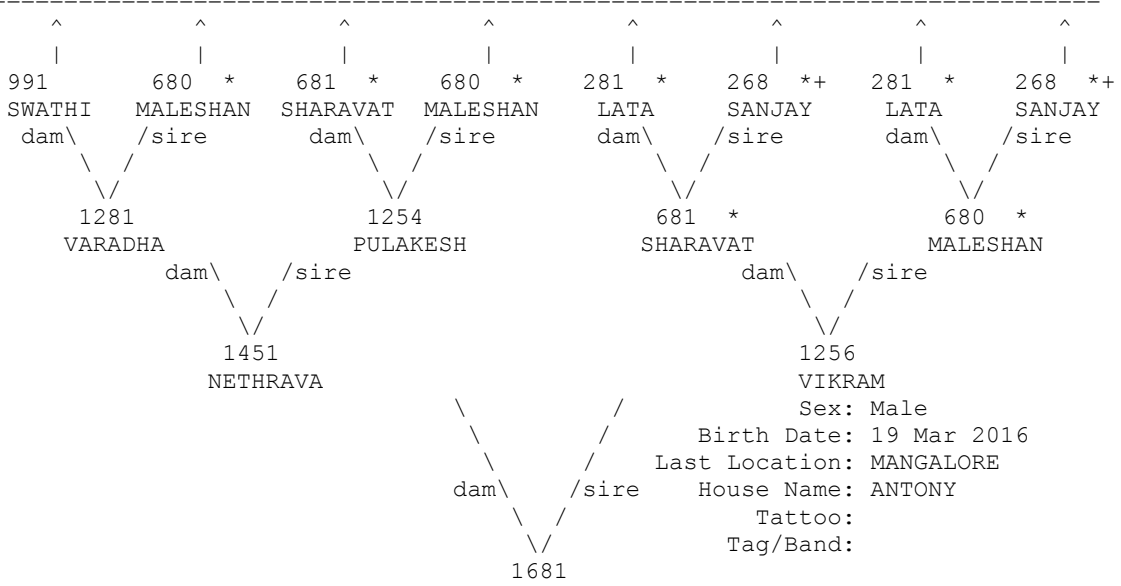

+ Wild-caught... * Appear more than once...
 ^ Pedigree continues beyond top of page...

=====
 Taxon Name: PANTHERA TIGRIS Studbook Number: 1682
 =====

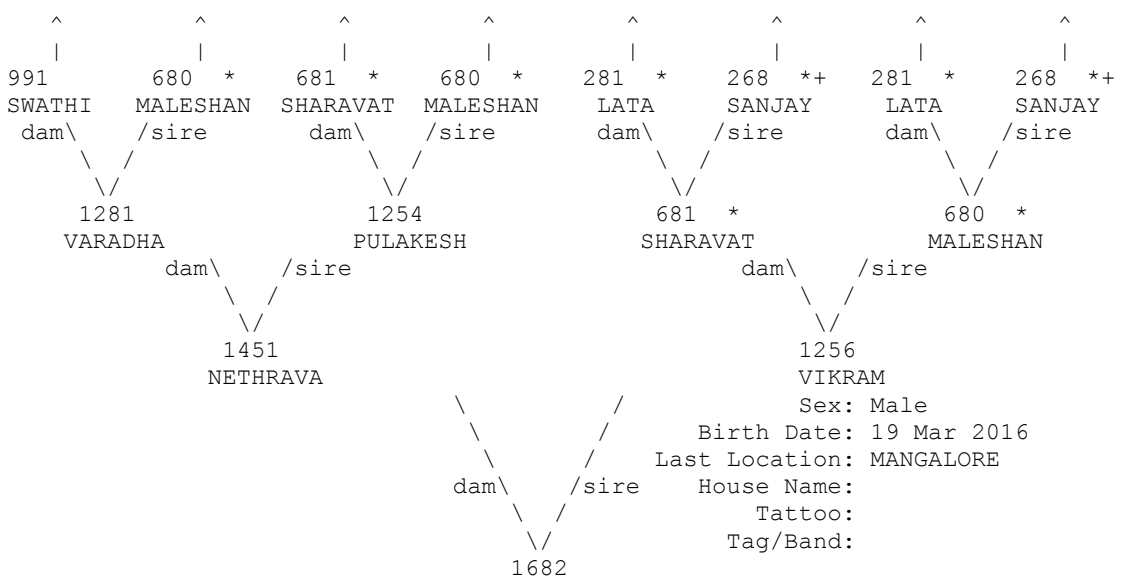

+ Wild-caught... * Appear more than once...
 ^ Pedigree continues beyond top of page...

=====
 Taxon Name: PANTHERA TIGRIS Studbook Number: 1683
 =====

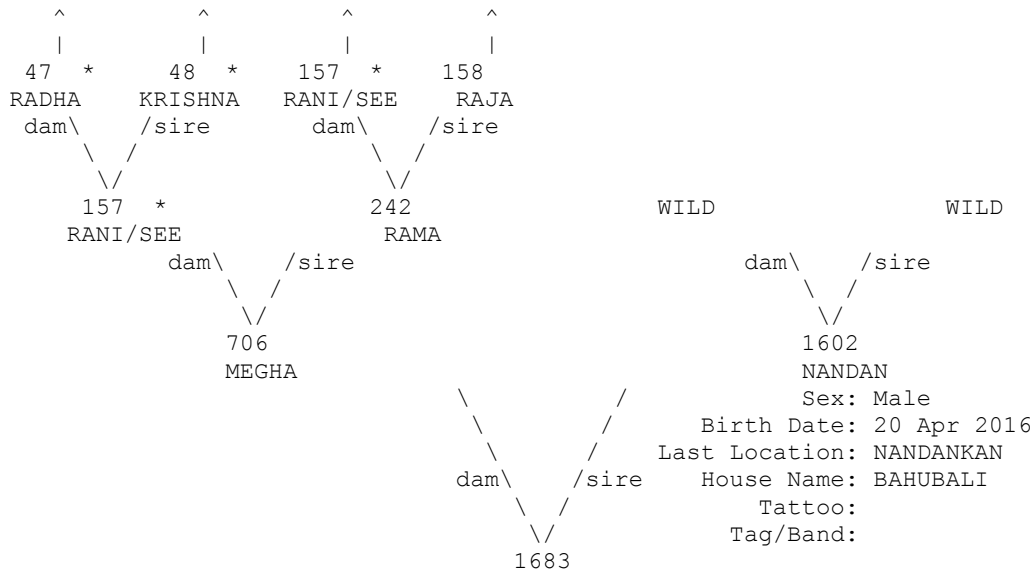

* Appear more than once...
 ^ Pedigree continues beyond top of page...

=====
 Taxon Name: PANTHERA TIGRIS Studbook Number: 1684
 =====

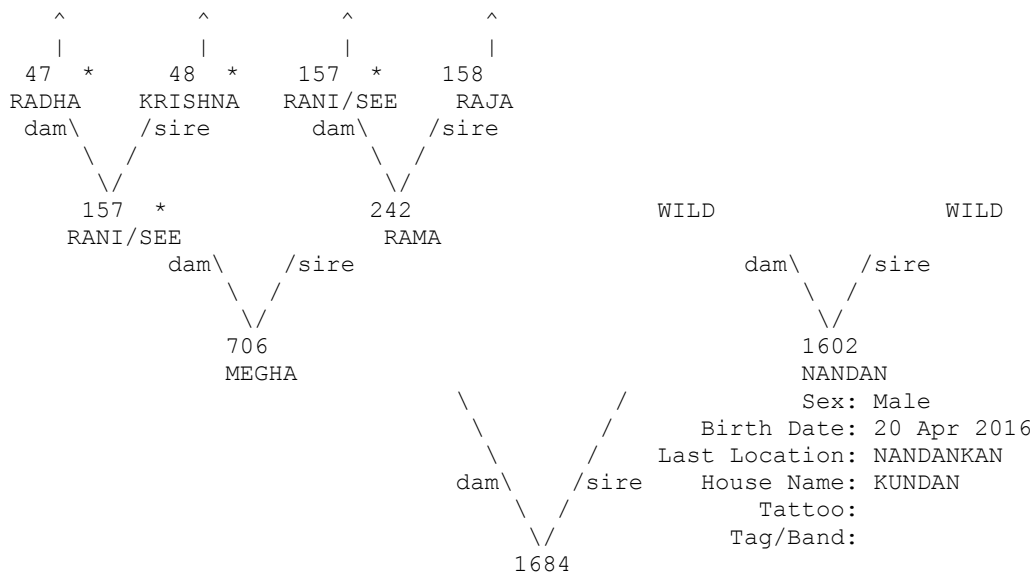

* Appear more than once...
 ^ Pedigree continues beyond top of page...

=====
 Taxon Name: PANTHERA TIGRIS Studbook Number: 1685
 =====

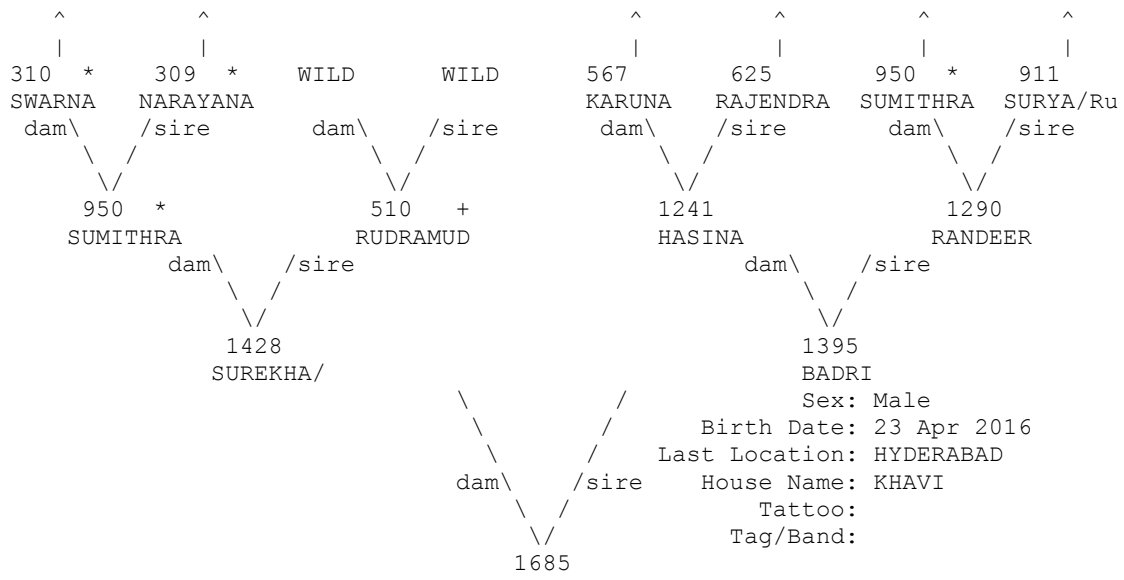

+ Wild-caught... * Appear more than once...
 ^ Pedigree continues beyond top of page...

=====
 Taxon Name: PANTHERA TIGRIS Studbook Number: 1686
 =====

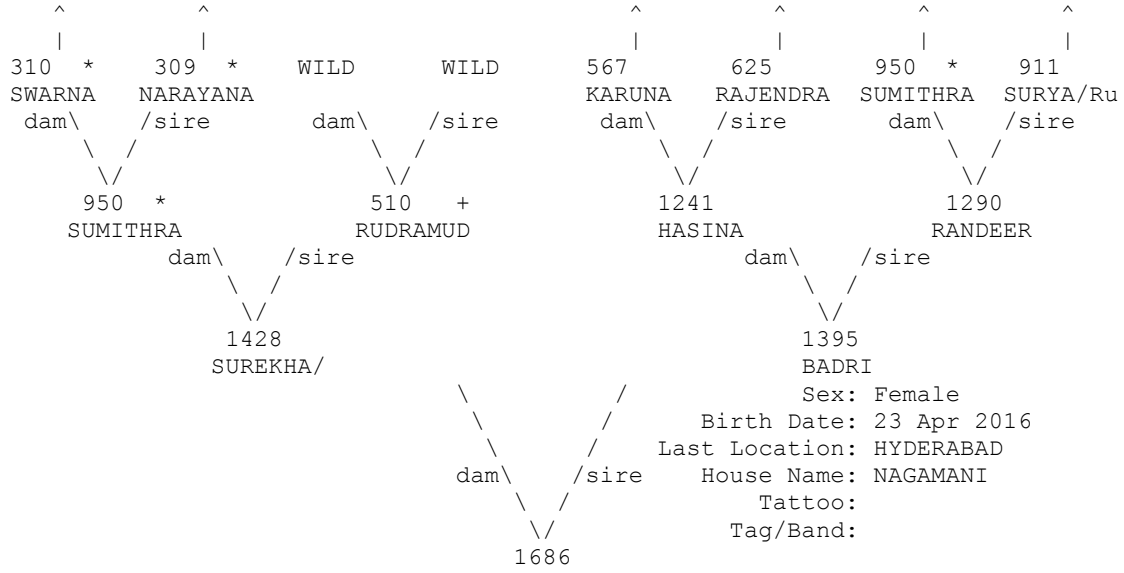

+ Wild-caught... * Appear more than once...
 ^ Pedigree continues beyond top of page...

=====
 Taxon Name: PANTHERA TIGRIS Studbook Number: 1690
 =====

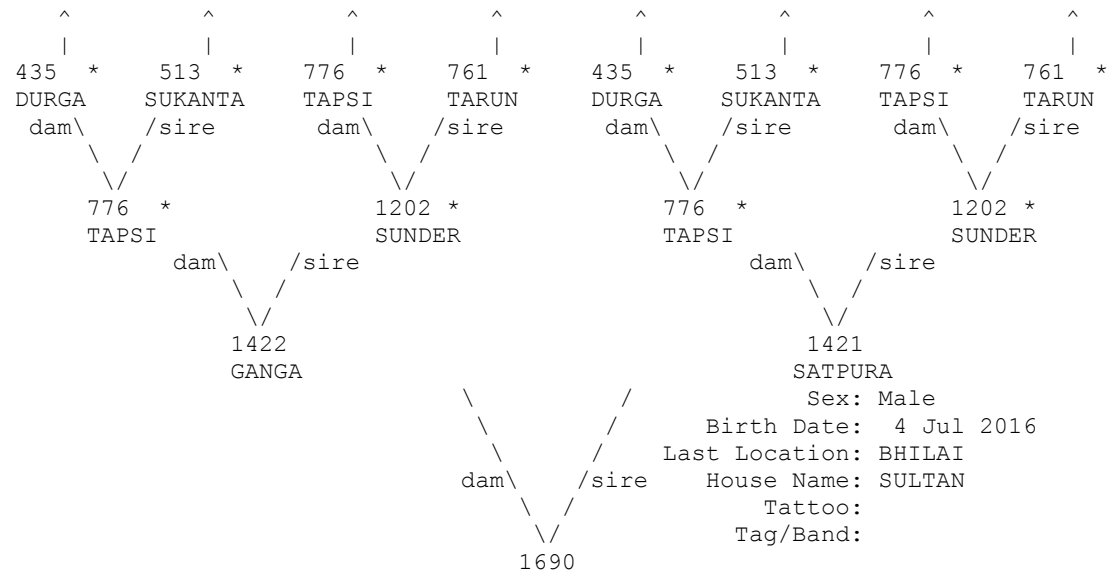

* Appear more than once...
 ^ Pedigree continues beyond top of page...

=====
 Taxon Name: PANTHERA TIGRIS Studbook Number: 1691
 =====

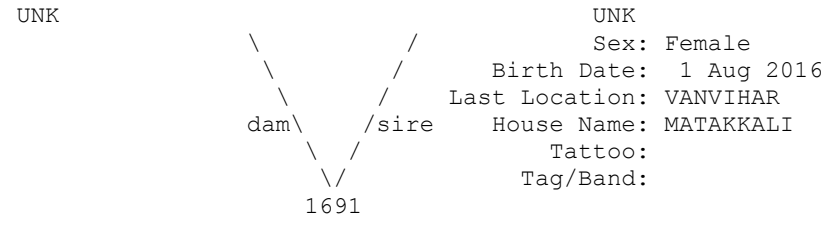

=====
 Taxon Name: PANTHERA TIGRIS Studbook Number: 1692
 =====

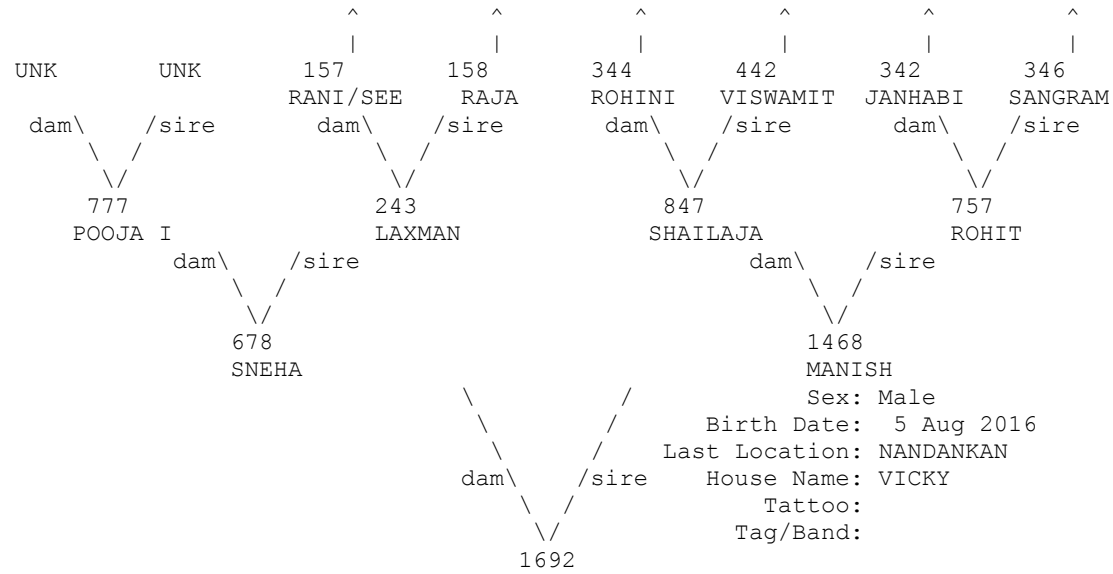

* Appear more than once...
 ^ Pedigree continues beyond top of page...

=====
 Taxon Name: PANTHERA TIGRIS Studbook Number: 1693
 =====

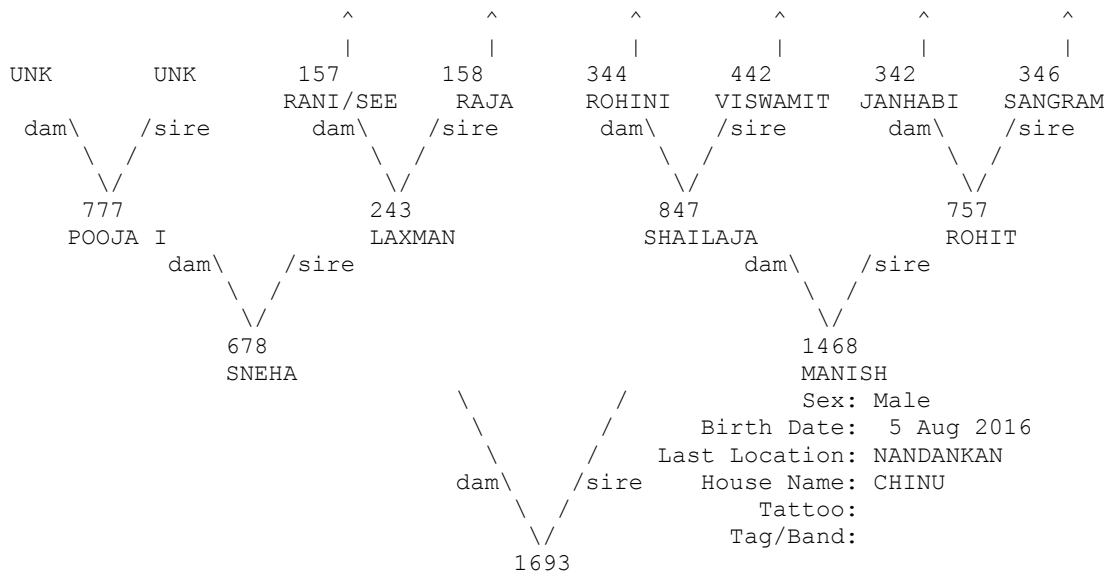

* Appear more than once...
 ^ Pedigree continues beyond top of page...

=====
 Taxon Name: PANTHERA TIGRIS Studbook Number: 1694
 =====

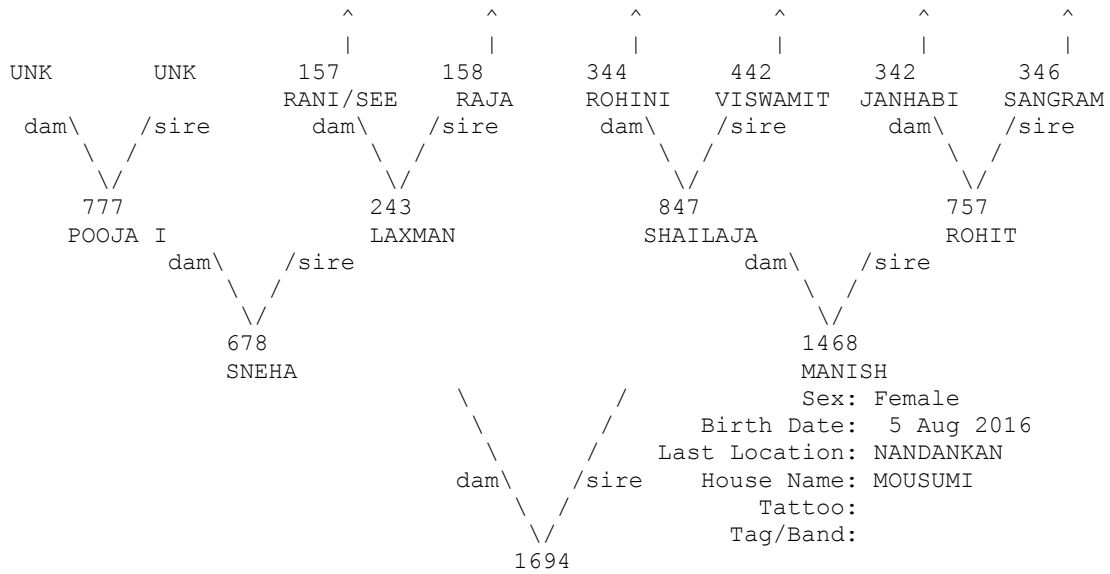

* Appear more than once...
 ^ Pedigree continues beyond top of page...

=====
 Taxon Name: PANTHERA TIGRIS Studbook Number: 1695
 =====

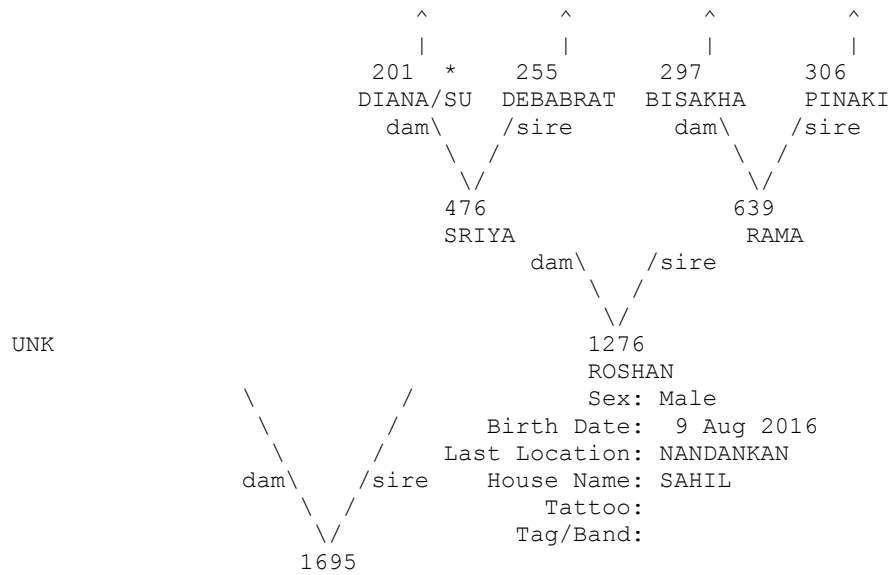

* Appear more than once...
 ^ Pedigree continues beyond top of page...

=====
 Taxon Name: PANTHERA TIGRIS Studbook Number: 1696
 =====

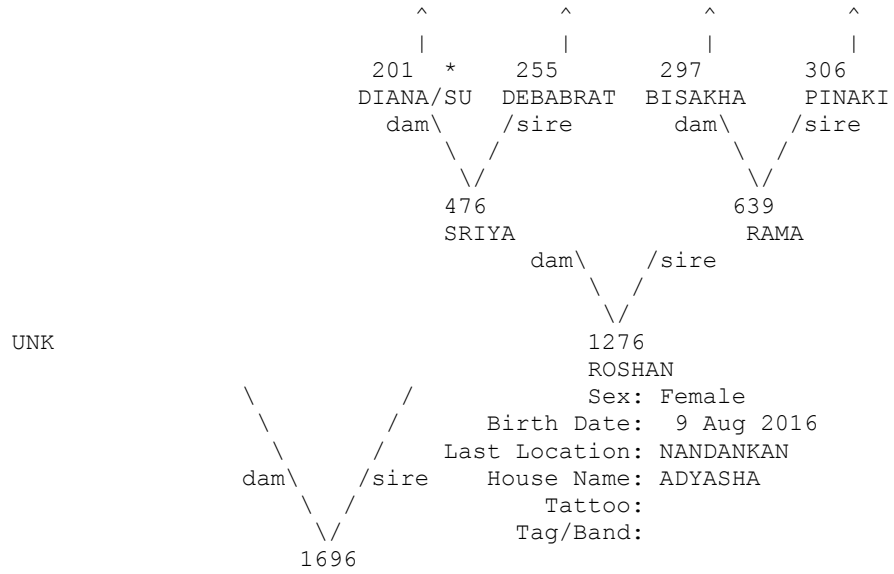

* Appear more than once...
 ^ Pedigree continues beyond top of page...

=====
 Taxon Name: PANTHERA TIGRIS Studbook Number: 1700
 =====

WILD

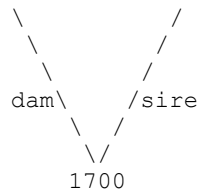

WILD
 Sex: Male
 Birth Date: ????
 Last Location: INDORE
 House Name:
 Tattoo:
 Tag/Band:

=====
 Taxon Name: PANTHERA TIGRIS Studbook Number: 1701
 =====

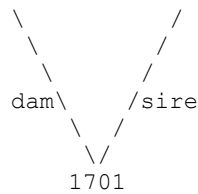
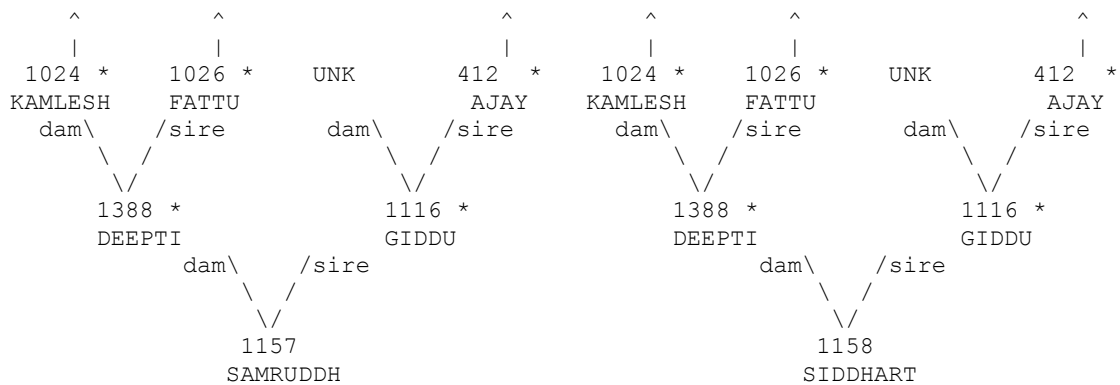

Sex: Male
 Birth Date: 12 Nov 2016
 Last Location: AURANGABA
 House Name: SHAKTI
 Tattoo:
 Tag/Band:

* Appear more than once...
 ^ Pedigree continues beyond top of page...

=====
 Taxon Name: PANTHERA TIGRIS Studbook Number: 1702
 =====

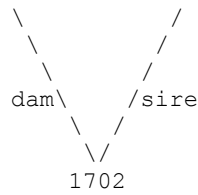
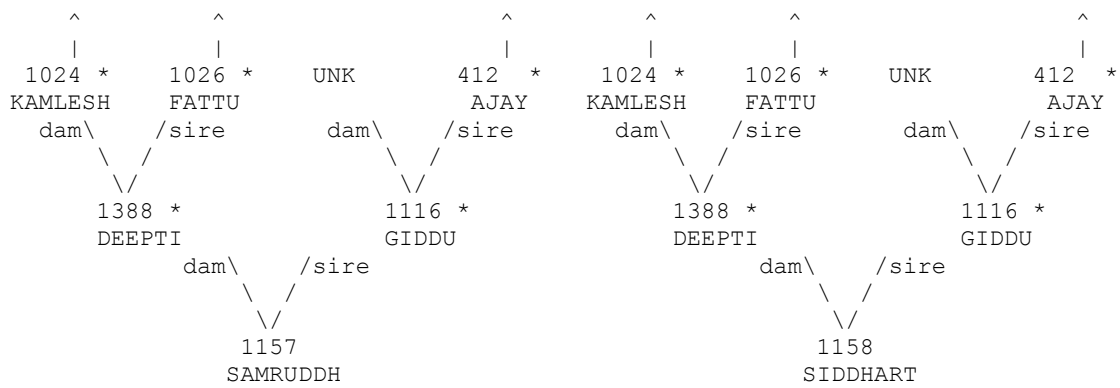

Sex: Female
 Birth Date: 12 Nov 2016
 Last Location: AURANGABA
 House Name: BHAKTI
 Tattoo:
 Tag/Band:

* Appear more than once...
 ^ Pedigree continues beyond top of page...

=====
 Taxon Name: PANTHERA TIGRIS Studbook Number: 1707
 =====

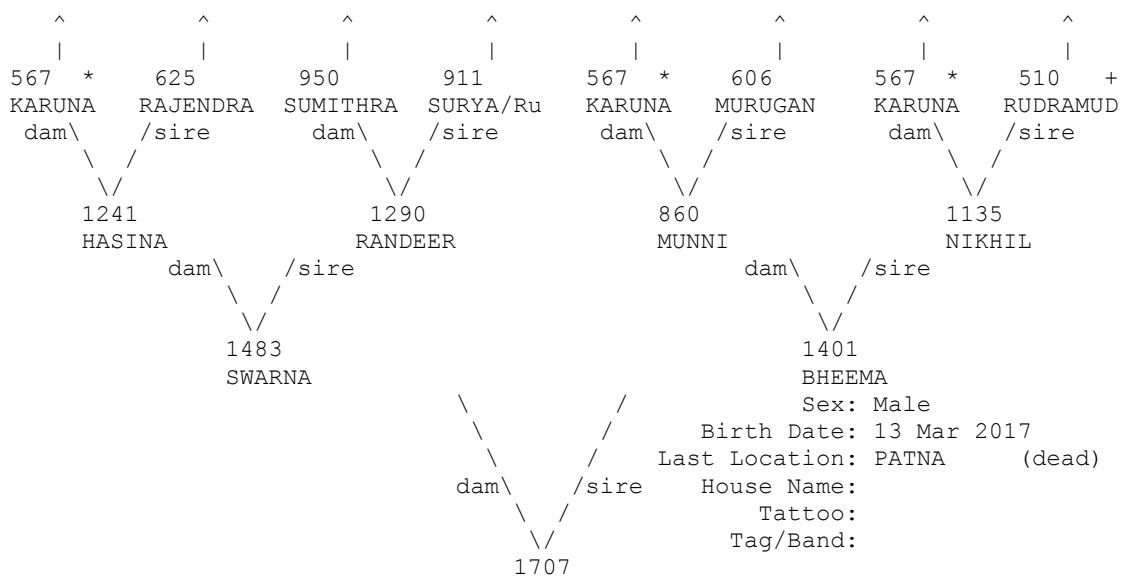

+ Wild-caught... * Appear more than once...
 ^ Pedigree continues beyond top of page...

=====
 Taxon Name: PANTHERA TIGRIS Studbook Number: 1708
 =====

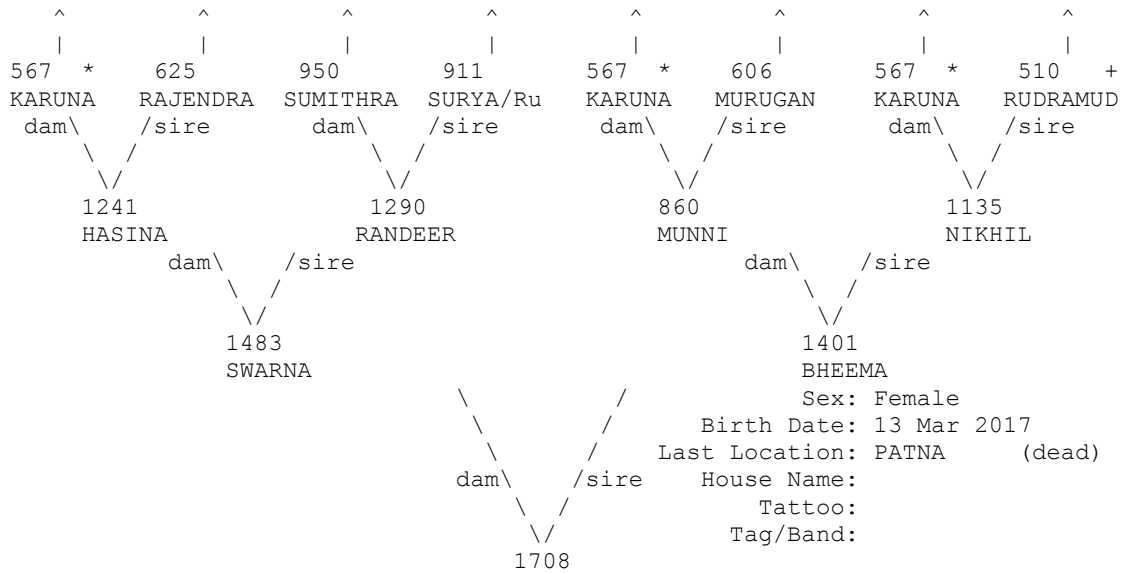

+ Wild-caught... * Appear more than once...
 ^ Pedigree continues beyond top of page...

=====
 Taxon Name: PANTHERA TIGRIS Studbook Number: 1711
 =====

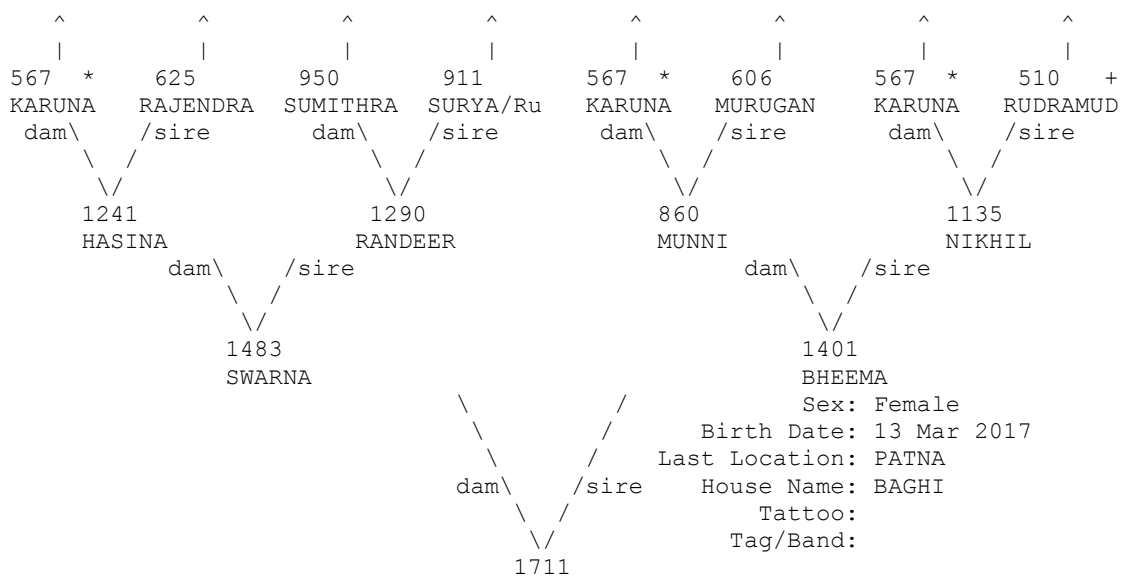

+ Wild-caught... * Appear more than once...
 ^ Pedigree continues beyond top of page...

=====
 Taxon Name: PANTHERA TIGRIS Studbook Number: 1712
 =====

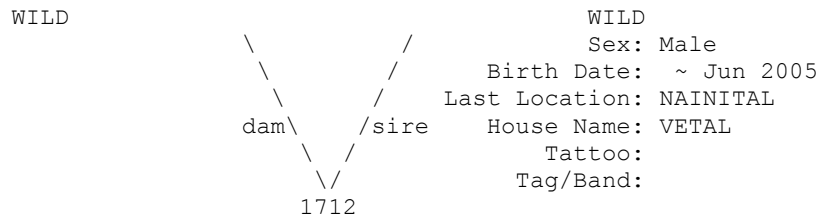

=====
 Taxon Name: PANTHERA TIGRIS Studbook Number: 1713
 =====

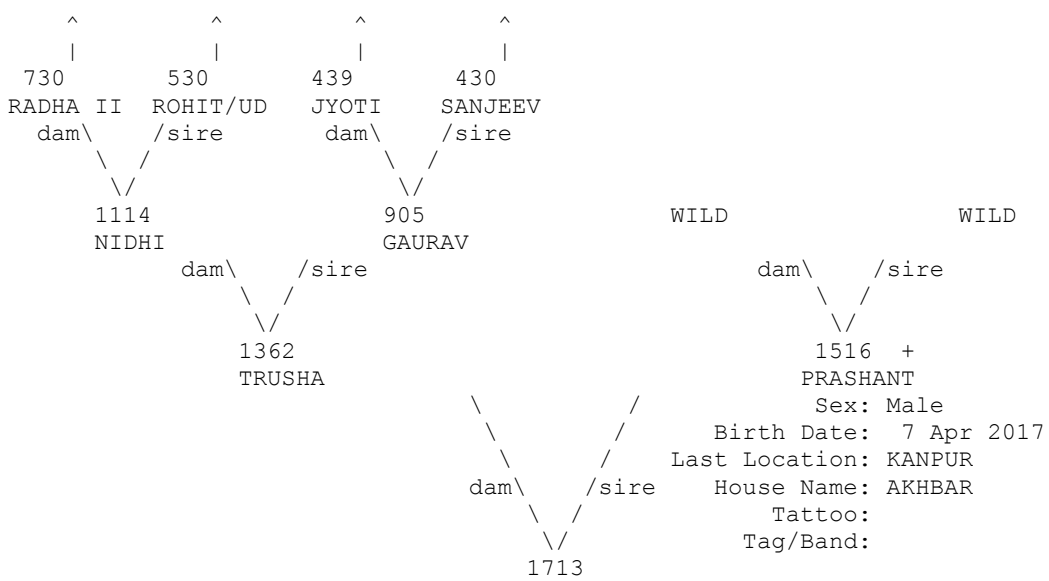

+ Wild-caught... * Appear more than once...
 ^ Pedigree continues beyond top of page...

